



Alcatel-Lucent

Service Router | Release 12.0 R1
7750 SR OS System Management Guide

93-0071-11-01 Edition 02



Alcatel, Lucent, Alcatel-Lucent and the Alcatel-Lucent logo are trademarks of Alcatel-Lucent. All other trademarks are the property of their respective owners. The information presented is subject to change without notice. Alcatel-Lucent assumes no responsibility for inaccuracies contained herein.
Copyright © 2014 Alcatel-Lucent
All Rights Reserved.



This document is protected by copyright. Except as specifically permitted herein, no portion of the provided information can be reproduced in any form, or by any means, without prior written permission from Alcatel-Lucent.
Alcatel, Lucent, Alcatel-Lucent and the Alcatel-Lucent logo are trademarks of Alcatel-Lucent. All other trademarks are the property of their respective owners.
The information presented is subject to change without notice.
Alcatel-Lucent assumes no responsibility for inaccuracies contained herein.

Copyright 2014 Alcatel-Lucent. All rights reserved.

Table of Contents

Preface	13
Getting Started	
Alcatel-Lucent 7750 SR Router Configuration Process	17
Security	
Authentication, Authorization, and Accounting	20
Authentication	21
Local Authentication	22
RADIUS Authentication	22
TACACS+ Authentication	25
Authorization	26
Local Authorization	26
RADIUS Authorization	26
TACACS+ Authorization	27
Accounting	30
RADIUS Accounting	30
TACACS+ Accounting	30
Security Controls	32
When a Server Does Not Respond	32
Access Request Flow	33
CPU Protection	34
CPU Protection Extensions ETH-CFM	38
ETH-CFM Ingress Squelching	40
Distributed CPU Protection (DCP)	43
Applicability of Distributed CPU Protection	45
Log Events, Statistics, Status and SNMP support	46
DCP Policer Resource Management	47
Operational Guidelines and Tips	48
Vendor-Specific Attributes (VSAs)	49
Other Security Features	50
Secure Shell (SSH)	50
Per Peer CPM Queuing	51
CPM Filters and Traffic Management	52
TTL Security for BGP and LDP	53
Exponential Login Backoff	54
User Lockout	55
Encryption	56
802.1x Network Access Control	56
TCP Enhanced Authentication Option	56
Packet Formats	57
Keychain	59
Configuration Notes	60
General	60
Configuring Security with CLI	61
Setting Up Security Attributes	62

Table of Contents

Configuring Authentication	62
Configuring Authorization	63
Configuring Accounting	65
Security Configurations	66
Configuration Tasks	67
Security Configuration Procedures	68
Configuring Management Access Filters	68
Configuring CPM Filters Policy	70
Configuring IPv6 CPM Filters	72
Configuring CPM Queues	73
IPSec Certificates Parameters	74
Configuring Profiles	76
Configuring Users	77
Configuring Keychains	78
Copying and Overwriting Users and Profiles	79
User	79
Profile	81
RADIUS Configurations	83
Configuring RADIUS Authentication	83
Configuring RADIUS Authorization	84
Configuring RADIUS Accounting	85
Configuring 802.1x RADIUS Policies	86
Configuring CPU Protection Policies	87
TACACS+ Configurations	88
Enabling TACACS+ Authentication	88
Configuring TACACS+ Authorization	89
Configuring TACACS+ Accounting	90
Enabling SSH	91
Configuring Login Controls	92
Security Command Reference	93
Command Hierarchies	93
Configuration Commands	93
LLDP Commands	94
Configuration Commands	111
General Security Commands	111
LLDP Commands	116
Login, Telnet, SSH and FTP Commands	119
Management Access Filter Commands	125
Password Commands	140
Public Key Infrastructure (PKI) Commands	149
Profile Management Commands	160
User Management Commands	164
RADIUS Client Commands	172
TACACS+ Client Commands	178
Generic 802.1x COMMANDS	182
TCP Enhanced Authentication	185
CPM Filter Commands	190
CPM Queue Commands	206
TTL Security Commands	208

CPU Protection Commands	210
Distributed CPU Protection Commands	219
Show Commands	229
Security Commands	229
Login Control	269
Clear Commands	270
CPU Protection Commands	272
Debug Commands	274
Tools Commands	275
Admin Commands	277
SNMP	
SNMP Overview	280
SNMP Architecture	280
Management Information Base	280
SNMP Protocol Operations	281
SNMP Versions	281
Management Information Access Control	282
User-Based Security Model Community Strings	283
Views	283
Access Groups	283
Users	284
Which SNMP Version to Use?	285
Configuration Notes	287
General	287
Configuring SNMP with CLI	289
SNMP Configuration Overview	290
Configuring SNMPv1 and SNMPv2c	290
Configuring SNMPv3	290
Basic SNMP Security Configuration	291
Configuring SNMP Components	292
Configuring a Community String	293
Configuring View Options	294
Configuring Access Options	295
Configuring USM Community Options	297
Configuring Other SNMP Parameters	298
SNMP Command Reference	299
Command Hierarchies	299
Configuration Commands	299
Configuration Commands	301
SNMP System Commands	301
SNMP Security Commands	304
Show Commands	311
Event and Accounting Logs	
Logging Overview	332
Log Destinations	334
Console	334
Session	334
Memory Logs	334

Table of Contents

Log Files	335
SNMP Trap Group	337
Syslog	337
Event Logs	339
Event Sources	340
Event Control	341
Log Manager and Event Logs	343
Event Filter Policies	344
Event Log Entries	345
Simple Logger Event Throttling	347
Default System Log	348
Accounting Logs	349
Accounting Records	349
Accounting Files	365
Design Considerations	365
Reporting and Time-Based Accounting	366
Overhead Reduction in Accounting: Custom Record	367
User Configurable Records	367
Changed Statistics Only	367
Configurable Accounting Records	368
Significant Change Only Reporting	368
Immediate Completion of Records	370
AA Accounting per Forwarding Class	370
Configuration Notes	371
Configuring Logging with CLI	373
Log Configuration Overview	374
Log Types	374
Basic Event Log Configuration	375
Common Configuration Tasks	376
Configuring an Event Log	376
Configuring a File ID	378
Configuring an Accounting Policy	379
Configuring Event Control	380
Configuring Throttle Rate	381
Configuring a Log Filter	382
Configuring an SNMP Trap Group	383
Setting the Replay Parameter	385
Shutdown In-Band Port	387
No Shutdown Port	389
Configuring a Syslog Target	391
Configuring an Accounting Custom Record	392
Log Management Tasks	394
Modifying a Log File	395
Deleting a Log File	397
Modifying a File ID	398
Deleting a File ID	399
Modifying a Syslog ID	400
Deleting a Syslog	401
Modifying an SNMP Trap Group	402

Deleting an SNMP Trap Group	403
Modifying a Log Filter	404
Deleting a Log Filter	406
Modifying Event Control Parameters	407
Returning to the Default Event Control Configuration	408
Log Command Reference	409
Command Hierarchies	409
Configuration Commands	419
Generic Commands	419
Log File Commands	424
Log Filter Commands	427
Log Filter Entry Commands	428
Log Filter Entry Match Commands	430
Syslog Commands	434
SNMP Trap Groups	439
Accounting Policy Commands	448
Show Commands	475
Clear Commands	497
Facility Alarms	
Facility Alarms Overview	500
Facility Alarms vs. Log Events	501
Facility Alarm Severities and Alarm LED Behavior	503
Facility Alarm Hierarchy	504
Facility Alarm List	505
Configuring Logging with CLI	513
Basic Facility Alarm Configuration	514
Common Configuration Tasks	515
Configuring the Maximum Number of Alarms To Clear	515
Facility Alarms Command Reference	517
Command Hierarchies	517
Configuration Commands	519
Generic Commands	519
Show Commands	521
Standards and Protocol Support	523
Index	529

Table of Contents

List of Tables

Getting Started

Table 1:	Configuration Process	17
----------	-----------------------------	----

Security

Table 2:	Supported Authorization Configurations	27
Table 3:	Security Methods Capabilities	32
Table 4:	Ranges versus Levels and OpCodes	38
Table 5:	CPU PRotection and Squelching	41
Table 6:	Keychain Mapping	59
Table 7:	Security Configuration Requirements	67
Table 8:	Opcode Values	132
Table 9:	IP Protocol Names	193
Table 10:	Show System Security Access Group Output Fields	229
Table 11:	Show System Security Authentication Output Fields	230
Table 12:	Show Communities Output Fields	233
Table 13:	Show CPM IP Filter Output Fields	234
Table 14:	Show CPM IPv6 Filter Output Fields	236
Table 15:	Show CPM IPv6 Filter Output Fields	238
Table 16:	Show Distributed CPU Protection Output Fields	245
Table 17:	Show Distributed CPU Protection Policer Output Fields	246
Table 18:	Show Distributed CPU Protection Policer Output Fields	249
Table 19:	Show Management Access Filter Output Fields	257
Table 20:	Show Management Access Filter Output Fields	259
Table 21:	Show Per-Peer-Queuing Output Fields	260
Table 22:	Show User Profile Output Fields	261
Table 23:	Show Source Address Output Fields	262
Table 24:	Show View Output Fields	266
Table 25:	Show Users Output Fields	269
Table 26:	Output Parameters	276

SNMP

Table 27:	Counters Output Fields	311
Table 28:	Counters Output Fields	312
Table 29:	Show System Information Output Fields	313
Table 30:	Show System Security Access-Group Output Fields	317
Table 31:	Show Communities Output Fields	320
Table 32:	Show SSH Output Fields	325
Table 33:	Show User Output Fields	326
Table 34:	Show System Security View Output Fields	328

Event and Accounting Logs

Table 35:	Event Severity Levels	332
Table 36:	Router to Syslog Severity Level Mappings	338
Table 37:	Valid Filter Policy Operators	344
Table 38:	Log Entry Field Descriptions	345
Table 39:	Accounting Record Name and Collection Periods	349

List of Tables

Table 40:	Accounting Record Name Details	350
Table 41:	Policer Stats Field Descriptions	362
Table 42:	Queue Group Record Types	363
Table 43:	Queue Group Record Type Fields	363
Table 44:	Show Accounting Policy Output Fields	475
Table 45:	Accounting Policy Output Fields	477
Table 46:	Event Log Filter Summary Output Fields	485
Table 47:	Event Log Filter Detail Output Fields	485
Table 48:	Log Filter Match Criteria Output Fields	486
Table 49:	Show Log-Collector Output Fields	488
Table 50:	SNMP Trap Group Output Fields	493
Table 51:	Show Log Syslog Output Fields	495

Facility Alarms

Table 52:	Alarm, Alarm Name/Raising Event, Sample Details String and Clearing Event	505
Table 53:	Alarm Name/Raising Event, Cause, Effect and Recovery	507
Table 54:	linkDown Facility Alarm Support	511
Table 55:	Show Facility Alarms Output Fields	521

LIST OF FIGURES

Security

Figure 1:	RADIUS Requests and Responses	20
Figure 2:	Security Flow	33
Figure 3:	Profile Marking	35
Figure 4:	ETH-CFM Hierarchical Model	40
Figure 5:	Per SAP per Protocol Static Rate Limiting with DCP	44
Figure 6:	Per Network Interface per Protocol Static Rate Limiting with DCP	44

SNMP

Figure 7:	SNMPv1 and SNMPv2c Configuration and Implementation Flow	286
-----------	--	-----

Event and Accounting Logs

Figure 8:	Event Logging Block Diagram	339
-----------	-----------------------------------	-----

Facility Alarms

Figure 9:	Log Events, Alarms and LEDs	501
-----------	-----------------------------------	-----

About This Guide

This guide describes management of SR OS routers including access to the router (AAA, CLI, SNMP), basic router security, logs, notifications and facility alarms.

This document is organized into functional chapters and provides concepts and descriptions of the implementation flow, as well as Command Line Interface (CLI) syntax and command usage.

Audience

This manual is intended for network administrators who are responsible for configuring the basic management infrastructure of SR OS routers. It is assumed that the network administrators have an understanding of networking principles and configurations. Protocols and concepts described in this manual include the following:

- User Authentication, Authorization and Accounting (AAA including TACACS+ and RADIUS)
- CPU Protection features for router security and protection against Denial Of Service (DoS) attacks
- SNMP for configuration and operational status
- Event logs (local, syslog, SNMP notifications)
- XML Accounting files for bulk stats collection
- Facility Alarms for equipment monitoring

List of Technical Publications

The 7750 SR documentation set is composed of the following books:

- **7750 SR OS Basic System Configuration Guide**
This guide describes basic system configurations and operations.
- **7750 SR OS System Management Guide**
This guide describes system security and access configurations as well as event logging and accounting logs.
- **7750 SR OS Interface Configuration Guide**
- **7750 SR OS Router Configuration Guide**
This guide describes logical IP routing interfaces and associated attributes such as an IP address, as well as IP and MAC-based filtering, and VRRP and Cflowd.
- **7750 SR OS Routing Protocols Guide**
This guide provides an overview of routing concepts and provides configuration examples for RIP, OSPF, IS-IS, BGP, and route policies.
- **7750 SR OS MPLS Guide**
This guide describes how to configure Multiprotocol Label Switching (MPLS) and Label Distribution Protocol (LDP).
- **7750 SR OS Services Guide**
This guide describes how to configure service parameters such as service distribution points (SDPs), customer information, and user services.
- **7750 SR OAM and Diagnostic Guide**
This guide describes how to configure features such as service mirroring and Operations, Administration and Management (OAM) tools.
- **7750 SR OS Triple Play Guide**
This guide describes Triple Play services and support provided by the 7750 SR and presents examples to configure and implement various protocols and services.
- **7750 SR OS Quality of Service Guide**
This guide describes how to configure Quality of Service (QoS) policy management.
- **OS Multi-Service ISA Guide**
This guide describes services provided by integrated service adapters such as Application Assurance, IPSec, ad insertion (ADI) and Network Address Translation (NAT).
- **7750 SR-OS RADIUS Attributes Reference Guide**

This guide describes all supported RADIUS Authentication, Authorization and Accounting attributes.

Technical Support

If you purchased a service agreement for your router and related products from a distributor or authorized reseller, contact the technical support staff for that distributor or reseller for assistance.

If you purchased an Alcatel-Lucent service agreement, contact technical assistance at:

<http://www.alcatel-lucent.com/wps/portal/support>

Report documentation errors, omissions and comments to:

Documentation.feedback@alcatel-lucent.com

Include document name, version, part number and page(s) affected.

Getting Started

In This Chapter

This chapter provides process flow information to configure system security and access functions as well as event and accounting logs.

Alcatel-Lucent 7750 SR Router Configuration Process

[Table 1](#) lists the tasks necessary to configure system security and access functions and logging features. Each chapter in this book is presented in an overall logical configuration flow. Each section describes a software area and provides CLI syntax and command usage to configure parameters for a functional area.

Table 1: Configuration Process

Area	Task	Chapter
System security	Configure system security parameters, such as authentication, authorization, and accounting.	Security on page 19
Network management	Configure SNMP elements.	SNMP on page 279
Operational functions	Configure event and accounting logs.	Event and Accounting Logs on page 331
Reference	List of IEEE, IETF, and other proprietary entities.	Standards and Protocol Support on page 523

In This Chapter

This chapter provides information to configure security parameters. Topics in this chapter include:

- [Authentication, Authorization, and Accounting on page 20](#)
 - [Authentication on page 21](#)
 - [Authorization on page 26](#)
 - [Accounting on page 30](#)
- [Security Controls on page 32](#)
 - [When a Server Does Not Respond on page 32](#)
 - [Access Request Flow on page 33](#)
- [CPU Protection on page 34](#)
- [Vendor-Specific Attributes \(VSAs\) on page 49](#)
- [Other Security Features on page 50](#)
 - [CPM Filters and Traffic Management on page 52](#)
 - [Secure Shell \(SSH\) on page 50](#)
 - [Encryption on page 56](#)
- [Configuration Notes on page 60](#)

Authentication, Authorization, and Accounting

This chapter describes authentication, authorization, and accounting (AAA) used to monitor and control network access on routers. Network security is based on a multi-step process. The first step, authentication, validates a user's name and password. The second step is authorization, which allows the user to access and execute commands at various command levels based on profiles assigned to the user.

Another step, accounting, keeps track of the activity of a user who has accessed the network. The type of accounting information recorded can include a history of the commands executed, the amount of time spent in the session, the services accessed, and the data transfer size during the session. The accounting data can then be used to analyze trends, and also for billing and auditing purposes.

You can configure routers to use local, Remote Authentication Dial In User Service (RADIUS), or Terminal Access Controller Access Control System Plus (TACACS+) security to validate users who attempt to access the router by console, Telnet, or FTP. You can select the authentication order which determines the authentication method to try first, second, and third.

The router supports the following security features:

- RADIUS can be used for authentication, authorization, and accounting.
- TACACS+ can be used for authentication, authorization, and accounting.
- Local security can be implemented for authentication and authorization.

Figure 1 depicts end user access-requests sent to a RADIUS server. After validating the user names and passwords, the RADIUS server returns an access-accept message to the users on ALA-1 and ALA-2. The user name and password from ALA-3 could not be authenticated, thus access was denied.

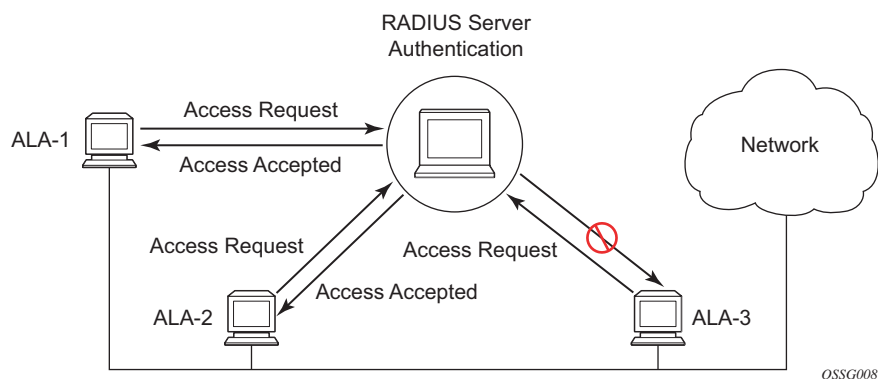

Figure 1: RADIUS Requests and Responses

Authentication

Authentication validates a user name and password combination when a user attempts to log in.

When a user attempts to log in through the console, Telnet, SSH, SCP, or FTP, the client sends an access request to a RADIUS, TACACS+, or local database.

Transactions between the client and a RADIUS server are authenticated through the use of a shared secret. The secret is never transmitted over the network. User passwords are sent encrypted between the client and RADIUS server which prevents someone snooping on an insecure network to learn password information.

If the RADIUS server does not respond within a specified time, the router issues the access request to the next configured servers. Each RADIUS server must be configured identically to guarantee consistent results.

If any RADIUS server rejects the authentication request, it sends an access reject message to the router. In this case, no access request is issued to any other RADIUS servers. However, if other authentication methods such as TACACS+ and/or local are configured, then these methods are attempted. If no other authentication methods are configured, or all methods reject the authentication request, then access is denied.

For the RADIUS server selection, round-robin is used if multiple RADIUS servers are configured. Although, if the first alive server in the list cannot find a user-name, the router does not re-query the next server in the RADIUS server list and denies the access request. It may get authenticated on the next login attempt if the next selected RADIUS server has the appropriate user-name. It is recommended that the same user databases are maintained for RADIUS servers in order to avoid inconsistent behavior.

The user login is successful when the RADIUS server accepts the authentication request and responds to the router with an access accept message.

Implementing authentication without authorization for the routers does not require the configuration of VSAs (Vendor Specific Attributes) on the RADIUS server. However, users, user access permissions, and command authorization profiles must be configured on each router.

Any combination of these authentication methods can be configured to control network access from a router:

- [Local Authentication on page 22](#)
- [RADIUS Authentication on page 22](#)
- [TACACS+ Authentication on page 25](#)

Local Authentication

Local authentication uses user names and passwords to authenticate login attempts. The user names and passwords are local to each router not to user profiles.

By default, local authentication is enabled. When one or more of the other security methods are enabled, local authentication is disabled. Local authentication is restored when the other authentication methods are disabled. Local authentication is attempted if the other authentication methods fail and local is included in the authentication order password parameters.

Locally, you can configure user names and password management information. This is referred to as local authentication. Remote security servers such as RADIUS or TACACS+, are not enabled.

RADIUS Authentication

Remote Authentication Dial-In User Service (RADIUS) is a client/server security protocol and software that enables remote access servers to communicate with a central server to authenticate dial-in users and authorize access to the requested system or service.

RADIUS allows you to maintain user profiles in a shared central database and provides better security, allowing a company to set up a policy that can be applied at a single administered network point.

RADIUS Server Selection

The RADIUS server selection algorithm is used by different applications:

- RADIUS operator management
- RADIUS authentication for Enhanced Subscriber Management
- RADIUS accounting for Enhanced Subscriber Management
- RADIUS PE-discovery

In all these applications, up to 5 RADIUS servers pools (per RADIUS policy, if used) can be configured.

The RADIUS server selection algorithm can work in 2 modes, either Direct mode or Round-robin mode.

Direct Mode

The first server is used as the primary server. If this server is unreachable, the next server, based on the server index, of the server pool is used. This continues until either all servers in the pool have been tried or an answer is received.

If a server is unreachable, it will not be used again by the RADIUS application for the next 30 seconds to allow the server to recover from its unreachable state. After 30 seconds the unreachable server is available again for the RADIUS application. If in these 30 seconds the RADIUS application receives a valid response for a previously sent RADIUS packet on that unreachable server, the server will be available for the RADIUS application again, immediately after reception of that response.

Round-Robin Mode

The RADIUS application sends the next RADIUS packet to the next server in the server pool. The same server non-reachability behavior is valid as in the Direct mode.

Server Reachability Detection

A server is reachable, when the operational state UP, when a valid response is received within a timeout period which is configurable by the retry parameter on the RADIUS policy level.

A server is treated as not-reachable, when the operational state down, when the following occurs:

- A timeout — If a number of consecutive timeouts are encountered for a specific server. This number is configurable by the retry parameter on RADIUS policy level.
- A send failed — If a packet cannot be sent to the RADIUS server because the forwarding path towards the RADIUS server is broken (for example, the route is not available, the interface shutdown, etc.), then, no retry mechanism is invoked and immediately, the next server in line is used.

A server that is down can only be used again by the RADIUS algorithm after 30 seconds, unless, during these 30 seconds a valid RADIUS reply is received for that server. Then, the server is immediately marked UP again.

The operational state of a server can also be “unknown” if the RADIUS application is not aware of the state of the RADIUS server (for example, if the server was previously down but no requests had been sent to the server, thus, it is not certain yet whether the server is actually reachable).

Application Specific Behavior

Operator Management

The server access mode is fixed to Round-Robin (Direct cannot be configured for operator management). A health-check function is available for operator management, which can optionally be disabled. The health-check polls the server once every 10 seconds with an improbable user name. If the server does not respond to this health-check, it will be marked down.

If the first server in the list cannot find a user, the next server in the RADIUS server list is not queried and access is denied. If multiple RADIUS servers are used, it is assumed they all have the same user database.

RADIUS Authentication

If the first server in the list cannot find a user, the next server in the RADIUS server list is not queried and access is denied. If multiple RADIUS servers are used, it is assumed they all have the same user database.

RADIUS Accounting

The RADIUS accounting application will try to send all the concerned packets of a subscriber host to the same server. If that server is down, then the packet is sent to the next server and, from that moment on, the RADIUS application uses that server to send its packets for that subscriber host.

RADIUS PE-Discovery

If the first server in the list cannot find a user, the next server in the RADIUS server list is not queried and access is denied. If multiple RADIUS servers are used, it is assumed they all have the same user database.

The RADIUS PE-discovery application makes use of a 10 second time period instead of the generic 30 seconds and uses a fixed consecutive timeout value of 2 (see [Server Reachability Detection on page 23](#)).

As long as the Session-Timeout (attribute in the RADIUS user file) is specified, it is used for the polling interval. Otherwise, the configured polling interval will be used (60 seconds by default).

TACACS+ Authentication

Terminal Access Controller Access Control System, commonly referred to as TACACS is an authentication protocol that allows a remote access server to forward a user's logon password to an authentication server to determine whether access can be allowed to a given system. TACACS is an encryption protocol and therefore less secure than the later Terminal Access Controller Access Control System Plus (TACACS+) and RADIUS protocols.

TACACS+ and RADIUS have largely replaced earlier protocols in the newer or recently updated networks. TACACS+ uses Transmission Control Protocol (TCP) and RADIUS uses the User Datagram Protocol (UDP). TACACS+ is popular as TCP is thought to be a more reliable protocol. RADIUS combines authentication and authorization. TACACS+ separates these operations.

Authorization

SR OS routers support local, RADIUS, and TACACS+ authorization to control the actions of specific users. Any combination of these authorization methods can be configured to control actions of specific users:

- [Local Authorization on page 26](#)
- [RADIUS Authorization on page 26](#)
- [TACACS+ Authorization on page 27](#)

Local authorization and RADIUS authorization operate by applying a profile based on user name and password configurations once network access is granted. The profiles are configured locally as well as VSAs on the RADIUS server. See [Vendor-Specific Attributes \(VSAs\) on page 49](#).

Local Authorization

Local authorization uses user profiles and user access information after a user is authenticated. The profiles and user access information specifies the actions the user can and cannot perform.

By default, local authorization is enabled. Local authorization is disabled only when a different remote authorization method is configured, such as TACACS+ or RADIUS authorization.

You must configure profile and user access information locally.

RADIUS Authorization

RADIUS authorization grants or denies access permissions for a router. Permissions include the use of FTP, Telnet, SSH (SCP), and console access. When granting Telnet, SSH (SCP) and console access to the router, authorization can be used to limit what CLI commands the user is allowed to issue and which file systems the user is allowed or denied access.

Once a user has been authenticated using RADIUS (or another method), the router can be configured to perform authorization. The RADIUS server can be used to:

- Download the user profile to the router
- Send the profile name that the node should apply to the router.

Profiles consist of a suite of commands that the user is allowed or not allowed to execute. When a user issues a command, the authorization server looks at the command and the user information and compares it with the commands in the profile. If the user is authorized to issue the command, the command is executed. If the user is not authorized to issue the command, then the command is not executed.

Profiles must be created on each router and should be identical for consistent results. If the profile is not present, then access is denied.

[Table 2](#) displays the following scenarios:

- Remote (RADIUS) authorization cannot be performed if authentication is done locally (on the router).
- The reverse scenario is supported if RADIUS authentication is successful and no authorization is configured for the user on the RADIUS server, then local (router) authorization is attempted, if configured in the authorization order.

When authorization is configured and profiles are downloaded to the router from the RADIUS server, the profiles are considered temporary configurations and are not saved when the user session terminates.

Table 2: Supported Authorization Configurations

	Router	RADIUS Supplied Profile
Router configured user	Supported	Not Supported
RADIUS server configured user	Supported	Supported
TACACS+ server configured user	Supported	Not Supported

When using authorization, maintaining a user database on the router is not required. User names can be configured on the RADIUS server. User names are temporary and are not saved in the configuration when the user session terminates. Temporary user login names and their associated passwords are not saved as part of the configuration.

TACACS+ Authorization

TACACS+ authorization operates in one of three ways:

- All users who authenticate via TACACS+ can use a single common default profile that is configured on the SR OS Router, or
- Each command attempted by a user is sent to the TACACS+ server for authorization

- The operator can configure local profiles and map **tacplus priv-lvl** based authorization to those profiles (the **use-priv-lvl** option)

To use a single common default profile to control command authorization for TACACS+ users, the operator must configure the **tacplus use-default-template** option and configure the parameters in the **tacplus_default user-template** to point to a valid local profile.

If the default template is not being used for TACACS+ authorization and the **use-priv-lvl** option is not configured, then each CLI command issued by an operator is sent to the TACACS+ server for authorization. The authorization request sent by SR OS contains the first word of the CLI command as the value for the TACACS+ **cmd** and all following words become a **cmd-arg**. Quoted values are expanded so that the quotation marks are stripped off and the enclosed value are seen as one **cmd** or **cmd-arg**.

Examples

Here is a set of examples, where the following commands are typed in the CLI:

- "show"
- "show router"
- "show port 1/1/1"
- "configure port 1/1/1 description "my port"

This results in the following AVPairs:

```
cmd=show

cmd=show
cmd-arg=router

cmd=show
cmd-arg=port
cmd-arg=1/1/1

cmd=configure
cmd-arg=port
cmd-arg=1/1/1
cmd-arg=description
cmd-arg=my port
```

For TACACS+ authorization, SR OS sends the entire CLI context in the **cmd** and **cmd-arg** values. Here is a set of examples where the CLI context is different:

```
- *A:dut-c# configure service
- *A:dut-c>config>service# vprn 555 customer 1 create
- *A:dut-c>config>service>vprn$ shutdown
```

This results in the following AVPairs:

```
cmd =configure
cmd-arg=service
```

```
cmd=configure
cmd-arg=service
cmd-arg=vprn
cmd-arg="555"
cmd-arg=customer
cmd-arg=1
cmd-arg=create
```

```
cmd=configure
cmd-arg=service
cmd-arg=vprn
cmd-arg="555"
cmd-arg=customer
cmd-arg=1
cmd-arg=create
cmd-arg=shutdown
```

Accounting

When enabled, RADIUS accounting sends command line accounting from the router to the RADIUS server. The router sends spar

s using UDP packets at port 1813 (decimal).

The router issues an accounting request packet for each event requiring the activity to be recorded by the RADIUS server. The RADIUS server acknowledges each accounting request by sending an accounting response after it has processed the accounting request. If no response is received in the time defined in the timeout parameter, the accounting request must be retransmitted until the configured retry count is exhausted. A trap is issued to alert the NMS (or trap receiver) that the server is unresponsive. The router issues the accounting request to the next configured RADIUS server (up to 5).

User passwords and authentication keys of any type are never transmitted as part of the accounting request.

RADIUS Accounting

Accounting tracks user activity to a specified host. When RADIUS accounting is enabled, the server is responsible for receiving accounting requests and returning a response to the client indicating that it has successfully received the request. Each command issued on the router generates a record sent to the RADIUS server. The record identifies the user who issued the command and the timestamp.

Accounting can be configured independently from RADIUS authorization and RADIUS authentication.

TACACS+ Accounting

The OS allows you to configure the type of accounting record packet that is to be sent to the TACACS+ server when specified events occur on the device. The accounting **record-type** parameter indicates whether TACACS+ accounting start and stop packets be sent or just stop packets be sent. Start/stop messages are only sent for individual commands, not for the session.

When a user logs in to request access to the network using Telnet or SSH, or a user enters a command for which accounting parameters are configured, or a system event occurs, such as a reboot or a configuration file reload, the router checks the configuration to see if TACACS+ accounting is required for the particular event.

If TACACS+ accounting is required, then, depending on the accounting record type specified, sends a start packet to the TACACS+ accounting server which contains information about the event.

The TACACS+ accounting server acknowledges the start packet and records information about the event. When the event ends, the device sends a stop packet. The stop packet is acknowledged by the TACACS+ accounting server.

Security Controls

You can configure routers to use RADIUS, TACACS+, and local authentication to validate users requesting access to the network. The order in which password authentication is processed among RADIUS, TACACS+ and local passwords can be specifically configured. In other words, the authentication order can be configured to process authorization through TACACS+ first, then RADIUS for authentication and accounting. Local access can be specified next in the authentication order in the event that the RADIUS and TACACS+ servers are not operational.

Table 3: Security Methods Capabilities

Method	Authentication	Authorization	Accounting*
Local	Y	Y	N
TACACS+	Y	Y	Y
RADIUS	Y	Y	Y

* Local commands always perform account logging using the **config log** command.

When a Server Does Not Respond

A trap is issued if a RADIUS + server is unresponsive. An alarm is raised if RADIUS is enabled with at least one RADIUS server and no response is received to either accounting or user access requests from any server.

Periodic checks to determine if the primary server is responsive again are not performed. If a server is down, it will not be contacted for 5 minutes. If a login is attempted after 5 minutes, then the server is contacted again. When a server does not respond with the health check feature enabled, the server's status is checked every 30 seconds. Health check is enabled by default. When a service response is restored from at least one server, the alarm condition is cleared. Alarms are raised and cleared on Alcatel-Lucent's Fault Manager or other third party fault management servers.

The servers are accessed in order from lowest to highest specified index (from 1 to 5) for authentication requests until a response from a server is received. A higher indexed server is only queried if no response is received, implying a lower indexed server is not available. If a response from the server is received, no other server is queried.

Access Request Flow

In [Figure 2](#), the authentication process is defined in the `config>system>security>password` context. The authentication order is determined by specifying the sequence in which password authentication is attempted among RADIUS, TACACS+, and local passwords. This example uses the authentication order of RADIUS, then TACACS+, and finally, local. An access request is sent to RADIUS server 1. One of two scenarios can occur. If there is no response from the server, the request is passed to the next RADIUS server with the next lowest index (RADIUS server 2) and so on, until the last RADIUS server is attempted (RADIUS server 5). If server 5 does not respond, the request is passed to the TACACS+ server 1. If there is no response from that server, the request is passed to the next TACACS+ server with the next lowest index (TACACS+ server 2) and so on.

If a request is sent to an active RADIUS server and the user name and password is not recognized, access is denied and passed on to the next authentication option, in this case, the TACACS+ server. The process continues until the request is either accepted, denied, or each server is queried. Finally, if the request is denied by the active TACACS+ server, the local parameters are checked for user name and password verification. This is the last chance for the access request to be accepted.

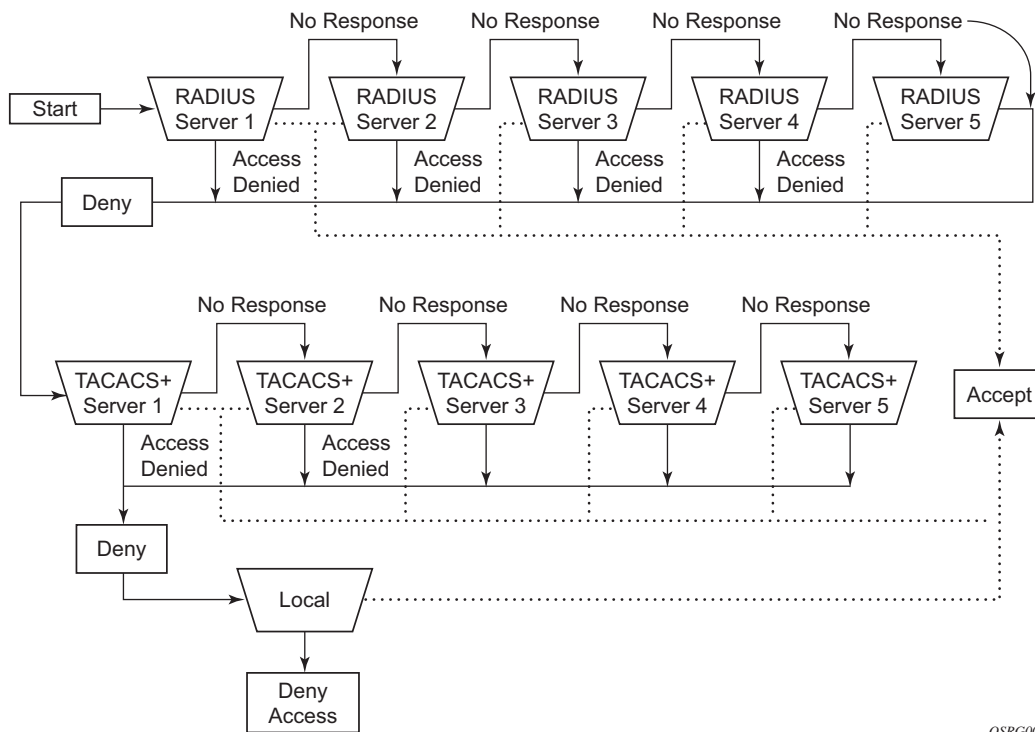

OSRG009

Figure 2: Security Flow

CPU Protection

SR OS provides several rate limiting mechanisms to protect the CPM/CFM processing resources of the router:

- CPU Protection: A centralized rate limiting function that operates on the CPM to limit traffic destined to the CPUs.
- Distributed CPU Protection: A control traffic rate limiting protection mechanism for the CPM/CFM that operates on the line cards (hence ‘distributed’).

CPU protection protects the CPU of the node that it is configured on from a DOS attack by limiting the amount of traffic coming in from one of its ports and destined to the CPM (to be processed by its CPU) using a combination of the configurable limits.

Some of the limits are configured globally for the node, and some of the limits are configured in CPU Protection profiles which are assigned to interfaces.

The following limits are configured globally for the node:

- link-specific rate — Applies to the link-specific protocols LACP (ethernet LAG control) and LMI (ATM, Ethernet and Frame Relay). The rate is a per-link limit (each link in the system will have LACP/LMI packets limited to this rate).
- port-overall-rate – Applies to all control traffic each port. The rate is a per-port limit (each port in the system will have control traffic destined to the CPM limited to this rate).
- protocol-protection — Blocks network control traffic for unconfigured protocols. If IS-IS is not configured on an IP interface all IS-IS-related traffic will be dropped and not reach the CPU.

The following limits are configured within CPU Protection policies (1-255). CPU Protection policies are created, configured, and then assigned to interfaces.

- overall-rate — Applies to all control traffic destined to the CPM (all sources) received on the interface (only where the policy is applied). This is a per-interface limit. Control traffic received above this rate will be discarded.
- per-source-rate — Used to limit the control traffic destined to the CPM from each individual source. This per-source-rate is only applied when an object (SAP) is configured with a `cpu-protection` policy and also with the optional `mac-monitoring` or `ip-src-monitoring` keywords. A source is defined as a *SAP, Source MAC Address* tuple for `mac-monitoring` and as a *SAP, Source IP Address* tuples for `ip-src-monitoring`. Only certain protocols (as configured under *included-protocols* in the `cpu` protection policy) are limited (per source) when the `ip-src-monitoring` keyword is used.
- out-profile-rate – Applies to all control traffic destined to the CPM (all sources) received on the interface (only where the policy is applied). This is a per-interface

limit. Control traffic received above this rate will be marked as discard eligible and is more likely to be discarded if there is contention for CPU resources.

A three-color marking mechanism uses a green, yellow and red marking function. This allows greater flexibility in how traffic limits are implemented. A CLI command within the DoS protection policy called **out-profile-rate** maps to the boundary between the green (accept) and yellow (mark as discard eligible) regions. The **overall-rate** command marks the boundary between the yellow and red (drop) regions point for the associated policy (Figure 3).



Figure 3: Profile Marking

There are two default CPU protection policies. They are modifiable, but cannot be deleted.

Policy 254:

- This is the default policy that is automatically applied to access interfaces
- Traffic above 6000 pps is discarded
- overall-rate = 6000
- per-source-rate = max
- out-profile-rate = 6000

Policy 255:

- This is the default policy that is automatically applied to Network interfaces
- Traffic above 3000 pps is marked as discard eligible, but is not discarded unless there is congestion in the queueing towards the CPU
- overall-rate = max
- per-source-rate = max
- out-profile-rate = 3000

All traffic destined to the CPM and that will be processed by its CPU will be subject to the limit specified. Therefore, if there is a protocol running on the violating interface, then protocol traffic on that interface will be affected. The objective of CPU protection is to limit the amount of traffic that the CPU will process at an early stage, therefore, the good and bad

traffic coming in cannot be distinguished when it arrives at a rate higher than the user-configured limit.

If the overall rate is set to 1000 pps and as long as the total traffic that is destined to the CPM and intended to be processed by the CPU is less than or equal to 1000 pps, all traffic will be processed. If the rate exceeds 1000 pps, then protocol traffic is discarded (or marked as discard eligible in the case of the out-profile-rate) and traffic on the interface is affected.

This protects all the other interfaces on the system and make sure that a violation from one interface does not affect the rest of the box.

The protocol-protection configuration is not a rate (just an enable/disable configuration). When enabled, this feature causes the network processor on the CPM to discard all packets received for protocols that are not configured on the particular interface. This helps mitigate DoS attacks by filtering invalid control traffic before it hits the CPU. The system automatically populates and maintains a per-interface list of configured (such as valid) protocols (based on interface config, etc). For example, if an interface does not have IS-IS configured, then protocol-protection will discard any IS-IS packets received on that interface.

Some protocols are not bound to a specific interface, for example, BGP. SR-OS will discard packets for these protocols if the protocol is not configured anywhere in the system. Note that protection for the following protocols is achieved using the per-peer-queueing feature of SR-OS: BGP, T-LDP, LDP, MSDP.

Protocols controlled by the protocol-protection mechanism include:

- OSPFv2
- OSPFv3
- IS-IS
- RSVP-TE
- RIP
- PIM
- MLD
- IGMP
- L2TP
- PPP

Note: If PIM or PIM snooping is not configured on any interfaces/SAPs then all PIM packets will be discarded. If PIM or PIM snooping is configured on an interface/SAP, then multicast PIM messages are filter based on PIM being enabled on that particular interface. All unicast PIM messages are sent to the CPU to be processed.

The CPU protection features are supported on the following platforms:

- 7750 SR-7/SR-12
- 7450 ESS-6/ESS-7/ESS-12
- 7950 XRS

The CPU protection features are **not** supported on the following platforms:

- 7750 SR-1
- 7450 ESS-1
- 7710 SR-c4/c12
- 7750 SR-c4/c12

CPU Protection Extensions ETH-CFM

CPU protection has been extended to provide the ability to explicitly limit the amount of ETH-CFM traffic that arrives at the CPU for processing. ETH-CFM packets that are redirected to the CPU by either a Management Endpoint (MEP) or a Management Intermediate Point (MIP) will be subject to the configured limit of the associated policy. Up to four CPU protection policies may include up to ten individual eth-cfm specific entries. The eth-cfm entries allow the operator to apply a packet per second rate limit to the matching combination of level and opcode, for eth-cfm packet that are redirected to the CPU. Any eth-cfm traffic that is redirected to the CPU by a Management Point (MP) that does not match any entries of the applied policy is still subject to the overall rate limit of the policy itself. Any eth-cfm packets that are not redirected to the CPU are not subject to this function and are treated as transit data, subject to the applicable QoS policy.

The operator first creates a CPU Policy and includes the required eth-cfm entries. Overlap is allowed for the entries within a policy, first match logic is applied. This means ordering the entries in the proper sequence is important to ensure the proper behavior is achieved. Even though the number of eth-cfm entries is limited to ten, the entry numbers have a valid range from 1-100 to allow for ample space to insert policies between one and other.

Ranges are allowed when configuring the Level and the OpCode. Ranges provide the operator a simplified method for configuring multiple combinations. When more than one Level or OpCode is configured in this manner the configured rate limit is applied separately to each combination of level and OpCode match criteria. For example, if the Levels are configured with using a range of 5-7 and the OpCode is configured for 3,5 with a rate of 1. That restricts all possible combinations on that single entry to a rate of 1 packet per second. In this example six different match conditions are programmed behind the scene.

Table 4: Ranges versus Levels and OpCodes

Level	OpCode	Rate
5	3	1
5	5	1
6	3	1
6	5	1
7	3	1
7	5	1

Once the policy is created it must be applied to a SAP/Binding within a service for these rates to take affect. This means the rate is on a per SAP/Binding basis. Only a single policy may be applied to a SAP/Binding. The “eth-cfm-monitoring” option must be configured in order for the eth-cfm entries to be applied when the policy is applied to the SAP/Binding. If this option

is not configured, eth-cfm entries in the policy will be ignored. It is also possible to apply a policy to a SAP/Binding configuring “eth-cfm-monitoring” which does not have an MP. In this case, although these entries are enforced, no packets are being redirect to the CPU due to the lack of an MP.

By default, rates are applied on a per peer basis. This means each individual peer is subject to the rate. However, it is suggested that the “aggregate” option be configured to apply the rate to the sum total of all peers. MIPs for example only respond to Loopback Messages and Linktrace Messages. These are typically on demand functions and per peer rate limiting is likely not required thus making the aggregate function a more appealing model.

“eth-cfm-monitoring” and “mac-monitoring” are mutually exclusive and cannot be configured on the same SAP/Binding “mac-monitoring” is used in combination with the traditional CPU protection and is not specific to the eth-cfm rate limiting feature describe here.

When an MP is configured on a SAP/Binding within a service which allows an external source to communicate with that MP, for example a User to Network Interface (UNI), it is suggested that “eth-cfm-monitoring” with the “aggregate” option be configured on all SAP/ Bindings to provide the highest level of rate control.

The example below shows a sample configuration for a policy and the application of that policy to a SAP in a VPLS service configured with a MP.

Policy 1 entry 10 limits all eth-cfm traffic redirected to the CPU for all possible combinations to 1 packet per second. Policy 1 entry 20 limits all possible combinations to a rate of zero, dropping all request which match any combination. If entry 20 did not exist then only rate limiting of the entry 10 matches would occur and any other eth-cfm packets redirected to the CPU would not be bound by a CPU protection rate.

```
config>sys>security>cpu-protection#
  policy 1
    eth-cfm
      entry 10 level 5-7 opcode 3,5 rate 1
      entry 20 level 0-7 opcode 0-255 rate 0

config>service>vpls#
  sap 1/1/4:100
    cpu-protection 1 eth-cfm-monitoring aggregate
    eth-cfm
      mip
    no shutdown
```

IOM1s are restricted to Down MEPs and ingress MIP for this feature. This feature is not supported on UP MEPs and egress MIPs for this IOM type.

ETH-CFM Ingress Squelching

CPU protection provides a granular method to control which ETH-CFM packets are processed. As indicated in the previous section, a unique rate can be applied to ETH-CFM packets classifying on specific MD-Level and specific OpCode and applied to both ingress (Down MEP and ingress MIP) and egress (Up MEP and egress MIP) extraction. That function is to protect the CPU upon extraction when a Management Point (MP) is configured.

It is also important to protect the ETH-CFM architecture deployed in the service provider network. The protection scheme here varies from CPU protection. This model is used to prevent ETH-CFM frames at the service provider MD-levels from gaining access to the network even when extraction is not in place. ETH-CFM squelching allows the operator to achieve this goal using a simple method to drop all ETH-CFM packets at or below the configured MD-level. The ETH-CFM squelch feature is ingress only.

Figure 4 shows a typical ETH-CFM hierarchical model with a Subscriber ME (6), Test ME (5), EVC ME (4) and an Operator ME (2). This model provides the necessary transparency at the different levels of the architecture. For security reasons, it may be necessary to prevent errant levels from entering the service provider network at the UNI, ENNI, or other untrusted interconnection points. Configuring squelching at level four on both UNI-N interconnection ensures that ETH-CFM packets matching the SAP or binding delimited configuration will silently discard ETH-CFM packets at ingress.

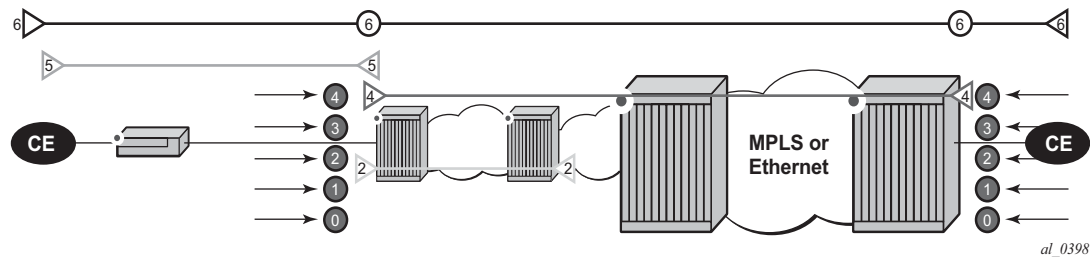

Figure 4: ETH-CFM Hierarchical Model

Squelching configuration uses a single MD-level [0..7] to silently drop all ETH-CFM packets matching the SAP or binding delimited configuration at and below the specified MD-level. In Figure 4, a squelch level is configured at MD-level 4. This means the configuration will silently discard MD-levels 0,1,2,3 and 4, assuming there is a SAP or binding match.

Note: Extreme caution must be used when deploying this feature.

The operator is able to configure Down MEPs and ingress MIPs that conflict with the squelched levels. This also means that any existing MEP or MIP processing ingress CFM packets on a SAP on Binding where a squelching policy is configured will be interrupted as

soon as this command is entered into the configuration. These MPs will not be able to receive any ingress ETH-CFM frames because squelching is processed before ETH-CFM extraction.

CPU Protection Extensions for ETH-CFM are still required in the model above because the Subscriber ME (6) and the Test ME (5) are entering the network across an untrusted connection, the UNI. ETH-CFM squelching and CPU Protection for ETH-CFM can be configured on the same SAP or binding. Squelching is first in the process order followed by CPU Protection for ETH-CFM.

MPs configured to support primary VLAN are not subjected to the squelch function. Primary VLAN based MPs, supported only on Ethernet SAPs, are extractions that take into consideration an additional VLAN beyond the SAP configuration.

The difference in the two protection mechanisms is shown in the [Table 5](#). CPU Protection is used to control access to the CPU resources when processing is required. Squelching is required when the operator is protecting the ETH-CFM architecture from external sources.

Table 5: CPU Protection and Squelching

Description	CPU Protection Extension for ETH-CFM	ETH-CFM Squelching
Ingress Filtering	Yes	Yes
Egress Filtering	Yes	No
Granularity	Specified Level AND OpCode	Level (At and below)
Rate	Configurable Rate (includes 0=drop all)	Silent Drop
Primary VLAN Support	Rate shared with SAP delineation	Not exposed to squelch
Extraction	Requires MEP or MIP to extract	No MEP or MIP required

As well as including the squelching information under the **show service *service-id* all**, display output the **squelch-ingress-level** key has been added to the **sap-using** and **sdp-using show** commands.

```
show service sap-using squelch-ingress-levels
=====
ETH-CFM Squelching
=====
PortId          SvcId          Squelch Level
-----
6/1/1:100.*    1              0 1 2 3 4 5 6 7
```

CPU Protection

```
lag-1:100.*      1      0 1 2 3 4
6/1/1:200.*     2      0 1 2
lag-1:200.*     2      0 1 2 3 4 5
-----
Number of SAPs: 4
-----
=====
show service sdp-using squelch-ingress-levels
=====
ETH-CFM Squelching
=====
SdpId           SvcId           Type Far End           Squelch Level
-----
12345:4000000000 2147483650     Spok 1.1.1.1           0 1 2 3 4
=====
```

Extreme caution must be used when deploying this feature.

Distributed CPU Protection (DCP)

SR OS provides several rate limiting mechanisms to protect the CPM/CFM processing resources of the router:

- CPU Protection: A centralized rate limiting function that operates on the CPM to limit traffic destined to the CPUs. This feature is described elsewhere in this guide.
- Distributed CPU Protection: A control traffic rate limiting protection mechanism for the CPM/CFM that operates on the line cards (hence ‘distributed’).

Distributed CPU Protection (DCP) offers a powerful per-protocol-per-object (examples of objects are SAPs and network interfaces) rate limiting function for control protocol traffic that is extracted from the data path and sent to the CPM. The DCP function is implemented on the router line cards that allows for high levels of scaling and granularity of control.

The DCP rate limiting is configured via policies that are applied to objects (for example, SAPs).

The basic types of policers in DCP are:

- Enforcement Policers — An instance of a policer that is policing a flow of packets comprised of a single (or small set of) protocols(s) arriving on a single object (for example, SAP). Enforcement policers perform a configurable action (for example, discard) on packets that exceed configured rate parameters. There are two basic sub-types of enforcement policers:
 - Static policers — always instantiate.
 - Dynamic policers — only instantiated (allocated from a free pool of dynamic policers) when a local monitor detects non-conformance for a set of protocols on a specific object.
- Local Monitors — A policer that is primarily used to measure the conformance of a flow comprised of multiple protocols arriving on a single object. Local monitors are used as a trigger to instantiate dynamic policers.

The use of dynamic policers reduces the number of policers required to effectively monitor and control a set of protocols across a large set of objects since the per-protocol-per-object dynamic policers are only instantiated when an attack or misconfiguration occurs, and they are only instantiated for the affected objects.

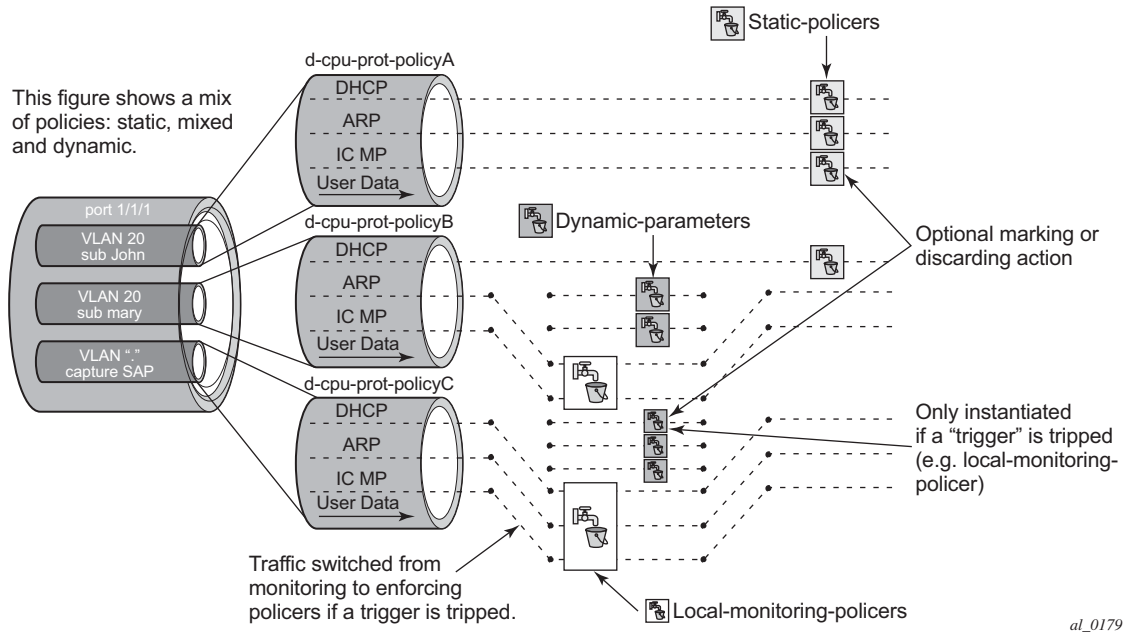

Figure 5: Per SAP per Protocol Static Rate Limiting with DCP

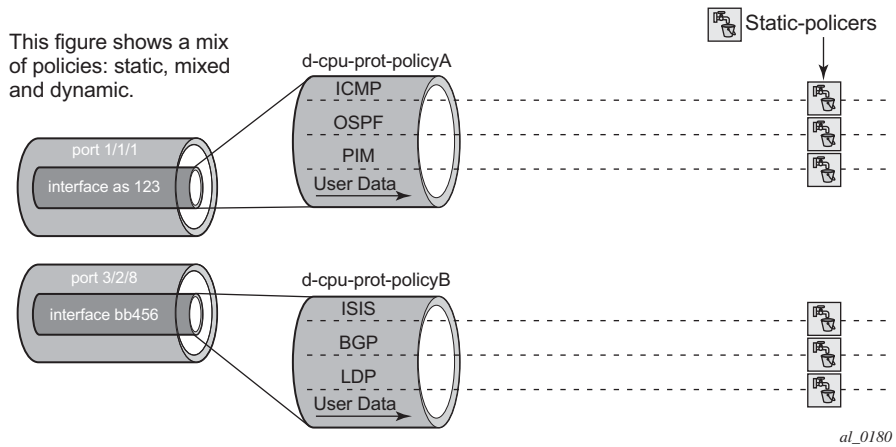

Figure 6: Per Network Interface per Protocol Static Rate Limiting with DCP

Applicability of Distributed CPU Protection

dist-cpu-protection (DCP) policies can be applicable to the following types of objects:

- most types of SAPs, including capture SAPs and SAPs on pseudo wires, but it is not applicable to b-vpls saps (b-saps).
- Network Interfaces, but not to any other type of interface. A DCP policy can be configured at the interface sap instead.

Control packets that are both forwarded (which means they could be subject to normal QoS policy policing) and also copied for extraction are not subject to Distributed CPU Protection (including in the all-unspecified bucket). This includes traffic snooping (for example, PIM in VPLS) as well as control traffic that is flooded in an R-VPLS instance and also extracted to the CPM such as ARP, ISIS and VRRP. Centralized per SAP/interface cpu-protection can be employed to rate limit or mark this traffic if desired.

Control traffic that arrives on a network interface, but inside a tunnel (for example, SDP, LSP, PW) and logically terminates on a service (that is, traffic that is logically extracted by the service rather than the network interface layer itself) will bypass the DCP function. The control packets in this case will not be subject to the DCP policy that is assigned to the network interface on which the packets arrived. This helps to avoid customer traffic in a service from impacting other services or the operator's infrastructure.

Control packets that are extracted in a vprn service, where the packets arrived into the node via a vpls SAP (that is, r-vpls scenario), will use the DCP policy and policer instances associated with the vpls SAP. In this case the DCP policy that an operator creates for use on VPLS SAPs, for VPLSs that have a l3-interface bound to them (r-vpls), may have protocols like OSPF, ARP, configured in the policy.

Log Events, Statistics, Status and SNMP support

A comprehensive set of log events are supported for DCP in order to alert the operator to potential attacks or misconfigurations and to allow tuning of the DCP settings. Refer to the NOTIFICATION-TYPE objects with “Dcp” in the names in the following MIBs for details:

- TIMETRA-CHASSIS-MIB
- TIMETRA-SAP-MIB
- TIMETRA-VRTR-MIB

The log events can also be seen in the CLI using the following **show log event-control | match Dcp** command

DCP throttles the rate of DCP events to avoid event floods when multiple parallel attacks or problems are occurring.

Many of the DCP log events can be individually enabled or disabled at the DCP policy level (in the DCP policy config) as well as globally in the system (in log event-control).

If needed when a DCP log event indicates a SAP, and that SAP is an MSAP, the operator can determine which subscriber(s) is/are on a specific MSAP by using the **show service active-subs** command and then filtering (“| match”) on the msap string.

Statistics and status related to DCP are available both via:

- CLI
- SNMP — See various tables and objects with “Dcp” or “DCpuProt” in their name in the TIMETRA-CHASSIS-MIB, TIMETRA-SECURITY-MIB, TIMETRA-SAP-MIB and TIMETRA-VRTR-MIB

DCP Policer Resource Management

The policer instances are a limited h/w resource on a given forwarding plane. DCP policers (static, dynamic, local-monitor) are consumed from the overall forwarding plane policer resources (from the ingress resources if ingress and egress are partitioned). Each per-protocol policer instantiated reduces the number of FP child policers available for other purposes.

When DCP is configured with dynamic enforcement, then the operator must set aside a pool of policers that can be instantiated as dynamic enforcement policers. The number of policers reserved for this function are configurable per card/fp. The policers in this pool are not available for other purposes (normal SLA enforcement).

Static enforcement policers and local monitoring policers use policers from the normal/global policer pool on the card/fp. Once a static policer is configured in a DCP policy and it is referenced by a protocol in the policy, then this policer will be instantiated for each object (SAP or network interface) that is created and references the policy. If there is no policer free on the associated card/fp, then the object will be blocked from being created. Similarly for local monitors: once a local monitoring policer is configured and referenced by a protocol, then this policer will be instantiated for each object that is created and references the policy. If there is no policer free, then the object will be blocked from being created.

Dynamic enforcement policers are allocated as needed (when the local monitor detects non-conformance) from the reserved dynamic-enforcement-policer-pool.

When a DCP policy is applied to an object on a LAG, then a set of policers is allocated on each forwarding plane (on each line card that contains a member of the LAG). The LAG mode is ignored and the policers are always shared by all ports in the LAG on that forwarding plane on the SAP/interface. In other words, with link-mode lag a set of DCP policers are not allocated per port in the LAG on the SAP.

In order to support large scale operation of DCP, and also to avoid overload conditions, a polling process is used to monitor state changes in the policers. This means there can be a delay between when an event occurs in the data plane and when the relevant state change or event notification occurs towards an operator, but in the meantime the policers are still operating and protecting the control plane.

Operational Guidelines and Tips

The following points offer various optional guidelines that may help an operator decide how to leverage Distributed CPU Protection.

- The rates in a policy assigned to a capture SAP should be higher than those assigned to MSAPs that will contain a single subscriber. The rates for the capture sap policy should allow for a burst of MSAP setups.
- To completely block a set of specific protocols on a given SAP, create a single static policer with a rate of 0 and map the protocols to that policer. Dynamic policers and local monitors can't be used to simultaneously allow some protocols but block others (the non-zero rates in the monitor would let all protocols slip through at a low rate).
- During normal operation it is recommended to configure "log-events" (no verbose keyword) for all static-policers, in the dynamic-parameters of all protocols and for all local-monitoring-policers. The verbose keyword can be used selectively during debug, testing, tuning and investigations.
- Packet based rate limiting is generally recommended for low rate subscriber based protocols whereas kbps rate limiting is recommended for higher rate infrastructure protocols (such as BGP).
- It is recommended to configure an exceed-action of low-priority for routing and infrastructure protocols. Marked packets are more likely to be discarded if there is congestion in the control plane of the router, but will get processed if there is no contention for CPU resources allowing for a work-conserving behavior in the CPM.
- In order to assign a different dist-cpu-protection policy to a specific MSAP (instance) or to all MSAPs for a specific msap policy, the operator can assign a new dist-cpu-protection policy to the MSAP policy and then use the **eval-msap** tool:

```
A:nodeA>tools>perform# subscriber-mgmt eval-msap  
- eval-msap { policy <msap-policy-name> | msap <sap-id> }
```

Note that any new MSAPs will also be assigned the new dist-cpu-protection policy.

- If needed, an operator can determine which subscriber is on a specific MSAP by using the **show service active-subs** command and then filtering ("| match") on the msap string.
- If protocol X is trusted, and using the "all-unspecified" protocol is not required, then simply avoid creating protocol X in the policy configuration.
- If protocol X is trusted, but the all-unspecified bucket is required, then there are two options:
 - avoid creating protocol X so that it is treated as part of the all-unspecified bucket (but account for the packets from X in the all-unspecified rate and local-mon rate),
or
 - create protocol X and configure it to bypass.

Vendor-Specific Attributes (VSAs)

The software supports the configuration of Alcatel-Lucent-specific RADIUS attributes. These attributes are known as vendor-specific attributes (VSAs) and are discussed in RFC 2138. VSAs must be configured when RADIUS authorization is enabled. It is up to the vendor to specify the format of their VSA. The attribute-specific field is dependent on the vendor's definition of that attribute. The Alcatel-Lucent-defined attributes are encapsulated in a RADIUS vendor-specific attribute with the vendor ID field set to 6527, the vendor ID number.

Note that the PE-record entry is required in order to support the RADIUS Discovery for Layer 2 VPN feature. Note that a PE-record is only relevant if the RADIUS Discovery feature is used, not for the standard RADIUS setup.

The following RADIUS vendor-specific attributes (VSAs) are supported by Alcatel-Lucent.

- `timetra-access <ftp> <console> <both>` — This is a mandatory command that must be configured. This command specifies if the user has FTP and /or console (serial port, Telnet, and SSH) access.
- `timetra-profile <profile-name>` — When configuring this VSA for a user, it is assumed that the user profiles are configured on the local router and the following applies for local and remote authentication:
 1. The `authentication-order` parameters configured on the router must include the `local` keyword.
 2. The user name may or may not be configured on the router.
 3. The user must be authenticated by the RADIUS server
 4. Up to 8 valid profiles can exist on the router for a user. The sequence in which the profiles are specified is relevant. The most explicit matching criteria must be ordered first. The process stops when the first complete match is found.

If all the above mentioned conditions are not met, then access to the router is denied and a failed login event/trap is written to the security log.

- `timetra-default-action <permit-all|deny-all|none>` — This is a mandatory command that must be configured even if the `timetra-cmd` VSA is not used. This command specifies the default action when the user has entered a command and no entry configured in the `timetra-cmd` VSA for the user resulted in a match condition.
- `timetra-cmd <match-string>` — Configures a command or command subtree as the scope for the match condition.

The command and all subordinate commands in subordinate command levels are specified.

Other Security Features

Secure Shell (SSH)

Secure Shell Version 1 (SSH) is a protocol that provides a secure, encrypted Telnet-like connection to a router. A connection is always initiated by the client (the user). Authentication takes place by one of the configured authentication methods (local, RADIUS, or TACACS+). With authentication and encryption, SSH allows for a secure connection over an insecure network.

The OS allows you to configure Secure Shell (SSH) Version 2 (SSH2). SSH1 and SSH2 are different protocols and encrypt at different parts of the packets. SSH1 uses server as well as host keys to authenticate systems whereas SSH2 only uses host keys. SSH2 does not use the same networking implementation that SSH1 does and is considered a more secure, efficient, and portable version of SSH.

SSH runs on top of a transport layer (like TCP or IP), and provides authentication and encryption capabilities.

The OS has a global SSH server process to support inbound SSH and SCP sessions initiated by external SSH or SCP client applications. The SSH server supports SSHv1. Note that this server process is separate from the SSH and SCP client commands on the routers which initiate outbound SSH and SCP sessions.

Inbound SSH sessions are counted as inbound telnet sessions for the purposes of the maximum number of inbound sessions specified by Login Control. Inbound SCP sessions are counted as inbound ftp sessions by Login Control.

When SSH server is enabled, an SSH security key is generated. The key is only valid until either the node is restarted or the SSH server is stopped and restarted (unless the preserve-key option is configured for SSH). The key size is non-configurable and set at 1024 bits. When the server is enabled, both inbound SSH and SCP sessions will be accepted provided the session is properly authenticated.

When the global SSH server process is disabled, no inbound SSH or SCP sessions will be accepted.

When using SCP to copy files from an external device to the file system, the SCP server will accept either forward slash (“/”) or backslash (“\”) characters to delimit directory and/or filenames. Similarly, the SCP client application can use either slash or backslash characters, but not all SCP clients treat backslash characters as equivalent to slash characters. In particular, UNIX systems will often times interpret the backslash character as an “escape” character which does not get transmitted to the SCP server. For example, a destination

directory specified as “cf1:\dir1\file1” will be transmitted to the SCP server as “cf1:dir1file1” where the backslash escape characters are stripped by the SCP client system before transmission. On systems where the client treats the backslash like an “escape” character, a double backslash “\\” or the forward slash “/” can typically be used to properly delimit directories and the filename.

Per Peer CPM Queuing

System-level security is crucial in service provider networks to address the increased threat of Denial-of-Service (DoS) attacks.

Control Processor Module Queuing (CPMQ) implements separate hardware-based queues which are allocated on a per-peer basis. CPMQ allocates a separate queue for each LDP and BGP peer and ensures that each queue is served in a round-robin fashion. This mechanism guarantees fair and “non-blocking” access to shared CPU resources across all peers. This would ensure, for example, that an LDP-based DoS attack from a given peer would be mitigated and compartmentalized so that not all CPU resources would be dedicated to the otherwise overwhelming control traffic sent by that specific peer.

CPMQ, using the “per-peer-queuing” command, ensures that service levels would not (or only partially be) impacted in case of an attack from a spoofed LDP or BGP peer IP address.

Per Peer CPM Queuing is supported on the 7750 SR-7/12 and 7750 SR-c12 platforms. It is not supported on the 7750 SR-1.-1.

CPM Filters and Traffic Management

Alcatel-Lucent routers have traffic management and queuing hardware dedicated to protecting the control plane.

CPM/CFM filters are supported on the following platforms: 7950 XRS, 7750 SR-7/SR-12/SR-c12, and 7710 SR-c4/SR-c12. The filters can be used to drop or accept packets, as well as allocate dedicated hardware shaping (CPM) queues for traffic directed to the control processors.

Users can allocate dedicated CPM hardware queues for certain traffic designated to the CPUs and can set the corresponding rate-limit for the queues. CPM queueing is supported on the following platforms: 7950 XRS, 7750 SR-7/SR-12, and 7750 SR-c12 (not 7750 SR-1).

CPM filters and queues control all traffic going in to the CPM from IOMs/XMAs, including all routing protocols. CPM filters apply to packets from all network and access ports, but not to packets from a management Ethernet port. CPM packet filtering and queuing is performed by network processor hardware using no resources on the main CPUs.

There are three filters that can be configured as part of the CPM filter policy: IP (v4) filter, IPv6 filter and MAC filter.

The SROS filter implementation exits the filter when the first match is found and execute the actions according to the specified action. For this reason, entries must be sequenced correctly from most to least explicit. When both mac-filter and ip-filter/ipv6-filter are to be applied to a given traffic, mac-filter is applied first.

An entry of an IP(v4), IPv6, MAC CPM filters must have at least one match criteria defined to be active. A default action can be specified for CPM filter policy that applies to each of IP, IPv6, MAC filters that are in a **no shutdown** state as long as the CPM filter policy has at least one active filter entry in any of the IP(v4), IPv6, and MAC filters.

TTL Security for BGP and LDP

The BGP TTL Security Hack (BTSH) was originally designed to protect the BGP infrastructure from CPU utilization-based attacks. It is derived on the fact that the vast majority of ISP eBGP peerings are established between adjacent routers. Since TTL spoofing cannot be performed, a mechanism based on an expected TTL value can provide a simple and reasonably robust defense from infrastructure attacks based on forged BGP packets.

While TSH is most effective in protecting directly connected peers, it can also provide a lower level of protection to multi-hop sessions. When a multi-hop BGP session is required, the expected TTL value can be set to 255 minus the configured range-of-hops. This approach can provide a qualitatively lower degree of security for BGP (for example, a DoS attack could, theoretically, be launched by compromising a box in the path). However, BTSH will catch a vast majority of observed distributed DoS (DDoS) attacks against eBGP. For further information, refer to draft-gill-btsh-xx.txt, *The BGP TTL Security Hack (BTSH)*.

TSH can be used to protect LDP peering sessions as well. For details, see draft-chen-ldp-ttl-xx.txt, *TTL-Based Security Option for LDP Hello Message*.

The TSH implementation supports the ability to configure TTL security per BGP/LDP peer and evaluate (in hardware) the incoming TTL value against the configured TTL value. If the incoming TTL value is less than the configured TTL value, the packets are discarded and a log is generated.

Exponential Login Backoff

A malicious user may attempt to gain CLI access by means of a dictionary attack using a script to automatically attempt to login as an “admin” user and using a dictionary list to test all possible passwords. Using the exponential-backoff feature in the **config>system>login-control** context the OS increases the delay between login attempts exponentially to mitigate attacks.

A malicious user may attempt to gain CLI access by means of a dictionary attack using a script to automatically attempt to login as an “admin” user and using a dictionary list to test all possible passwords. Using the exponential-backoff feature in the **config>system>login-control** context the OS increases the delay between login attempts exponentially to mitigate attacks.

When a user tries to login to a router using a Telnet or an SSH session, there are a limited number of attempts allowed to enter the correct password. The interval between the unsuccessful attempts change after each try (1, 2 and 4 seconds). If the system is configured for user lockout, then the user will be locked out when the number of attempts is exceeded.

However, if lockout is not configured, there are three password entry attempts allowed after the first failure, at fixed 1, 2 and 4 second intervals, in the first session, and then the session terminates. Users do not have an unlimited number of login attempts per session. After each failed password attempt, the wait period becomes longer until the maximum number of attempts is reached.

The OS terminates after four unsuccessful tries. A wait period will never be longer than 4 seconds. The periods are fixed and will restart in subsequent sessions.

Note that the **config>system>login-control>[no] exponential-backoff** command works in conjunction with the **config>system>security>password>attempts** command which is also a system wide configuration.

For example:

```
*A:ALA-48>config>system# security password attempts
- attempts <count> [time <minutes1>] [lockout <minutes2>]
- no attempts

<count>                : [1..64]
<minutes1>             : [0..60]
<minutes2>             : [0..1440]
```

Exponential backoff applies to any user and by any login method such as console, SSH and Telnet.

Refer to [Configuring Login Controls on page 92](#). The commands are described in [Login, Telnet, SSH and FTP Commands on page 119](#).

User Lockout

When a user exceeds the maximum number of attempts allowed (the default is 3 attempts) during a certain period of time (the default is 5 minutes) the account used during those attempts will be locked out for a pre-configured lock-out period (the default is 10 minutes).

An security event log will be generated as soon as a user account has exceeded the number of allowed attempts and the **show>system>security>user** command can be used to display the total number of failed attempts per user.

The account will be automatically re-enabled as soon as the lock-out period has expired. The list of users who are currently locked-out can be displayed with *show system security user lockout*.

A lock-out for a specific user can be administratively cleared using the *admin user x clear-lockout*.

Encryption

Data Encryption Standard (DES) and Triple DES (3DES) are supported for encryption.

- DES is a widely-used method of data encryption using a private (secret) key. Both the sender and the receiver must know and use the same private key.
- 3DES is a more secure version of the DES protocol.

802.1x Network Access Control

The Alcatel-Lucent OS supports network access control of client devices (PCs, STBs, etc.) on an Ethernet network using the IEEE. 802.1x standard. 802.1x is known as Extensible Authentication Protocol (EAP) over a LAN network or EAPOL.

TCP Enhanced Authentication Option

The TCP Enhanced Authentication Option, currently covered in draft-bonica-tcp-auth-05.txt, *Authentication for TCP-based Routing and Management Protocols*, extends the previous MD5 authentication option to include the ability to change keys without tearing down the session, and allows for stronger authentication algorithms to be used.

The TCP Enhanced Authentication Option is a TCP extension that enhances security for BGP, LDP and other TCP-based protocols. This includes the ability to change keys in a BGP or LDP session seamlessly without tearing down the session. It is intended for applications where secure administrative access to both the end-points of the TCP connection is normally available.

TCP peers can use this extension to authenticate messages passed between one another. This strategy improves upon current practice, which is described in RFC 2385, *Protection of BGP Sessions via the TCP MD5 Signature Option*. Using this new strategy, TCP peers can update authentication keys during the lifetime of a TCP connection. TCP peers can also use stronger authentication algorithms to authenticate routing messages.

Packet Formats

```

0                               1                               2                               3
0 1 2 3 4 5 6 7 8 9 0 1 2 3 4 5 6 7 8 9 0 1 2 3 4 5 6 7 8 9 0 1
+-----+-----+-----+-----+-----+-----+-----+-----+
| Kind      | Length  | T|K|   Alg ID|Res|           Key ID |
+-----+-----+-----+-----+-----+-----+-----+-----+
|                                     Authentication Data |
|                                     | // |
+-----+-----+-----+-----+-----+-----+-----+-----+

```

Option Syntax

- **Kind: 8 bits**
The Kind field identifies the TCP Enhanced Authentication Option. This value will be assigned by IANA.
- **Length: 8 bits**
The Length field specifies the length of the TCP Enhanced Authentication Option, in octets. This count includes two octets representing the Kind and Length fields.
The valid range for this field is from 4 to 40 octets, inclusive.
For all algorithms specified in this memo the value will be 16 octets.
- **T-Bit: 1 bit**
The T-bit specifies whether TCP Options were omitted from the TCP header for the purpose of MAC calculation. A value of 1 indicates that all TCP options other than the Extended Authentication Option were omitted. A value of 0 indicates that TCP options were included.
The default value is 0.
- **K-Bit: 1 bit**
This bit is reserved for future enhancement. Its value **MUST** be equal to zero.
- **Alg ID: 6 bits**
The Alg ID field identifies the MAC algorithm.

Other Security Features

- Res: 2 bits
These bits are reserved. They **MUST** be set to zero.
Key ID: 6 bits
The Key ID field identifies the key that was used to generate the message digest.
- Authentication Data: Variable length
- The Authentication Data field contains data that is used to authenticate the TCP segment. This data includes, but need not be restricted to, a MAC. The length and format of the Authentication Data Field can be derived from the Alg ID.
- The Authentication for TCP-based Routing and Management Protocols draft provides and overview of the TCP Enhanced Authentication Option. The details of this feature are described in draft-bonica-tcp-auth-04.txt.

Keychain

A keychain is a set of up to 64 keys, where each key is {A[i], K[i], V[i], S[i], T[i], S'[i], T'[i]} as described in draft-bonica-tcp-auth-05.txt, *Authentication for TCP-based Routing and Management Protocols*. They keys can be assigned to both sides of a BGP or LDP peer. The individual keys in a keychain have a begin- and end-time indicating when to use this key. These fields map to the CLI tree as:

Table 6: Keychain Mapping

Field	Definition	CLI
i	The key identifier expressed as an integer (0...63)	config>system>security>keychain>direction>bi>entry config>system>security>keychain>direction>uni>receive>entry config>system>security>keychain>direction>uni>send>entry
A[i]	Authentication algorithm to use with key[i]	config>system>security>keychain>direction>bi>entry with algorithm <i>algorithm</i> parameter. config>system>security>keychain>direction>uni>receive>entry with algorithm <i>algorithm</i> parameter. config>system>security>keychain>direction>uni>send>entry with algorithm <i>algorithm</i> parameter.
K[i]	Shared secret to use with key[i].	config>system>security>keychain>direction>uni>receive>entry with shared secret parameter config>system>security>keychain>direction>uni>send>entry with shared secret parameter config>system>security>keychain>direction>bi>entry with shared secret parameter
V[i]	A vector that determines whether the key[i] is to be used to generate MACs for inbound segments, outbound segments, or both.	config>system>security>keychain>direction
S[i]	Start time from which key[i] can be used by sending TCPs.	config>system>security>keychain>direction>bi>entry>begin-time config>system>security>keychain>direction>uni>send>entry >begin-time
T[i]	End time after which key[i] cannot be used by sending TCPs.	Inferred by the begin-time of the next key (youngest key rule).
S'[i]	Start time from which key[i] can be used by receiving TCPs.	config>system>security>keychain>direction>bi>entry>begin-time config>system>security>keychain>direction>bi>entry>tolerance config>system>security>keychain>direction>uni>receive>entry >begin-time config>system>security>keychain>direction>uni>receive>entry >tolerance
T'[i]	End time after which key[i] cannot be used by receiving TCPs	config>system>security>keychain>direction>uni>receive>entry>end-time

Configuration Notes

This section describes security configuration caveats.

General

- If a RADIUS or a TACACS+ server is not configured, then password, profiles, and user access information must be configured on each router in the domain.
- If a RADIUS authorization is enabled, then VSAs must be configured on the RADIUS server.

Configuring Security with CLI

This section provides information to configure security using the command line interface.

Topics in this section include:

- [Setting Up Security Attributes on page 62](#)
 - [Configuring Authorization on page 63](#)
 - [Configuring Authorization on page 63](#)
 - [Configuring Accounting on page 65](#)
- [Configuration Tasks on page 67](#)
- [Security Configuration Procedures on page 68](#)
 - [Configuring Management Access Filters on page 68](#)
 - [Configuring CPM Filters Policy on page 70](#)
 - [Configuring IPv6 CPM Filters on page 72](#)
 - [Configuring CPM Queues on page 73](#)
 - [Configuring Password Management Parameters on page 74](#)
 - [Configuring Profiles on page 76](#)
 - [Configuring Users on page 77](#)
 - [Copying and Overwriting Users and Profiles on page 79](#)
 - [Enabling SSH on page 91](#)
 - [Configuring Login Controls on page 92](#)
 - [RADIUS Configurations on page 83](#)
 - [Configuring RADIUS Authentication on page 83](#)
 - [Configuring RADIUS Authorization on page 84](#)
 - [Configuring RADIUS Accounting on page 85](#)
 - [TACACS+ Configurations on page 88](#)
 - [Enabling TACACS+ Authentication on page 88](#)
 - [Configuring TACACS+ Authorization on page 89](#)
 - [Configuring TACACS+ Accounting on page 90](#)
 - [Configuring Login Controls on page 92](#)

Setting Up Security Attributes

Configuring Authentication

Refer to the following sections to configure authentication:

- Local authentication
 - [Configuring Password Management Parameters on page 74](#)
 - [Configuring Profiles on page 76](#)
 - [Configuring Users on page 77](#)
- RADIUS authentication (only)

By default, authentication is enabled locally. Perform the following tasks to configure security on each participating router:

 - [Configuring Profiles on page 76](#)
 - [Configuring RADIUS Authentication on page 83](#)
 - [Configuring Users on page 77](#)
- RADIUS authentication
To implement only RADIUS authentication, *with* authorization, perform the following tasks on each participating router:
 - [Configuring RADIUS Authentication on page 83](#)
 - [Configuring RADIUS Authorization on page 84](#)
- TACACS+ authentication
To implement only TACACS+ authentication, perform the following tasks on each participating router:
 - [Configuring Profiles on page 76](#)
 - [Configuring Users on page 77](#)
 - [Enabling TACACS+ Authentication on page 88](#)

Configuring Authorization

Refer to the following sections to configure authorization.

- Local authorization
For local authorization, configure these tasks on each participating router:
 - [Configuring Profiles on page 76](#)
 - [Configuring Users on page 77](#)

- RADIUS authorization (only)
For RADIUS authorization (without authentication), configure these tasks on each participating router:
 - [Configuring RADIUS Authorization on page 84](#)
 - [Configuring Profiles on page 76](#)For RADIUS authorization, VSAs must be configured on the RADIUS server. See [Vendor-Specific Attributes \(VSAs\) on page 49](#).

- RADIUS authorization
For RADIUS authorization (with authentication), configure these tasks on each participating router:
 - [Configuring RADIUS Authorization on page 84](#)
 - For RADIUS authorization, VSAs must be configured on the RADIUS server. See [Vendor-Specific Attributes \(VSAs\) on page 49](#).
 - [Configuring RADIUS Authentication on page 83](#)
 - [Configuring Profiles on page 76](#)

- TACACS+ authorization (only)
For TACACS+ authorization (without authentication), configure these tasks on each participating router:
 - [Configuring TACACS+ Authorization on page 89](#)

Setting Up Security Attributes

- TACACS+ authorization

For TACACS+ authorization (with authentication), configure these tasks on each participating router:

→ [Enabling TACACS+ Authentication on page 88](#)

→ [Configuring TACACS+ Authorization on page 89](#)

Configuring Accounting

Refer to the following sections to configure accounting.

- Local accounting is not implemented. For information about configuring accounting policies, refer to [Configuring Logging with CLI on page 373](#)
- [Configuring RADIUS Accounting on page 85](#)
- [Configuring TACACS+ Accounting on page 90](#)

Security Configurations

This section provides information to configure security and configuration examples of configuration tasks.

To implement security features, configure the following components:

- Management access filters and CPM filters
- Profiles
- User access parameters
- Password management parameters
- Enable RADIUS and/or TACACS+
 - One to five RADIUS and/or TACACS+ servers
 - RADIUS and/or TACACS+ parameters

Configuration Tasks

This section provides a brief overview of the tasks that must be performed to configure security and provides the CLI commands. [Table 7](#) depicts the capabilities of authentication, authorization, and accounting configurations. For example, authentication can be enabled locally and on RADIUS and TACACS+ servers. Authorization can be executed locally, on a RADIUS server, or on a TACACS+ server. Accounting can be performed on a RADIUS or TACACS+ server.

Table 7: Security Configuration Requirements

Authentication	Authorization	Accounting
Local	Local	None
RADIUS	Local and RADIUS	RADIUS
TACACS+	Local	TACACS+

Security Configuration Procedures

- [Configuring Management Access Filters on page 68](#)
- [Configuring CPM Filters Policy on page 70](#)
- [Configuring CPM Queues on page 73](#)
- [Configuring Profiles on page 76](#)
- [Configuring Users on page 77](#)
- [Copying and Overwriting Users and Profiles on page 79](#)
- [Enabling SSH on page 91](#)

Configuring Management Access Filters

Creating and implementing management access filters is optional. Management access filters are software-based filters that control all traffic going in to the CPM, including all routing protocols. They apply to packets from all ports. The filters can be used to restrict management of the router by other nodes outside either specific (sub)networks or through designated ports. By default, there are no filters associated with security options. The management access filter and entries must be explicitly created on each router. These filters also apply to the management Ethernet port.

The OS implementation exits the filter when the first match is found and execute the actions according to the specified action. For this reason, entries must be sequenced correctly from most to least explicit. When both **mac-filter** and **ip-filter/ipv6-filter** are to be applied to a given traffic, **mac-filter** is applied first.

An entry may not have any match criteria defined (in which case, everything matches) but must have at least an action keyword specified to be considered active. Entries without the action keyword are considered incomplete and will be rendered inactive. Management Access Filter must have at least one active entry defined for the filter to be active.

The following is an example of a management access filter configuration that accepts packets matching the criteria specified in IP, IPv6 and MAC entries. Non-matching packets are denied for IPv4 filter and permitted for IPv6 and MAC filters.

```
*A:Dut-C>config>system>security>mgmt-access-filter# info
-----
      ip-filter
      default-action deny
      entry 10
          description "Accept SSH from mgmnt subnet"
          src-ip 192.168.5.0/26
          protocol tcp
          dst-port 22 65535
          action permit
```

```
        exit
    exit
    ipv6-filter
        default-action permit
        entry 10
            src-ip 3FFE::1:1/128
            next-header rsvp
            log
            action deny
        exit
    exit
    mac-filter
        default-action permit
        entry 12
            match frame-type ethernet_II
            svc-id 1
            src-mac 00:01:01:01:01:01 ff:ff:ff:ff:ff:ff
        exit
        action permit
    exit
    exit
    exit
-----
*A:Dut-C>config>system>security>mgmt-access-filter#
```

Configuring CPM Filters Policy

The following displays an CPM filter configuration example:

```
*A:Dut-C>config>sys>security>cpm-filter# info
ip-filter
    shutdown
    entry 100 create
        action queue 50
        log 110
        match protocol icmp
            fragment true
            icmp-type dest-unreachable
            icmp-code host-unreachable
            multiple-option false
            option-present true
            src-ip 192.100.2.0/24
    exit
exit
exit
ipv6-filter
    shutdown
    entry 30 create
        action drop
        log 190
        match next-header tcp
            dscp ef
            dst-ip 3FFE::2:2/128
            src-port 100 100
            tcp-syn true
            tcp-ack false
            flow-label 10
    exit
exit
exit
mac-filter
    shutdown
    entry 40 create
        action accept
        log 101
        match frame-type ethernet_II
            svc-id 12
            dst-mac 00:03:03:03:01:01 ff:ff:ff:ff:ff:ff
            etype 0x8902
            cfm-opcode gt 100
    exit
exit
exit
*A:Dut-C>config>sys>security>cpm-filter#
```

The following displays a MAC CPM filter configuration example:

```
*A:ALA-49>config>sys>sec>cpm>mac-filter# info
-----
    entry 10 create
```

```
        description "MAC-CPM-Filter 10.10.10.100 #007"  
        match  
        exit  
        log 101  
        action drop  
    exit  
    entry 20 create  
        description "MAC-CPM-Filter 10.10.10.100 #008"  
        match  
        exit  
        log 101  
        action drop  
    exit  
    no shutdown  
-----  
*A:ALA-49>config>sys>sec>cpm>mac-filter#
```

Configuring IPv6 CPM Filters

The following example displays an IPv6 CPM filter configuration:

```
A:ALA-48>config>sys>sec>cpm>ipv6-filter# info
entry 10 create
  description "IPv6 CPM Filter"
  log 101
  match next-header igp
    dst-ip 1000:1:1:1:1:1:1:1/112
    src-ip 2000:1::1/96
    flow-label 5000
  exit
exit
entry 20 create
  description "CPM-Filter 10.4.101.2 #201"
  log 101
  match next-header tcp
    dscp af11
    dst-ip 3FEE:12E1:2AC1:EA32::/64
    src-ip 3FEE:1FE1:2AC1:EA32::/64
    flow-label 5050
  exit
exit
no shutdown
A:ALA-48>config>sys>sec>cpm>ipv6-filter#
```

Configuring CPM Queues

CPM queues can be used to provide rate limit capabilities for traffic destined to CPM as described in an earlier section of this document.

The following example displays a CPM queue configuration:

```
A:ALA-987>config>sys>security>cpm-queue# info
-----
      queue 33 create
      exit
      queue 101 create
      cbs 5
      mbs 5
      rate 5 cir 5
      exit
      queue 102 create
      cbs 5
      mbs 5
      rate 5 cir 5
      exit
      queue 103 create
      cbs 5
      mbs 5
      rate 5 cir 5
      exit
      queue 104 create
      cbs 5
      mbs 5
      rate 5 cir 5
-----
A:ALA-987>config>sys>security>cpm-queue#
```

IPSec Certificates Parameters

The following is an example to importing a certificate from a pem format:

```
*A:SR-7/Dut-A# admin certificate import type cert input cf3:/pre-import/R1-0cert.pem out-  
put R1-0cert.der format pem
```

The following is an example for exporting a certificate to pem format:

```
*A:SR-7/Dut-A# admin certificate export type cert input R1-0cert.der output cf3:/R1-  
0cert.pem format pem
```

The following displays an example of profile output:

```
*A:SR-7/Dut-A>config>system>security>pki# info  
-----  
ca-profile "Root" create  
description "Root CA"  
cert-file "R1-0cert.der"  
crl-file "R1-0crl.der"  
no shutdown  
exit  
-----  
*A:SR-7/Dut-A>config>system>security>pki#
```

The following displays an example of an ike-policy with cert-auth output:

```
:SR-7/Dut-A>config>ipsec>ike-policy# info  
-----  
ike-version 2  
auth-method cert-auth  
own-auth-method psk  
-----
```

The following displays an example of a static lan-to-lan configuration using cert-auth:

```
interface "VPRN1" tunnel create
```

```
    sap tunnel-1.private:1 create
        ipsec-tunnel "Sanity-1" create
            security-policy 1
            local-gateway-address 30.1.1.13 peer 50.1.1.15 delivery-service 300
            dynamic-keying
                ike-policy 1
                pre-shared-key "Sanity-1"
                transform 1
                cert
                    trust-anchor "R1-0"
                    cert "M2cert.der"
                    key "M2key.der"
                exit
            exit
        exit
    no shutdown
exit
exit
exit
```

Configuring Profiles

Profiles are used to deny or permit access to a hierarchical branch or specific commands. Profiles are referenced in a user configuration. A maximum of sixteen user profiles can be defined. A user can participate in up to sixteen profiles. Depending on the the authorization requirements, passwords are configured locally or on the RADIUS server.

The following example displays a user profile output:

```
A:ALA-1>config>system>security# info
-----
...
    profile "ghost"
        default-action permit-all
        entry 1
            match "configure"
            action permit
        exit
        entry 2
            match "show"
        exit
        entry 3
            match "exit"
        exit
    exit
...
-----
A:ALA-1>config>system>security#
```

Configuring Users

Configure access parameters for individual users. For user, define the login name for the user and, optionally, information that identifies the user. The following displays a user configuration example:

```
A:ALA-1>config>system>security# info
-----
...
    user "49ers"
      password "qQbnuzLd7H/VxGdUqdh7bE" hash2
      access console ftp snmp
      restricted-to-home
      console
        member "default"
        member "ghost"
      exit
    exit
...
-----
A:ALA-1>config>system>security#
```

Configuring Keychains

The following displays a keychain configuration.

```
A:ALA-1>config>system>security# info
-----
...
    keychain "abc"
        direction
            bi
                entry 1 key "ZcvSELJzJx/wBZ9biCtOVQJ9YZQvVU.S" hash2 alg
algorithm aes-128-cmac-96
                begin-time 2006/12/18 22:55:20
                exit
            exit
        exit
    exit
    keychain "basasd"
        direction
            uni
                receive
                    entry 1 key "Ee7xdK1YO2D0m7v3IJv/84LIu96R2fZh" hash2
algorithm aes-128-cmac-96
                    tolerance forever
                exit
            exit
        exit
    exit
    exit
...
-----
A:ALA-1>config>system>security#
```

Copying and Overwriting Users and Profiles

You can copy a profile or user. You can copy a profile or user or overwrite an existing profile or user. The **overwrite** option must be specified or an error occurs if the destination profile or user name already exists.

User

CLI Syntax: `config>system>security# copy {user source-user | profile source-profile} to destination [overwrite]`

Example:

```
config>system>security# copy user testuser to testuserA
MINOR: CLI User "testuserA" already exists - use overwrite
flag.

config>system>security#
config>system>security# copy user testuser to testuserA
overwrite
config>system>security#
```

The following output displays the copied user configurations:

```
A:ALA-12>config>system>security# info
-----
...
    user "testuser"
        password "F6XjryaATzM" hash
        access snmp
        snmp
            authentication hash md5 e14672e71d3e96e7a1e19472527ee969 privacy none
            group "testgroup"
        exit
    exit
    user "testuserA"
        password "" hash2
        access snmp
        console
            new-password-at-login
        exit
        snmp
            authentication hash md5 e14672e71d3e96e7a1e19472527ee969 privacy none
            group "testgroup"
        exit
    exit
...
-----
A:ALA-12>config>system>security# info
```

Security Configuration Procedures

Note that the cannot-change-password flag is not replicated when a copy user command is performed. A new-password-at-login flag is created instead.

```
A:ALA-12>config>system>security>user# info
-----
password "F6XjryaATzM" hash
access snmp
console
cannot-change-password
exit
snmp
authentication hash md5 e14672e71d3e96e7a1e19472527ee969 privacy none
group "testgroup"
exit
-----
A:ALA-12>config>system>security>user# exit
A:ALA-12>config>system>security# user testuserA
A:ALA-12>config>system>security>user# info
-----
password "" hash2
access snmp
console
new-password-at-login
exit
snmp
authentication hash md5 e14672e71d3e96e7a1e19472527ee969 privacy none
group "testgroup"
exit
-----
A:ALA-12>config>system>security>user#
```

Profile

CLI Syntax: `config>system>security# copy {user source-user | profile source-profile} to destination [overwrite]`

Example: `config>system>security# copy profile default to testuser`

The following output displays the copied profiles:

```
A:ALA-49>config>system>security# info
-----
...
A:ALA-49>config>system>security# info detail
-----
...
        profile "default"
            default-action none
            entry 10
                no description
                match "exec"
                action permit
            exit
            entry 20
                no description
                match "exit"
                action permit
            exit
            entry 30
                no description
                match "help"
                action permit
            exit
            entry 40
                no description
                match "logout"
                action permit
            exit
            entry 50
                no description
                match "password"
                action permit
            exit
            entry 60
                no description
                match "show config"
                action deny
            exit
            entry 70
                no description
                match "show"
                action permit
            exit
            entry 80
                no description
                match "enable-admin"
```

Security Configuration Procedures

```
        action permit
    exit
exit
profile "testuser"
    default-action none
    entry 10
        no description
        match "exec"
        action permit
    exit
    entry 20
        no description
        match "exit"
        action permit
    exit
    entry 30
        no description
        match "help"
        action permit
    exit
    entry 40
        no description
        match "logout"
        action permit
    exit
    entry 50
        no description
        match "password"
        action permit
    exit
    entry 60
        no description
        match "show config"
        action deny
    exit
    entry 70
        no description
        match "show"
        action permit
    exit
    entry 80
        no description
        match "enable-admin"
        action permit
    exit
exit
profile "administrative"
    default-action permit-all exit
...
-----
A:ALA-12>config>system>security#
```

RADIUS Configurations

- [Configuring RADIUS Authentication on page 83](#)
- [Configuring RADIUS Authorization on page 84](#)
- [Configuring RADIUS Accounting on page 85](#)
- [Configuring 802.1x RADIUS Policies on page 86](#)

Configuring RADIUS Authentication

RADIUS is disabled by default and must be explicitly enabled. The mandatory commands to enable RADIUS on the local router are **radius** and `server server-index address ip-address secret key`.

Also, the system IP address must be configured in order for the RADIUS client to work. See [Configuring a System Interface of the 7750 SR OS Router Configuration Guide](#).

The other commands are optional. The `server` command adds a RADIUS server and configures the RADIUS server's IP address, index, and key values. The index determines the sequence in which the servers are queried for authentication requests.

On the local router, use the following CLI commands to configure RADIUS authentication:

```
CLI Syntax: config>system>security
                radius
                port port
                retry count
                server server-index address ip-address secret key
                timeout seconds
                no shutdown
```

The following displays a RADIUS authentication configuration example:

```
A:ALA-1>config>system>security# info
-----
                retry 5
                timeout 5
                server 1 address 10.10.10.103 secret "test1"
                server 2 address 10.10.0.1 secret "test2"
                server 3 address 10.10.0.2 secret "test3"
                server 4 address 10.10.0.3 secret "test4"
                ...
-----
A:ALA-1>config>system>security#
```

Configuring RADIUS Authorization

In order for RADIUS authorization to function, RADIUS authentication *must* be enabled first. See [Configuring RADIUS Authentication on page 83](#).

In addition to the local configuration requirements, VSAs must be configured on the RADIUS server. See [Vendor-Specific Attributes \(VSAs\) on page 49](#).

On the local router, use the following CLI commands to configure RADIUS authorization:

```
CLI Syntax: config>system>security
                radius
                authorization
```

The following displays a RADIUS authorization configuration example:

```
A:ALA-1>config>system>security# info
-----
...
    radius
        authorization
        retry 5
        timeout 5
        server 1 address 10.10.10.103 secret "test1"
        server 2 address 10.10.0.1 secret "test2"
        server 3 address 10.10.0.2 secret "test3"
        server 4 address 10.10.0.3 secret "test4"
    exit
...
-----
A:ALA-1>config>system>security#
```

Configuring RADIUS Accounting

On the local router, use the following CLI commands to configure RADIUS accounting:

```
CLI Syntax: config>system>security
                radius
                accounting
```

The following displays RADIUS accounting configuration example:

```
A:ALA-1>config>system>security# info
-----
...
    radius
    shutdown
    authorization
    accounting
    retry 5
    timeout 5
    server 1 address 10.10.10.103 secret "test1"
    server 2 address 10.10.0.1 secret "test2"
    server 3 address 10.10.0.2 secret "test3"
    server 4 address 10.10.0.3 secret "test4"
    exit
...
-----
A:ALA-1>config>system>security#
```

Configuring 802.1x RADIUS Policies

Use the following CLI commands to configure generic authentication parameters for clients using 802.1x EAPOL. Additional parameters are configured per Ethernet port. Refer to the 7750 SR OS Interface Configuration Guide

To configure generic parameters for 802.1x authentication, enter the following CLI syntax.

CLI Syntax:

```
config>system>security
  dot1x
    radius-plcy policy-name
      server server-index address ip-address secret key [port]
      source-address ip-address
      no shutdown
```

The following displays a 802.1x configuration example:

```
A:ALA-1>config>system>security# info
-----
      dot1x
        radius-plcy "dot1x_plcy" create
          server 1 address 1.1.1.1 port 65535 secret "a"
          server 2 address 1.1.1.2 port 6555 secret "a"
          source-address 1.1.1.255
          no shutdown
      ...
-----
A:ALA-1>config>system#
```

Configuring CPU Protection Policies

The CPU protection features are supported on the 7750 SR-7/12 platforms. These features are not available on the 7750 SR-1 or 7750 SR-c12.

For more information about CPU protection, see “CPU Protection” and “Monitoring Attacks on the 7750 SR” sections in *SR OS Security Best Practices*.

TACACS+ Configurations

- [Enabling TACACS+ Authentication on page 88](#)
 - [Configuring TACACS+ Authorization on page 89](#)
 - [Configuring TACACS+ Accounting on page 90](#)
-

Enabling TACACS+ Authentication

To use TACACS+ authentication on the router, configure one or more TACACS+ servers on the network.

Use the following CLI commands to configure profiles:

CLI Syntax: `config>system>security
tacplus
server server-index address ip-address secret key
timeout seconds
no shutdown`

The following displays a TACACS+ authentication configuration example:

```
A:ALA-1>config>system>security>tacplus# info
-----
      timeout 5
      server 1 address 10.10.0.5 secret "test1"
      server 2 address 10.10.0.6 secret "test2"
      server 3 address 10.10.0.7 secret "test3"
      server 4 address 10.10.0.8 secret "test4"
      server 5 address 10.10.0.9 secret "test5"
-----
A:ALA-1>config>system>security>tacplus#
```

Configuring TACACS+ Authorization

In order for TACACS+ authorization to function, TACACS+ authentication *must* be enabled first. See [Enabling TACACS+ Authentication on page 88](#).

On the local router, use the following CLI commands to configure RADIUS authorization:

```
CLI Syntax: config>system>security
               tacplus
                 authorization
                 no shutdown
```

The following displays a TACACS+ authorization configuration example:

```
A:ALA-1>config>system>security>tacplus# info
-----
      authorization
      timeout 5
      server 1 address 10.10.0.5 secret "test1"
      server 2 address 10.10.0.6 secret "test2"
      server 3 address 10.10.0.7 secret "test3"
      server 4 address 10.10.0.8 secret "test4"
      server 5 address 10.10.0.9 secret "test5"
-----
A:ALA-1>config>system>security>tacplus#
```

Configuring TACACS+ Accounting

On the local router, use the following CLI commands to configure TACACS+ accounting:

```
CLI Syntax: config>system>security
               tacplus
               accounting
```

The following displays a TACACS+ accounting configuration example:

```
A:ALA-1>config>system>security>tacplus# info
-----
      accounting
      authorization
      timeout 5
      server 1 address 10.10.0.5 secret "test1"
      server 2 address 10.10.0.6 secret "test2"
      server 3 address 10.10.0.7 secret "test3"
      server 4 address 10.10.0.8 secret "test4"
      server 5 address 10.10.0.9 secret "test5"
-----
A:ALA-1>config>system>security>tacplus#
```

Enabling SSH

Use the SSH command to configure the SSH server as SSH1, SSH2 or both. The default is SSH2 (SSH version 2). This command should only be enabled or disabled when the SSH server is disabled. This setting should not be changed while the SSH server is running since the actual change only takes place after SSH is disabled or enabled.

CLI Syntax: `config>system>security
ssh
preserve-key
no server-shutdown
version ssh-version`

The following displays a SSH server configuration as both SSH and SSH2 using a host-key:

```
A:sim1>config>system>security>ssh# info
-----
                preserve-key
                version 1-2
-----
A:sim1>config>system>security>ssh#
```

Configuring Login Controls

Configure login control parameters for console, Telnet, and FTP sessions.

To configure login controls, enter the following CLI syntax.

```
CLI Syntax: config>system
                login-control
                  exponential-backoff
                  ftp
                    inbound-max-sessions value
                  telnet
                    inbound-max-sessions value
                    outbound-max-sessions value
                    idle-timeout {minutes |disable}
                    pre-login-message login-text-string [name]
                    login-banner
                    motd {url url-prefix: source-url |text motd-text-string}
```

The following displays a login control configuration example:

```
A:ALA-1>config>system# info
-----
...
    login-control
      ftp
        inbound-max-sessions 5
      exit
      telnet
        inbound-max-sessions 7
        outbound-max-sessions 2
      exit
      idle-timeout 1440
      pre-login-message "Property of Service Routing Inc. Unauthorized access prohib-
ited."
      motd text "Notice to all users: Software upgrade scheduled 3/2 1:00 AM"
      exit
    no exponential-backoff
...
-----
A:ALA-1>config>system#
```

Security Command Reference

Command Hierarchies

Configuration Commands

- [Security Commands](#)
 - [LLDP Commands on page 94](#)
 - [Management Access Filter Commands on page 95](#)
 - [CPM Filter Commands on page 96](#)
 - [CPM Queue Commands on page 99](#)
 - [CPU Protection Commands on page 100](#)
 - [Distributed CPU Protection Commands on page 101](#)
 - [Security Password Commands on page 102](#)
 - [Public Key Infrastructure \(PKI\) Commands on page 103](#)
 - [Profile Commands on page 103](#)
 - [RADIUS Commands on page 104](#)
 - [SSH Commands on page 104](#)
 - [TACPLUS Commands on page 104](#)
 - [User Template Commands on page 105](#)
 - [Dot1x Commands on page 105](#)
 - [Keychain Commands on page 106](#)
- [Login Control Commands on page 107](#)
- [Show Commands on page 108](#)
- [Clear Commands on page 109](#)
- [Debug Commands on page 109](#)
- [Tools Commands on page 109](#)

Security Commands

```
config
  — system
    — security
      — copy {user source-user | profile source-profile} to destination [overwrite]
      — [no] ftp-server
      — hash-control [read-version {1 | 2 | all}] [write-version {1 | 2}]
      — no hash-control
      — [no] per-peer-queuing
      — source-address
        — application app [ip-int-name | ip-address]
        — no application app
        — application6 app ipv6-address
        — no application6
      — [no] telnet-server
      — [no] telnet6-server
      — vprn-network-exceptions number seconds
```

LLDP Commands

```
configure
  — system
    — lldp
      — message-fast-tx time
      — no message-fast-tx
      — message-fast-tx-init count
      — no message-fast-tx-init
      — notification-interval time
      — no notification-interval
      — reinit-delay time
      — no reinit-delay
      — tx-credit-max count
      — no tx-credit-max
      — tx-hold-multiplier multiplier
      — no tx-hold-multiplier
      — tx-interval interval
      — no tx-interval
```

Management Access Filter Commands

```

config
  — system
    — security
      — [no] management-access-filter
        — [no] ip-filter
          — default-action {permit | deny}
          — [no] entry entry-id
            — action {permit | deny | deny-host-unreachable}
            — no action
            — description description-string
            — no description
            — dst-port value [mask]
            — no dst-port
            — [no] log
            — protocol protocol-id
            — no protocol
            — router {router-instance}
            — no router
            — src-ip {ip-prefix/mask | ip-prefix netmask}
            — no src-ip
            — src-port {port-id | cpm | lag lag-id }
            — no src-port
            — src-port old-entry-number new-entry-number
          — rename old-entry-number new-entry-number
          — [no] shutdown
        — [no] ipv6-filter
          — default-action {permit | deny | deny-host-unreachable}
          — [no] entry entry-id
            — action {permit | deny | deny-host-unreachable}
            — no action
            — description description-string
            — no description
            — dst-port value [mask]
            — no dst-port
            — flow-label value
            — no flow-label
            — [no] log
            — next-header next-header
            — no next-header
            — router {router-instance}
            — no router
            — src-ip {ip-prefix/mask | ip-prefix netmask}
            — no src-ip
            — src-port {port-id | cpm | lag lag-id }
            — no src-port
          — rename old-entry-number new-entry-number
          — [no] shutdown
        — [no] mac-filter
          — default-action {permit | deny}
          — [no] entry entry-id
            — action {permit | deny | deny-host-unreachable}
            — no action

```

- **description** *description-string*
- **no description**
- **[no] log**
- **match frame-type** *frame-type*
- **no match**
 - **cfm-opcode** {**lt** | **gt** | **eq**} *opcode*
 - **cfm-opcode range** *start end*
 - **no cfm-opcode**
 - **dot1p** *dot1p-value* [*dot1p-mask*]
 - **dsap** *dsap-value* [*dsap-mask*]
 - **dst-mac** *ieee-address* [*ieee-address-mask*]
 - **no dst-mac**
 - **etype** *0x0600..0xffff*
 - **no etype**
 - **snap-oui** {**zero** | **non-zero**}
 - **snap-pid** *snap-pid*
 - **no snap-pid**
 - **src-mac** *ieee-address* [*ieee-address-mask*]
 - **no src-mac**
 - **ssap** *ssap-value* [*ssap-mask*]
 - **no ssap**
 - **svc-id** *service-id*
 - **no svc-id**
- **renum** *old-entry-number new-entry-number*
- **[no] shutdown**

CPM Filter Commands

- config**
 - **system**
 - **security**
 - **[no] cpm-filter**
 - **default-action** {**accept** | **drop**}
 - **[no] ip-filter**
 - **[no] entry** *entry-id*
 - **action** [**accept** | **drop** | **queue** *queue-id*]
 - **no action**
 - **description** *description-string*
 - **no description**
 - **log** *log-id*
 - **no log**
 - **match** [**protocol** *protocol-id*]
 - **no match**
 - **dscp** *dscp-name*
 - **no dscp**
 - **dst-ip** {*ip-address/mask* | *ip-address netmask* | **ip-prefix-list** *prefix-list-name*}
 - **no dst-ip**
 - **dst-port** [**tcp/udp** *port-number*] [*mask*]
 - **no dst-port**
 - **fragment** {**true** | **false**}
 - **no fragment**
 - **icmp-code** *icmp-code*
 - **no icmp-code**
 - **icmp-type** *icmp-type*
 - **no icmp-type**

- **ip-option** [*ip-option-value*] [*ip-option-mask*]
- **no ip-option**
- **multiple-option** { **true** | **false** }
- **no multiple-option**
- **option-present** { **true** | **false** }
- **no option-present**
- **port** *port-number*
- **port -list** *port-list-name*
- **port-range** *start end*
- **no port**
- **router**
- **src-ip** { *ip-address/mask* | *ip-address netmask* | **ip-prefix-list** *prefix-list-name* }
- **no src-ip**
- **src-port** [*src-port-number*] [*mask*]
- **no src-port**
- **tcp-ack** { **true** | **false** }
- **no tcp-ack**
- **tcp-syn** { **true** | **false** }
- **no tcp-syn**
- **renum** *old-entry-id new-entry-id*
- **[no] shutdown**
- **[no] ipv6-filter**
 - **[no] entry** *entry-id*
 - **action** [**accept** | **drop** | **queue** *queue-id*]
 - **no action**
 - **description** *description-string*
 - **no description**
 - **log** *log-id*
 - **no log**
 - **match** [**next-header** *next-header*]
 - **no match**
 - **dscp** *dscp-name*
 - **no dscp**
 - **dst-ip** *ipv6-address/prefix-length*
 - **dst-ip ipv6-prefix-list** *ipv6-prefix-list-name*
 - **no dst-ip**
 - **dst-port** [**tcp/udp** *port-number*] [*mask*]
 - **dst-port port-list** *port-list-name*
 - **dst-port range** *tcp/udp port-number tcp/udp port-number*
 - **no dst-port**
 - **flow-label** *value*
 - **no flow-label**
 - **fragment** { **true** | **false** }
 - **no fragment**
 - **hop-by-hop-opt** { **true** | **false** }
 - **no hop-by-hop-opt**
 - **icmp-code** *icmp-code*
 - **no icmp-code**
 - **icmp-type** *icmp-type*
 - **no icmp-type**
 - **port** *tcp/udp port-number* [*mask*]
 - **port port-list** *port-list-name*
 - **port range** *start end*

- **no port**
- **router service-name** *service-name*
- **router** *router-instance*
- **no router**
- **src-ip** [*ipv6-address/prefix-length*] [**ipv6-prefix-list** *ipv6-prefix-list-name*]
- **no src-ip**
- **src-port** [*src-port-number*] [*mask*]
- **no src-port**
- **tcp-ack** {**true** | **false**}
- **no tcp-ack**
- **tcp-syn** {**true** | **false**}
- **no tcp-syn**
- **renum** *old-entry-id new-entry-id*
- **[no] shutdown**

- **[no] mac-filter**
 - **[no] entry** *entry-id*
 - **action** [**accept** | **drop** | **queue** *queue-id*]
 - **no action**
 - **description** *description-string*
 - **no description**
 - **log** *log-id*
 - **no log**
 - **match** [**frame-type** *frame-type*]
 - **no match**
 - **cfm-opcode** {**lt** | **gt** | **eq**} *opcode*
 - **cfm-opcode range** *start end*
 - **no cfm-opcode**
 - **dsap** *dsap-value* [*dsap-mask*]
 - **dst-mac** *ieee-address* [*ieee-address-mask*]
 - **no dst-mac**
 - **etype** *0x0600..0xffff*
 - **no etype**
 - **src-mac** *ieee-address* [*ieee-address-mask*]
 - **no src-mac**
 - **ssap** *ssap-value* [*ssap-mask*]
 - **no ssap**
 - **svc-id** *service-id*
 - **no svc-id**
 - **renum** *old-entry-number new-entry-number*
 - **[no] shutdown**

CPM Queue Commands

```
config
  — system
    — security
      — [no] cpm-queue
        — [no] queue queue-id
          — cbs cbs
          — no cbs
          — mbs mbs
          — no mbs
          — rate rate [cir cir]
          — no rate
```

CPU Protection Commands

```

config
  — system
    — security
      — cpu-protection
        — ip-src-monitoring
          — included-protocols
            — [no] dhcp
        — link-specific-rate packet-rate-limit
        — no link-specific-rate
        — policy cpu-protection-policy-id [create]
        — no policy cpu-protection-policy-id
          — [no] alarm
          — description description-string
          — no description
          — eth-cfm entry entry levels levels opcodes opcodes rate packet-rate-limit
          — no eth-cfm
          — out-profile-rate packet-rate-limit [log-events]
          — no out-profile-rate
          — overall-rate packet-rate-limit
          — no overall-rate
          — per-source-rate packet-rate-limit
          — no per-source-rate
        — port-overall-rate packet-rate-limit [action-low-priority]
        — no port-overall-rate
        — [no] protocol-protection [allow-sham-links][block-pim-tunneled]

```

Refer to the OS Services Guide and the Multi-Service ISA Guide for command, syntax, and usage information about applying CPU Protection policies to interfaces.

CPU protection policies are applied by default (and customer policies can be applied) to a variety of entities including interfaces and SAPs. Refer to the appropriate guides (See Preface for document titles) for command syntax and usage for applying CPU protection policies. Examples of entities that can have CPU protection policies applied to them include:

```
configure>router>interface>cpu-protection policy-id
```

```
configure>service>epipe>sap>cpu-protection policy-id [mac-monitoring][eth-cfm-monitoring
[aggregate][car]]
```

```
configure>service>epipe>spoke-sdp>cpu-protection policy-id [mac-monitoring][eth-cfm-monitoring
[aggregate][car]]
```

```
configure>service>ies>interface>cpu-protection policy-id
```

```
configure>service>ies>interfac>sap>cpu-protection policy-id [mac-monitoring][eth-cfm-monitoring
[aggregate][car]]
```

```
configure>service>template>vpls-sap-template>cpu-protection policy-id [mac-monitoring][eth-cfm-monitoring
[aggregate][car]]
```

```
configure>service>vpls>sap>cpu-protection policy-id [mac-monitoring][eth-cfm-monitoring
[aggregate][car]]
```

```
configure>service>vpls>video-interface>cpu-protection policy-id
```

```
configure>service>vprn>interface>cpu-protection policy-id
```

```
configure>service>vprn >interface>sap>cpu-protection policy-id [mac-monitoring][eth-cfm-monitoring [aggregate][car]]
```

```
configure>service>vprn>network-interface>cpu-protection policy-id
```

```
configure>service>vprn>subscriber-interface>group-interface>sap>cpu-protection policy-id [mac-monitoring][eth-cfm-monitoring [aggregate][car]]
```

```
configure>subscriber-mgmt>msap-policy>cpu-protection policy-id [mac-monitoring ]
```

Distributed CPU Protection Commands

```
config
  — system
    — security
      — dist-cpu-protection
        — policy policy-name [create]
        — no policy
          — description description-string
          — no description
          — [no] local-monitoring-policer policer-name [create]
            — [no] description “description-string”
            — rate { packets { ppi | max } within seconds [initial-delay packets] | kbps { kilobits-per-second | max } [mbs size] [bytes|kilobytes] }
            — no rate
            — [no] log-events [verbose]
          — protocol name [create]
          — no protocol name
            — dynamic-parameters
              — detection-time seconds
              — exceed-action { discard [hold-down seconds] | low-priority [hold-down seconds] | none }
              — log-events [verbose]
              — no log-events
              — rate { packets { ppi | max } within seconds [initial-delay packets] | kbps { kilobits-per-second | max } [mbs size] [bytes|kilobytes] }
              — enforcement { static policer-name | dynamic { mon-policer-name | local-mon-bypass } }
            — static-policer policer-name [create]
            — no static-policer policer-name
              — description description-string
              — no description
              — detection-time seconds
              — no detection-time
              — exceed-action { discard [hold-down seconds] | low-priority [hold-down seconds] | none }
              — log-events [verbose]
              — no log-events
              — rate { packets { ppi | max } within seconds [initial-delay packets] | kbps { kilobits-per-second | max } [mbs size] [bytes|kilobytes] }
              — no rate
```

```
config card x fp y
```

- **dist-cpu-protection**
 - [no] **dynamic-enforcement-policer-pool** *number-of-policers*

Security Password Commands

- config
 - system
 - security
 - **password**
 - **admin-password** *password* [**hash** | **hash2**]
 - **no admin-password**
 - **aging** *days*
 - **no aging**
 - **attempts** *count* [**time** *minutes1*] [**lockout** *minutes2*]
 - **no attempts**
 - **authentication-order** [*method-1*] [*method-2*] [*method-3*] [**exit-on-reject**]
 - **no authentication-order**
 - **complexity-rules**
 - [no] **allow-user-name**
 - **credits** [**lowercase** *credits*] [**uppercase** *credits*] [**numeric** *credits*] [**special-character** *credits*]
 - **no credits**
 - **minimum-classes** *minimum*
 - **no minimum-classes**
 - **minimum-length** *length*
 - **no minimum-length**
 - **repeated-characters** *count*
 - **no repeated-characters**
 - **required** [**lowercase** *count*] [**uppercase** *count*] [**numeric** *count*] [**special-character** *count*]
 - **no required**
 - **dynsvc-password** *password* [**hash**|**hash2**]
 - **no dynsvc-password**
 - **enable-admin-control**
 - **tacplus-map-to-priv-lvl** *admin-priv-lvl*
 - **no tacplus-map-to-priv-lvl**
 - **health-check** [**interval** *interval*]
 - **no health-check**
 - **history** *size*
 - **no history**
 - **minimum-age** [**days** *days*] [**hrs** *hours*] [**min** *minutes*] [**sec** *seconds*]
 - **no minimum-age**
 - **minimum-change** *distance*
 - **no minimum-change**

Public Key Infrastructure (PKI) Commands

```

config
  — system
    — security
      — pki
        — ca-profile name [create]
        — no ca-profile name
          — cert-file filename
          — no cert-file
          — [no] accept-unprotected-errormsg
          — [no] accept-unprotected-pkiconf
          — [no] always-set-sender-for-ir
          — http-response-timeout timeout
          — no http-response-timeout
          — http-version <1.0|1.1>
          — key-list
            — key password [hash|hash2] reference reference-number
            — no key reference reference-number
          — response-signing-cert filename
          — no response-signing-cert
          — [no] same-recipnonce-for-pollreq
          — url url-string [service-id service-id]
          — no url
        — maximum-cert-chain-depth level
        — no maximum-cert-chain-depth

admin
  — certificate
    — clear-ocsp-cache [entry-id]
    — display type {cert|key|crl|cert-request} url-string format {pkcs10|pkcs12|pkcs7-der|pkcs7-pem|pem|der} [password [32 chars max]]
    — export type {cert|key|crl} input filename output url-string format output-format [password [32 chars max]] [pkey filename]
    — gen-keypair url-string [size {512|1024|2048}] [type {rsa|dsa}]
    — gen-local-cert-req keypair url-string subject-dn subject-dn [domain-name [255 chars max]] [ip-addr ip-address] file url-string [hash-alg hash-algorithm]
    — import type {cert|key|crl} input url-string output filename format input-format [password [32 chars max]]
    — reload type {cert|key} filename

```

Profile Commands

```

config
  — system
    — security
      — [no] profile user-profile-name
        — default-action {deny-all | permit-all | none}
        — [no] entry entry-id
          — action {deny | permit}
          — description description-string
          — no description
          — security command-string
          — no security
        — renum old-entry-number new-entry-number

```

RADIUS Commands

```
config
  — system
    — security
      — [no] radius
          — access-algorithm {direct | round-robin}
          — no access-algorithm
          — [no] accounting
          — accounting-port port
          — no accounting-port
          — [no] authorization
          — port port
          — no port
          — retry count
          — no retry
          — server server-index address ip-address secret key [hash | hash2]
          — no server server-index
          — [no] shutdown
          — timeout seconds
          — no timeout
          — [no] use-default-template
```

SSH Commands

```
config
  — system
    — security
      — ssh
          — [no] preserve-key
          — [no] server-shutdown
          — [no] version SSH-version
```

TACPLUS Commands

```
config
  — system
    — security
      — [no] tacplus
          — accounting [record-type {start-stop | stop-only}]
          — no accounting
          — [no] authorization [use-priv-lvl]
          — [no] interactive-authentication
          — [no] priv-lvl-map
              — priv-lvl priv-lvl user-profile-name
              — no priv-lvl priv-lvl
          — server server-index address ip-address secret key [hash | hash2] [port port]
          — no server server-index
          — [no] shutdown
          — timeout seconds
          — no timeout
          — [no] use-default-template
```

User Commands

```

config
  — system
    — security
      — [no] user user-name
        — [no] access [ftp] [snmp] [console] [li]
        — console
          — [no] cannot-change-password
          — login-exec url-prefix::source-url
          — no login-exec
          — member user-profile-name [user-profile-name... (up to 8 max)]
          — no member user-profile-name
          — [no] new-password-at-login
        — home-directory url-prefix [directory] [directory/directory...]
        — no home-directory
        — password [password] [hash | hash2]
        — [no] restricted-to-home
        — [no] rsa-key "public-key-name" key-id
        — snmp
          — authentication {[none] | [[hash] {md5 key-1 | sha key-1 } privacy
            {none|des-key|aes-128-cfb-key key-2}]}}
          — group group-name
          — no group

```

User Template Commands

```

config
  — system
    — security
      — user-template {tacplus_default | radius_default}
        — [no] access [ftp] [console]
        — console
          — login-exec url-prefix:source-url
          — no login-exec
        — home-directory url-prefix [directory][directory/directory..]
        — no home-directory
        — profile user-profile-name
        — no profile
        — [no] restricted-to-home

```

Dot1x Commands

```

config
  — system
    — security
      — dot1x
        — radius-plcy name
          — retry count
          — no retry
          — server (dot1x) server-index address ip-address secret key [port port]
          — source-address ip-address
          — [no] shutdown
          — timeout seconds
          — no timeout
        — [no] shutdown

```

Keychain Commands

```

config
  — system
    — security
      — [no] keychain keychain-name
        — description description-string
        — no description
        — direction {uni | bi}
          — bi
            — entry entry-id key [authentication-key | hash-key | hash2-key] [hash | hash2] algorithm algorithm
              — begin-time [date] [hours-minutes] [UTC] [now] [forever]
              — [no] shutdown
              — tolerance [seconds | forever]
          — uni
            — receive
            — entry entry-id key [authentication-key | hash-key | hash2-key] [hash | hash2] algorithm algorithm
              — begin-time [date] [hours-minutes] [UTC] [now] [forever]
              — end-time [date][hours-minutes] [UTC] [now] [forever]
              — [no] shutdown
              — tolerance [seconds | forever]
            — send
              — entry entry-id key [authentication-key | hash-key | hash2-key] [hash | hash2] algorithm algorithm
                — begin-time [date] [hours-minutes] [UTC] [now] [forever]
                — [no] shutdown
          — [no] shutdown
          — tcp-option-number
            — receive option-number
            — send option-number

```

TTL Security Commands

```

config
  — router
    — bgp
      — group
        — ttl-security min-ttl-value
        — neighbor
          — ttl-security min-ttl-value
config
  — router
    — ldp
      — peer-parameters
        — peer
          — ttl-security min-ttl-value
config
  — system
    — login-control
      — ssh

```

```

— ttl-security

config
— system
— login-control
— telnet
— ttl-security

```

Login Control Commands

```

config
— system
— login-control
— [no] exponential-backoff
— ftp
— inbound-max-sessions value
— no inbound-max-sessions
— idle-timeout {minutes | disable}
— no idle-timeout
— [no] login-banner
— motd {url url-prefix: source-url | text motd-text-string}
— no motd
— pre-login-message login-text-string [name]
— no pre-login-message
— ssh
— disable-graceful-shutdown
— inbound-max-sessions
— outbound-max-sessions
— ttl-security
— telnet
— enable-graceful-shutdown
— inbound-max-sessions value
— no inbound-max-sessions
— outbound-max-sessions value
— no outbound-max-sessions
— ttl-security

```

Show Commands

Security

show

— system

— security

- **access-group** [*group-name*]
- **authentication** [**statistics**]
- **communities**
- **cpm-filter**
 - **ip-filter** [**entry** *entry-id*]
 - **ipv6-filter** [**entry** *entry-id*]
 - **mac-filter** [**entry** *entry-id*]
- **cpm-queue** *queue-id*
- **cpu-protection**
 - **eth-cfm-monitoring** [{**service-id** *service-id* **sap-id** *sap-id* } | {**service-id** *service-id* **sdp-id** *sdp-id:vc-id* }]
 - **excessive-sources** [**service-id** *service-id* **sap-id** *sap-id*]
 - **policy** [*policy-id*] **association**
 - **protocol-protection**
 - **violators** [**port**] [**interface**] [**sap**] [**video**] [**sdp**]
- **dist-cpu-protection**
 - **policy** [*policy-id*] [**association** **detail**]
- **keychain** *keychain-name* [**detail**]
- **management-access-filter**
 - **ip-filter** [**entry** *entry-id*]
 - **ipv6-filter** [**entry** *entry-id*]
 - **mac-filter** [**entry** *entry-id*]
- **password-options**
- **per-peer-queuing** [**detail**]
- **per-peer-queuing**
- **profile** [*user-profile-name*]
- **source-address**
- **ssh**
- **user** [*user-name*] [**detail**]
- **user** [*user-name*] **lockout**
- **view** [*view-name*] [**detail**]

— **certificate**

- **ca-profile**
- **ca-profile** *name* [**association**]
- **ocsp-cache** [*entry-id*]
- **statistics**

show

— card

— fp

- **dist-cpu-protection**

show

— service

— id

— sap

- **dist-cpu-protection** [**detail**]

show

- router
 - interface
 - **dist-cpu-protection** [detail]

Login Control

- show
 - **user**

Clear Commands

- clear
 - router
 - authentication
 - **statistics** [interface *ip-int-name* | *ip-address*]
 - **radius-proxy-server** *server-name* **statistics**
 - **cpm-filter**
 - **ip-filter** [entry *entry-id*]
 - **ipv6-filter** [entry *entry-id*]
 - **mac-filter** [entry *entry-id*]
 - **cpu-protection**
 - **excessive-sources**
 - **protocol-protection**
 - **violators** [port] [interface] [sap]
 - **cpm-queue** *queue-id*
 - admin
 - user
 - user
 - **clear** **lockout** {*name* | **all**}
 - **clear** **password-history** {*name* | **all**}

Debug Commands

- debug
 - **radius** [detail] [hex]
 - **no radius**
 - [no] **ocsp**
 - [no] **ocsp** *profile-name*

Tools Commands

- tools
 - dump
 - security
 - **dist-cpu-protection**
 - **violators** **enforcement** {sap|interface} **card** *slot-number* [**fp** *fp-number*]
 - **violators** **local-monitor** {sap|interface} **card** *slot-number* [**fp** *fp-number*]
 - perform
 - security
 - **dist-cpu-protection**
 - **release-hold-down** **interface** *interface-name* [**protocol** *protocol*] [**static-policer** *name*]
 - **release-hold-down** **sap** *sap-id* [**protocol** *protocol*] [**static-policer** *name*]

Configuration Commands

General Security Commands

description

Syntax	description <i>description-string</i> no description
Context	config>system>security>mgmt-access-filter>ip-filter>entry config>system>security>mgmt-access-filter>ipv6-filter>entry config>sys>sec>cpm>ip-filter>entry config>sys>sec>cpm>ipv6-filter>entry config>sys>sec>cpm>mac-filter>entry config>sys>security>keychain>direction>bi>entry config>system>security>keychain>direction>uni>receive>entry config>system>security>keychain>direction>uni>send>entry config>system>security>pki>ca-profile config>sys>security>cpu-protection>policy config>system>security>mgmt-access-filter>mac-filter>entry config>system>security>cpm-filter>mac-filter>entry
Description	This command creates a text description stored in the configuration file for a configuration context. This command associates a text string with a configuration context to help identify the context in the configuration file. The no form of the command removes the string.
Default	No description associated with the configuration context.
Parameters	<i>string</i> — The description character string. Allowed values are any string up to 80 characters long composed of printable, 7-bit ASCII characters. If the string contains special characters (#, \$, spaces, etc.), the entire string must be enclosed within double quotes.

shutdown

Syntax	[no] shutdown
Context	config>system>security>mgmt-access-filter>ip-filter config>system>security>mgmt-access-filter>ipv6-filter config>sys>sec>cpm>ip-filter config>system>security>keychain>direction>bi>entry config>system>security>keychain>direction>uni>receive>entry

General Security Commands

```
config>system>security>keychain>direction>uni>send>entry
config>system>security>pki>ca-profile
config>sys>sec>cpm>ipv6-filter
config>sys>sec>cpm>mac-filter>entry
```

Description The **shutdown** command administratively disables the entity. When disabled, an entity does not change, reset, or remove any configuration settings or statistics. Many entities must be explicitly enabled using the **no shutdown** command. The operational state of the entity is disabled as well as the operational state of any entities contained within. Many objects must be shut down before they may be deleted.

The **no** form of the command puts an entity into the administratively enabled state.

Default no shutdown

security

Syntax **security**

Context config>system

Description This command creates the context to configure security settings.
Security commands manage user profiles and user membership. Security commands also manage user login registrations.

ftp-server

Syntax **[no] ftp-server**

Context config>system>security

Description This command enables FTP servers running on the system.
FTP servers are disabled by default. At system startup, only SSH server are enabled.
The **no** form of the command disables FTP servers running on the system.

hash-control

Syntax **hash-control [read-version {1 | 2 | all}] [write-version {1 | 2}]
no hash-control**

Context config>system>security

Description Whenever the user executes a **save** or **info** command, the system will encrypt all passwords, MD5 keys, etc., for security reasons. At present, two algorithms exist.

The first algorithm is a simple, short key that can be copied and pasted in a different location when the user wants to configure the same password. However, because it is the same password and the hash key is limited to the password/key, even the casual observer will notice that it is the same key.

The second algorithm is a more complex key, and cannot be copied and pasted in different locations in the configuration file. In this case, if the same key or password is used repeatedly in different contexts, each encrypted (hashed) version will be different.

Default all — read-version set to accept both versions 1 and 2

Parameters **read-version** { **1** | **2** | **all** } — When the read-version is configured as “all,” both versions 1 and 2 will be accepted by the system. Otherwise, only the selected version will be accepted when reading configuration or exec files. The presence of incorrect hash versions will abort the script/startup.

write-version { **1** | **2** } — Select the hash version that will be used the next time the configuration file is saved (or an info command is executed). Be careful to save the read and write version correctly, so that the file can be properly processed after the next reboot or exec.

per-peer-queuing

Syntax [no] per-peer-queuing

Context config>system>security

Description This command enables CPM hardware queuing per peer. This means that when a peering session is established, the router will automatically allocate a separate CPM hardware queue for that peer.

The **no** form of the command disables CPM hardware queuing per peer.

Default per-peer-queuing

source-address

Syntax source-address

Context config>system>security

Description This command specifies the source address that should be used in all unsolicited packets sent by the application.

This feature only applies on inband interfaces and does not apply on the outband management interface. Packets going out the management interface will keep using that as source IP address. IN other words, when the RADIUS server is reachable through both the management interface and a network interface, the management interface is used despite whatever is configured under the source-address statement.

When a source address is specified for the **ptp** application, the port-based 1588 hardware timestamping assist function will be applied to PTP packets matching the IPv4 address of the router interface used to ingress the SR/ESS or IP address specified in this command. If the IP address is removed, then the port-based 1588 hardware timestamping assist function will only be applied to PTP packets matching the IPv4 address of the router interface.

application

Syntax	application <i>app</i> [<i>ip-int-name</i> <i>ip-address</i>] no application <i>app</i>
Context	config>system>security>source-address
Description	This command specifies the use of the source IP address specified by the source-address command.
Parameters	<i>app</i> — Specify the application name. Values cflowd, dns, ftp, ntp, ping, ptp, radius, snmptrap, sntp, ssh, syslog, tacplus, telnet, traceroute, mcreporter <i>ip-int-name</i> / <i>ip-address</i> — Specifies the name of the IP interface or IP address. If the string contains special characters (#, \$, spaces, etc.), the entire string must be enclosed within double quotes.

application6

Syntax	application6 <i>app</i> <i>ipv6-address</i> no application6
Context	config>system>security>source-address
Description	This command specifies the application to use the source IPv6 address specified by the source-address command.
Parameters	<i>app</i> — Specify the application name. Values cflowd, dns, ftp, ntp, ping, radius, snmptrap, syslog, tacplus, telnet, traceroute <i>ipv6-address</i> — Specifies the name of the IPv6 address.

telnet-server

Syntax	[no] telnet-server
Context	config>system>security
Description	This command enables Telnet servers running on the system. Telnet servers are off by default. At system startup, only SSH servers are enabled. Telnet servers in networks limit a Telnet clients to three retries to login. The Telnet server disconnects the Telnet client session after three retries. The no form of the command disables Telnet servers running on the system.

telnet6-server

- Syntax** `[no] telnet6-server`
- Context** `config>system>security`
- Description** This command enables Telnet IPv6 servers running on the system. Telnet servers are off by default. At system startup, only SSH server are enabled. The **no** form of the command disables Telnet IPv6 servers running on the system.

vprn-network-exceptions

- Syntax** `vprn-network-exceptions number seconds`
- Context** `config>system>security`
- Description** This command configures the rate to limit ICMP replies to packets with label TTL expiry received within all VPRN sentences in the system and from all network IP interfaces. This includes labeled user packets, ping and traceroute packets within VPRN. This feature currently also limits the same packets when received within the context of an LSP short-cut. This feature does not rate limit MPLS and service OAM packets such as vprn-ping, vprn-trace, lsp-ping, lsp-trace, vccv-ping, and vccv-trace. The **no** form of the command disables the rate limiting of the reply to these packets.
- Default** `no security vprn-network-exceptions`
- Parameters** *number* — 10 — 10,000
seconds — 1 — 60

LLDP Commands

lldp

Syntax	lldp
Context	config>system
Description	This command enables the context to configure system-wide Link Layer Discovery Protocol parameters.

message-fast-tx

Syntax	message-fast-tx <i>time</i> no message-fast-tx
Context	config>system>lldp
Description	This command configures the duration of the fast transmission period.
Parameters	<i>time</i> — Specifies the fast transmission period in seconds. Values 1 — 3600 Default 1

message-fast-tx-init

Syntax	message-fast-tx-init <i>count</i> no message-fast-tx-init
Context	config>system>lldp
Description	This command configures the number of LLDPDUs to send during the fast transmission period.
Parameters	<i>count</i> — Specifies the number of LLDPDUs to send during the fast transmission period. Values 1 — 8 Default 4

notification-interval

Syntax	notification-interval <i>time</i> no notification-interval
Context	config>system>lldp
Description	This command configures the minimum time between change notifications.
Parameters	<i>time</i> — Specifies the minimum time, in seconds, between change notifications.
	Values 5 — 3600
	Default 5

reinit-delay

Syntax	reinit-delay <i>time</i> no reinit-delay
Context	config>system>lldp
Description	This command configures the time before re-initializing LLDP on a port.
Parameters	<i>time</i> — Specifies the time, in seconds, before re-initializing LLDP on a port.
	Values 1 — 10
	Default 2

tx-credit-max

Syntax	tx-credit-max <i>count</i> no tx-credit-max
Context	config>system>lldp
Description	This command configures the maximum consecutive LLDPDUs transmitted.
Parameters	<i>count</i> — Specifies the maximum consecutive LLDPDUs transmitted.
	Values 1 — 100
	Default 5

tx-hold-multiplier

Syntax	tx-hold-multiplier <i>multiplier</i> no tx-hold-multiplier
Context	config>system>lldp
Description	This command configures the multiplier of the tx-interval.
Parameters	<i>multiplier</i> — Specifies the multiplier of the tx-interval.
Values	2 — 10
Default	4

tx-interval

Syntax	tx-interval <i>interval</i> no tx-interval
Context	config>system>lldp
Description	This command configures the LLDP transmit interval time.
Parameters	<i>interval</i> — Specifies the LLDP transmit interval time.
Values	1 — 100
Default	5

Login, Telnet, SSH and FTP Commands

exponential-backoff

Syntax	[no] exponential-backoff
Context	config>system>login-control
Description	This command enables the exponential-backoff of the login prompt. The exponential-backoff command is used to deter dictionary attacks, when a malicious user can gain access to the CLI by using a script to try admin with any conceivable password. The no form of the command disables exponential-backoff.
Default	no exponential-backoff

ftp

Syntax	ftp
Context	config>system>login-control
Description	This command creates the context to configure FTP login control parameters.

idle-timeout

Syntax	idle-timeout { <i>minutes</i> disable } no idle-timeout
Context	config>system>login-control
Description	This command configures the idle timeout for FTP, console, or Telnet sessions before the session is terminated by the system. By default, an idle FTP, console, SSH or Telnet session times out after 30 minutes of inactivity. This timer can be set per session. The no form of the command reverts to the default value.
Default	30 — Idle timeout set for 30 minutes.
Parameters	<i>minutes</i> — The idle timeout in minutes. Allowed values are 1 to 1440. 0 implies the sessions never timeout. Values 1 — 1440 disable — When the disable option is specified, a session will never timeout. To re-enable idle timeout, enter the command without the disable option.

inbound-max-sessions

Syntax	inbound-max-sessions <i>value</i> no inbound-max-sessions
Context	config>system>login-control>ftp
Description	This command configures the maximum number of concurrent inbound FTP sessions. This value is the combined total of inbound and outbound sessions. The no form of the command reverts to the default value.
Default	3
Parameters	<i>value</i> — The maximum number of concurrent FTP sessions on the node. Values 0 — 5

inbound-max-sessions

Syntax	inbound-max-sessions <i>value</i> no inbound-max-sessions
Context	config>system>login-control>telnet
Description	This parameter limits the number of inbound Telnet and SSH sessions. A maximum of 15 telnet and ssh connections can be established to the router. The local serial port cannot be disabled. The no form of the command reverts to the default value.
Default	5
Parameters	<i>value</i> — The maximum number of concurrent inbound Telnet sessions, expressed as an integer. Values 0 — 15

login-banner

Syntax	[no] login-banner
Context	config>system>login-control
Description	This command enables or disables the display of a login banner. The login banner contains the 7750 SR OS copyright and build date information for a console login attempt. The no form of the command causes only the configured pre-login-message and a generic login prompt to display.

login-control

Syntax	login-control
Context	config>system
Description	This command creates the context to configure the session control for console, Telnet and FTP.

motd

Syntax	motd { <i>url url-prefix: source-url</i> text <i>motd-text-string</i> } no motd
Context	config>system>login-control
Description	This command creates the message of the day displayed after a successful console login. Only one message can be configured. The no form of the command removes the message.
Default	No motd is defined.
Parameters	url <i>url-prefix: source-url</i> — When the message of the day is present as a text file, provide both url-prefix and the source-url of the file containing the message of the day. The URL prefix can be local or remote. text <i>motd-text-string</i> — The text of the message of the day. The <i>motd-text-string</i> must be enclosed in double quotes. Multiple text strings are not appended to one another. Some special characters can be used to format the message text. The “\n” character creates multi-line MOTDs and the “\r” character restarts at the beginning of the new line. For example, entering “\n\r” will start the string at the beginning of the new line, while entering “\n” will start the second line below the last character from the first line.

outbound-max-sessions

Syntax	outbound-max-sessions <i>value</i> no outbound-max-sessions
Context	config>system>login-control>telnet
Description	This parameter limits the number of outbound Telnet and SSH sessions. A maximum of 15 telnet and ssh connections can be established from the router. The local serial port cannot be disabled. The no form of the command reverts to the default value.
Default	5
Parameters	<i>value</i> — The maximum number of concurrent outbound Telnet sessions, expressed as an integer. Values 0 — 15

pre-login-message

Syntax	pre-login-message <i>login-text-string</i> [name] no pre-login-message
Context	config>system>login-control
Description	<p>This command creates a message displayed prior to console login attempts on the console via Telnet. Only one message can be configured. If multiple pre-login-messages are configured, the last message entered overwrites the previous entry.</p> <p>It is possible to add the name parameter to an existing message without affecting the current pre-login-message.</p> <p>The no form of the command removes the message.</p>
Default	No pre-login-message is defined.
Parameters	<p><i>login-text-string</i> — The string can be up to 900 characters. Any printable, 7-bit ASCII characters can be used. If the string contains special characters (#, \$, spaces, etc.), the entire string must be enclosed within double quotes. Some special characters can be used to format the message text. The \n character creates multiline messages and the \r character restarts at the beginning of the new line. For example, entering \n\r will start the string at the beginning of the new line, while entering \n will start the second line below the last character from the first line.</p> <p>name — When the keyword <i>name</i> is defined, the configured system name is always displayed first in the login message. To remove the name from the login message, the message must be cleared and a new message entered without the name.</p>

ssh

Syntax	ssh
Context	config>system>login-control
Description	This command enables the context to configure the SSH parameters.

disable-graceful-shutdown

Syntax	[no] disable-graceful-shutdown
Context	config>system>login-control>ssh
Description	<p>This command enables graceful shutdown of SSH sessions.</p> <p>The no form of the command disables graceful shutdown of SSH sessions.</p>

preserve-key

Syntax	[no] preserve-key
Context	config>system>security>ssh
Description	After enabling this command, private keys, public keys, and host key file will be saved by the server. It is restored following a system reboot or the ssh server restart. The no form of the command specifies that the keys will be held in memory by the SSH server and is not restored following a system reboot.
Default	no preserve-key

server-shutdown

Syntax	[no] server-shutdown
Context	config>system>security>ssh
Description	This command enables the SSH servers running on the system.
Default	At system startup, only the SSH server is enabled.

version

Syntax	version <i>ssh-version</i> no version
Context	config>system>security>ssh
Description	Specifies the SSH protocol version that will be supported by the SSH server.
Default	2
Parameters	<i>ssh-version</i> — Specifies the SSH version.
Values	<ul style="list-style-type: none"> 1 — Specifies that the SSH server will only accept connections from clients that support SSH protocol version 1 2 — Specifies that the SSH server will accept connections from clients supporting either SSH protocol version 2 1-2 — Specifies that the SSH server will accept connections from clients supporting either SSH protocol version 1, or SSH protocol version 2 or both.

telnet

Syntax	telnet
Context	config>system>login-control
Description	This command creates the context to configure the Telnet login control parameters.

enable-graceful-shutdown

Syntax	[no] enable-graceful-shutdown
Context	config>system>login-control>telnet
Description	This command enables graceful shutdown of telnet sessions. The no form of the command disables graceful shutdown of telnet sessions.

Management Access Filter Commands

management-access-filter

Syntax	<code>[no] management-access-filter</code>
Context	<code>config>system>security</code>
Description	<p>This command creates the context to edit management access filters and to reset match criteria.</p> <p>Management access filters control all traffic in and out of the CPM. They can be used to restrict management of the router by other nodes outside either specific (sub)networks or through designated ports.</p> <p>Management filters, as opposed to other traffic filters, are enforced by system software.</p> <p>The no form of the command removes management access filters from the configuration.</p>
Default	No management access filters are defined.

ip-filter

Syntax	<code>[no] ip-filter</code>
Context	<code>config>system>security>mgmt-access-filter</code>
Description	This command enables the context to configure management access IP filter parameters.

ipv6-filter

Syntax	<code>[no] ipv6-filter</code>
Context	<code>config>system>security>mgmt-access-filter</code>
Description	This command enables the context to configure management access IPv6 filter parameters.

mac-filter

Syntax	<code>[no] mac-filter</code>
Context	<code>config>system>security>mgmt-access-filter</code>
Description	This command configures a management access MAC-filter.

action

Syntax	action { permit deny deny-host-unreachable } no action
Context	config>system>security>mgmt-access-filter>ip-filter>entry config>system>security>mgmt-access-filter>ipv6-filter>entry config>system>security>mgmt-access-filter>mac-filter
Description	This command creates the action associated with the management access filter match criteria entry. The action keyword is required. If no action is defined, the filter is ignored. If multiple action statements are configured, the last one overwrites previous configured actions. If the packet does not meet any of the match criteria the configured default action is applied.
Default	none — The action is specified by default-action command.
Parameters	permit — Specifies that packets matching the configured criteria will be permitted. deny — Specifies that packets matching the configured selection criteria will be denied and that a ICMP host unreachable message will not be issued. deny-host-unreachable — Specifies that packets matching the configured selection criteria will be denied and that a host unreachable message will not be issued. Note: deny-host-unreachable only applies to ip-filter and ipv6filter.

default-action

Syntax	default-action { permit deny deny-host-unreachable }
Context	config>system>security>mgmt-access-filter>ip-filter config>system>security>mgmt-access-filter>ipv6-filter config>system>security>mgmt-access-filter>mac-filter
Description	This command creates the default action for management access in the absence of a specific management access filter match. The default-action is applied to a packet that does not satisfy any match criteria in any of the management access filters. Whenever management access filters are configured, the default-action must be defined.
Default	No default-action is defined.
Parameters	permit — Specifies that packets not matching the configured selection criteria in any of the filter entries will be permitted. deny — Specifies that packets not matching the selection criteria be denied and that an ICMP host unreachable message will not be issued. deny-host-unreachable — Specifies that packets not matching the selection criteria be denied access and that an ICMP host unreachable message will be issued. Note: deny-host-unreachable only applies to ip-filter and ipv6filter.

dst-port

- Syntax** `[no] dst-port value [mask]`
- Context** `config>system>security>mgmt-access-filter>ip-filter>entry`
`config>system>security>mgmt-access-filter>ipv6-filter>entry`
- Description** This command configures a source TCP or UDP port number or port range for a management access filter match criterion.
- The **no** form of the command removes the source port match criterion.
- Default** No dst-port match criterion.
- Parameters** *value* — The source TCP or UDP port number as match criteria.
- Values** 1 — 65535 (decimal)
- mask* — Mask used to specify a range of source port numbers as the match criterion.
- This 16 bit mask can be configured using the following formats:

Format Style	Format Syntax	Example
Decimal	DDDDD	63488
Hexadecimal	0xHHHH	0xF800
Binary	0BBBBBBBBBBBBBBBB	0b1111100000000000

To select a range from 1024 up to 2047, specify 1024 0xFC00 for value and mask.

Default 65535 (exact match)

Values 1 — 65535 (decimal)

entry

- Syntax** `[no] entry entry-id`
- Context** `config>system>security>mgmt-access-filter>ip-filter`
`config>system>security>mgmt-access-filter>ipv6-filter`
`config>system>security>mgmt-access-filter>mac-filter`
- Description** This command is used to create or edit a management access IP(v4), IPv6, or MAC filter entry. Multiple entries can be created with unique *entry-id* numbers. The OS exits the filter upon the first match found and executes the actions according to the respective action command. For this reason, entries must be sequenced correctly from most to least explicit.
- An entry may not have any match criteria defined (in which case, everything matches) but must have at least the keyword **action** defined to be considered complete. Entries without the **action** keyword are considered incomplete and inactive.

Management Access Filter Commands

The **no** form of the command removes the specified entry from the management access filter.

Default No entries are defined.

Parameters *entry-id* — An entry ID uniquely identifies a match criteria and the corresponding action. It is recommended that entries are numbered in staggered increments. This allows users to insert a new entry in an existing policy without having to renumber the existing entries.

Values 1 — 9999

flow-label

Syntax **flow-label** *value*
no flow-label

Context config>system>security>mgmt-access-filter>ipv6-filter>entry

Description This command configures flow label match conditions. Flow labeling enables the labeling of packets belonging to particular traffic flows for which the sender requests special handling, such as non-default quality of service or real-time service.

Parameters *value* — Specify the flow identifier in an IPv6 packet header that can be used to discriminate traffic flows (See RFC 3595, *Textual Conventions for IPv6 Flow Label*.)

Values 0 — 1048575

log

Syntax [**no**] log

Context config>system>security>mgmt-access-filter>ip-filter>entry
config>system>security>mgmt-access-filter>ipv6-filter>entry
config>system>security>mgmt-access-filter>mac-filter

Description This command enables match logging. When enabled, matches on this entry will cause the Security event mafEntryMatch to be raised.

Default no log

next-header

Syntax **next-header** *next-header*
no next-header

Context config>system>security>mgmt-access-filter>ipv6-filter>entry

Description	This command specifies the next header to match. The protocol type such as TCP / UDP / OSPF is identified by its respective protocol number. Well-known protocol numbers include ICMP(1), TCP(6), UDP(17). IPv6 Extension headers are identified by the next header IPv6 numbers as per RFC2460.
Parameters	<i>next-header</i> — Specifies for IPv4 MAF the IP protocol field, and for IPv6 the next header type to be used in the match criteria for this Management Access Filter Entry.
Values	next-header: 0 — 255, protocol numbers accepted in DHB keywords: none, crtp, crudp, egp, eigrp, encap, ether-ip, gre, icmp, idrp, igmp, igp, ip, ipv6, ipv6-icmp, ipv6-no-nxt, isis, iso-ip, l2tp, ospf-igp, pim, pnni, ptp, rdp, rsvp, stp, tcp, udp, vrrp

protocol

Syntax	[no] protocol <i>protocol-id</i>
Context	config>system>security>mgmt-access-filter>ip-filter>entry
Description	This command configures an IP protocol type to be used as a management access filter match criterion. The protocol type, such as TCP, UDP, and OSPF, is identified by its respective protocol number. Well-known protocol numbers include ICMP (1), TCP (6), and UDP (17). The no form the command removes the protocol from the match criteria.
Default	No protocol match criterion is specified.
Parameters	<i>protocol</i> — The protocol number for the match criterion.
Values	1 to 255 (decimal)

port

Syntax	port <i>tcp/udp port-number</i> [<i>mask</i>] port-list <i>port-list-name</i> port range <i>start end</i> no port
Context	config>system-security>cpm-filter>ip-filter>entry>match config>system-security>cpm-filter>ipv6-filter>entry>match
Description	This command configures a TCP/UDP source or destination port match criterion in IPv4 and IPv6 CPM filter policies. A packet matches this criterion if packet's TCP/UDP (as configured by protocol/next-header match) source OR destination port matches either the specified port value or a port in the specified port range or port list. This command is mutually exclusive with src-port and dst-port commands. The no form of this command deletes the specified port match criterion.

Management Access Filter Commands

Default **no port**

Parameters *port-number* — A source or destination port to be used as a match criterion specified as a decimal integer.

Values 1 -65535

mask — Specifies the 16 bit mask to be applied when matching the port.

Values [0x0000..0xFFFF] | [0..65535] | [0b0000000000000000..0b1111111111111111]

range *start end* — an inclusive range of source or destination port values to be used as match criteria. *start* of the range and *end* of the range are expressed as decimal integers.

Values start, end, port-number: 1 -65535

port-list *port-list-name* — A string of up to 32 characters of printable ASCII characters. If special characters are used, the string must be enclosed within double quotes.

router

Syntax **router service-name service-name**
router {router-instance}
no router

Context config>system>security>mgmt-access-filter>ip-filter>entry
config>system>security>mgmt-access-filter>ipv6-filter>entry

Description This command configures a router name or service ID to be used as a management access filter match criterion.

The **no** form the command removes the router name or service ID from the match criteria.

Parameters *router-instance* — Specify one of the following parameters for the router instance:

router-name — Specifies a router name up to 32 characters to be used in the match criteria.

service-id — Specifies an existing service ID to be used in the match criteria.

Values 1 — 2147483647

service-name *service-name* — Specifies an existing service name up to 64 characters in length.

renum

Syntax **renum old-entry-number new-entry-number**

Context config>system>security>mgmt-access-filter>ip-filter
config>system>security>mgmt-access-filter>ipv6-filter
config>system>security>mgmt-access-filter>mac-filter

Description This command renumbers existing management access filter entries for an IP(v4), IPv6, or MAC filter to re-sequence filter entries.

The exits on the first match found and executes the actions in accordance with the accompanying **action** command. This may require some entries to be re-numbered differently from most to least explicit.

Parameters *old-entry-number* — Enter the entry number of the existing entry.

Values 1 — 9999

new-entry-number — Enter the new entry number that will replace the old entry number.

Values 1 — 9999

shutdown

Syntax [no] shutdown

Context config>system>security>mgmt-access-filter>ip-filter
config>system>security>mgmt-access-filter>ipv6-filter
config>system>security>mgmt-access-filter>mac-filter

Description This command shutdowns the management-access-filter.

match

Syntax match [frame-type *frame-type*]
no match

Context config>system>security>mgmt-access-filter>mac-filter>entry

Description This command configures math criteria for this MAC filter entry.

Parameters *frame-type frame-type* — Specifies the type of MAC frame to use as match criteria.

Values none, 802dot2-llc, ethernet_II

cfm-opcode

Syntax cfm-opcode {lt | gt | eq} *opcode*
cfm-opcode range *start end*
no cfm-opcode

Context config>system>security>mgmt-access-filter>mac-filter>entry

Description This command specifies the type of opcode checking to be performed.

If the cfm-opcode match condition is configured then a check must be made to see if the Ethertype is either IEEE802.1ag or Y1731. If the Ethertype does not match then the packet is not CFM and no match to the cfm-opcode is attempted.

The CFM (ieee802.1ag or Y1731) opcode can be assigned as a range with a start and an end number or with a (less than lt, greater than gt, or equal to eq) operator.

If no range with a start and an end or operator (lt, gt, eq) followed by an opcode with the value between 0 and 255 is defined then the command is invalid.

The following table provides opcode values.

Table 8: Opcode Values

CFM PDU or Organization	Acronym	Configurable Numeric Value (Range)
Reserved for IEEE 802.1 0		0
Continuity Check Message	CCM	1
Loopback Reply	LBR	2
Loopback Message	LBM	3
Linktrace Reply	LTR	4
Linktrace Message	LTM	5
Reserved for IEEE 802.1		6 – 31
Reserved for ITU		32
	AIS	33
Reserved for ITU		34
	LCK	35
Reserved for ITU		36
	TST	37
Reserved for ITU		38
	APS	39
Reserved for ITU		40
	MCC	41
	LMR	42
	LMM	43
Reserved for ITU		44
	1DM	45
	DMR	46
	DMM	47
Reserved for ITU		48 – 63
Reserved for IEEE 802.1 0		64 - 255

Defined by ITU-T Y.1731 32 - 63
 Defined by IEEE 802.1. 64 - 255

Default no cfm-opcode

Parameters *opcode* — Specifies the opcode checking to be performed.

start — specifies the start number.

Values 0 — 255

end — Specifies the end number.

Values 0 — 255

lt|gt|eq — keywords

dot1p

Syntax **dot1p** *dot1p-value* [*dot1p-mask*]

Context config>system>security>mgmt-access-filter>mac-filter>entry>match

Description This command configures Dot1p match conditions.

Parameters *dot1p-value* — The IEEE 802.1p value in decimal.

Values 0 — 7

mask — This 3-bit mask can be configured using the following formats:

Values 0 — 7

dsap

Syntax **dsap** *dsap-value* [*dsap-mask*]

Context config>system>security>mgmt-access-filter>mac-filter>entry>match

Description This command configures dsap match conditions.

Format Style	Format Syntax	Example
Decimal	D	4
Hexadecimal	0xH	0x4
Binary	0bBBB	0b100

Parameters *dsap-value* — The 8-bit dsap match criteria value in hexadecimal.

Values 0x00 — 0xFF (hex)

Management Access Filter Commands

mask — This is optional and may be used when specifying a range of dsap values to use as the match criteria.

This 8 bit mask can be configured using the following formats:

Format Style	Format Syntax	Example
Decimal	DDD	240
Hexadecimal	0xHH	0xF0
Binary	0bBBBBBBBB	0b11110000
Default	FF (hex) (exact match)	
Values	0x00 — 0xFF	

dst-mac

Syntax	dst-mac <i>ieee-address</i> [<i>ieee-address-mask</i>] no dst-mac
Context	config>system>security>mgmt-access-filter>mac-filter>entry>match
Description	This command configures the destination MAC match condition.
Parameters	<i>ieee-address</i> — The MAC address to be used as a match criterion. Values HH:HH:HH:HH:HH:HH or HH-HH-HH-HH-HH-HH where H is a hexadecimal digit <i>mask</i> — A 48-bit mask to match a range of MAC address values.

etype

Syntax	etype <i>0x0600xx0xffff</i> no etype
Context	config>system>security>mgmt-access-filter>mac-filter>entry>match
Description	<p>Configures an Ethernet type II Ethertype value to be used as a MAC filter match criterion.</p> <p>The Ethernet type field is a two-byte field used to identify the protocol carried by the Ethernet frame. For example, 0800 is used to identify the IPv4 packets.</p> <p>The Ethernet type field is used by the Ethernet version-II frames. IEEE 802.3 Ethernet frames do not use the type field. For IEEE 802.3 frames, use the dsap, ssap or snap-pid fields as match criteria.</p> <p>The snap-pid field, etype field, ssap and dsap fields are mutually exclusive and may not be part of the same match criteria. Refer to the Router Configuration Guide for information about MAC Match Criteria Exclusivity Rules fields that are exclusive based on the frame format.</p> <p>The no form of the command removes the previously entered etype field as the match criteria.</p>
Default	no etype
Parameters	<p><i>ethernet-type</i> — The Ethernet type II frame Ethertype value to be used as a match criterion expressed in hexadecimal.</p> <p>Values 0x0600 — 0xFFFF</p>

snap-oui

Syntax	snap-oui { zero non-zero }
Context	config>system>security>mgmt-access-filter>mac-filter>entry>match
Description	<p>This command configures an IEEE 802.3 LLC SNAP Ethernet Frame OUI zero or non-zero value to be used as a MAC filter match criterion.</p> <p>The no form of the command removes the criterion from the match criteria.</p>
Default	no snap-oui
Parameters	<p>zero — Specifies to match packets with the three-byte OUI field in the SNAP-ID set to zero.</p> <p>non-zero — Specifies to match packets with the three-byte OUI field in the SNAP-ID not set to zero.</p>

snap-pid

Syntax	snap-pid <i>snap-pid</i> no snap-pid
Context	config>system>security>mgmt-access-filter>mac-filter>entry>match
Description	This command configures an IEEE 802.3 LLC SNAP Ethernet Frame PID value to be used as a MAC

filter match criterion.

This is a two-byte protocol id that is part of the IEEE 802.3 LLC SNAP Ethernet Frame that follows the three-byte OUI field.

The snap-pid field, etype field, ssap and dsap fields are mutually exclusive and may not be part of the same match criteria. Refer to the Router Configuration Guide for information about MAC Match Criteria Exclusivity Rules fields that are exclusive based on the frame format.

Note: The snap-pid match criterion is independent of the OUI field within the SNAP header. Two packets with different three-byte OUI fields but the same PID field will both match the same filter entry based on a snap-pid match criteria.

The **no** form of the command removes the snap-pid value as the match criteria.

Default no snap-pid

Parameters *pid-value* — The two-byte snap-pid value to be used as a match criterion in hexadecimal.

Values 0x0000 — 0xFFFF

src-mac

Syntax **src-mac** *ieee-address* [*ieee-address-mask*]
no src-mac

Context config>system>security>mgmt-access-filter>mac-filter>entry>match

Description This command configures a source MAC address or range to be used as a MAC filter match criterion. The **no** form of the command removes the source mac as the match criteria.

Default no src-mac

Parameters *ieee-address* — Enter the 48-bit IEEE mac address to be used as a match criterion.

Values HH:HH:HH:HH:HH:HH or HH-HH-HH-HH-HH-HH where H is a hexadecimal digit

ieee-address-mask — This 48-bit mask can be configured using:

Format Style	Format Syntax	Example
Decimal	DDDDDDDDDDDDDD	281474959933440
Hexadecimal	0xHHHHHHHHHHHH	0xFFFFF000000
Binary	0BBBBBBB...B	0b11110000...B

To configure so that all packets with a source MAC OUI value of 00-03-FA are subject to a match condition then the entry should be specified as: 003FA000000 0xFFFFF000000

Default 0xFFFFFFFFFFFF (exact match)

Values 0x0000000000000000 — 0xFFFFFFFFFFFF

ssap

Syntax	ssap <i>ssap-value</i> [<i>ssap-mask</i>] no ssap
Context	config>system>security>mgmt-access-filter>mac-filter>entry>match
Description	This command configures an Ethernet 802.2 LLC SSAP value or range for a MAC filter match criterion. This is a one-byte field that is part of the 802.2 LLC header of the IEEE 802.3 Ethernet Frame. The snap-pid field, etype field, ssap and dsap fields are mutually exclusive and may not be part of the same match criteria. Refer to the Router Configuration Guide for information about MAC Match Criteria Exclusivity Rules fields that are exclusive based on the frame format. The no form of the command removes the ssap match criterion.
Default	no ssap
Parameters	<i>ssap-value</i> — The 8-bit ssap match criteria value in hex. Values 0x00 — 0xFF <i>ssap-mask</i> — This is optional and may be used when specifying a range of ssap values to use as the match criteria.

svc-id

Syntax	svc-id <i>service-id</i> no svc-id
Context	config>system>security>mgmt-access-filter>mac-filter>entry>match
Description	This command specifies an existing svc-id to use as a match condition.
Parameters	<i>service-id</i> — Specifies a service-id to match. Values <i>service-id:</i> 1 — 2147483647 <i>svc-name:</i> 64 characters maximum

src-port

Syntax	src-port { <i>port-id</i> cpm lag <i>port-id</i> } no src-port
Context	config>system>security>mgmt-access-filter>ip-filter>entry config>system>security>mgmt-access-filter>ipv6-filter>entry
Description	This command restricts ingress management traffic to either the CPMCCM Ethernet port or any other logical port (for example LAG) on the device.

Management Access Filter Commands

When the source interface is configured, only management traffic arriving on those ports satisfy the match criteria.

The **no** form of the command reverts to the default value.

Default any interface

Parameters *port-id* — The port ID in the following format: slot[/mda]/port.

For example: To configure port 3 on MDA 2 on card 1 would be specified as 1/2/3.

Values	port-id	<i>slot/mda/port[.channel]</i>
	encap-val	0 for null 0 — 4094 for dot1q
	aps-id	<i>aps-group-id[.channel]</i>
	aps	keyword
	group-id	1 — 64ccag-idccag-id. <i>path-id[cc-type]</i> ccag keyword id 1 — 8 path-id a, b cc-type .sap-net, .net-sap cc-id 0 — 4094
	lag-id	<i>lag-id</i> lag keyword id 1 — 200
	cpm	keyword

cpm — Configure the Ethernet port on the primary to match the criteria.

src-ip

Syntax [**no**] **src-ip** {[*ip-prefix/mask*] | [*ip-prefix*] | **ip-prefix-list** *prefix-list-name*}

Context config>system>security>mgmt-access-filter>ip-filter>entry

Description This command configures a source IP address range prefix to be used as a management access filter match criterion.

The **no** form of the command removes the source IP address match criterion.

Default No source IP match criterion is specified.

Parameters *ip-prefix'mask* — The IP prefix for the IP match criterion in dotted decimal notation.

ip-prefix-list — Creates a list of IPv4 prefixes for match criteria in IPv4 ACL and CPM filter policies.

ip-prefix-list-name — A string of up to 32 characters of printable ASCII characters. If special characters are used, the string must be enclosed within double quotes.

mask — Specifies the subnet mask length expressed as a decimal integer.

Values 1 — 32 (mask length), 0.0.0.0 — 255.255.255.255 (dotted decimal)

src-ip

Syntax	[no] src-ip {[<i>ip-prefix/mask</i>] [<i>ip-prefix</i>] ip-prefix-list <i>prefix-list-name</i> }
Context	config>system>security>mgmt-access-filter>ipv6-filter>entry
Description	This command configures a source IPv6 address range prefix to be used as a management access filter match criterion. The no form of the command removes the source IPv6 address match criterion.
Default	No source IP match criterion is specified.
Parameters	<p><i>ip-prefix/mask</i> — The IP prefix for the IP match criterion in dotted decimal notation.</p> <p>ip-prefix-list — Creates a list of IPv4 prefixes for match criteria in IPv4 ACL and CPM filter policies.</p> <p><i>ipv6-prefix-list-name</i> — A string of up to 32 characters of printable ASCII characters. If special characters are used, the string must be enclosed within double quotes.</p> <p><i>mask</i> — Specifies the subnet mask length expressed as a decimal integer.</p> <p>Values 1 — 32 (mask length), 0.0.0.0 — 255.255.255.255 (dotted decimal)</p>

Password Commands

admin-password

Syntax	admin-password <i>password</i> [hash hash2] no admin-password
Context	config>system>security>password
Description	<p>This command allows a user (with admin permissions) to configure a password which enables a user to become an administrator.</p> <p>This password is valid only for one session. When enabled, no authorization to TACACS+ or RADIUS is performed and the user is locally regarded as an admin user.</p> <p>This functionality can be enabled in two contexts:</p> <pre>config>system>security>password>admin-password <global> enable-admin</pre> <p>NOTE: See the description for the enable-admin on the next page. If the admin-password is configured in the config>system>security>password context, then any user can enter the special mode by entering the enable-admin command.</p> <p>enable-admin is in the default profile. By default, all users are given access to this command.</p> <p>Once the enable-admin command is entered, the user is prompted for a password. If the password matches, user is given unrestricted access to all the commands.</p> <p>The minimum length of the password is determined by the minimum-length command. The complexity requirements for the password is determined by the complexity command.</p> <p>NOTE: The <i>password</i> argument of this command is not sent to the servers. This is consistent with other commands which configure secrets.</p> <p>Also note that usernames and passwords in the FTP and TFTP URLs will not be sent to the authorization or accounting servers when the file>copy source-url dest-url command is executed.</p> <p>For example:</p> <pre>file copy ftp://test:secret@131.12.31.79/test/srcfile cf1:\destfile</pre> <p>In this example, the username 'test' and password 'secret' will not be sent to the AAA servers (or to any logs). They will be replaced with '****'.</p> <p>The no form of the command removes the admin password from the configuration.</p>
Default	no admin-password
Parameters	<p><i>password</i> — Configures the password which enables a user to become a system administrator. The maximum length can be up to 20 characters if unhashed, 32 characters if hashed, 54 characters if the hash2 keyword is specified.</p> <p>hash — Specifies the key is entered in an encrypted form. If the hash parameter is not used, the key is assumed to be in a non-encrypted, clear text form. For security, all keys are stored in encrypted</p>

hash2 — Specifies the key is entered in a more complex encrypted form. If the **hash2** parameter is not used, the less encrypted **hash** form is assumed.

enable-admin

- Syntax** **enable-admin**
- Context** <global>
- Description** **NOTE:** See the description for the **admin-password** on the previous page. If the **admin-password** is configured in the `config>system>security>password` context, then any user can enter the special administrative mode by entering the **enable-admin** command.
- enable-admin** is in the default profile. By default, all users are given access to this command.
- Once the **enable-admin** command is entered, the user is prompted for a password. If the password matches, user is given unrestricted access to all the commands.
- The minimum length of the password is determined by the **minimum-length** command. The complexity requirements for the password is determined by the **complexity** command.
- There are two ways to verify that a user is in the enable-admin mode:
- `show users` — Administrator can know which users are in this mode.
 - Enter the `enable-admin` command again at the root prompt and an error message will be returned.

```
A:ALA-1# show users
=====
User Type From Login time Idle time
=====
admin Console -- 10AUG2006 13:55:24 0d 19:42:22
admin Telnet 10.20.30.93 09AUG2006 08:35:23 0d 00:00:00 A
-----
Number of users : 2
'A' indicates user is in admin mode
=====
A:ALA-1#
A:ALA-1# enable-admin
MINOR: CLI Already in admin mode.
A:ALA-1#
```

aging

- Syntax** **aging** *days*
no aging
- Context** `config>system>security>password`

Password Commands

Description	This command configures the number of days a user password is valid before the user must change their password. This parameter can be used to force the user to change the password at the configured interval. The no form of the command reverts to the default value.
Default	No aging is enforced.
Parameters	<i>days</i> — The maximum number of days the password is valid. Values 1 — 500

attempts

Syntax	attempts <i>count</i> [time <i>minutes1</i> [lockout <i>minutes2</i>]] no attempts
Context	config>system>security>password
Description	This command configures a threshold value of unsuccessful login attempts allowed in a specified time frame. If the threshold is exceeded, the user is locked out for a specified time period. If multiple attempts commands are entered, each command overwrites the previously entered command. The no attempts command resets all values to default.
Default	count: 3 time <i>minutes: 5</i> lockout <i>minutes: 10</i>
Parameters	<i>count</i> — The number of unsuccessful login attempts allowed for the specified time . This is a mandatory value that must be explicitly entered. Values 1 — 64 time <i>minutes</i> — The period of time, in minutes, that a specified number of unsuccessful attempts can be made before the user is locked out. Values 0 — 60 lockout <i>minutes</i> — The lockout period in minutes where the user is not allowed to login. Allowed values are decimal integers. Values 0 — 1440 infinite When the user exceeds the attempted count times in the specified time, then that user is locked out from any further login attempts for the configured time period. Default 10 Values 0 — 1440 Values infinite; user is locked out and must wait until manually unlocked before any further attempts.

authentication-order

Syntax	authentication-order [<i>method-1</i>] [<i>method-2</i>] [<i>method-3</i>] [exit-on-reject] no authentication-order
Context	config>system>security>password
Description	<p>This command configures the sequence in which password authentication, authorization, and accounting is attempted among RADIUS, TACACS+, and local passwords.</p> <p>The order should be from the most preferred authentication method to the least preferred. The presence of all methods in the command line does not guarantee that they are all operational. Specifying options that are not available delays user authentication.</p> <p>If all (operational) methods are attempted and no authentication for a particular login has been granted, then an entry in the security log register the failed attempt. Both the attempted login identification and originating IP address is logged with the a timestamp.</p> <p>The no form of the command reverts to the default authentication sequence.</p>
Default	authentication-order radius tacplus local - The preferred order for password authentication is 1. RADIUS, 2. TACACS+ and 3. local passwords.
Parameters	<p><i>method-1</i> — The first password authentication method to attempt.</p> <p>Default radius</p> <p>Values radius, tacplus, local</p> <p><i>method-2</i> — The second password authentication method to attempt.</p> <p>Default tacplus</p> <p>Values radius, tacplus, local</p> <p><i>method-3</i> — The third password authentication method to attempt.</p> <p>Default local</p> <p>Values radius, tacplus, local</p> <p>radius — RADIUS authentication.</p> <p>tacplus — TACACS+ authentication.</p> <p>local — Password authentication based on the local password database.</p> <p>exit-on-reject — When enabled and if one of the AAA methods configured in the authentication order sends a reject, then the next method in the order will not be tried. If the exit-on-reject keyword is not specified and if one AAA method sends a reject, the next AAA method will be attempted. If in this process, all the AAA methods are exhausted, it will be considered as a reject.</p> <p>Note that a rejection is distinct from an unreachable authentication server. When the exit-on-reject keyword is specified, authorization and accounting will only use the method that provided an affirmation authentication; only if that method is no longer readable or is removed from the configuration will other configured methods be attempted. If the local keyword is the first authentication and:</p>

Password Commands

- **exit-on-reject** is configured and the user does not exist, the user will not be authenticated.
- The user is authenticated locally, then other methods, if configured, will be used for authorization and accounting.
- The user is configured locally but without console access, login will be denied.

complexity-rules

Syntax	complexity-rules
Context	config>system>security>password
Description	This defines a list of rules for configurable password options.

allow-user-name

Syntax	[no] allow-user-name
Context	config>system>security>password>complexity-rules
Description	The user name is allowed to be used as part of the password. The no form of the command does not allow user name to be used as password

credits

Syntax	credits [lowercase <i>credits</i>] [uppercase <i>credits</i>] [numeric <i>credits</i>] [special-character <i>credits</i>] no credits
Context	config>system>security>password>complexity-rules
Description	The maximum credits given for usage of the different character classes in the local passwords. The no form of the command resets to default.
Default	no credits
Parameters	<i>credits</i> — The number of credits that can be used for each characters class. Values 0-10

minimum-classes

Syntax	minimum-classes <i>minimum</i> no minimum-classes
---------------	--

Context	config>system>security>password>complexity-rules
Description	Force the use of at least this many different character classes The no form of the command resets to default.
Default	no minimum-classes
Parameters	<i>minimum</i> — The minimum number of classes to be configured.
Values	2-4

minimum-length

Syntax	minimum-length <i>length</i> no minimum-length
Context	config>system>security>password
Description	This command configures the minimum number of characters required for locally administered passwords, HMAC-MD5-96, HMAC-SHA-96, and des-keys configured in the system security section. If multiple minimum-length commands are entered each command overwrites the previous entered command. The no form of the command reverts to default value.
Default	minimum-length 6
Parameters	<i>value</i> — The minimum number of characters required for a password.
Values	1 — 8

repeated-characters

Syntax	repeated-characters <i>count</i> no repeated-characters
Context	config>system>security>password>complexity-rules
Description	The number of times a characters can be repeated consecutively. The no form of the command resets to default.
Default	no repeated-characters
Parameters	<i>count</i> — The minimum count of consecutively repeated characters.
Values	2-8

required

Syntax	required [lowercase <i>count</i>] [uppercase <i>count</i>] [numeric <i>count</i>] [special-character <i>count</i>] no required
Context	config>system>security>password>complexity-rules
Description	Force the minimum number of different character classes required. The no form of the command resets to default.
Default	no required
Parameters	<i>count</i> — The minimum count of characters classes. Values 0-10

dynsvc-password

Syntax	dynsvc-password <i>password</i> [hash hash2] no dynsvc-password
Context	config>system>security>password
Description	Configure the password which enables the user to configure dynamic services.
Default	no dynsvc-password
Parameters	<i>password</i> — Configures the password which enables a user to become a system administrator. The maximum length can be up to 20 characters if unhashed, 32 characters if hashed, 54 characters if the hash2 keyword is specified. hash — Specifies the key is entered in an encrypted form. If the hash parameter is not used, the key is assumed to be in a non-encrypted, clear text form. For security, all keys are stored in encrypted hash2 — Specifies the key is entered in a more complex encrypted form. If the hash2 parameter is not used, the less encrypted hash form is assumed.

enable-admin-control

Syntax	enable-admin-control
Context	config>system>security>password
Description	Enable the user to become a system administrator.

tacplus-map-to-priv-lvl

Syntax	tacplus-map-to-priv-lvl [<i>admin-priv-lvl</i>]
---------------	--

no tacplus-map-to-priv-lvl

Context config>system>security>password>enable-admin-control

Description When **tacplus-map-to-priv-lvl** is enabled, and tacplus authorization is enabled with the *use-priv-lvl* option, typing **enable-admin** starts an interactive authentication exchange from the SR OS node to the TACACS+ server. The start message (service=enable) contains the user-id and the requested admin-priv-lvl. Successful authentication results in the use of a new profile (as configured under **config>system>security>tacplus>priv-lvl-map**).

health-check

Syntax [no] health-check [interval *interval*]

Context config>system>security>password

Description This command specifies that RADIUS and TACACS+ servers are monitored for 3 seconds each at 30 second intervals. Servers that are not configured will have 3 seconds of idle time. If in this process a server is found to be unreachable, or a previously unreachable server starts responding, based on the type of the server, a trap will be sent.

The **no** form of the command disables the periodic monitoring of the RADIUS and TACACS+ servers. In this case, the operational status for the active server will be up if the last access was successful.

Default health-check 30

Parameters **interval** *interval* — Specifies the polling interval for RADIUS servers.

Values 6 — 1500

history

Syntax **history** *size*
no history

Context config>system>security>password

Description Configure how many previous passwords a new password is matched against.

Default no history

Parameters **size** — Specifies how many previous passwords a new password is matched against.

Values 1—20

minimum-age

Password Commands

Syntax	minimum-age [days <i>days</i>] [hrs <i>hours</i>] [min <i>minutes</i>] [sec <i>seconds</i>] no minimum-age
Context	config>system>security>password
Description	Configure the minimum required age of a password before it can be changed again.
Default	no minimum-age
Parameters	<i>days</i> — Specifies the minimum required days of a password before it can be changed again. Values 0—1 <i>hours</i> — Specifies the minimum required hours of a password before it can be changed again. Values 0—23 <i>minutes</i> — Specifies the minimum required minutes of a password before it can be changed again. Values 0—59 <i>seconds</i> — Specifies the minimum required seconds of a password before it can be changed again. Values 0—59

minimum-change

Syntax	minimum-change <i>length</i> no minimum-change
Context	config>system>security>password
Description	This command configures the minimum number of characters required to be different in the new password from a previous password. The no form of the command reverts to default value.
Default	no min-change
Parameters	<i>length</i> — Specifies how many characters must be different in the new password from the old password. Values 2—20

password

Syntax	password
Context	config>system>security
Description	This command creates the context to configure password management parameters.

Public Key Infrastructure (PKI) Commands

pki

Syntax	pki
Context	config>system>security
Description	This command enables the context to configure certificate parameters.
Default	none

ca-profile

Syntax	ca-profile <i>name</i> [create] no ca-profile <i>name</i>
Context	config>system>security>pki
Description	<p>This command creates a new ca-profile or enter the configuration context of an existing ca-profile. Up to 128 ca-profiles could be created in the system. A shutdown the ca-profile will not affect the current up and running ipsec-tunnel or ipsec-gw that associated with the ca-profile. But authentication afterwards will fail with a shutdown ca-profile.</p> <p>Executing a no shutdown command in this context will cause system to reload the configured cert-file and crl-file.</p> <p>A ca-profile can be applied under the ipsec-tunnel or ipsec-gw configuration.</p> <p>The no form of the command removes the name parameter from the configuration. A ca-profile can not be removed until all the association(ipsec-tunnel/gw) have been removed.</p>
Parameters	<p><i>name</i> — Specifies the name of the ca-profile, a string up to 32 characters.</p> <p>create — Keyword used to create a new ca-profile. The create keyword requirement can be enabled/disabled in the environment>create context.</p>

cert-file

Syntax	cert-file <i>filename</i> no cert-file
Context	config>system>security>pki>ca-profile
Description	Specifies the filename of a file in cf3:\system-pki\cert as the CA's certificate of the ca-profile.
	Notes:

- The system will perform following checks against configured cert-file when a **no shutdown** command is issued:
 - Configured cert-file must be a DER formatted X.509v3 certificate file.
 - All non-optional fields defined in section 4.1 of RFC5280 must exist and conform to the RFC 5280 defined format.
 - Check the version field to see if its value is 0x2.
 - Check The Validity field to see that if the certificate is still in validity period.
 - X509 basic constraints extension must exists, and CA Boolean must be True.
 - If Key Usage extension exists, then at least keyCertSign and cRLSign should be asserted.
 - If the certificate is not a self-signing certificate , then system will try to look for issuer's CA's certificate to verify if this certificate is signed by issuer's CA; but if there is no such CA-profile configured, then system will just proceed with a warning message.
 - If the certificate is not a self-signing certificate, then system will try to look for issuer's CA's CRL to verify that it has not been revoked; but if there is no such CA-profile configured or there is no such CRL, then system will just proceed with a warning message.
- If any of above checks fails, then the **no shutdown** command will fail.

- Changing or removing of **cert-file** is only allowed when the **ca-profile** is in a **shutdown** state.

The **no** form of the command removes the filename from the configuration.

Parameters *filename* — Specifies a local CF card file URL.

accept-unprotected-errormsg

Syntax	[no] accept-unprotected-errormsg
Context	config>system>security>pkc>ca-profile>cmpv2
Description	This command enables the system to accept both protected and unprotected CMPv2 error message. Without this command, system will only accept protected error messages. The no form of the command causes the system to only accept protected PKI confirmation message.
Default	no

accept-unprotected-pkiconf

Syntax	[no] accept-unprotected-pkiconf
Context	config>system>security>pkc>ca-profile>cmpv2
Description	This command enables the system to accept both protected and unprotected CMPv2 PKI confirmation messages. Without this command, system will only accept protected PKI confirmation message. The no form of the command causes the system to only accept protected PKI confirmation message.

Default none

key-list

Syntax **cmp-key-list**

Context config>system>security>pki>ca-profile>cmp2

Description This command enables the context to configure pre-shared key list parameters.

key

Syntax **key** *password* [**hash**|**hash2**] **reference** *reference-number*
no key **reference** *reference-number*

Context config>system>security>pki>ca-profile>cmp2>key-list

Description This command specifies a pre-shared key used for CMPv2 initial registration. Multiples of key commands are allowed to be configured under this context.

The password and reference-number is distributed by the CA via out-of-band means.

The configured password is stored in configuration file in an encrypted form by using SR OS hash2 algorithm.

The **no** form of the command removes the parameters from the configuration.

Default none

Parameters *password* — Specifies a printable ASCII string, up to 64 characters in length.

hash — Specifies that the given password is already hashed using hashing algorithm version 1. A semantic check is performed on the given password field to verify if it is a valid hash 1 key to store in the database.

hash2 — Specifies that the given password is already hashed using hashing algorithm version 2. A semantic check is performed on the given password field to verify if it is a valid hash 2 key to store in the database.

reference *reference-number* — Specifies a printable ASCII string, up to 64 characters in length.

url

Syntax **cmp-url** *url-string* [**service-id** *service-id*]
no cmp-url

Context config>system>security>pki>ca-profile>cmp2

Description This command specifies HTTP URL of the CMPv2 server. The URL must be unique across all configured ca-profiles.

Public Key Infrastructure (PKI) Commands

The URL will be resolved by the DNS server configured (if configured) in the corresponding router context.

If the *service-id* is 0 or omitted, then system will try to resolve the FQDN via DNS server configured in *bof.cfg*. After resolution, the system will connect to the address in management routing instance first, then base routing instance.

Note that if the service is VPRN, then the system only allows HTTP ports 80 and 8080.

Default none

Parameters *url-string* — Specifies the HTTP URL of the CMPv2 server up to 180 characters in length.
service-id *service-id* — Specifies the service instance that used to reach CMPv2 server.

Values service-id: 1..2147483647
base-router: 0

http-response-timeout

Syntax **http-response-timeout** *timeout*
no http-response-timeout

Context config>system>security>pki>ca-profile>cmp2

Description This command specifies the timeout value for HTTP response that is used by CMPv2.
The **no** form of the command reverts to the default.

Default 30 seconds

Parameters *timeout* — Specifies the HTTP response timeout in seconds.

Values 1 — 3600

response-signing-cert

Syntax **response-signing-cert** *filename*
no response-signing-cert

Context config>system>security>pki>ca-profile>cmp2

Description This command specifies a imported certificate that is used to verify the CMP response message if they are protected by signature. If this command is not configured, then CA's certificate will be used.

Default none

Parameters *filename* — Specifies the filename of the imported certificate.

same-recipnonce-for-pollreq

Syntax	[no] same-recipnonce-for-pollreq
Context	config>system>security>pki>ca-profile>cmp2
Description	This command enables the system to use same recipNonce as the last CMPv2 response for poll request.
Default	none

crl-file

Syntax	crl-file <i>filename</i> no crl-file
Context	config>system>security>pki>ca-profile
Description	This command specifies the name of a file in cf3:\system-pki\crl as the Certification Revoke List file of the ca-profile . Notes: <ul style="list-style-type: none"> • The system will perform following checks against configured crl-file when a no shutdown command is issued: <ul style="list-style-type: none"> → A valid cert-file of the ca-profile must be already configured. → Configured crl-file must be a DER formatted CRLv2 file. → All non-optional fields defined in section 5.1 of RFC5280 must exist and conform to the RFC5280 defined format. → Check the version field to see if its value is 0x1. → Delta CRL Indicator must NOT exists (delta CRL is not supported). → CRL's signature must be verified by using the cert-file of ca-profile. • Changing or removing the crl-file is only allowed when the ca-profile is in a shutdown state. The no form of the command removes the filename from the configuration.
Default	none
Parameters	<i>filename</i> — Specifies the name of CRL file stored in cf3:\system-pki\crl.

ocsp

Syntax	ocsp
Context	config>system>security>pki>ca-profile
Description	This command enables the context to configure OCSP parameters.

responder-url

Syntax	responder-url <i>url-string</i> no responder-url
Context	config>system>security>pki>ca-profile>ocsp
Description	This command specifies HTTP URL of the OCSP responder for the CA, this URL will only be used if there is no OCSP responder defined in the AIA extension of the certificate to be verified.
Default	no responder-url
Parameters	<i>url-string</i> — Specifies the HTTP URL of the OCSP responder

service

Syntax	service <i>service-id</i> no service
Context	config>system>security>pki>ca-profile>ocsp
Description	<p>This command specifies the service or routing instance that used to contact OCSP responder. This applies to OCSP responders that either configured in CLI or defined in AIA extension of the certificate to be verified.</p> <p>The responder-url will also be resolved by using the DNS server configured in the configured routing instance.</p> <p>In case of VPRN service, system will check if the specified service-id or service-name is an existing VPRN service at the time of CLI configuration. Otherwise the configuration will fail.</p>
Parameters	<i>service-id</i> — Specifies an existing service ID to be used in the match criteria.
Values	service-id: 1 — 2147483647 base-router: 0

maximum-cert-chain-depth

Syntax	maximum-cert-chain-depth <i>level</i> no maximum-cert-chain-depth
Context	config>system>security>pki
Description	<p>This command defines the maximum depth of certificate chain verification. This number is applied system wide.</p> <p>The no form of the command reverts to the default.</p>
Default	7

Parameters *level* — Specifies the maximum depth level of certificate chain verification, range from 1 to 7. the certificate under verification is not counted in. for example, if this parameter is set to 1, then the certificate under verification must be directly signed by trust anchor CA.

Values 1 — 7

shutdown

Syntax [no] shutdown

Context config>system>security>pki>ca-profile>

Description Use this command to enable or disable the ca-profile. The system will verify the configured cert-file and crl-file. If the verification fails, then the **no shutdown** command will fail.

The ca-profile in a **shutdown** state cannot be used in certificate authentication.

Default shutdown

certificate

Syntax certificate

Context admin

Description This command enables the context to configure X.509 certificate related operational parameters.

clear-ocsp-cache

Syntax clear-ocsp-cache [*entry-id*]

Context admin>certificate

Description This command clears the current OCSP response cache. If optional issuer and serial-number are not specified, then all current cached results are cleared.

Parameters *entry-id* — Specifies the local cache entry identifier of the certificate to clear.

Values 1 — 2000

display

Syntax display type {cert|key|crl|cert-request} *url-string* format {pkcs10|pkcs12|pkcs7-der|pkcs7-pem|pem|der} [password [32 chars max]]

Context admin>certificate

Public Key Infrastructure (PKI) Commands

Description This command displays the content of an input file in plain text. Note that when displaying the key file content, only the key size and type are displayed.

The following list summarizes the formats supported by this command:

- DefaultCertificate**
- system format
 - PKCS #12
 - PKCS #7 PEM encoded
 - PKCS #7 DER encoded
 - RFC4945
 - Certificate Request
 - PKCS #10
 - Key
 - system format
 - PKCS #12
 - CRL
 - system format
 - PKCS #7 PEM encoded
 - PKCS #7 DER encoded
 - RFC4945

Default none

Parameters *file-url* — Specifies the local CF card url of the input file.

Values	url-string	<local-url> - [99 chars max]
	local-url	<cflash-id>/<file-path>
	cflash-id	cf1: cf2: cf3:

type — Specifies the type of input file, possible values are cert/key/crl/cert-request.

Values cert, key, crl, cert-request

format — Specifies the format of input file.

Values pkcs10, pkcs12, pkcs7-der, pkcs7-pem, pem, der

password — Specifies the password to decrypt the input file in case that it is a encrypted PKCS#12 file, up to 99 characters in length.

export

Syntax **export type {cert|key|crl} input filename output url-string format output-format [password [32 chars max]] [pkey filename]**

Context admin>certificate

Description This command performs certificate operations.

gen-keypair

Syntax	gen-keypair <i>url-string</i> [size {512 1024 2048}] [type {rsa dsa}]		
Context	admin>certificate		
Description	This command generate a RSA or DSA private key/public key pairs and store them in a local file in cf3:\system-pki\key		
Parameters	<i>url-string</i> — Specifies the name of the key file.		
	Values	url-string	<local-url> - [99 chars max]
		local-url	<cf-flash-id>/<file-path>
		cf-flash-id	cf1: cf2: cf3:
	size — Specifies the key size in bits.		
	possible choice are 512/1024/2048; the default value is		
	Default	2048	
	type — Specifies the type of key.		
	Default	rsa	

gen-local-cert-req

Syntax	gen-local-cert-req keypair <i>url-string</i> subject-dn <i>subject-dn</i> [domain-name [255 chars max]] [ip-addr <i>ip-address</i>] file <i>url-string</i> [hash-alg <i>hash-algorithm</i>]		
Context	admin>certificate		
Description	This command generates a PKCS#10 formatted certificate request by using a local existing key pair file.		
Default	none		
Parameters	<i>url-string</i> — Specifies the name of the keyfile in cf3:\system-pki\key that is used to generate a certificate request.		
	Values	url-string	<local-url> - [99 chars max]
		local-url	<cf-flash-id>/<file-path>
		cf-flash-id	cf1: cf2: cf3:
	subject-dn — Specifies the distinguish name that is used as the subject in a certificate request, including:		
	<ul style="list-style-type: none"> • C-Country • ST-State • O-Organization name • OU-Organization Unit name • CN-common name 		

Public Key Infrastructure (PKI) Commands

This parameter is formatted as a text string including any of the above attributes. The attribute and its value is linked by using "=", and "," is used to separate different attributes.

For example: C=US,ST=CA,O=ALU,CN=SR12

Values attr1=val1,attr2=val2... where: attrN={C|ST|O|OU|CN}, 256 chars max

domain-name — Optionally, a domain name string can be specified and included as the dNSName in the Subject Alternative Name extension of the certificate request.

ip-address — Optionally, an IPv4 address string can be specified and included as the ipAddress in the Subject Alternative Name extension of the certificate request.

cert-req-file-url — This URL could be either a local CF card path and filename to save the certificate request; or an FTP URL to upload the certificate request.

hash-alg *hash-algorithm* — Specifies the hash algorithm to be used in a certificate request.

Values sha1, sha224, sha256, sha384, sha512

import

Syntax	import type {cert key crl} input url-string output filename format input-format [password [32 chars max]]
Context	admin>certificate#
Description	<p>This command converts an input file(key/certificate/CRL) to a system format file. The following list summarizes the formats supported by this command:</p> <ul style="list-style-type: none">• Certificate<ul style="list-style-type: none">→ PKCS #12→ PKCS #7 PEM encoded→ PKCS #7 DER encoded→ PEM→ DER• Key<ul style="list-style-type: none">→ PKCS #12→ PEM→ DER• CRL<ul style="list-style-type: none">→ PKCS #7 PEM encoded→ PKCS #7 DER encoded→ PEM→ DER

Note that if there are multiple objects with same type in the input file, only first object will be extracted and converted.

Default	none						
Parameters	<p>input <i>url-string</i> — Specifies the URL for the input file. This URL could be either a local CF card URL file or a FP URL to download the input file.</p> <p>output <i>url-string</i> — Specifies the name of output file up to 95 characters in length. The output directory depends on the file type like following:</p> <ul style="list-style-type: none"> • Key: cf3:\system-pki\key • Cert: cf3:\system-pki\cert • CRL: cf3:\system-pki\CRL <p>Values</p> <table> <tr> <td>url-string</td> <td><local-url> - [99 chars max]</td> </tr> <tr> <td>local-url</td> <td><cflash-id>/<file-path></td> </tr> <tr> <td>cflash-id</td> <td>cf1: cf2: cf3:</td> </tr> </table> <p>type — The type of input file.</p> <p>Values cert, key, crt</p> <p>format — Specifies the format of input file.</p> <p>Values pkcs12, pkcs7-der, pkcs7-pem, pem, der</p> <p>password — Specifies the password to decrypt the input file in case that it is a encrypted PKCS#12 file.</p>	url-string	<local-url> - [99 chars max]	local-url	<cflash-id>/<file-path>	cflash-id	cf1: cf2: cf3:
url-string	<local-url> - [99 chars max]						
local-url	<cflash-id>/<file-path>						
cflash-id	cf1: cf2: cf3:						

reload

Syntax	reload type {cert key} filename
Context	admin>certificate
Description	This command reloads the certificate/key file.
Parameters	<i>filename</i> — Specifies the file name up to 95 characters in length.

Profile Management Commands

action

Syntax	action {deny permit}
Context	config>system>security>profile <i>user-profile-name</i> >entry <i>entry-id</i>
Description	This command configures the action associated with the profile entry.
Parameters	deny — Specifies that commands matching the entry command match criteria are to be denied. permit — Specifies that commands matching the entry command match criteria will be permitted.

match

Syntax	match <i>command-string</i> no match
Context	config>system>security>profile <i>user-profile-name</i> >entry <i>entry-id</i>
Description	This command configures a command or subtree commands in subordinate command levels are specified. Because the OS exits when the first match is found, subordinate levels cannot be modified with subsequent action commands. More specific action commands should be entered with a lower entry number or in a profile that is evaluated prior to this profile. All commands below the hierarchy level of the matched command are denied. The no form of this command removes a match condition
Default	none
Parameters	<i>command-string</i> — The CLI command or CLI tree level that is the scope of the profile entry.

copy

Syntax	copy { user <i>source-user</i> profile <i>source-profile</i> } to <i>destination</i> [overwrite]
Context	config>system>security
Description	This command copies a profile or user from a source profile to a destination profile.
Parameters	<i>source-profile</i> — The profile to copy. The profile must exist. <i>dest-profile</i> — The copied profile is copied to the destination profile.

overwrite — Specifies that the destination profile configuration will be overwritten with the copied source profile configuration. A profile will not be overwritten if the **overwrite** command is not specified.

default-action

Syntax	default-action { deny-all permit-all none }
Context	config>system>security>profile <i>user-profile-name</i>
Description	This command specifies the default action to be applied when no match conditions are met.
Default	none
Parameters	<p>deny-all — Sets the default of the profile to deny access to all commands.</p> <p>permit-all — Sets the default of the profile to permit access to all commands.</p> <p>Note: permit-all does not change access to security commands. Security commands are only and always available to members of the super-user profile.</p> <p>none — Sets the default of the profile to no-action. This option is useful to assign multiple profiles to a user.</p> <p>For example, if a user is a member of two profiles and the default action of the first profile is permit-all, then the second profile will never be evaluated because the permit-all is executed first. Set the first profile default action to none and if no match conditions are met in the first profile, then the second profile will be evaluated. If the default action of the last profile is none and no explicit match is found, then the default deny-all takes effect.</p>

description

Syntax	description <i>description-string</i> no description
Context	config>system>security>profile <i>user-profile-name</i> >entry <i>entry-id</i>
Description	<p>This command creates a text description stored in the configuration file for a configuration context.</p> <p>The description command associates a text string with a configuration context to help identify the context in the configuration file.</p> <p>The no form of the command removes the string from the context.</p>
Default	No description is configured.
Parameters	<i>string</i> — The description character string. Allowed values are any string up to 80 characters long composed of printable, 7-bit ASCII characters. If the string contains special characters (#, \$, spaces, etc.), the entire string must be enclosed within double quotes.

entry

Syntax	[no] entry <i>entry-id</i>
Context	config>system>security>profile <i>user-profile-name</i>
Description	<p>This command is used to create a user profile entry.</p> <p>More than one entry can be created with unique <i>entry-id</i> numbers. Exits when the first match is found and executes the actions according to the accompanying action command. Entries should be sequenced from most explicit to least explicit.</p> <p>An entry may not have any match criteria defined (in which case, everything matches) but must have at least the keyword action for it to be considered complete.</p> <p>The no form of the command removes the specified entry from the user profile.</p>
Default	No entry IDs are defined.
Parameters	<p><i>entry-id</i> — An entry-id uniquely identifies a user profile command match criteria and a corresponding action. If more than one entry is configured, the <i>entry-ids</i> should be numbered in staggered increments to allow users to insert a new entry without requiring renumbering of the existing entries.</p> <p>Values 1 — 9999</p>

profile

Syntax	[no] profile <i>user-profile-name</i>
Context	config>system>security
Description	<p>This command creates a context to create user profiles for CLI command tree permissions.</p> <p>Profiles are used to either deny or permit user console access to a hierarchical branch or to specific commands.</p> <p>Once the profiles are created, the user command assigns users to one or more profiles. You can define up to 16 user profiles but a maximum of 8 profiles can be assigned to a user. The <i>user-profile-name</i> can consist of up to 32 alphanumeric characters.</p> <p>The no form of the command deletes a user profile.</p>
Default	user-profile default
Parameters	<p><i>user-profile-name</i> — The user profile name entered as a character string. The string is case sensitive and limited to 32 ASCII 7-bit printable characters with no spaces.</p>

renum

- Syntax** `renum old-entry-number new-entry-number`
- Context** `config>system>security>profile user-profile-name`
- Description** This command renumbers profile entries to re-sequence the entries.
Since the OS exits when the first match is found and executes the actions according to accompanying action command, re-numbering is useful to rearrange the entries from most explicit to least explicit.
- Parameters** *old-entry-number* — Enter the entry number of an existing entry.
Values 1 — 9999
new-entry-number — Enter the new entry number.
Values 1 — 9999

User Management Commands

access

Syntax	[no] access [ftp] [snmp] [console] [li]
Context	config>system>security>user config>system>security>user-template
Description	<p>This command grants a user permission for FTP, SNMP, console or lawful intercept (LI) access.</p> <p>If a user requires access to more than one application, then multiple applications can be specified in a single command. Multiple commands are treated additively.</p> <p>The no form of command removes access for a specific application.</p> <p>no access denies permission for all management access methods. To deny a single access method, enter the no form of the command followed by the method to be denied, for example, no access FTP denies FTP access.</p>
Default	No access is granted to the user by default.
Parameters	<p>ftp — Specifies FTP permission.</p> <p>snmp — Specifies SNMP permission. This keyword is only configurable in the config>system>security>user context.</p> <p>console — Specifies console access (serial port or Telnet) permission.</p> <p>li — Allows user to access CLI commands in the lawful intercept (LI) context.</p>

authentication

Syntax	authentication {[none] [[hash] {md5 key-1 sha key-1} privacy {none des-key aes-128-cfb-key key-2}]}
Context	config>system>security>user>snmp
Description	<p>This command configures the authentication and encryption method the user must use in order to be validated by the router. SNMP authentication allows the device to validate the managing node that issued the SNMP message and determine if the message has been tampered.</p> <p>The keys configured in this command must be localized keys (MD5 or DES hash of the configured SNMP engine-ID and a password). The password is not directly entered in this command (only the localized key).</p>
Default	authentication none - No authentication is configured and privacy cannot be configured.
Parameters	none — Do not use authentication. If none is specified, then privacy cannot be configured.

hash — When **hash** is not specified, then non-encrypted characters can be entered. When **hash** is configured, then all specified keys are stored in an encrypted format in the configuration file. The password must be entered in encrypted form when the **hash** parameter is used.

md5 key — The authentication protocol can either be HMAC-MD5-96 or HMAC-SHA-96.

The MD5 authentication key is stored in an encrypted format. The minimum key length is determined by the **config>system>security>password>minimum-length** value. The maximum length is 16 octets (32 printable characters).

The complexity of the key is determined by the **complexity-rules** command.

sha key — The authentication protocol can be either HMAC-MD5-96 or HMAC-SHA-96.

The **sha** authentication key is stored in an encrypted format. The minimum key length is determined by the **config>system>security>password>minimum-length** value. The maximum length is 20 octets (40 printable characters).

The complexity of the key is determined by the **complexity-rules** command.

privacy none — Do not perform SNMP packet encryption.

Default privacy none

privacy des-key key-2 — Use DES for SNMP payload encryption and configure the key. The key must be a 32 hex-character string and is stored in an encrypted format.

privacy aes-128-cfb-key key-2 — Use 128 bit CFB mode AES for SNMP payload encryption and configure the key. The key must be a 32 hex-character string and is stored in an encrypted format.

Default privacy none

group

Syntax	group <i>group-name</i> no group
Context	config>system>security>user>snmp
Description	This command associates (or links) a user to a group name. The group name must be configured with the config>system>security>user >snmp>group command. The access command links the group with one or more views, security model (s), security level (s), and read, write, and notify permissions
Default	No group name is associated with a user.
Parameters	<i>group-name</i> — Enter the group name (between 1 and 32 alphanumeric characters) that is associated with this user. A user can be associated with one group-name per security model.

cannot-change-password

Syntax	[no] cannot-change-password
Context	config>system>security>user>console
Description	<p>This command allows a user the privilege to change their password for both FTP and console login. To disable a user's privilege to change their password, use the cannot-change-password form of the command.</p> <p>Note that the cannot-change-password flag is not replicated when a user copy is performed. A new-password-at-login flag is created instead.</p>
Default	no cannot-change-password

console

Syntax	console
Context	config>system>security>user config>system>security>user-template
Description	This command creates the context to configure user profile membership for the console (either Telnet or CPM serial port user).

copy

Syntax	copy {user <i>source-user</i> profile <i>source-profile</i>} to <i>destination</i> [overwrite]
Context	config>system>security
Description	<p>This command copies a specific user's configuration parameters to another (destination) user. The password is set to a carriage return and a new password at login must be selected.</p>
Parameters	<p><i>source-user</i> — The user to copy. The user must already exist.</p> <p><i>dest-user</i> — The copied profile is copied to a destination user.</p> <p>overwrite — Specifies that the destination user configuration will be overwritten with the copied source user configuration. A configuration will not be overwritten if the overwrite command is not specified.</p>

home-directory

Syntax	home-directory <i>url-prefix</i> [<i>directory</i>] [<i>directory/directory...</i>] no home-directory
Context	config>system>security>user

```
config>system>security>user-template
```

- Description** This command configures the local home directory for the user for both console (file commands and '>' redirection) and FTP access.
- If the URL or the specified URL/directory structure is not present, then a warning message is issued and the default is assumed.
- The **no** form of the command removes the configured home directory.
- Default** no home-directory
- NOTE: If restrict-to-home has been configured no file access is granted and no home-directory is created, if restrict-to-home is not applied then root becomes the user's home-directory.
- Parameters** *local-url-prefix* [*directory*] [*directory/directory...*] — The user's local home directory URL prefix and directory structure up to 190 characters in length.

profile

- Syntax** **profile** *user-profile-name*
no profile
- Context** config>system>security>user-template
- Description** This command configures the profile for the user based on this template.
- Parameters** *user-profile-name* — The user profile name entered as a character string. The string is case sensitive and limited to 32 ASCII 7-bit printable characters with no spaces.

login-exec

- Syntax** [**no**] **login-exec** *url-prefix: source-url*
- Context** config>system>security>user>console
config>system>security>user-template>console
- Description** This command configures a user's login exec file which executes whenever the user successfully logs in to a console session.
- Only one exec file can be configured. If multiple **login-exec** commands are entered for the same user, each subsequent entry overwrites the previous entry.
- The **no** form of the command disables the login exec file for the user.
- Default** No login exec file is defined.
- Parameters** *url-prefix: source-url* — Enter either a local or remote URL, up to 200 characters in length, that identifies the exec file that will be executed after the user successfully logs in.

member

Syntax	member <i>user-profile-name</i> [<i>user-profile-name...</i>] no member <i>user-profile-name</i>
Context	config>system>security>user>console
Description	This command is used to allow the user access to a profile. A user can participate in up to eight profiles. The no form of this command deletes access user access to a profile.
Default	default
Parameters	<i>user-profile-name</i> — The user profile name.

new-password-at-login

Syntax	[no] new-password-at-login
Context	config>system>security>user>console
Description	This command forces the user to change a password at the next console login. The new password applies to FTP but the change can be enforced only by the console, SSH, or Telnet login. The no form of the command does not force the user to change passwords.
Default	no new-password-at-login

password

Syntax	password [<i>password</i>] [hash hash2]
Context	config>system>security>user
Description	This command configures the user password for console and FTP access. The use of the hash keyword sets the initial password when the user is created or modifies the password of an existing user and specifies that the given password was hashed using hashing algorithm version 1. The password is stored in an encrypted format in the configuration file when specified. Passwords should be encased in double quotes (“ ”) at the time of the password creation. The double quote character (“”) is not accepted inside a password. It is interpreted as the start or stop delimiter of a string. The use of the hash2 keyword specifies that the given password is already hashed using hashing algorithm version 2. A semantic check is performed on the given password field to verify if it is a valid hash 2 key to store in the database. In previous releases, the password command syntax included the hash (hash version 1) parameter that allowed you to specify a password and encryption. For example,

```
config>system>security>user# password testuser1
```

The password was hashed by default.

For example:

```
config>system>security# user testuser1
config>system>security>user$ password xyzabcd1
config>system>security>user# exit
```

```
config>system>security# info
-----
...
        user "testuser1"
            password "I/VhQSk/FWY" hash
        exit
...
-----
config>system>security#
```

In the current release, the **password** command allows you also to specify a different hashing scheme, hash version 2.

For example,

```
config>system>security# user testuser1
config>system>security>user$ password "zx/Uhcn6ReMOZ3BvrWcvk." hash2
config>system>security>user# exit
```

```
config>system>security# info
-----
...
        user "testuser1"
            password "zx/Uhcn6ReMOZ3BvrWcvk." hash2
        exit
...
-----
config>system>security#
```

Parameters

password — This is the password for the user that must be entered by this user during the login procedure. The minimum length of the password is determined by the **minimum-length** command. The maximum length can be up to 20 chars if unhashed, 32 characters if hashed. The complexity requirements for the password is determined by the **complexity** command.

All password special characters (#, \$, spaces, etc.) must be enclosed within double quotes.

For example: config>system>security>user# password "south#bay?"

The question mark character (?) cannot be directly inserted as input during a telnet connection because the character is bound to the **help** command during a normal Telnet/console connection.

To insert a # or ? characters, they must be entered inside a notepad or clipboard program and then cut and pasted into the Telnet session in the password field that is encased in the double quotes as delimiters for the password.

If a password is entered without any parameters, a password length of zero is implied: (carriage return).

User Management Commands

hash — Specifies that the given password is already hashed using hashing algorithm version 1. A semantic check is performed on the given password field to verify if it is a valid hash 1 key to store in the database.

hash2 — Specifies that the given password is already hashed using hashing algorithm version 2. A semantic check is performed on the given password field to verify if it is a valid hash 2 key to store in the database.

restricted-to-home

Syntax	[no] restricted-to-home
Context	config>system>security>user config>system>security>user-template
Description	<p>This command prevents users from navigating above their home directories for file access (either by means of CLI sessions with the file command, '>' redirection, or by means of FTP). A user is not allowed to navigate to a directory higher in the directory tree on the home directory device. The user is allowed to create and access subdirectories below their home directory.</p> <p>If a home-directory is not configured or the home directory is not available, then the user has no file access.</p> <p>The no form of the command allows the user access to navigate to directories above their home directory.</p>
Default	no restricted-to-home

rsa-key

Syntax	[no] rsa-key <i>"public-key-name"</i> <i>key-id</i>
Context	config>system>security>user
Description	<p>This command allows the user to associate an RSA public key with the user-name. The public key must be enclosed in quotation marks. This command may be used several times since a user may have multiple public keys. The key is a 1024-bit key.</p>
Default	none
Parameters	<i>public-key-name</i> — Specifies the public key, enclosed in quotation marks. The key is a 1024-bit key. <i>key-id</i> — Specifies the key identifier name.

snmp

Syntax	snmp
Context	config>system>security>user

- Description** This command creates the context to configure SNMP group membership for a specific user and defines encryption and authentication parameters.
- All SNMPv3 users must be configured with the commands available in this CLI node.
- The OS always uses the configured SNMPv3 user name as the security user name.

user-template

- Syntax** `user-template {tacplus_default | radius_default}`
- Context** `config>system>security`
- Description** This command configures default security user template parameters.
- Parameters** **tacplus_default** — Specifies that the default TACACS+ user template is actively applied to the TACACS+ user.
- radius_default** — specifies that the default RADIUS user template is actively applied to the RADIUS user if no VSAs are returned with the auth-accept from the RADIUS server.

user

- Syntax** `[no] user user-name`
- Context** `config>system>security`
- Description** This command creates a local user and a context to edit the user configuration.
- If a new *user-name* is entered, the user is created. When an existing *user-name* is specified, the user parameters can be edited.
- When creating a new user and then entering the **info** command, the system displays a password in the output. This is expected behavior in the hash2 scenario. However, when using that user name, there will be no password required. The user can login to the system and then <ENTER> at the password prompt, the user will be logged in.
- Unless an administrator explicitly changes the password, it will be null. The hashed value displayed uses the username and null password field, so when the username is changed, the displayed hashed value will change.
- The **no** form of the command deletes the user and all configuration data. Users cannot delete themselves.
- Default** none
- Parameters** *user-name* — The name of the user up to 32 characters.

RADIUS Client Commands

access-algorithm

Syntax	access-algorithm { direct round-robin } no access-algorithm
Context	config>system>security>radius
Description	This command indicates the algorithm used to access the set of RADIUS servers.
Default	direct
Parameters	direct — The first server will be used as primary server for all requests, the second as secondary and so on. round-robin — The first server will be used as primary server for the first request, the second server as primary for the second request, and so on. If the router gets to the end of the list, it starts again with the first server.

accounting

Syntax	[no] accounting
Context	config>system>security>radius
Description	This command enables RADIUS accounting. The no form of this command disables RADIUS accounting.
Default	no accounting

accounting-port

Syntax	accounting-port <i>port</i> no accounting-port
Context	config>system>security>radius
Description	This command specifies a UDP port number on which to contact the RADIUS server for accounting requests.
Parameters	<i>port</i> — Specifies the UDP port number. Values 1 — 65535 Default 1813

authorization

Syntax	[no] authorization
Context	config>system>security>radius
Description	This command configures RADIUS authorization parameters for the system.
Default	no authorization

port

Syntax	port <i>port</i> no port
Context	config>system>security>radius
Description	This command configures the TCP port number to contact the RADIUS server. The no form of the command reverts to the default value.
Default	1812 (as specified in RFC 2865, <i>Remote Authentication Dial In User Service (RADIUS)</i>)
Parameters	<i>port</i> — The TCP port number to contact the RADIUS server. Values 1 — 65535

radius

Syntax	[no] radius
Context	config>system>security
Description	This command creates the context to configure RADIUS authentication on the router. Implement redundancy by configuring multiple server addresses for each router. The no form of the command removes the RADIUS configuration.

retry

Syntax	retry <i>count</i> no retry
Context	config>system>security>radius config>system>security>dot1x>radius-plcy
Description	This command configures the number of times the router attempts to contact the RADIUS server for authentication if there are problems communicating with the server.

The **no** form of the command reverts to the default value.

Default 3

Parameters *count* — The retry count.

Values 1 — 10

priv-lvl-map

Syntax [**no**] **priv-lvl-map**

Context config>system>security>tacplus

Description This command is used to specify a series of mappings between TACACS+ *priv-lvl* and locally configured profiles for authorization. These mappings are used when the *use-priv-lvl* option is specified for tacplus authorization.

priv-lvl

Syntax **priv-lvl** *priv-lvl user-profile-name*
no priv-lvl *priv-lvl*

Context config>system>security>tacplus>priv-lvl-map

Description This command maps a specific TACACS+ *priv-lvl* to a locally configured profile for authorization. This mapping is used when the **use-priv-lvl** option is specified for TACPLUS authorization.

Parameters *priv-lvl* — Specifies the privilege level used when sending a TACACS+ ENABLE request.

Values 0 — 15

user-profile-name — Specifies the user profile for this mapping.

server

Syntax **server** *index address ip-address secret key [hash | hash2]
no server *index**

Context config>system>security>radius

Description This command adds a RADIUS server and configures the RADIUS server IP address, index, and key values.

Up to five RADIUS servers can be configured at any one time. RADIUS servers are accessed in order from lowest to highest index for authentication requests until a response from a server is received. A higher indexed server is only queried if no response is received from a lower indexed server (which implies that the server is not available). If a response from a server is received, no other RADIUS

servers are queried. It is assumed that there are multiple identical servers configured as backups and that the servers do not have redundant data.

The **no** form of the command removes the server from the configuration.

Default No RADIUS servers are configured.

Parameters *index* — The index for the RADIUS server. The index determines the sequence in which the servers are queried for authentication requests. Servers are queried in order from lowest to highest index.

Values 1 — 5

address *ip-address* — The IP address of the RADIUS server. Two RADIUS servers cannot have the same IP address. An error message is generated if the server address is a duplicate.

Values

ipv4-address	a.b.c.d (host bits must be 0)
ipv6-address	x:x:x:x:x:x:x (eight 16-bit pieces)
	x:x:x:x:x:d.d.d.d
	x: [0..FFFF]H
	d: [0..255]D

secret *key* — The secret key to access the RADIUS server. This secret key must match the password on the RADIUS server.

Values Up to 128 characters in length.

hash — Specifies the key is entered in an encrypted form. If the **hash** parameter is not used, the key is assumed to be in a non-encrypted, clear text form. For security, all keys are stored in encrypted form in the configuration file with the **hash** parameter specified.

hash2 — Specifies the key is entered in a more complex encrypted form. If the **hash2** parameter is not used, the less encrypted **hash** form is assumed.

shutdown

Syntax **[no] shutdown**

Context config>system>security>radius

Description This command administratively disables the RADIUS protocol operation. Shutting down the protocol does not remove or change the configuration other than the administrative state.

The operational state of the entity is disabled as well as the operational state of any entities contained within. Many objects must be shut down before they may be deleted.

The **no** form of the command administratively enables the protocol which is the default state.

Default no shutdown

timeout

Syntax **timeout** *seconds*

no timeout

Context	config>system>security>radius
Description	This command configures the number of seconds the router waits for a response from a RADIUS server. The no form of the command reverts to the default value.
Default	3 seconds
Parameters	<i>seconds</i> — The number of seconds the router waits for a response from a RADIUS server, expressed as a decimal integer. Values 1 — 90

use-default-template

Syntax [no] use-default-template

Context config>system>security>radius

Description This command specifies whether the RADIUS user template is actively applied to the RADIUS user if no VSAs are returned with the auth-accept from the RADIUS server. When enabled, the RADIUS user template is actively applied if no VSAs are returned with the auth-accept from the RADIUS server.

The **no** form of the command disables the command.

TACACS+ Client Commands

server

Syntax	server <i>index</i> address <i>ip-address</i> secret <i>key</i> [port <i>port</i>] no server <i>index</i>						
Context	config>system>security>tacplus						
Description	This command adds a TACACS+ server and configures the TACACS+ server IP address, index, and key values. Up to five TACACS+ servers can be configured at any one time. TACACS+ servers are accessed in order from lowest index to the highest index for authentication requests. The no form of the command removes the server from the configuration.						
Default	No TACACS+ servers are configured.						
Parameters	<p><i>index</i> — The index for the TACACS+ server. The index determines the sequence in which the servers are queried for authentication requests. Servers are queried in order from the lowest index to the highest index.</p> <p>Values 1 — 5</p> <p>address <i>ip-address</i> — The IP address of the TACACS+ server. Two TACACS+ servers cannot have the same IP address. An error message is generated if the server address is a duplicate.</p> <table> <tr> <td>Values</td> <td>ipv4-address</td> <td>a.b.c.d (host bits must be 0)</td> </tr> <tr> <td></td> <td>ipv6-address</td> <td>x:x:x:x:x:x:x (eight 16-bit pieces) x:x:x:x:x:d.d.d.d x: [0..FFFF]H d: [0..255]D</td> </tr> </table> <p>secret <i>key</i> — The secret key to access the RADIUS server. This secret key must match the password on the RADIUS server.</p> <p>Values Up to 128 characters in length.</p> <p>hash — Specifies the key is entered in an encrypted form. If the hash parameter is not used, the key is assumed to be in a non-encrypted, clear text form. For security, all keys are stored in encrypted form in the configuration file with the hash parameter specified.</p> <p>hash2 — Specifies the key is entered in a more complex encrypted form. If the hash2 parameter is not used, the less encrypted hash form is assumed.</p> <p>port <i>port</i> — Specifies the port ID.</p> <p>Values 0 — 65535</p>	Values	ipv4-address	a.b.c.d (host bits must be 0)		ipv6-address	x:x:x:x:x:x:x (eight 16-bit pieces) x:x:x:x:x:d.d.d.d x: [0..FFFF]H d: [0..255]D
Values	ipv4-address	a.b.c.d (host bits must be 0)					
	ipv6-address	x:x:x:x:x:x:x (eight 16-bit pieces) x:x:x:x:x:d.d.d.d x: [0..FFFF]H d: [0..255]D					

shutdown

Syntax	[no] shutdown
Context	config>system>security>tacplus
Description	<p>This command administratively disables the TACACS+ protocol operation. Shutting down the protocol does not remove or change the configuration other than the administrative state.</p> <p>The operational state of the entity is disabled as well as the operational state of any entities contained within. Many objects must be shut down before they may be deleted.</p> <p>The no form of the command administratively enables the protocol which is the default state.</p>
Default	no shutdown

tacplus

Syntax	[no] tacplus
Context	config>system>security
Description	<p>This command creates the context to configure TACACS+ authentication on the router.</p> <p>Configure multiple server addresses for each router for redundancy.</p> <p>The no form of the command removes the TACACS+ configuration.</p>

accounting

Syntax	accounting [record-type {start-stop stop-only}] no accounting
Context	config>system>security>tacplus
Description	This command configures the type of accounting record packet that is to be sent to the TACACS+ server. The record-type parameter indicates whether TACACS+ accounting start and stop packets be sent or just stop packets be sent.
Default	record-type stop-only
Parameters	<p>record-type start-stop — Specifies that a TACACS+ start packet is sent whenever the user executes a command.</p> <p>record-type stop-only — Specifies that a stop packet is sent whenever the command execution is complete.</p>

authorization

Syntax	[no] authorization [use-priv-lvl]
Context	config>system>security>tacplus

Description This command configures TACACS+ authorization parameters for the system.

Default no authorization

use-priv-lvl — Automatically performs a single authorization request to the TACACS+ server for *cmd** (all commands) immediately after login, and then use the local profile associated (via the *priv-lvl-map*) with the *priv-lvl* returned by the TACACS+ server for all subsequent authorization (except *enable-admin*). After the initial authorization for *cmd**, no further authorization requests will be sent to the TACACS+ server (except *enable-admin*).

interactive-authentication

Syntax **[no] interactive-authentication**

Context config>system>security>tacplus

Description This configuration instructs SR OS to send no username nor password in the TACACS+ start message, and to display the *server_msg* in the GETUSER and GETPASS response from the TACACS+ server. Interactive authentication can be used to support a One Time Password scheme (e.g. S/Key). An example flow (e.g. with a telnet connection) is as follows:

- SR OS will send an authentication start request to the TACACS+ server with no username nor password.
- TACACS+ server replies with TAC_PLUS_AUTHEN_STATUS_GETUSER and a *server_msg*.
- SR OS displays the *server_msg*, and collects the user name.
- SR OS sends a continue message with the user name.
- TACACS+ server replies with TAC_PLUS_AUTHEN_STATUS_GETPASS and a *server_msg*.
- SR OS displays the *server_msg* (which may contain, for example, an S/Key for One Time Password operation), and collects the password.
- SR OS sends a continue message with the password.
- TACACS+ server replies with PASS or FAIL.

When interactive-authentication is disabled SR OS will send the username and password in the *tacplus* start message. An example flow (e.g. with a telnet connection) is as follows:

- TAC_PLUS_AUTHEN_TYPE_ASCII.
 - the login username in the “user” field.
 - the password in the *user_msg* field (note: this is non-standard but doesn’t cause interoperability problems).
- TACACS+ server ignores the password and replies with TAC_PLUS_AUTHEN_STATUS_GETPASS.
- SR OS sends a continue packet with the password in the *user_msg* field.
- TACACS+ server replies with PASS or FAIL.

When interactive-authentication is enabled, tacplus must be the first method specified in the authentication-order configuration.

Default no interactive-authentication

timeout

Syntax **timeout** *seconds*
no timeout

Context config>system>security>tacplus

Description This command configures the number of seconds the router waits for a response from a TACACS+ server.

The **no** form of the command reverts to the default value.

Default 3

Parameters *seconds* — The number of seconds the router waits for a response from a TACACS+ server, expressed as a decimal integer.

Values 1 — 90

shutdown

Syntax [**no**] **shutdown**

Context config>system>security>tacplus

Description This command administratively disables the TACACS+ protocol operation. Shutting down the protocol does not remove or change the configuration other than the administrative state.

The operational state of the entity is disabled as well as the operational state of any entities contained within. Many objects must be shut down before they may be deleted.

The **no** form of the command administratively enables the protocol which is the default state.

Default no shutdown

use-default-template

Syntax [**no**] **use-default-template**

Context config>system>security>tacplus

Description This command specifies whether or not the user template defined by this entry is to be actively applied to the TACACS+ user.

Generic 802.1x COMMANDS

dot1x

Syntax	[no] dot1x
Context	config>system>security
Description	This command creates the context to configure 802.1x network access control on the router. The no form of the command removes the 802.1x configuration.

radius-plcy

Syntax	[no] radius-plcy
Context	config>system>security> dot1x
Description	This command creates the context to configure RADIUS server parameters for 802.1x network access control on the router. NOTE: The RADIUS server configured under the config>system>security>dot1x>radius-plcy context authenticates clients who get access to the data plane of the router as opposed to the RADIUS server configured under the config>system>radius context which authenticates CLI login users who get access to the management plane of the router. The no form of the command removes the RADIUS server configuration for 802.1x.

retry

Syntax	retry count no retry
Context	config>system>security> dot1x
Description	This command configures the number of times the router attempts to contact the RADIUS server for authentication if there are problems communicating with the server. The no form of the command reverts to the default value.
Default	3
Parameters	<i>count</i> — The retry count. Values 1 — 10

server (dot1x)

Syntax	server <i>server-index</i> address <i>ip-address</i> secret <i>key</i> [hash hash2] [auth-port <i>auth-port</i>] [acct-port <i>acct-port</i>] [type <i>server-type</i>] no server <i>index</i>
Context	config>system>security> dot1x>radius-plcy
Description	This command adds a Dot1x server and configures the Dot1x server IP address, index, and key values. Up to five Dot1x servers can be configured at any one time. Dot1x servers are accessed in order from lowest to highest index for authentication requests until a response from a server is received. A higher indexed server is only queried if no response is received from a lower indexed server (which implies that the server is not available). If a response from a server is received, no other Dot1x servers are queried. It is assumed that there are multiple identical servers configured as backups and that the servers do not have redundant data. The no form of the command removes the server from the configuration.
Default	No Dot1x servers are configured.
Parameters	<p><i>server-index</i> — The index for the Dot1x server. The index determines the sequence in which the servers are queried for authentication requests. Servers are queried in order from lowest to highest index.</p> <p>Values 1 — 5</p> <p>address <i>ip-address</i> — The IP address of the Dot1x server. Two Dot1x servers cannot have the same IP address. An error message is generated if the server address is a duplicate.</p> <p>secret <i>key</i> — The secret key to access the Dot1x server. This secret key must match the password on the Dot1x server.</p> <p>Values Up to 128 characters in length.</p> <p>hash — Specifies the key is entered in an encrypted form. If the hash parameter is not used, the key is assumed to be in a non-encrypted, clear text form. For security, all keys are stored in encrypted form in the configuration file with the hash parameter specified.</p> <p>hash2 — Specifies the key is entered in a more complex encrypted form. If the hash2 parameter is not used, the less encrypted hash form is assumed.</p> <p>acct-port <i>acct-port</i> — The UDP port number on which to contact the RADIUS server for accounting requests.</p> <p>auth-port <i>auth-port</i> — specifies a UDP port number to be used as a match criteria.</p> <p>Values 1 — 65535</p> <p>type <i>server-type</i> — Specifies the server type.</p> <p>Values authorization, accounting, combined</p>

source-address

Syntax	source-address <i>ip-address</i> no source-address
Context	config>system>security> dot1x>radius-plcy
Description	This command configures the NAS IP address to be sent in the RADIUS packet. The no form of the command reverts to the default value.
Default	By default the System IP address is used in the NAS field.
Parameters	<i>ip-address</i> — The IP prefix for the IP match criterion in dotted decimal notation. Values 0.0.0.0 — 255.255.255.255

shutdown

Syntax	[no] shutdown
Context	config>system>security>dot1x config>system>security>dot1x>radius-plcy
Description	This command administratively disables the 802.1x protocol operation. Shutting down the protocol does not remove or change the configuration other than the administrative state. The operational state of the entity is disabled as well as the operational state of any entities contained within. The no form of the command administratively enables the protocol which is the default state.
Default	shutdown

timeout

Syntax	timeout <i>seconds</i> no timeout
Context	config>system>security> dot1x>radius-plcy
Description	This command configures the number of seconds the router waits for a response from a RADIUS server. The no form of the command reverts to the default value.
Default	3 seconds
Parameters	<i>seconds</i> — The number of seconds the router waits for a response from a RADIUS server, expressed as a decimal integer. Values 1 — 90

TCP Enhanced Authentication

keychain

Syntax	[no] keychain <i>keychain-name</i>
Context	config>system>security
Description	<p>This command enables the context to configure keychain parameters. A keychain must be configured on the system before it can be applied to a session.</p> <p>The no form of the command removes the keychain nodal context and everything under it from the configuration. If the keychain to be removed is in use when the no keychain command is entered, the command will not be accepted and an error indicating that the keychain is in use will be printed.</p>
Default	none
Parameters	<i>keychain-name</i> — Specifies a keychain name which identifies this particular keychain entry.
Values	An ASCII string up to 32 characters.

direction

Syntax	direction
Context	config>system>security>keychain
Description	This command specifies the data type that indicates the TCP stream direction to apply the keychain.
Default	none

bi

Syntax	bi
Context	config>system>security>keychain>direction
Description	This command configures keys for both send and receive stream directions.
Default	none

uni

Syntax	uni
Context	config>system>security>keychain>direction

TCP Enhanced Authentication

Description This command configures keys for send or receive stream directions.

Default none

receive

Syntax **receive**

Context config>system>security>keychain>direction>uni

Description This command enables the receive nodal context. Entries defined under this context are used to authenticate TCP segments that are being received by the router.

Default none

send

Syntax **send**

Context config>system>security>keychain>direction>uni

Description This command specifies the send nodal context to sign TCP segments that are being sent by the router to another device.

Default none

entry

Syntax **entry** *entry-id* **key** [*authentication-key* | *hash-key* | *hash2-key*] [**hash** | **hash2**] **algorithm**
algorithm
no entry *entry-id*

Context config>system>security>keychain>direction>bi
config>system>security>keychain>direction>uni>receive
config>system>security>keychain>direction>uni>send

Description This command defines a particular key in the keychain. Entries are defined by an entry-id. A keychain must have valid entries for the TCP Enhanced Authentication mechanism to work.

The **no** form of the command removes the entry from the keychain. If the entry is the active entry for sending, then this will cause a new active key to be selected (if one is available using the youngest key rule). If it is the **ONLY** possible send key, then the system will reject the command with an error indicating the configured key is the only available send key.

If the key is one of the eligible keys for receiving, it will be removed. If the key is the **ONLY** possible eligible key, then the command will not be accepted, and an error indicating that this is the only eligible key will be output.

The **no** form of the command deletes the entry.

Default	There are no default entries.
Parameters	<p><i>entry-id</i> — Specifies an entry that represents a key configuration to be applied to a keychain.</p> <p>Values 0 — 63</p> <p>key — Specifies a key ID which is used along with <i>keychain-name</i> and direction to uniquely identify this particular key entry.</p> <p><i>authentication-key</i> — Specifies the <i>authentication-key</i> that will be used by the encryption algorithm. The key is used to sign and authenticate a protocol packet.</p> <p>The <i>authentication-key</i> can be any combination of letters or numbers. .</p> <p>Values A key must be 160 bits for algorithm hmac-sha-1-96 and must be 128 bits for algorithm aes-128-cmac-96. If the key given with the entry command amounts to less than this number of bits, then it is padded internally with zero bits up to the correct length.</p> <p>algorithm-algorithm — Specifies an enumerated integer that indicates the encryption algorithm to be used by the key defined in the keychain.</p> <p>Values aes-128-cmac-96 — Specifies an algorithm based on the AES standard hmac-sha-1-96 — Specifies an algorithm based on SHA-1.</p> <p><i>hash-key</i> / <i>hash2-key</i> — The hash key. The key can be any combination of ASCII characters up to 33 for the <i>hash-key</i> and 96 characters for the <i>hash2-key</i> in length (encrypted). If spaces are used in the string, enclose the entire string in quotation marks (“ ”).</p> <p>This is useful when a user must configure the parameter, but, for security purposes, the actual unencrypted key value is not provided.</p> <p>hash — Specifies the key is entered in an encrypted form. If the hash parameter is not used, the key is assumed to be in a non-encrypted, clear text form. For security, all keys are stored in encrypted form in the configuration file with the hash parameter specified.</p> <p>hash2 — Specifies the key is entered in a more complex encrypted form.</p>

begin-time

Syntax	begin-time [<i>date</i>] [<i>hours-minutes</i>] [UTC] [now] [forever]
Context	config>system>security>keychain>direction>bi>entry config>system>security>keychain>direction>uni>receive>entry config>system>security>keychain>direction>uni>send>entry
Description	<p>This command specifies the calendar date and time after which the key specified by the keychain authentication key is used to sign and/or authenticate the protocol stream.</p> <p>If no date and time is set, the begin-time is represented by a date and time string with all NULLs and the key is not valid by default.</p>
Parameters	<i>date hours-minutes</i> — Specifies the date and time for the key to become active.

Values date: YYYY/MM/DD
 hours-minutes: hh:mm[:ss]

now — Specifies the the key should become active immediately.

forever — Specifies that the key should always be active.

end-time

Syntax **end-time** [*date*] [*hours-minutes*] [**UTC**] [**now**] [**forever**]

Context config>system>security>keychain>direction>uni>receive>entry
 config>system>security>keychain>direction>uni>send>entry

Description This command specifies the calendar date and time after which the key specified by the authentication key is no longer eligible to sign and/or authenticate the protocol stream.

Default forever

Parameters *date* — Specifies the calendar date after which the key specified by the authentication key is no longer eligible to sign and/or authenticate the protocol stream in the YYYY/MM/DD format. When no year is specified the system assumes the current year.

hours-minutes — Specifies the time after which the key specified by the authentication key is no longer eligible to sign and/or authenticate the protocol stream in the hh:mm[:ss] format. Seconds are optional, and if not included, assumed to be 0.

UTC — Indicates that time is given with reference to Coordinated Universal Time in the input.

now — Specifies a time equal to the current system time.

forever — Specifies a time beyond the current epoch.

tolerance

Syntax **tolerance** [*seconds* | **forever**]

Context config>system>security>keychain>direction>bi>entry
 config>system>security>keychain>direction>uni>receive>entry
 config>system>security>keychain>direction>uni>send>entry

Description This command configures the amount of time that an eligible receive key should overlap with the active send key or to never expire.

Parameters *seconds* — Specifies the duration that an eligible receive key overlaps with the active send key.

Values 0 — 4294967294 seconds

forever — Specifies that an eligible receive key overlap with the active send key forever.

tcp-option-number

Syntax	tcp-option-number
Context	config>system>security>keychain
Description	This command enables the context to configure the TCP option number to be placed in the TCP packet header.

receive

Syntax	receive <i>option-number</i>
Context	config>system>security>keychain>tcp-option-number
Description	This command configures the TCP option number accepted in TCP packets received.
Default	254
Parameters	<i>option-number</i> — Specifies an enumerated integer that indicates the TCP option number to be used in the TCP header.
Values	253, 254, 253&254

send

Syntax	send <i>option-number</i>
Context	config>system>security>keychain>tcp-option-number
Description	This command configures the TCP option number accepted in TCP packets sent.
Default	254
Parameters	<i>option-number</i> — Specifies an enumerated integer that indicates the TCP option number to be used in the TCP header.
Values	253, 254

CPM Filter Commands

cpm-filter

Syntax	cpm-filter
Context	config>system>security
Description	This command enables the context to configure a CPM filter. A CPM filter is a hardware filter done by the P chip on the CPMCFM that applies to all the traffic going to the CPM CPU. It can be used to drop, accept packets, as well as allocate dedicated hardware queues for the traffic. The no form of the command disables the CPM filter.

default-action

Syntax	default-action {accept drop}
Context	config>system>security>cpm-filter
Description	This command specifies the action to take on the traffic when the filter entry matches. If there are no filter entry defined, the packets received will either be dropped or forwarded based on that default action.
Default	accept
Parameters	accept — Specifies that packets matching the filter entry are forwarded. drop — Specifies that packets matching the filter entry are dropped.

ip-filter

Syntax	[no] ip-filter
Context	config>system>security>cpm-filter
Description	This command enables the context to configure CPM IP filter parameters.
Default	shutdown

ipv6-filter

Syntax	[no] ipv6-filter
Context	config>system>security>cpm-filter

Description

Description This command enables the context to configure CPM IPv6 filter parameters.

Default shutdown

mac-filter

Syntax **[no] mac-filter**

Context config>system>security>cpm-filter

Description This command enables the context to configure CPM MAC-filter parameters.

Default shutdown

entry

Syntax **entry entry-id**

Context config>sys>sec>cpm>ip-filter
config>sys>sec>cpm>ipv6-filter
config>sys>sec>cpm>mac-filter

Description This command specifies a particular CPM filter match entry. Every CPM filter must have at least one filter match entry. Entries are created and deleted by user.

The default match criteria is match none.

Parameters *entry-id* — Identifies a CPM filter entry as configured on this system.

Values 1 — 2048

action

Syntax **action [accept | drop | queue queue-id]**
no action

Context config>sys>sec>cpm>ip-filter>entry
config>sys>sec>cpm>ipv6-filter>entry
config>sys>sec>cpm>mac-filter>entry

Description This command specifies the action to take for packets that match this filter entry.

Default drop

Parameters **accept** — Specifies packets matching the entry criteria will be forwarded.
drop — Specifies packets matching the entry criteria will be dropped.

queue *queue-id* — Specifies packets matching the entry criteria will be forward to the specified CPM hardware queue.

log

Syntax	log <i>log-id</i>
Context	config>sys>sec>cpm>ip-filter>entry config>sys>sec>cpm>ipv6-filter>entry config>sys>sec>cpm>mac-filter>entry
Description	This command specifies the log in which packets matching this entry should be entered. The value zero indicates that logging is disabled. The no form of the command deletes the log ID.
Parameters	<i>log-id</i> — Specifies the log ID where packets matching this entry should be entered.

match

Syntax	match [protocol <i>protocol-id</i>] no match
Context	config>sys>sec>cpm>ip-filter>entry
Description	This command enables the context to enter match criteria for the filter entry. When the match criteria have been satisfied the action associated with the match criteria is executed. If more than one match criteria (within one match statement) are configured then all criteria must be satisfied (AND function) before the action associated with the match is executed. A match context may consist of multiple match criteria, but multiple match statements cannot be entered per entry. The no form of the command removes the match criteria for the <i>entry-id</i> .
Parameters	protocol — Configures an IP protocol to be used as an IP filter match criterion. The protocol type such as TCP or UDP is identified by its respective protocol number. <i>protocol-id</i> — Configures the decimal value representing the IP protocol to be used as an IP filter match criterion. Well known protocol numbers include ICMP(1), TCP(6), UDP(17). The no form the command removes the protocol from the match criteria. Values 1 — 255 (values can be expressed in decimal, hexadecimal, or binary) keywords - none, crtp, crudp, egp, eigrp, encap, ether-ip, gre, icmp, idrp, igmp, igp, ip, ipv6, ipv6-frag, ipv6-icmp, ipv6-no-nxt, ipv6-opts, ipv6-route, isis, iso-ip, l2tp, ospf-igp, pnni, ptp, rdp, rsvp, stp, tcp, udp, vrrp, * — udp/tcp wildcard

Table 9: IP Protocol Names

Protocol	Protocol ID	Description
icmp	1	Internet Control Message
igmp	2	Internet Group Management
ip	4	IP in IP (encapsulation)
tcp	6	Transmission Control
egp	8	Exterior Gateway Protocol
igp	9	any private interior gateway (used by Cisco for their IGRP)
udp	17	User Datagram
rdp	27	Reliable Data Protocol
ipv6	41	IPv6
ipv6-route	43	Routing Header for IPv6
ipv6-frag	44	Fragment Header for IPv6
idrp	45	Inter-Domain Routing Protocol
rsvp	46	Reservation Protocol
gre	47	General Routing Encapsulation
ipv6-icmp	58	ICMP for IPv6
ipv6-no-nxt	59	No Next Header for IPv6
ipv6-opts	60	Destination Options for IPv6
iso-ip	80	ISO Internet Protocol
eigrp	88	EIGRP
ospf-igp	89	OSPF/IGP
ether-ip	97	Ethernet-within-IP Encapsulation
encap	98	Encapsulation Header
pnni	102	PNNI over IP
pim	103	Protocol Independent Multicast
vrrp	112	Virtual Router Redundancy Protocol
l2tp	115	Layer Two Tunneling Protocol
stp	118	Spanning Tree Protocol
ptp	123	Performance Transparency Protocol
isis	124	ISIS over IPv4
crtmp	126	Combat Radio Transport Protocol
crudp	127	Combat Radio User Datagram

match

Syntax	match [next-header <i>next-header</i>] no match
Context	config>sys>sec>cpm>ipv6-filter>entry
Description	This command specifies match criteria for the IP filter entry. The no form of this command removes the match criteria for the <i>entry-id</i> .
Parameters	next-header <i>next-header</i> — Specifies the next header to match. The protocol type such as TCP / UDP / OSPF is identified by its respective protocol number. Well-known protocol numbers include ICMP(1), TCP(6), UDP(17). Values next-header: 1 — 42, 45— 49, 52— 59, 61— 255 protocol numbers accepted in DHB keywords: none, crtp, crudp, egp, eigrp, encap, ether-ip, gre, icmp, idrp, igmp, igp, ip, ipv6, ipv6-icmp, ipv6-no-nxt, isis, iso-ip, l2tp, ospf-igp, pim, pnni, ptp, rdp, rsvp, stp, tcp, udp, vrrp * — udp/tcp wildcard

action

Syntax	action { permit deny } no action
Context	config>system>security>mgmt-access-filter>mac-filter
Description	This command creates the action associated with the management access filter match criteria entry. The action keyword is required. If no action is defined, the filter is ignored. If multiple action statements are configured, the last one overwrites previous configured actions. If the packet does not meet any of the match criteria the configured default action is applied.
Default	none — The action is specified by default-action command.
Parameters	permit — Specifies that packets matching the configured criteria will be permitted. deny — Specifies that packets matching the configured selection criteria will be denied and that a ICMP host unreachable message will not be issued.

default-action

Syntax	default-action { permit deny }
Context	config>system>security>mgmt-access-filter>mac-filter
Description	This command creates the default action for management access in the absence of a specific management access filter match. The default-action is applied to a packet that does not satisfy any match criteria in any of the management access filters. Whenever management access filters are configured, the default-action must be defined.
Default	No default-action is defined.
Parameters	permit — Specifies that packets not matching the configured selection criteria in any of the filter entries will be permitted. deny — Specifies that packets not matching the selection criteria be denied and that an ICMP host unreachable message will not be issued.

dscp

Syntax	dscp <i>dscp-name</i> no dscp
Context	config>sys>sec>cpm>ip-filter>entry>match config>sys>sec>cpm>ipv6-filter>entry>match config>sys>sec>cpm>mac-filter>entry>match
Description	This command configures a DiffServ Code Point (DSCP) name to be used as an IP filter match criterion. The no form of the command removes the DSCP match criterion.
Default	no dscp — No dscp match criterion.
Parameters	<i>dscp-name</i> — Configures a dscp name that has been previously mapped to a value using the dscp-name command. The DiffServ code point may only be specified by its name.

dst-ip

Syntax	dst-ip <i>ipv6-address/prefix-length</i> dst-ip ipv6-prefix-list <i>ipv6-prefix-list-name</i> no dst-ip
Context	config>sys>sec>cpm>ip-filter>entry>match
Description	This command configures a destination IP address range to be used as an IP filter match criterion. To match on the destination IP address, specify the address and its associated mask, for example, 10.1.0.0/16. The conventional notation of 10.1.0.0 255.255.0.0 may also be used. The no form of the command removes the destination IP address match criterion.

- Default** No destination IP match criterion
- Parameters** *ip-address* — Specifies the IP address for the IP match criterion in dotted decimal notation.
- Values** 0.0.0.0 — 255.255.255.255
- ip-prefix-list** — Creates a list of IPv4 prefixes for match criteria in IPv4 ACL and CPM filter policies.
- ip-prefix-list-name* — A string of up to 32 characters of printable ASCII characters. If special characters are used, the string must be enclosed within double quotes.
- mask* — Specifies the subnet mask length expressed as a decimal integer.
- Values** 1 — 32
- netmask* — Specifies the dotted quad equivalent of the mask length.
- Values** 0.0.0.0 — 255.255.255.255

dst-ip

- Syntax** **dst-ip** [*ipv6-address /prefix-length*] [**ipv6-prefix-list** *ipv6-prefix-list-name*]
no dst-ip
- Context** config>sys>sec>cpm>ipv6-filter>entry>match
- Description** This command configures a destination IPv6 address range to be used as an IPv6 filter match criterion.
- To match on the destination IPv6 address, specify the address.
- The **no** form of the command removes the destination IP address match criterion.
- Default** No destination IP match criterion
- Parameters** *ipv6-address/prefix-length* — Specifies the IPv6 address for the IPv6 match criterion in dotted decimal notation. An IPv6 IP address is written as eight 4-digit (16-bit) hexadecimal numbers separated by colons. One string of zeros per address can be left out, so that 1010::700:0:217A is the same as 1010:0:0:0:700:0:217A.
- Values** x:x:x:x:x:x:x (eight 16-bit pieces)
x:x:x:x:x:d.d.d.d
- x: [0 — .FFFF]H
d: [0 — 255]D
- prefix-length: 1 — 128
- ipv6-prefix-list** — Creates a list of IPv4 prefixes for match criteria in IPv4 ACL and CPM filter policies.
- ipv6-prefix-list-name* — A string of up to 32 characters of printable ASCII characters. If special characters are used, the string must be enclosed within double quotes.

dst-port

Syntax	dst-port [tcp/udp <i>port-number</i>] [<i>mask</i>] dst-port port-list <i>port-list-name</i> dst-port range <i>tcp/udp port-number tcp/udp port-number</i> no dst-port
Context	config>sys>sec>cpm>ip-filter>entry>match config>sys>sec>cpm>ipv6-filter>entry>match
Description	This command specifies the TCP/UDP port or port name to match the destination-port of the packet. Note that an entry containing Layer 4 match criteria will not match non-initial (2nd, 3rd, etc) fragments of a fragmented packet since only the first fragment contains the Layer 4 information. The no form of the command removes the destination port match criterion.
Parameters	<i>tcp/udp port-number</i> — Specifies the destination port number to be used as a match criteria expressed as a decimal integer. Values 0 — 65535 (accepted in decimal hex or binary) <i>port-list-name</i> — Specifies the port list name to be used as a match criteria for the destination port. <i>mask</i> — Specifies the 16 bit mask to be applied when matching the destination port. Values [0x0000..0xFFFF] [0..65535] [0b0000000000000000..0b1111111111111111]

flow-label

Syntax	flow-label <i>value</i> no flow-label
Context	config>sys>sec>cpm>ipv6-filter>entry>match
Description	This command configures flow label match conditions. Flow labeling enables the labeling of packets belonging to particular traffic flows for which the sender requests special handling, such as non-default quality of service or real-time service.
Parameters	<i>value</i> — Specify the flow identifier in an IPv6 packet header that can be used to discriminate traffic flows (See RFC 3595, <i>Textual Conventions for IPv6 Flow Label</i>). Values 0 — 1048575

fragment

Syntax **fragment** {true | false}

no fragment

Context	config>sys>sec>cpm>ip-filter>entry>match config>sys>sec>cpm>ipv6-filter>entry>match
Description	<p>This command specifies fragmented or non-fragmented IP packets as an IP filter match criterion. Note that an entry containing Layer 4 match criteria will not match non-initial (2nd, 3rd, etc) fragments of a fragmented packet since only the first fragment contains the Layer 4 information.</p> <p>This command enables match on existence of IPv6 Fragmentation Extension Header in the IPv6 filter policy. To match first fragment of an IP fragmented packet, specify additional Layer 4 matching criteria in a filter policy entry. The no version of this command ignores IPv6 Fragmentation Extension Header presence/absence in a packet when evaluating match criteria of a given filter policy entry.</p> <p>The no form of the command removes the match criterion.</p> <p>This command enables match on existence of IPv6 Fragmentation Extension Header in the IPv6 filter policy. To match first fragment of an IP fragmented packet, specify additional Layer 4 matching criteria in a filter policy entry. The no version of this command ignores IPv6 Fragmentation Extension Header presence/absence in a packet when evaluating match criteria of a given filter policy entry.</p>
Default	no fragment
Parameters	<p>true — Specifies to match on all fragmented IP packets. A match will occur for all packets that have either the MF (more fragment) bit set or have the Fragment Offset field of the IP header set to a non-zero value. For IPv6, packet matches if it contains IPv6 Fragmentation Extension Header.</p> <p>false — Specifies to match on all non-fragmented IP packets. Non-fragmented IP packets are packets that have the MF bit set to zero and have the Fragment Offset field also set to zero. For IPv6, packet matches if it does not contain IPv6 Fragmentation Extension Header.</p>

hop-by-hop-opt

Syntax	hop-by-hop-opt {true false} no hop-by-hop-opt
Context	config>sys>sec>cpm>ipv6-filter>entry>match
Description	<p>This command enables match on existence of Hop-by-Hop Options Extension Header in the IPv6 filter policy.</p> <p>The no form of this command ignores Hop-by-Hop Options Extension Header presence/absence in a packet when evaluating match criteria of a given filter policy entry.</p>
Default	no hop-by-hop-opt
Parameters	<p>true — Match if a packet contains Hop-by-Hop Options Extension Header.</p> <p>false — Match if a packet does not contain Hop-by-Hop Options Extension Header.</p>

icmp-code

Syntax	icmp-code <i>icmp-code</i> no icmp-code
Context	config>sys>sec>cpm>ip-filter>entry>match config>sys>sec>cpm>ipv6-filter>entry>match
Description	
Description	This command configures matching on ICMP code field in the ICMP header of an IP packet as an IP filter match criterion. Note that an entry containing Layer 4 match criteria will not match non-initial (2nd, 3rd, etc) fragments of a fragmented packet since only the first fragment contains the Layer 4 information. The behavior of the icmp-code value is dependent on the configured icmp-type value, thus a configuration with only an icmp-code value specified will have no effect. To match on the icmp-code , an associated icmp-type must also be specified. The no form of the command removes the criterion from the match entry.
Default	no icmp-code - no match criterion for the ICMP code.
Parameters	<i>icmp-code</i> — Specifies the ICMP code values that must be present to match. Values 0 — 255

icmp-type

Syntax	icmp-type <i>icmp-type</i> no icmp-type
Context	config>sys>sec>cpm>ip-filter>entry>match config>sys>sec>cpm>ipv6-filter>entry>match
Description	This command configures matching on ICMP type field in the ICMP header of an IP packet as an IP filter match criterion. Note that an entry containing Layer 4 match criteria will not match non-initial (2nd, 3rd, etc) fragments of a fragmented packet since only the first fragment contains the Layer 4 information. The no form of the command removes the criterion from the match entry.
Default	no icmp-type — No match criterion for the ICMP type.

Parameters *icmp-type* — Specifies the ICMP type values that must be present to match.
Values 0 — 255

ip-option

Syntax **ip-option** *ip-option-value ip-option-mask*
no ip-option

Context config>sys>sec>cpm>ip-filter>entry>match

Description This command configures matching packets with a specific IP option or a range of IP options in the IP header as an IP filter match criterion.
 The option-type octet contains 3 fields:

- 1 bit copied flag (copy options in all fragments)
- 2 bits option class,
- 5 bits option number.

The **no** form of the command removes the match criterion.

Default No IP option match criterion

Parameters *ip-option-value* — Enter the 8 bit option-type as a decimal integer. The mask is applied as an AND to the option byte, the result is compared with the option-value.
 The decimal value entered for the match should be a combined value of the eight bit option type field and not just the option number. Thus to match on IP packets that contain the Router Alert option (option number =20), enter the option type of 148 (10010100).
Values 0 — 255
ip-option-mask — Specifies a range of option numbers to use as the match criteria.

This 8 bit mask can be configured using the following formats:

Format Style	Format Syntax	Example
Decimal	DDD	20
Hexadecimal	0xHH	0x14
Binary	0bBBBBBBBB	0b0010100
Default	255 (decimal) (exact match)	
Values	1 — 255 (decimal)	

multiple-option

Syntax **multiple-option** {true | false}

no multiple-option

Context	config>sys>sec>cpm>ip-filter>entry>match
Description	This command configures matching packets that contain more than one option fields in the IP header as an IP filter match criterion. The no form of the command removes the checking of the number of option fields in the IP header as a match criterion.
Default	no multiple-option — No checking for the number of option fields in the IP header
Parameters	true — Specifies matching on IP packets that contain more that one option field in the header. false — Specifies matching on IP packets that do not contain multiple option fields present in the header.

option-present

Syntax	option-present {true false} no option-present
Context	config>sys>sec>cpm>ip-filter>entry>match
Description	This command configures matching packets that contain the option field or have an option field of zero in the IP header as an IP filter match criterion. The no form of the command removes the checking of the option field in the IP header as a match criterion.
Parameters	true — Specifies matching on all IP packets that contain the option field in the header. A match will occur for all packets that have the option field present. An option field of zero is considered as no option present. false — Specifies matching on IP packets that do not have any option field present in the IP header (an option field of zero). An option field of zero is considered as no option present.

router

Syntax	router service-name <i>service-name</i> router <i>router-instance</i> no router
Context	config>sys>sec>cpm>ip-filter>entry>match config>sys>sec>cpm>ipv6-filter>entry>match
Description	This command specifies a router name or a service-id to be used in the match criteria.
Parameters	<i>router-instance</i> — Specify one of the following parameters for the router instance:

router-name — Specifies a router name up to 32 characters to be used in the match criteria.

service-id — Specifies an existing service ID to be used in the match criteria.

Values 1 — 2147483647

service-name *service-name* — Specifies an existing service name up to 64 characters in length.

src-ip

Syntax **src-ip** [*ip-address/mask* | **ip-prefix-list** *prefix-list-name*]
no src-ip

Context config>sys>sec>cpm>ip-filter>entry>match

Description This command specifies the IP address to match the source IP address of the packet. To match on the source IP address, specify the address and its associated mask, such as 10.1.0.0/16. The conventional notation of 10.1.0.0 255.255.0.0 may also be used. The **no** form of the command removes the source IP address match criterion.

Default **no src-ip** — No source IP match criterion.

Parameters *ip-address/mask* — Specifies the IP address for the match criterion in dotted decimal notation. An IP address is written as eight 4-digit (16-bit) hexadecimal numbers separated by colons. One string of zeros per address can be left out, so that 1010::700:0:217A is the same as 1010:0:0:0:700:0:217A.

Values

ipv4-address	a.b.c.d (host bits must be 0)
	x:x:x:x:x:d.d.d.d[-interface]
	x: [0..FFFF]H
	d: [0..255]D
	interface: 32 characters maximum, mandatory for link local addresses
mask:	Specifies the 16 bit mask to be applied when matching the source IP address.
	1 — 32

ip-prefix-list — Creates a list of IPv4 prefixes for match criteria in IPv4 ACL and CPM filter policies.

ip-prefix-list-name — A string of up to 32 characters of printable ASCII characters. If special characters are used, the string must be enclosed within double quotes.

src-ip

Syntax	src-ip [<i>ip-address/mask</i> ipv6-prefix-list <i>ipv6-prefix-list-name</i>] no src-ip				
Context	config>sys>sec>cpm>ipv6-filter>entry>match				
Description	This command specifies the IPv6 address to match the source IPv6 address of the packet. To match on the source IP address, specify the address and its associated mask, such as 10.1.0.0/16. The conventional notation of 10.1.0.0 255.255.0.0 may also be used. The no form of the command removes the source IP address match criterion.				
Default	no src-ip — No source IP match criterion.				
Parameters	<i>ip-address/mask</i> — Specifies the IP address for the match criterion in dotted decimal notation. An IP address is written as eight 4-digit (16-bit) hexadecimal numbers separated by colons. One string of zeros per address can be left out, so that 1010::700:0:217A is the same as 1010:0:0:0:700:0:217A. Values <table> <tr> <td>ipv6-address</td> <td>x:x:x:x:x:x:x[-interface] x:x:x:x:x:d.d.d.d[-interface] x: [0..FFFF]H d: [0..255]D interface: 32 characters maximum, mandatory for link local addresses</td> </tr> <tr> <td>mask:</td> <td>Specifies eight 16-bit hexadecimal pieces representing bit match criteria. Values x:x:x:x:x:x (eight 16-bit pieces)</td> </tr> </table> ipv6-prefix-list — Creates a list of IPv6 prefixes for match criteria in IPv6 ACL and CPM filter policies. <i>ipv6-prefix-list-name</i> — A string of up to 32 characters of printable ASCII characters. If special characters are used, the string must be enclosed within double quotes.	ipv6-address	x:x:x:x:x:x:x[-interface] x:x:x:x:x:d.d.d.d[-interface] x: [0..FFFF]H d: [0..255]D interface: 32 characters maximum, mandatory for link local addresses	mask:	Specifies eight 16-bit hexadecimal pieces representing bit match criteria. Values x:x:x:x:x:x (eight 16-bit pieces)
ipv6-address	x:x:x:x:x:x:x[-interface] x:x:x:x:x:d.d.d.d[-interface] x: [0..FFFF]H d: [0..255]D interface: 32 characters maximum, mandatory for link local addresses				
mask:	Specifies eight 16-bit hexadecimal pieces representing bit match criteria. Values x:x:x:x:x:x (eight 16-bit pieces)				

src-port

Syntax	src-port <i>src-port-number</i> [<i>mask</i>]
Context	config>sys>sec>cpm>ip-filter>entry>match config>sys>sec>cpm>ipv6-filter>entry>match
Description	This command specifies the TCP/UDP port to match the source port of the packet. Note that an entry containing Layer 4 match criteria will not match non-initial (2nd, 3rd, etc) fragments of a fragmented packet since only the first fragment contains the Layer 4 information.
Parameters	<i>src-port-number</i> — The source port number to be used as a match criteria expressed as a decimal integer. Values 0 — 65535

mask — Specifies the 16 bit mask to be applied when matching the source port.

Values 0 — 128

tcp-ack

Syntax	tcp-ack {true false} no tcp-ack
Context	config>sys>sec>cpm>ip-filter>entry>match config>sys>sec>cpm>ipv6-filter>entry>match
Description	<p>This command configures matching on the ACK bit being set or reset in the control bits of the TCP header of an IP or IPv6 packet as an IP filter match criterion. Note that an entry containing Layer 4 match criteria will not match non-initial (2nd, 3rd, etc) fragments of a fragmented packet since only the first fragment contains the Layer 4 information.</p> <p>The no form of the command removes the criterion from the match entry.</p>
Default	No match criterion for the ACK bit
Parameters	<p>true — Specifies matching on IP or IPv6 packets that have the ACK bit set in the control bits of the TCP header of an IP or IPv6 packet.</p> <p>false — Specifies matching on IP or IPv6 packets that do not have the ACK bit set in the control bits of the TCP header of the IP or IPv6 packet.</p>

tcp-syn

Syntax	tcp-syn {true false} no tcp-syn
Context	config>sys>sec>cpm>ip-filter>entry>match config>sys>sec>cpm>ipv6-filter>entry>match config>sys>sec>cpm>ipv6-filter>entry>match
Description	<p>This command configures matching on the SYN bit being set or reset in the control bits of the TCP header of an IP or IPv6 packet as an IP filter match criterion. Note that an entry containing Layer 4 match criteria will not match non-initial (2nd, 3rd, etc) fragments of a fragmented packet since only the first fragment contains the Layer 4 information.</p> <p>The SYN bit is normally set when the source of the packet wants to initiate a TCP session with the specified destination IP or IPv6 address.</p> <p>The no form of the command removes the criterion from the match entry.</p>
Default	No match criterion for the SYN bit
Description	Use the no form of this command to remove this as a criterion from the match entry.
Default	none

- Parameters** **true** — Specifies matching on IP or IPv6 packets that have the SYN bit set in the control bits of the TCP header.
- false** — Specifies matching on IP or IPv6 packets that do not have the SYN bit set in the control bits of the TCP header.

renum

- Syntax** **renum** *old-entry-id new-entry-id*
- Context** config>sys>sec>cpm>ip-filter
config>sys>sec>cpm>ipv6-filter>entry>match
config>sys>sec>cpm>mac-filter>entry>match
- Description**
- Description** This command renumbers existing IP(IPv4), IPv6, or MAC filter entries to re-sequence filter entries. This may be required in some cases since the OS exits when the first match is found and execute the actions according to the accompanying action command. This requires that entries be sequenced correctly from most to least explicit.
- Parameters** *old-entry-id* — Enter the entry number of an existing entry.
- Values** 1 — 2048
- new-entry-id* — Enter the new entry-number to be assigned to the old entry.
- Values** 1 — 2048

shutdown

- Syntax** **shutdown**
- Context** config>sys>sec>cpm>ip-filter
config>sys>sec>cpm>ipv6-filter
config>sys>sec>cpm>mac-filter
- Description** This command enables IP(v4), IPv6 or MAC CPM filter. The **no** form of this command disable the filter.
- Default** shutdown

CPM Queue Commands

cpm-queue

Syntax	cpm-queue
Context	config>system>security
Description	This command enables the context to configure a CPM queue.

queue

Syntax	queue <i>queue-id</i>
Context	config>system>security>cpm-queue
Description	This command allows users to allocate dedicated CPM.

cbs

Syntax	cbs <i>cbs</i> no cbs
Context	config>system>cpm-queue>queue
Description	This command specifies the amount of buffer that can be drawn from the reserved buffer portion of the queue's buffer pool.
Parameters	<i>cbs</i> — Specifies the committed burst size in kbytes.

mbs

Syntax	mbs <i>mbs</i> no mbs
Context	config>system>security>cpm-queue>queue
Description	This command specifies the maximum queue depth to which a queue can grow.
Parameters	<i>mbs</i> — Specifies the maximum burst size in kbytes.

rate

Syntax	rate <i>rate</i> [cir <i>cir</i>] no rate
Context	config>system>security>cpm-queue>queue
Description	This command specifies the maximum bandwidth that will be made available to the queue in kilobits per second (kbps).
Parameters	<i>rate</i> — Specifies the administrative Peak Information Rate (PIR) for the queue. cir <i>cir</i> — Specifies the amount of bandwidth committed to the queue.

TTL Security Commands

ttl-security

Syntax	ttl-security <i>min-ttl-value</i> no ttl-security
Context	config>router>bgp>group config>router>bgp>group>neighbor configure>router>ldp>peer-parameters>peer config>system>login-control>ssh config>system>login-control>telnet
Description	This command configures TTL security parameters for incoming packets. When the feature is enabled, LDP will accept incoming IP packets from a peer only if the TTL value in the packet is greater than or equal to the minimum TTL value configured for that peer. Per-peer-queueing must be enabled in order for TTL protection to operate. The no form of the command disables TTL security.
Parameters	<i>min-ttl-value</i> — Specify the minimum TTL value for an incoming BGP packet. Values 1 — 255

ttl-security

Syntax	ttl-security <i>min-ttl-value</i> no ttl-security
Context	config>router>ldp>peer-parameters>peer
Description	This command configures TTL security parameters for incoming packets. When the feature is enabled, BGP will accept incoming IP packets from a peer only if the TTL value in the packet is greater than or equal to the minimum TTL value configured for that peer. Per-peer-queueing must be enabled in order for TTL protection to operate. The no form of the command disables TTL security.
Default	no ttl-security
Parameters	<i>min-ttl-value</i> — Specifies the minimum TTL value for an incoming LDP packet. Values 1 — 255

ttl-security

Syntax	ttl-security <i>min-ttl-value</i> no ttl-security
Context	config>system>login-control>ssh config>system>login-control>telnet
Description	<p>This command configures TTL security parameters for incoming packets. When the feature is enabled, SSH/Telnet will accept incoming IP packets from a peer only if the TTL value in the packet is greater than or equal to the minimum TTL value configured for that peer. Per-peer-queueing must be enabled in order for TTL protection to operate.</p> <p>The no form of the command disables TTL security.</p>
Parameters	<i>min-ttl-value</i> — Specify the minimum TTL value for an incoming BGP packet.
Values	1 — 255

CPU Protection Commands

cpu-protection

Syntax	cpu-protection
Context	config>sys>security
Description	This command enters the context to configure CPU protection parameters.

included-protocols

Syntax	included-protocols
Context	config>sys>security>cpu-protection> ip>included-protocols
Description	This context allows configuration of which protocols are included for ip-src-monitoring. This is system-wide configuration that applies to cpu protection globally.

dhcp

Syntax	[no] dhcp
Context	config>sys>security>cpu-protection> ip>included-protocols
Description	Include extracted IPv4 DHCP packets for ip-src-monitoring. IPv4 DHCP packets will be subject to the per-source-rate of cpu protection policies.
Default	dhcp (note this is different than the other protocols)

link-specific-rate

Syntax	link-specific-rate <i>packet-rate-limit</i> no link-specific-rate
Context	config>sys>security>cpu-protection
Description	This command configures a link-specific rate for CPU protection. This limit is applied to all ports within the system. The CPU will receive no more than the configured packet rate for all link level protocols such as LACP from any one port. The measurement is cleared each second and is based on the ingress port.
Default	max (no limit)

Parameters	<i>packet-rate-limit</i> — Specifies a packet arrival rate limit, in packets per second, for link level protocols.
Values	1 — 65535, max (no limit)
Default	15000

policy

Syntax	policy <i>cpu-protection-policy-id</i> [create] no policy <i>cpu-protection-policy-id</i>
Context	config>sys>security>cpu-protection
Description	This command configures CPU protection policies. The no form of the command deletes the specified policy from the configuration. Policies 254 and 255 are reserved as the default access and network interface policies, and cannot be deleted. The parameters within these policies can be modified. An event will be logged (warning) when the default policies are modified.
Default	Policy 254 (default access interface policy): per-source-rate: max (no limit) overall-rate : 6000 out-profile-rate: 6000 alarm Policy 255 (default network interface policy): per-source-rate: max (no limit) overall-rate : max (no limit) out-profile-rate: 3000 alarm
Parameters	<i>cpu-protection-policy-id</i> — Assigns a policy ID to the specific CPU protection policy.
Values	1 — 255
	create — Keyword used to create CPU protection policy. The create keyword requirement can be enabled/disabled in the environment>create context.

alarm

Syntax	[no] alarm
Context	config>sys>security>cpu-protection>policy

CPU Protection Commands

Description	This command enables the generation of an event when a rate is exceeded. The event includes information about the offending source. Only one event is generated per monitor period. The no form of the command disables the notifications.
Default	no alarm

eth-cfm

Syntax	eth-cfm no eth-cfm
Context	config>sys>security>cpu-protection>policy
Description	Provides the construct under which the different entries within CPU policy can define the match criteria and overall arrival rate of the Ethernet Configuration and Fault Management (ETH-CFM) packets at the CPU.
Default	None

entry

Syntax	entry <entry> levels <levels> opcodes <opcodes> rate <packet-rate-limit> no entry
Context	config>sys>security>cpu-protection>eth-cfm>
Description	Builds the specific match and rate criteria. Up to ten entries may exist in up to four CPU protection policies. The no form of the command reverses the match and rate criteria configured.
Default	no entry
Parameters	rate — Specifies a packet rate limit in frames per second, where a '0' means drop all. Values 1 —100 level — Specifies a domain level. Values all Wildcard entry level range 0 —7: within specified range, multiple ranges allowed number 0 ... 7: specific level number, may be combined with range opcode — Specifies an operational code that identifies the application. Values range 0 —255: within specified range, multiple ranges allowed number 0 .. .255: specific level number, may be combined with range

out-profile-rate

Syntax	out-profile-rate <i>packet-rate-limit</i> [log-event] no out-profile-rate
Context	config>sys>security>cpu-protection>policy
Description	This command applies a packet arrival rate limit for the entire SAP/interface, above which packets will be marked as discard eligible. The rate defined is a global rate limit for the interface regardless of the number of traffic flows. It is a per-SAP/interface rate. The no form of the command sets out-profile-rate parameter back to the default value.
Default	3000 for cpu-protection-policy-id 1-253 6000 for cpu-protection-policy-id 254 (default access interface policy) 3000 for cpu-protection-policy-id 255 (default network interface policy)
Parameters	<i>packet-rate-limit</i> — Specifies a packet arrival rate limit in packets per second. Values 1 — 65535, max (max indicates no limit) log-events — issues a tmnxCpmProtViolSapOutProf, tmnxCpmProtViolIfOutProf, or tmnxCpmProtViolSdpBindOutProf log event and tracks violating interfaces when the out-profile-rate is exceeded. Supported on CPM3 and above only.

overall-rate

Syntax	overall-rate <i>packet-rate-limit</i> no overall-rate
Context	config>sys>security>cpu-protection>policy
Description	This command applies a maximum packet arrival rate limit (applied per SAP/interface) for the entire SAP/interface, above which packets will be discarded immediately. The rate defined is a global rate limit for the interface regardless of how many traffic flows are present on the SAP/interface. It is a per-SAP/interface rate. The no form of the command sets overall-rate parameter back to the default value.
Default	max for cpu-protection-policy-id 1 — 253 6000 for cpu-protection-policy-id 254 (default access interface policy) max for cpu-protection-policy-id 255 (default network interface policy)
Parameters	<i>packet-rate-limit</i> — Specifies a packet arrival rate limit in packets per second. Values 1 — 65535, max (max indicates no limit)

per-source-rate

Syntax	per-source-rate <i>packet-rate-limit</i> no per-source-rate
---------------	--

Context	config>sys>security>cpu-protection>policy
Description	<p>This command configures a per-source packet arrival rate limit. Use this command to apply a packet arrival rate limit on a per source basis. A source is defined as a unique combination of SAP and MAC source address (mac-monitoring) or SAP and source IP address (ip-src-monitoring). The CPU will receive no more than the configured packet rate from each source (only certain protocols are rate limited for ip-src-monitoring as configured under 'include-protocols' in the cpu protection policy). The measurement is cleared each second.</p> <p>This parameter is only applicable if the policy is assigned to an interface (some examples include saps, subscriber-interfaces, and spoke-sdps), and the mac-monitor or ip-src-monitor keyword is specified in the cpu-protection configuration of that interface.</p> <p>The ip-src-monitoring is useful in subscriber management architectures that have routers between the subscriber and the BNG (router). In layer-3 aggregation scenarios, all packets from all subscribers behind the same aggregation router will arrive with the same source MAC address and as such the mac-monitoring functionality can not differentiate traffic from different subscribers.</p>
Default	max, no limit
Parameters	<p><i>packet-rate-limit</i> — Specifies a per-source packet (per SAP/MAC source address or per SAP/IP source address) arrival rate limit in packets per second.</p> <p>Values 1 — 65535, max (max indicates no limit)</p>

port-overall-rate

Syntax	port-overall-rate <i>packet-rate-limit</i> [low-action-priority] no port-overall-rate
Context	config>sys>security>cpu-protection
Description	This command configures a per-port overall rate limit for CPU protection.
Parameters	<p><i>packet-rate-limit</i> — Specifies an overall per-port packet arrival rate limit in packets per second.</p> <p>Values 1 — 65535, max (indicates no limit)</p> <p>action-low-priority — Marks packets that exceed the rate as low-priority (for preferential discard later if there is congestion in the control plane) instead of discarding them immediately.</p> <p>Default max</p>

protocol-protection

Syntax	protocol-protection [allow-sham-links] [block-pim-tunneled] no protocol-protection
Context	config>sys>security>cpu-protection

Description	This command causes the network processor on the CPM to discard all packets received for protocols that are not configured on the particular interface. This helps mitigate DoS attacks by filtering invalid control traffic before it hits the CPU. For example, if an interface does not have IS-IS configured, then protocol protection will discard any IS-IS packets received on that interface.
Default	no protocol-protection
Parameters	<p>allow-sham-links — Allows sham links. As OSPF sham links form an adjacency over the MPLS-VPRN backbone network, when protocol-protection is enabled, the tunneled OSPF packets to be received over the backbone network must be explicitly allowed.</p> <p>block-pim-tunneled — - Blocks extraction and processing of PIM packets arriving at the SR-OS node inside a tunnel (for example, MPLS or GRE) on a network interface. With protocol-protection enabled and tunneled pim blocked, PIM in an mVPN on the egress DR will not switch traffic from the (*,G) to the (S,G) tree.</p>

cpu-protection

Syntax	cpu-protection <i>policy-id</i> no cpu-protection
Context	config>router>interface config>service>ies>interface config>service>ies>video-interface config>service>vpls>video-interface config>service>vprn>interface config>service>vprn>network-interface config>service>vprn>video-interface
Description	<p>Use this command to apply a specific CPU protection policy to the associated interface. For these interface types, the per-source rate limit is not applicable.</p> <p>If no CPU-protection policy is assigned to an interface, then the default policy is used to limit the overall-rate. The default policy is policy number 254 for access interfaces, 255 for network interfaces and no policy for video interfaces.</p> <p>The no form of the command reverts to the default values.</p>
Default	<p>cpu-protection 254 (for access interfaces)</p> <p>cpu-protection 255 (for network interfaces)</p> <p>none (for video-interfaces, shown as no cpu-protection in CLI)</p> <p>The configuration of no cpu-protection returns the interface to the default policies as shown above.</p>

cpu-protection

Syntax	cpu-protection <i>policy-id</i> [<i>mac-monitoring</i>] [<i>ip-src-monitoring</i>] no cpu-protection
---------------	---

CPU Protection Commands

Context	config>subscriber-mgmt>msap-policy
Description	<p>Use this command to apply a specific CPU protection policy to the associated msap-policy. The specified cpu-protection policy will automatically be applied to any MSAPs that are create using the msap-policy.</p> <p>If no CPU-protection policy is assigned to a SAP, then a default policy is used to limit the overall-rate according to the default policy. The default policy is policy number 254 for access interfaces, 255 for network interfaces and no policy for video interfaces.</p> <p>The no form of the command reverts to the default values.</p>
Default	<p>cpu-protection 254 (for access interfaces)</p> <p>cpu-protection 255 (for network interfaces)</p> <p>The configuration of no cpu-protection returns the msap-policy to the default policies as shown above.</p>
Parameters	<p>mac-monitoring — Enables per SAP + source MAC address rate limiting using the per-source-rate from the associated cpu-protection policy.</p> <p>ip-src-monitoring — Enables per SAP + IP source address rate limiting for certain protocol packets using the per-source-rate and included-protocols from the associated cpu-protection policy. The ip-src-monitoring is useful in subscriber management architectures that have routers between the subscriber and the BNG (router). In layer-3 aggregation scenarios all packets from all subscribers behind the same aggregation router will arrive with the same source MAC address and as such the mac-monitoring functionality can not differentiate traffic from different subscribers.</p>

cpu-protection

Syntax	cpu-protection <i>policy-id</i> [mac-monitoring][eth-cfm-monitoring [aggregate][car]] [ip-src-monitoring] no cpu-protection
Context	config>service>ies>interface>sap config>service>ies>interface>spoke-sdp config>service>ies>sub-if>grp-if>sap config>service>vprn>interface>sap config>service>vprn>interface>spoke-sdp config>service>vprn>sub-if>grp-if>sap
Description	<p>Use this command to apply a specific CPU protection policy to the associated msap-policy. The specified cpu-protection policy will automatically be applied to any MSAPs that are create using the msap-policy.</p> <p>If no CPU-protection policy is assigned to a SAP, then a default policy is used to limit the overall-rate according to the default policy. The default policy is policy number 254 for access interfaces, 255 for network interfaces and no policy for video interfaces.</p> <p>The no form of the command reverts to the default values.</p>
Default	cpu-protection 254 (for access interfaces)

cpu-protection 255 (for network interfaces)

The configuration of no cpu-protection returns the msap-policy to the default policies as shown above.

- Parameters**
- mac-monitoring** — Enables per SAP + source MAC address rate limiting using the per-source-rate from the associated cpu-protection policy.
 - ip-src-monitoring** — Enables per SAP + IP source address rate limiting for certain protocol packets using the per-source-rate and include-protocols from the associated cpu-protection policy. The ip-src-monitoring is useful in subscriber management architectures that have routers between the subscriber and the BNG (router). In layer-3 aggregation scenarios all packets from all subscribers behind the same aggregation router will arrive with the same source MAC address and as such the mac-monitoring functionality can not differentiate traffic from different subscribers.
 - eth-cfm-monitoring** — Enables the Ethernet Connectivity Fault Management cpu-protection extensions on the associated SAP/SDP/template.
 - aggregate** — applies the rate limit to the sum of the per-peer packet rates.
 - car** — (Committed Access Rate) Ignores Eth-CFM packets when enforcing overall-rate.

cpu-protection

- Syntax** **cpu-protection** *policy-id* [**mac-monitoring**][**eth-cfm-monitoring** [**aggregate**][**car**]]
no cpu-protection
- Context** config>service>epipe>sap
 config>service>epipe>spoke-sdp
 config>service>ipipe>sap
 config>service>template>vpls-sap-template
 config>service>vpls>mesh-sdp
 config>service>vpls>sap
 config>service>vpls>spoke-sdp
- Description** Use this command to apply a specific CPU protection policy to the associated SAP, SDP or template. If the mac-monitoring keyword is given then per MAC rate limiting should be performed, using the per-source-rate from the associated cpu-protection policy.
- If no CPU-protection policy is assigned to a SAP, then a default policy is used to limit the overall-rate according to the default policy. The default policy is policy number 254 for access interfaces, 255 for network interfaces and no policy for video interfaces.
- The **no** form of the command reverts to the default values.
- Default** cpu-protection 254 (for access interfaces)
 cpu-protection 255 (for network interfaces)
- The configuration of **no cpu-protection** returns the SAP/SDP/template to the default policies as shown above.
- Parameters** **mac-monitoring** — Enables per SAP + source MAC address rate limiting using the per-source-rate from the associated cpu-protection policy.

eth-cfm-monitoring — Enables the Ethernet Connectivity Fault Management cpu-protection extensions on the associated SAP/SDP/template.

aggregate — applies the rate limit to the sum of the per-peer packet rates.

car — (Committed Access Rate) Ignores Eth-CFM packets when enforcing overall-rate.

Distributed CPU Protection Commands

dist-cpu-protection

Syntax	dist-cpu-protection
Context	config>system>security
Description	This command enters the CLI context for configuration of the Distributed CPU Protection (DCP) feature.

policy

Syntax	[no] policy <i>policy-name</i>
Context	config>system>security>dist-cpu-protection
Description	This command configures one of the maximum 16 Distributed CPU Protection policies. These policies can be applied to objects such as SAPs and network interfaces.
Parameters	<i>policy-name</i> — Name of the policy to be configured.

description

Syntax	[no] description <i>string</i>
Context	config>system>security>dist-cpu-protection>policy

rate

Syntax	rate kbps <i>kilobits-per-second max</i> [mbs size] [bytes kilobytes] rate packets <i>{pp max}</i> within <i>seconds</i> [initial-delay packets] no rate
Context	config>system>security>dist-cpu-protection>policy>static-policer config>system>security>dist-cpu-protection>policy>local-monitoring-policer config>system>security>dist-cpu-protection>policy>protocol>dynamic-parameters
Description	This command configures the rate and burst tolerance for the policer in either a packet rate or a bit rate.

The actual hardware may not be able to perfectly rate limit to the exact configured parameters. In this case, the configured parameters will be adapted to the closest supported rate. The actual (operational) parameters can be seen in CLI, for example, “show service id 33 sap 1/1/3:33 dist-cpu-protection detail”.

Default rate packets max within 1

Parameters **packets|kbits** — specifies that the rate is either in units of packets per interval or in units of kilobits-per-second. The packets option would typically be used for lower rates (for example, for per subscriber DHCP rate limiting) while the kbits option would typically be used for higher rates (for example, per interface BGP rate limiting).

ppi — Specifies packets per interval. 0..255 or max (0 = all packets are non-conformant)

- rate of max=effectively disable the policier (always conformant)
- rate of packets 0 = all packets considered non-conformant.

within seconds — Specifies the length of the ppi rate measurement interval.

Values 1..32767

initial-delay packets — The number of packets allowed (even at line rate) in an initial burst (or a burst after the policer bucket has drained to zero) in addition to the normal “ppi”. This would typically be set to a value that is equal to the number of received packets in several full handshakes/negotiations of the particular protocol.

Values 1..255

kbits kilobits-per-second —

Values 1..2000000|max max = This effectively disable the policer (always conformant).

mbs — =The tolerance for the kbits rate

Values 0..4194304. A configured mbs of 0 will cause all packets to be considered non-conformant.

bytes|kilobytes — Specifies that the units of the mbs size parameter are either in bytes or kilobytes.

Default The default mbs sets the mbs to 10ms of the kbits.

detection-time

Syntax **detection-time seconds**

Context config>system>security>dist-cpu-protection>policy>static-policer

Description When a policer is declared as in an “exceed” state, it will remain as exceeding until a contiguous conformant period of **detection-time** passes. The **detection-time** only starts after the exceed-action hold-down is complete. If the policer detects another exceed during the detection count down then a hold-down is once again triggered before the policer re-enters the detection time (that is, the count-down timer starts again at the configured value). During the hold-down (and the detection-time), the policer is considered as in an “exceed” state.

Default 30

Parameters *seconds* — Specifies in seconds.

Values 1..128000

dynamic-enforcement-policer-pool

Syntax **[no] dynamic-enforcement-policer-pool** *number-of-policers*

Context config>dist-cpu-protection

Description This command reserves a set of policers for use as dynamic enforcement policers for the Distributed CPU Protection (DCP) feature. Policers are allocated from this pool and instantiated as per-object-per-protocol dynamic enforcement policers after a local monitor is triggered for an object (such as a SAP or Network Interface). Any change to this configured value automatically clears the high water mark, timestamp, and failed allocation counts as seen under “show card x fp y dist-cpu-protection” and in the `tmnxFpDcpDynEnfrcPlcrStatTable` in the TIMETRA-CHASSIS-MIB. Decreasing this value to below the currently used/allocated number causes all dynamic policers to be returned to the free pool (and traffic returns to the local monitors).

Default 0

Parameters *number-of-policers* — specifies the number of policers to be reserved.

Values 0, 1000..32k

exceed-action

Syntax **exceed-action {discard [hold-down *seconds*] | low-priority [hold-down *seconds*] | none}**

Context config>system>security>dist-cpu-protection>policy>static-policer
config>system>security>dist-cpu-protection>policy>protocol>dynamic-parameters

Description This command controls the action performed upon the extracted control packets when the configured policer rates are exceeded.

Default none

Parameters **discard** — Discards packets that are non-conformant.

low-priority — Marks packets that are non-conformant as low-priority. If there is congestion in the control plane of the SR OS router then unmarked control packets are given preferential treatment.

hold-down *seconds* — (optional) When the parameter is specified, it causes the following “hold-down” behavior.

When SR OS software detects that an enforcement policer has marked or discarded one or more packets (software may detect this some time after the packets are actually discarded), and an optional **hold-down *seconds*** value has been specified for the **exceed-action**, then the policer will be set into a “mark-all” or “drop-all” mode that cause the following:

- the policer state to be updated as normal
- all packets to be marked (if the action is “low-priority”) or dropped (action = discard) regardless of the results of the policing decisions/actions/state.

The **hold-down** is cleared after approximately the configured time in seconds after it was set. The **hold-down seconds** option should be selected for protocols that receive more than one packet in a complete handshake/negotiation (for example, DHCP, PPP). **hold-down** is not applicable to a local monitoring policer. The “detection-time” will only start after any **hold-down** is complete. During the **hold-down** (and the detection-time), the policer is considered as in an “exceed” state. The policer may re-enter the hold-down state if an exceed packet is detected during the detection-time countdown. The allowed values are [none|1..10080|indefinite].

Values 1-10080 in seconds

none — no hold-down

indefinite — hold down is in place until the operator clears it manually using a tools command (tools perform security dist-cpu-protection release-hold-down) or removes the dist-cpu-protection policy from the object.

exceed-action

Syntax	exceed-action {discard low-priority none}
Context	config>system>security>dist-cpu-protection>policy>local-monitoring-policer
Description	This command controls the action performed upon the extracted control packets when the configured policer rates are exceeded.
Default	none
Parameters	discard — Discards packets that are non-conformant. low-priority — Marks packets that are non-conformant as low-priority. If there is congestion in the control plane of the SR OS router then unmarked control packets are given preferential treatment. none — no hold-down

log-events

Syntax	[no] log-events [verbose]
Context	config>system>security>dist-cpu-protection>policy>static-policer
Description	This command controls the creation of log events related to static-policer status and activity.
Default	default = log-events log-events: send the Exceed (Excd) and Conform events (e.g. sapDcpStaticExcd)

Parameters **verbose** — (optional) Sends the same events as just “log-events” plus Hold Down Start and Hold Down End events. The optional “verbose” includes some events that are more likely used during debug/tuning/investigations.

local-monitoring-policer

Syntax **[no] local-monitoring-policer** *policer-name* **[create]**

Context config>system>security>dist-cpu-protection>policy>local-monitoring-policer

Description This command configures a monitoring policier that is used to monitor the aggregate rate of several protocols arriving on an object (for example, SAP). When the **local-monitoring-policer** is determined to be in a non-conformant state (at the end of a minimum monitoring time of 60 seconds) then the system will attempt to allocate dynamic policers for the particular object for any protocols associated with the local monitor (for example, via the “protocol xyz enforcement” CLI command).

If the system cannot allocate all the dynamic policers within 150 seconds, it will stop attempting to allocate dynamic policers, raise a LocMonExcdAllDynAlloc log event, and go back to using the local monitor. The local monitor may then detect exceeded packets again and make another attempt at allocating dynamic policers.

Once this *policer-name* is referenced by a protocol then this policer will be instantiated for each “object” that is created and references this DDoS policy. If there is no policer free then the object will be blocked from being created.

Parameters *policy-name* — Specifies name of the policy.

Values [32 chars max]

log-events

Syntax **[no] log-events** **[verbose]**

Context config>system>security>dist-cpu-protection>policy>local-monitoring-policer

Description This command controls the creation of log events related to **local-monitoring-policer** status and activity.

Default log-events: send the DcpLocMonExcdOutOfDynRes events

Parameters **verbose** — This parameter sends the same events as just “log-events” plus DcpLocMonExcd, DcpLocMonExcdAllDynAlloc, and DcpLocMonExcdAllDynFreed. The optional “verbose” includes some events that are more likely used during debug/tuning/investigations

protocol

Syntax **[no] protocol** *name* **[create]**

Context config>system>security>dist-cpu-protection>policy

Description This command creates the protocol for control in the policy.

Control packets that are both forwarded (which means they could be subject to normal QoS policy policing) and also copied for extraction are not subject to distributed cpu protection (including in the all-unspecified bucket). This includes traffic snooping (for example, PIM in VPLS) as well as control traffic that is flooded in an R-VPLS instance and also extracted to the CPM such as ARP, ISIS and VRRP. Centralized per SAP/interface cpu-protection can be employed to rate limit or mark this traffic if desired.

Explanatory notes for some of the protocols:

- **bfd-cpm:** includes all bfd handled on the CPM including cpm-np type, single hop and multi-hop, and MPLS-TP CC and CV bfd
- **dhcp:** includes dhcp for IPv4 and IPv6
- **eth-cfm:** 802.1ag and includes Y.1731. Eth-cfm packets on port and LAG based facility MEPs are not included (but packets on Tunnel MEPs are).
- **icmp:** includes IPv4 and IPv6 ICMP except Neighbor Discovery which is classified as a separate protocol 'ndis'
- **isis:** includes isis used for SPBM
- **ldp:** includes ldp and t-ldp
- **mpls-ttl:** MPLS packets that are extracted due to an expired mpls ttl field
- **ndis:** IPv6 Neighbor Discovery
- **ospf:** includes all OSPFv2 and OSPFv3 packets.
- **pppoe-pppoa:** includes PADx, LCP, PAP/CHAP and NCPs
- **all-unspecified:** a special 'protocol'. When configured, this treats all extracted control packets that are not explicitly created in the dist-cpu-protection policy as a single aggregate flow (or "virtual protocol"). It lumps together "all the rest of the control traffic" to allow it to be rate limited as one flow. It includes all control traffic of all protocols that are extracted and sent to the CPM (even protocols that cannot be explicitly configured with the distributed cpu protection feature). Control packets that are both forwarded and copied for extraction are not included. If an operator later explicitly configures a protocol, then that protocol is suddenly no longer part of the "all-unspecified" flow. The "all-unspecified" protocol must be explicitly configured in order to operate.

"no protocol x" means packets of protocol x are not monitored and not enforced (although they do count in the fp protocol queue) on the objects to which this dist-cpu-protection policy is assigned, although the packets will be treated as part of the all-unspecified protocol if the all-unspecified protocol is created in the policy.

Default none

Parameters *names* — Signifies protocol name.

Values arp|dhcp|http-redirect|icmp|igmp|mld|ndis|pppoe-pppoa|all-unspecified|mpls-ttl|bfd-cpm|bgp|eth-cfm|isis|ldp|ospf|pim|rsvp.

enforcement

Syntax	enforcement { static <i>policer-name</i> dynamic { <i>mon-policer-name</i> local-mon-bypass }}
Context	config>system>security>dist-cpu-protection>policy>protocols
Description	This command configures the enforcement method for the protocol.
Default	dynamic local-mon-bypass
Parameters	<p>static — the protocol is always enforced using a static-policer. Multiple protocols can reference the same static-policer. Packets of protocols that are statically enforced bypass any local monitors.</p> <p><i>policer name</i> — Specifies the name is a static-policer.</p> <p>dynamic — A specific enforcement policer for this protocol for this SAP/object is instantiated when the associated local-monitoring-policer is determined to be in a non-conformant state (at the end of a minimum monitoring time of 60 seconds to reduce thrashing).</p> <p><i>mon-policer-name</i> — Specifies which local-monitoring-policer to use</p> <p>local-mon-bypass — This parameter is used to not include packets from this protocol in the local monitoring function, and when the local-monitor “trips”, do not instantiate a dynamic enforcement policer for this protocol.</p>

detection-time

Syntax	detection-time <i>seconds</i>
Context	config>system>security>dist-cpu-protection>policy>protocols>dynamic-parameters
Description	When a dynamic enforcing policer is instantiated, it will remain allocated until at least a contiguous conformant period of detection-time passes.

dynamic-parameters

Syntax	dynamic-parameters
Context	config>system>security>dist-cpu-protection>policy>protocols
Description	The dynamic-parameters are used to instantiate a dynamic enforcement policer for the protocol when the associated local-monitoring-policer is considered as exceeding its rate parameters (at the end of a minimum monitoring time of 60 seconds).

log-events

Syntax	[no] log-events [verbose]
Context	config>system>security>dist-cpu-protection>policy>protocols>dynamic-parameters
Description	This command controls the creation of log events related to dynamic enforcement policer status & activity

Distributed CPU Protection Commands

Default log-events - send the Exceed (Excd) and Conform events

Parameters **verbose** — This parameter sends the send the same events as just “log-events” plus Hold Down Start, Hold Down End, DcpDynamicEnforceAlloc and DcpDynamicEnforceFreed events. The optional “verbose” includes the allocation/de-allocation events (typically used for debug/tuning only – could be very noisy even when there is nothing much of concern)

static-policer

Syntax	[no] static-policer policer-name [create]
Context	config>system>security>dist-cpu-protection>policy
Description	Configures a static enforcement policer that can be referenced by one or more protocols in the policy. Once this policer-name is referenced by a protocol, then this policer will be instantiated for each object (e.g. SAP or network interface) that is created and references this policy. If there is no policer resource available on the associated card/fp then the object will be blocked from being created. Multiple protocols can use the same static-policer.
Parameters	<i>policy-name</i> — Specifies the name of the policy.
	Values [32 chars max]

Show Commands

Security Commands

access-group

- Syntax** `access-group [group-name]`
- Context** `show>system>security`
- Description** This command displays SNMP access group information.
- Parameters** *group-name* — This command displays information for the specified access group.
- Output** **Security Access Group Output** — The following table describes security access group output fields..

Table 10: Show System Security Access Group Output Fields

Label	Description
Group name	The access group name.
Security model	The security model required to access the views configured in this node.
Security level	Specifies the required authentication and privacy levels to access the views configured in this node.
Read view	Specifies the variable of the view to read the MIB objects.
Write view	Specifies the variable of the view to configure the contents of the agent.
Notify view	Specifies the variable of the view to send a trap about MIB objects.

Sample Output

```
A:ALA-4# show system security access-group
=====
Access Groups
=====
group name      security  security  read      write      notify
                model    level    view      view      view
-----
snmp-ro        snmpv1   none     no-security          no-security
snmp-ro        snmpv2c  none     no-security          no-security
snmp-rw        snmpv1   none     no-security  no-security  no-security
snmp-rw        snmpv2c  none     no-security  no-security  no-security
snmp-rwa       snmpv1   none     iso          iso          iso
snmp-rwa       snmpv2c  none     iso          iso          iso
```

```
snmp-trap      snmpv1      none          iso
snmp-trap      snmpv2c     none          iso
=====
A:ALA-7#
```

authentication

- Syntax** **authentication [statistics]**
- Context** show>system>security
- Description** This command displays system login authentication configuration and statistics.
- Parameters** **statistics** — Appends login and accounting statistics to the display.
- Output** **Authentication Output** — The following table describes system security authentication output fields.

Table 11: Show System Security Authentication Output Fields

Label	Description
Sequence	The sequence in which authentication is processed.
Server address	The IP address of the RADIUS server.
Status	Current status of the RADIUS server.
Type	The authentication type.
Timeout (secs)	The number of seconds the router waits for a response from a RADIUS server.
Single connection	Enabled — Specifies a single connection to the TACACS+ server and validates everything via that connection. Disabled — The TACACS+ protocol operation is disabled.
Retry count	Displays the number of times the router attempts to contact the RADIUS server for authentication if there are problems communicating with the server.
Connection errors	Displays the number of times a user has attempted to login irrespective of whether the login succeeded or failed.
Accepted logins	The number of times the user has successfully logged in.
Rejected logins	The number of unsuccessful login attempts.
Sent packets	The number of packets sent.
Rejected packets	The number of packets rejected.

Sample Output

```

A:ALA-4# show system security authentication
=====
Authentication                sequence : radius tacplus local
=====
server address  status  type    timeout(secs)  single connection  retry count
-----
10.10.10.103   up      radius  5              n/a                 5
10.10.0.1      up      radius  5              n/a                 5
10.10.0.2      up      radius  5              n/a                 5
10.10.0.3      up      radius  5              n/a                 5
-----
radius admin status : down
tacplus admin status : up
health check        : enabled
-----
No. of Servers: 4
=====
A:ALA-4#

A:ALA-7>show>system>security# authentication statistics
=====
Authentication                sequence : radius tacplus local
=====
server address  status  type    timeout(secs)  single connection  retry count
-----
10.10.10.103   up      radius  5              n/a                 5
10.10.0.1      up      radius  5              n/a                 5
10.10.0.2      up      radius  5              n/a                 5
10.10.0.3      up      radius  5              n/a                 5
-----
radius admin status : down
tacplus admin status : up
health check        : enabled
-----
No. of Servers: 4
=====
Login Statistics
=====
server address  connection errors  accepted logins  rejected logins
-----
10.10.10.103   0                  0                0
10.10.0.1      0                  0                0
10.10.0.2      0                  0                0
10.10.0.3      0                  0                0
local          n/a                1                0
=====
Authorization Statistics (TACACS+)
=====
server address  connection errors  sent packets  rejected packets
-----
Accounting Statistics
=====
server address  connection errors  sent packets  rejected packets
-----
10.10.10.103   0                  0                0

```

Security Commands

```
10.10.0.1          0          0          0
10.10.0.2          0          0          0
10.10.0.3          0          0          0
=====
A:ALA-7#
*A:Dut-C# show system security authentication statistics

=====
Authentication          sequence : radius tacplus local
=====
type                    status  timeout    single    retry
  server address              (secs)    conn     count
-----
health check           : enabled (interval 30)

=====
Login Statistics
=====
server address              conn  accepted  rejected
                             errors logins   logins
-----
local                       n/a   4          0

=====
Authorization Statistics (TACACS+)
=====
server address              conn  sent      rejected
                             errors pkts  pkts
-----

=====
Accounting Statistics
=====
server address              conn  sent      rejected
                             errors pkts  pkts
-----
=====
```

communities

- Syntax** **communities**
- Context** show>system>security
- Description** This command displays SNMP communities.
- Output** **Communities Output** — The following table describes community output fields.

Table 12: Show Communities Output Fields

Label	Description
Community	The community string name for SNMPv1 and SNMPv2c access only.
Access	r – The community string allows read-only access. rw – The community string allows read-write access. rwa – The community string allows read-write access. mgmt – The unique SNMP community string assigned to the management router.
View	The view name.
Version	The SNMP version.
Group Name	The access group name.
No of Communities	The total number of configured community strings.

Sample Output

```
A:ALA-48# show system security communities
=====
Communities
=====
community      access  view          version  group name
-----
cli-readonly   r       iso           v2c     cli-readonly
cli-readwrite  rw     iso           v2c     cli-readwrite
public         r       no-security   v1 v2c  snmp-ro
-----
No. of Communities: 3
=====
A:ALA-48#
```

cpm-filter

Syntax	cpm-filter
Context	show>system>security
Description	This command displays CPM filters.

ip-filter

- Syntax** `ip-filter [entry entry-id]`
- Context** `show>system>security>cpm-filter`
- Description** This command displays CPM IP filters.
- Parameters** `entry entry-id` — Identifies a CPM filter entry as configured on this system.
 - Values** 1 — 2048
- Output** **CPM Filter Output** — The following table describes CPM IP filter output fields..

Table 13: Show CPM IP Filter Output Fields

Label	Description
Entry-Id	Displays information about the specified management access filter entry
Dropped	Displays the number of dropped events.
Forwarded	Displays the number of forwarded events.
Description	Displays the CPM filter description.
Log ID	Displays the log ID where matched packets will be logged.
Src IP	Displays the source IP address(/netmask or prefix-list)
Dest. IP	Displays the destination IP address(/netmask).
Src Port	Displays the source port number (range).
Dest. Port	Displays the destination port number (range).
Protocol	Displays the Protocol field in the IP header.
Dscp	Displays the DSCP field in the IP header.
Fragment	Displays the 3-bit fragment flags or 13-bit fragment offset field.
ICMP Type	Displays the ICMP type field in the ICMP header.
ICMP Code	Displays the ICMP code field in the ICMP header.
TCP-syn	Displays the SYN flag in the TCP header.
TCP-ack	Displays the ACK flag in the TCP header
Match action	When the criteria matches, displays drop or forward packet.
Next Hop	In case match action is forward, indicates destination of the matched packet.

Table 13: Show CPM IP Filter Output Fields (Continued)

Label	Description
Dropped pkts	Indicates number of matched dropped packets
Forwarded pkts	Indicates number of matched forwarded packets.

Sample Output

```
A:ALA-35# show system security cpm-filter ip-filter
=====
CPM IP Filters
=====
Entry-Id  Dropped   Forwarded Description
-----
101        25880      0        CPM-Filter 10.4.101.2 #101
102        25880      0        CPM-Filter 10.4.102.2 #102
103        25880      0        CPM-Filter 10.4.103.2 #103
104        25882      0        CPM-Filter 10.4.104.2 #104
105        25926      0        CPM-Filter 10.4.105.2 #105
106        25926      0        CPM-Filter 10.4.106.2 #106
107        25944      0        CPM-Filter 10.4.107.2 #107
108        25950      0        CPM-Filter 10.4.108.2 #108
109        25968      0        CPM-Filter 10.4.109.2 #109
110        25984      0        CPM-Filter 10.4.110.2 #110
111        26000      0        CPM-Filter 10.4.111.2 #111
112        26018      0        CPM-Filter 10.4.112.2 #112
113        26034      0        CPM-Filter 10.4.113.2 #113
114        26050      0        CPM-Filter 10.4.114.2 #114
115        26066      0        CPM-Filter 10.4.115.2 #115
116        26084      0        CPM-Filter 10.4.116.2 #116
=====
A:ALA-35#

A:ALA-35# show system security cpm-filter ip-filter entry 101
=====
CPM IP Filter Entry
=====
Entry Id      : 101
Description   : CPM-Filter 10.4.101.2 #101
-----
Filter Entry Match Criteria :
-----
Log Id        : n/a
Src. IP       : 10.4.101.2/32      Src. Port     : 0
Dest. IP      : 10.4.101.1/32      Dest. Port    : 0
Protocol      : 6                    Dscp          : ef
ICMP Type     : Undefined        ICMP Code     : Undefined
Fragment      : True              Option-present : Off
IP-Option     : 130/255          Multiple Option : True
TCP-syn       : Off              TCP-ack       : True
Match action  : Drop
=====
A:ALA-35#
```

ipv6-filter

- Syntax** `ip-filter [entry entry-id]`
- Context** `show>system>security>cpm-filter`
- Description** Displays CPM IPv6 filters.
- Parameters** `entry entry-id` — Identifies a CPM IPv6 filter entry as configured on this system.
- Values** 1 — 2048
- Output** **CPM Filter Output** — The following table describes CPM IPv6 filter output fields..

Table 14: Show CPM IPv6 Filter Output Fields

Label	Description
Entry-Id	Displays information about the specified management access filter entry
Dropped	Displays the number of dropped events.
Forwarded	Displays the number of forwarded events.
Description	Displays the CPM filter description.
Log ID	Log Id where matched packets will be logged.
Src IP	Displays Source IP address(/netmask)
Dest. IP	Displays Destination IP address(/netmask).
Src Port	Displays Source Port Number (range).
Dest. Port	Displays Destination Port Number (range).
next-header	Displays next-header field in the IPv6 header.
Dscp	Displays Traffic Class field in the IPv6 header.
ICMP Type	Displays ICMP type field in the icmp header.
ICMP Code	Displays ICMP code field in the icmp header.
TCP-syn	Displays the SYN flag in the TCP header.
TCP-ack	Displays the ACK flag in the TCP header
Match action	When criteria matches, displays drop or forward packet.
Next Hop	In case match action is forward, indicates destination of the matched packet.
Dropped pkts	Indicating number of matched dropped packets
Forwarded pkts	Indicating number of matched forwarded packets.

Sample Output

```

A:ALA-35# show system security cpm-filter ipv6-filter
=====
CPM IPv6 Filters
=====
Entry-Id Dropped Forwarded Description
-----
101      25880    0          CPM-Filter 11::101:2 #101
102      25880    0          CPM-Filter 11::102:2 #102
103      25880    0          CPM-Filter 11::103:2 #103
104      25880    0          CPM-Filter 11::104:2 #104
105      25880    0          CPM-Filter 11::105:2 #105
106      25880    0          CPM-Filter 11::106:2 #106
107      25880    0          CPM-Filter 11::107:2 #107
108      25880    0          CPM-Filter 11::108:2 #108
109      25880    0          CPM-Filter 11::109:2 #109
=====
A:ALA-35#

A:ALA-35# show system security cpm-filter ipv6-filter entry 101
=====
CPM IPv6 Filter Entry
=====
Entry Id : 1
Description : CPM-Filter 11::101:2 #101
-----
Filter Entry Match Criteria :
-----
Log Id : n/a
Src. IP : 11::101:2          Src. Port : 0
Dest. IP : 11::101:1        Dest. Port : 0
next-header : none          Dscp : Undefined
ICMP Type : Undefined       ICMP Code : Undefined
TCP-syn : Off               TCP-ack : Off
Match action : Drop
Dropped pkts : 25880        Forwarded pkts : 0
=====
A:ALA-35#

```

cpm-queue

Syntax	cpm-queue <i>queue-id</i>
Context	show>system>security
Description	Displays CPM queues.
Parameters	<i>queue-id</i> — Specifies an integer value that identifies a CPM queue.
Values	0, 33 — 2000

CPM queue Output — The following table describes CPM queue output fields..

Table 15: Show CPM IPv6 Filter Output Fields

Label	Description
PIR	Displays the administrative Peak Information Rate (PIR) for the queue.
CIR	Displays the amount of bandwidth committed to the queue.
CBS	Displays the amount of buffer drawn from the reserved buffer portion of the queue's buffer pool.
MBS	Displays the maximum queue depth to which a queue can grow.

Sample Output

```
A:ALA-35# show system security cpm-queue 1001
=====
CPM Queue Entry
=====
Queue Id           : 1001
-----
Queue Parameters :
-----
PIR                : 10000000          CIR                : 10000000
CBS                : 4096             MBS                : 8192
=====
A:ALA-35#
```

cpu-protection

- Syntax** **cpu-protection**
- Context** show>system>security
- Description** This command enables the context to display CPU protection information.

Sample Output

```
show system security cpu-protection eth-cfm-monitoring
=====
SAP's where the protection policy Eth-CFM rate limit is exceeded
=====
SAP-Id                Service-Id   Plcy
-----
1/1/1                 3           100
-----
1 SAP('s) found
=====
SDP's where the protection policy Eth-CFM rate limit is exceeded
=====
```

```
SDP-Id          Service-Id  Plcy
-----
1:3             3           100
-----
```

```
1 SDP('s) found
=====
```

```
show system security cpu-protection eth-cfm-monitoring service-id 3 sap-id 1/1/1
=====
```

```
Flows exceeding the Eth-CFM monitoring rate limit
=====
```

```
Service-Id : 3
SAP-Id     : 1/1/1
Plcy       : 100
-----
```

Limit	MAC-Address	Level	OpCode	Violation-Periods
	First-Time	Last-Time		
0	8c:8c:8c:8c:8c:8c	1	18	
	03/21/2009 23:32:29	03/21/2009 23:34:39		4000000019
61234	8d:8d:8d:8d:8d:8d	2	19	
	03/21/2009 23:32:39	03/21/2009 23:34:59		4000000020
61234	Aggregated	3	20	
	03/21/2009 23:32:49	03/21/2009 23:35:19		4000000021
61234	8f:8f:8f:8f:8f:8f	4	21	
	03/21/2009 23:32:59	03/21/2009 23:35:39		4000000022
61234	90:90:90:90:90:90	5	22	
	03/21/2009 23:33:09	03/21/2009 23:35:59		4000000023
61234	91:91:91:91:91:91	6	23	
	03/21/2009 23:33:19	03/21/2009 23:36:19		4000000024
61234	92:92:92:92:92:92	7	24	
	03/21/2009 23:33:29	03/21/2009 23:36:39		4000000025
max	Aggregated	0	25	
	03/21/2009 23:33:39	03/21/2009 23:36:59		4000000026
0	94:94:94:94:94:94	1	26	
	03/21/2009 23:33:49	03/21/2009 23:37:19		4000000027

```
9 flows(s) found
=====
```

```
show system security cpu-protection eth-cfm-monitoring service-id 3 sdp-id 1:3
=====
```

```
Flows exceeding the Eth-CFM monitoring rate limit
=====
```

```
Service-Id : 3
SDP-Id     : 1:3
Plcy       : 100
-----
```

Limit	MAC-Address	Level	OpCode	Violation-Periods
	First-Time	Last-Time		
0	8c:8c:8c:8c:8c:8c	1	18	
	03/21/2009 23:32:29	03/21/2009 23:34:39		3000000019
61234	8d:8d:8d:8d:8d:8d	2	19	
	03/21/2009 23:32:39	03/21/2009 23:34:59		3000000020
61234	Aggregated	3	20	
	03/21/2009 23:32:49	03/21/2009 23:35:19		3000000021
61234	8f:8f:8f:8f:8f:8f	4	21	
	03/21/2009 23:32:59	03/21/2009 23:35:39		3000000022

Security Commands

```
61234 90:90:90:90:90:90 5 22
03/21/2009 23:33:09 03/21/2009 23:35:59 3000000023
61234 91:91:91:91:91:91 6 23
03/21/2009 23:33:19 03/21/2009 23:36:19 3000000024
61234 92:92:92:92:92:92 7 24
03/21/2009 23:33:29 03/21/2009 23:36:39 3000000025
max Aggregated 0 25
03/21/2009 23:33:39 03/21/2009 23:36:59 3000000026
0 94:94:94:94:94:94 1 26
03/21/2009 23:33:49 03/21/2009 23:37:19 3000000027
```

9 flow(s) found
=====

```
show system security cpu-protection excessive-sources service-id 3 sdp-id 1:3
```

Sources exceeding the per-source rate limit
=====

```
Service-Id : 3
SDP-Id      : 1:3
Plcy       : 100
Limit      : 65534
```

MAC-Address First-Time Last-Time Violation-Periods

00:00:00:00:00:01 03/22/2009 00:41:59 03/22/2009 01:53:39 3000000043
00:00:00:00:00:02 03/22/2009 00:43:39 03/22/2009 01:56:59 3000000044
00:00:00:00:00:03 03/22/2009 00:45:19 03/22/2009 02:00:19 3000000045
00:00:00:00:00:04 03/22/2009 00:46:59 03/22/2009 02:03:39 3000000046
00:00:00:00:00:05 03/22/2009 00:48:39 03/22/2009 02:06:59 3000000047

5 source(s) found
=====

```
show system security cpu-protection violators sdp
```

SDP's where the protection policy overall rate limit is violated
=====

```
SDP-Id            Service-Id
Plcy Limit First-Time            Last-Time            Violation-Periods
-----
1:1                    3
100 61234 05/01/2010 01:43:53 06/27/2010 22:37:20 3000000007
1:2                    3
255 max 05/01/2010 01:43:55 06/27/2010 22:37:23 3000000008
1:3                    3
100 61234 05/01/2010 01:43:57 06/27/2010 22:37:26 3000000009
1:4                    3
255 max 05/01/2010 01:43:59 06/27/2010 22:37:29 3000000010
1:5                    3
100 61234 05/01/2010 01:44:01 06/27/2010 22:37:32 3000000011
```

5 SDP('s) found
=====

```
show system security cpu-protection excessive-sources
```



```

=====
SAP's where the protection policy per-source rate limit is exceeded
=====
SAP-Id                               Service-Id
  Plcy Limit
-----
1/1/1                                 3
  100 65534
-----
1 SAP('s) found
=====
SDP's where the protection policy per-source rate limit is exceeded
=====
SDP-Id          Service-Id  Plcy  Limit
-----
1:3             3           100   65534
1:4             3           255   max
1:5             3           100   65534
-----
3 SDP('s) found
=====

show system security cpu-protection policy association
=====
Associations for CPU Protection policy 100
=====
Description : (Not Specified)
SAP associations
-----
Service Id   : 3                               Type   : VPLS
  SAP 1/1/1   mac-monitoring
  SAP 1/1/2   eth-cfm-monitoring aggr car
  SAP 1/1/3   eth-cfm-monitoring
  SAP 1/1/4
-----
Number of SAP's : 4
SDP associations
-----
Service Id   : 3                               Type   : VPLS
  SDP 1:1     eth-cfm-monitoring aggr car
  SDP 1:3     eth-cfm-monitoring aggr
  SDP 1:5     mac-monitoring
  SDP 17407:4123456789 eth-cfm-monitoring car
-----
Number of SDP's : 4
Interface associations
-----
None
Managed SAP associations
-----
None
Video-Interface associations
-----
None
=====
Associations for CPU Protection policy 254
=====
Description : Default (Modifiable) CPU-Protection Policy assigned to Access

```

Interfaces

```
SAP associations
-----
None
SDP associations
-----
None
Interface associations
-----
Router-Name : Base
  ies6If
Router-Name : vprn7
  vprn7If
-----
Number of interfaces : 2
Managed SAP associations
-----
None
Video-Interface associations
-----
None
=====
Associations for CPU Protection policy 255
=====
Description : Default (Modifiable) CPU-Protection Policy assigned to Network
              Interfaces

SAP associations
-----
None
SDP associations
-----
Service Id : 3                               Type : VPLS
  SDP 1:2
  SDP 1:4          eth-cfm-monitoring
Service Id : 6                               Type : IES
  SDP 1:6
Service Id : 7                               Type : VPRN
  SDP 1:7
Service Id : 9                               Type : Epipe
  SDP 1:9
Service Id : 300                             Type : VPLS
  SDP 1:300
-----
Number of SDP's : 6
Interface associations
-----
Router-Name : Base
  system
-----
Number of interfaces : 1
Managed SAP associations
-----
None
Video-Interface associations
-----
None
=====
```

```

show system security cpu-protection policy 100 association
=====
Associations for CPU Protection policy 100
=====
Description : (Not Specified)

SAP associations
-----
Service Id : 3                               Type : VPLS
  SAP 1/1/1                                   mac-monitoring
  SAP 1/1/2                                   eth-cfm-monitoring aggr car
  SAP 1/1/3                                   eth-cfm-monitoring
  SAP 1/1/4
-----
Number of SAP's : 4
SDP associations
-----
Service Id : 3                               Type : VPLS
  SDP 1:1                                     eth-cfm-monitoring aggr car
  SDP 1:3                                     eth-cfm-monitoring aggr
  SDP 1:5                                     mac-monitoring
  SDP 17407:4123456789                       eth-cfm-monitoring car
-----
Number of SDP's : 4
Interface associations
-----
None
Managed SAP associations
-----
None
Video-Interface associations
-----
None
=====
A:bksim130#

show system security cpu-protection violators
=====
Ports where a rate limit is violated
=====
Port-Id
  Type Limit First-Time           Last-Time           Violation-Periods
-----
No ports found
=====
Interfaces where the protection policy overall rate limit is violated
=====
Interface-Name                    Router-Name
  Plcy Limit First-Time           Last-Time           Violation-Periods
-----
No interfaces found
=====
SAP's where the protection policy overall rate limit is violated
=====
SAP-Id                             Service-Id
  Plcy Limit First-Time           Last-Time           Violation-Periods

```

Security Commands

```
-----
1/1/1
  100 61234 05/01/2010 01:43:41 06/27/2010 22:37:02 3000000001
-----
1 SAP('s) found
=====
SDP's where the protection policy overall rate limit is violated
=====
SDP-Id          Service-Id
  Plcy Limit First-Time          Last-Time          Violation-Periods
-----
1:1
  100 61234 05/01/2010 01:43:41 06/27/2010 22:37:02 3000000001
1:2
  255 max 05/01/2010 01:43:43 06/27/2010 22:37:05 3000000002
1:3
  100 61234 05/01/2010 01:43:45 06/27/2010 22:37:08 3000000003
1:4
  255 max 05/01/2010 01:43:47 06/27/2010 22:37:11 3000000004
1:5
  100 61234 05/01/2010 01:43:49 06/27/2010 22:37:14 3000000005
-----
5 SDP('s) found
=====
Video clients where the protection policy per-source rate limit is violated
=====
Client IP Address Video-Interface          Service-Id
  Plcy Limit First-Time          Last-Time          Violation-Periods
-----
No clients found
=====
```

eth-cfm-monitoring

- Syntax** `eth-cfm-monitoring [{service-id service-id sap-id sap-id} | {service-id service-id sdp-id sdp-id:vc-id}]`
- Context** `show>system>security>cpu-protection`
- Description** This command displays sources exceeding their eth-cfm-monitoring rate limit.

dist-cpu-protection

- Syntax** `dist-cpu-protection`
- Context** `show>card>fp`
- Description** This command displays Distributed CPU Protection parameters and status at the per card and forwarding plane level.

Output

Table 16: Show Distributed CPU Protection Output Fields

Label	Description
Card	The card identifier
Forwarding Plane (FP)	Identifies the instance of the FP (FastPath) chipset. Some cards have a single FP (for example, an IOM3-XP) and some cards can contain multiple FPs (for example, an IOM2 has two FPs and an XCM can house two FPs via its two XMAAs).
Dynamic Enforcement Policer Pool	The configured size of the dynamic-enforcement-policer-pool for this card/FP.
Dynamic-Policers Currently In Use	The number of policers from the dynamic enforcement policer pool that are currently in use. The policers are allocated from the pool and instantiated as per-object-per-protocol dynamic enforcement policers after a local monitor triggered for an object (such as a SAP or Network Interface).
Hi-WaterMark Hit Count	The maximum Currently In Use value since it was last cleared (clear card x fp y dist-cpu-protection)
Hi-WaterMark Hit Time	The time at which the current Hi-WaterMark Hit Count was first recorded.
Dynamic-Policers Allocation Fail Count	Indicates how many times the system attempted to allocate dynamic enforcement policers but could not get enough the fill the request.

```
*A:nodeA# show card 1 fp 1 dist-cpu-protection
```

```
=====
Card : 1 Forwarding Plane (FP) : 1
=====
```

```
Dynamic Enforcement Policer Pool : 2000
-----
```

```
-----
Statistics Information
-----
```

```
Dynamic-Policers Currently In Use      : 48
Hi-WaterMark Hit Count                 : 72
Hi-WaterMark Hit Time                  : 01/03/2013 15:08:42 UTC
Dynamic-Policers Allocation Fail Count : 0
-----
=====
```

dist-cpu-protection

Syntax	dist-cpu-protection [detail]
Context	show>service>id>sap
Description	This command displays Distributed CPU Protection parameters and status at the per SAP level.
Parameters	detail — Include the adapted operational rate parameters in the CLI output. The adapted Oper. parameters are only applicable if the policer is instantiated (for example, if the associated forwarding plane is operational, or for an interface if there is a physical port configured for the interface, or if the dynamic policers are allocated), otherwise values of 0 kbps, etc are displayed.
Output	Distributed CPU Protection Policer Output — The following table describes Distributed CPU Protection Policer Output output fields.

Table 17: Show Distributed CPU Protection Policer Output Fields

Label	Description
Distributed CPU Protection Policy	The DCP policy assigned to the object.
Policer-Name	The configured name of the static policer
Card/FP	The card and FP identifier. FP identifies the instance of the FP (FastPath) chipset. Some cards have a single FP (for example, IOM3-XP) and some cards can contain multiple FPs (for example, an IOM2 has two FPs and an XCM can house two FPs via its two XMA's).
Policer-State	The state of the policer with the following potential values: <i>Exceed</i> - The policer has been detected as non-conformant to the associated DCP policy parameters (e.g. packets exceeded the configured rate and the DCP polling process identified this occurrence) <i>Conform</i> - The policer has been detected as conformant to the associated DCP policy parameters (rate) <i>not-applicable</i> - Newly created policers or policers that are not currently instantiated. This includes policers configured on linecards that are not in service.
Protocols Mapped	A list of protocols that are configured to map to the particular policer.

Table 17: Show Distributed CPU Protection Policer Output Fields (Continued)

Label	Description
Oper. xyz fields	<p>The actual hardware may not be able to perfectly rate limit to the exact configured rate parameters in a DCP policy. In this case the configured rate parameters will be adapted to the closest supported rate. These adapted operational values are displayed in CLI when the “detail” keyword is included in the show command. The adapted Oper. parameters are only applicable if the policer is instantiated (e.g. if the associated forwarding plane is operational, or for an interface if there is a physical port configured for the interface, or if the dynamic policers are allocated), otherwise values of 0 kbps, etc are displayed.</p> <p><i>Oper. Kbps</i> - The adapted ‘kilobits-per-second’ value for DCP ‘kbps’ rates</p> <p><i>Oper. MBS</i> - The adapted ‘mbs size’ value for DCP ‘kbps’ rates</p> <p><i>Oper. Depth</i> - The calculated policer bucket depth in packets (for DCP ‘packets’ rates) or in bytes (for DCP ‘kbps’ rates)</p> <p><i>Oper. Packets</i> - The adapted ‘ppi’ value for DCP ‘packets’ rates</p> <p><i>Oper. Within</i> - The adapted ‘within seconds’ value for DCP ‘packets’ rates</p> <p><i>Oper. Init. Delay</i> - The adapted ‘initial-delay packets’ value for DCP ‘packets’ rates</p>
Exceed-Count	<p>The count of packets exceeding the policing parameters since the given policer was previously declared as conformant or newly instantiated. This counter has the same behavior as the exceed counter in the DCP the log events – they are baselined (reset) when the policer transitions to conformant.</p>
Detec. Time Remain	<p>The remaining time in the detection-time countdown during which a policer in the exceed state is being monitored to see if it is once again conformant.</p>
Hold-Down Remain	<p>The remaining time in the hold-down countdown during which a policer is treating all packets as exceeding.</p>
All Dyn-Plcr Alloc.	<p>Indicates that all the dynamic enforcement policers have been allocated and instantiated for a given local-monitor.</p>
Dyn-Policer Alloc.	<p>Indicates that a dynamic policer has been instantiated.</p>

Sample Output

```
*A:nodeA# show service id 33 sap 1/1/3:33 dist-cpu-protection detail

=====
Service Access Points(SAP) 1/1/3:33
=====
Distributed CPU Protection Policy : test1

-----
Statistics/Policer-State Information
=====
-----
Static Policer
-----
Policer-Name      : arp
Card/FP           : 1/1                Policer-State      : Conform
Protocols Mapped  : arp
Exceed-Count      : 0
Detec. Time Remain : 0 seconds          Hold-Down Remain.  : none
Operational (adapted) rate parameters:
  Oper. Packets   : 5 ppi                Oper. Within       : 8 seconds
  Oper. Initial Delay: 6 packets
  Oper. Depth     : 0 packets

Policer-Name      : dhcp
Card/FP           : 1/1                Policer-State      : Conform
Protocols Mapped  : dhcp
Exceed-Count      : 0
Detec. Time Remain : 0 seconds          Hold-Down Remain.  : none
Operational (adapted) rate parameters:
  Oper. Kbps      : 2343 kbps            Oper. MBS          : 240 kilobytes
  Oper. Depth     : 0 bytes

... (snip)

*A:nodaA# show service id 33 sap 1/1/3:34 dist-cpu-protection detail

=====
Service Access Points(SAP) 1/1/3:34
=====
Distributed CPU Protection Policy : test2

-----
Statistics/Policer-State Information
=====
-----
Static Policer
-----
No entries found

-----
Local-Monitoring Policer
-----
Policer-Name      : my-local-mon1
Card/FP           : 1/1                Policer-State      : conform
Protocols Mapped  : arp, pppoe-pppoa
```



```

Exceed-Count          : 0
All Dyn-Plcr Alloc.  : False
Operational (adapted) rate parameters:
  Oper. Packets       : 10 ppi           Oper. Within       : 8 seconds
  Oper. Initial Delay : 8 packets
  Oper. Depth         : 0 packets
-----
Dynamic-Policer (Protocol)
-----
Protocol (Dyn-Plcr)  : arp
Card/FP              : 1/1              Protocol-State     : not-applicable
Exceed-Count         : 0
Detec. Time Remain  : 0 seconds         Hold-Down Remain. : none
Dyn-Policer Alloc.  : False
Operational (adapted) rate parameters: unknown

Protocol (Dyn-Plcr)  : pppoe-pppoa
Card/FP              : 1/1              Protocol-State     : not-applicable
Exceed-Count         : 0
Detec. Time Remain  : 0 seconds         Hold-Down Remain. : none
Dyn-Policer Alloc.  : False
Operational (adapted) rate parameters: unknown
-----

```

dist-cpu-protection

Syntax	dist-cpu-protection [detail]
Context	show>router>interface
Description	This command displays Distributed CPU Protection parameters and status at the router Interface level.
Parameters	detail — Include the adapted operational rate parameters in the CLI output. The adapted Oper. parameters are only applicable if the policer is instantiated (for example, if the associated forwarding plane is operational, or for an interface if there is a physical port configured for the interface, or if the dynamic policers are allocated), otherwise values of 0 kbps, etc are displayed.
Output	Distributed CPU Protection Policer Output — The following table describes Distributed CPU Protection Policer Output output fields.

Table 18: Show Distributed CPU Protection Policer Output Fields

Label	Description
Distributed CPU Protection Policy	The DCP policy assigned to the object.
Policer-Name	The configured name of the static policer

Table 18: Show Distributed CPU Protection Policer Output Fields (Continued)

Label	Description
Card/FP	<p>The card and FP identifier. FP identifies the instance of the FP (FastPath) chipset. Some cards have a single FP (for example, IOM3-XP) and some cards can contain multiple FPs (for example, an IOM2 has two FPs and an XCM can house two FPs via its two XMAS).</p>
Policer-State	<p>The state of the policer with the following potential values:</p> <p><i>Exceed</i> - The policer has been detected as non-conformant to the associated DCP policy parameters (e.g. packets exceeded the configured rate and the DCP polling process identified this occurrence)</p> <p><i>Conform</i> - The policer has been detected as conformant to the associated DCP policy parameters (rate)</p> <p><i>not-applicable</i> - Newly created policers or policers that are not currently instantiated. This includes policers configured on linecards that are not in service.</p>
Protocols Mapped	<p>A list of protocols that are configured to map to the particular policer.</p>
Oper. xyz fields	<p>The actual hardware may not be able to perfectly rate limit to the exact configured rate parameters in a DCP policy. In this case the configured rate parameters will be adapted to the closest supported rate. These adapted operational values are displayed in CLI when the “detail” keyword is included in the show command. The adapted Oper. parameters are only applicable if the policer is instantiated (e.g. if the associated forwarding plane is operational, or for an interface if there is a physical port configured for the interface, or if the dynamic policers are allocated), otherwise values of 0 kbps, etc are displayed.</p> <p><i>Oper. Kbps</i> - The adapted ‘kilobits-per-second’ value for DCP ‘kbps’ rates</p> <p><i>Oper. MBS</i> - The adapted ‘mbs size’ value for DCP ‘kbps’ rates</p> <p><i>Oper. Depth</i> - The calculated policer bucket depth in packets (for DCP ‘packets’ rates) or in bytes (for DCP ‘kbps’ rates)</p> <p><i>Oper. Packets</i> - The adapted ‘ppi’ value for DCP ‘packets’ rates</p> <p><i>Oper. Within</i> - The adapted ‘within seconds’ value for DCP ‘packets’ rates</p> <p><i>Oper. Init. Delay</i> - The adapted ‘initial-delay packets’ value for DCP ‘packets’ rates</p>

Table 18: Show Distributed CPU Protection Policer Output Fields (Continued)

Label	Description
Exceed-Count	The count of packets exceeding the policing parameters since the given policer was previously declared as conformant or newly instantiated. This counter has the same behavior as the exceed counter in the DCP the log events – they are baselined (reset) when the policer transitions to conformant.
Detec. Time Remain	The remaining time in the detection-time countdown during which a policer in the exceed state is being monitored to see if it is once again conformant.
Hold-Down Remain	The remaining time in the hold-down countdown during which a policer is treating all packets as exceeding.
All Dyn-Plcr Alloc.	Indicates that all the dynamic enforcement policers have been allocated and instantiated for a given local-monitor.
Dyn-Policer Alloc.	Indicates that a dynamic policer has been instantiated.

Sample Output

```
*A:Dut-A# show router interface "test" dist-cpu-protection detail

=====
Interface "test" (Router: Base)
=====
Distributed CPU Protection Policy : dcpuPol

-----
Statistics/Policer-State Information
=====
-----
Static Policer
-----
Policer-Name      : staticArpPolicer
Card/FP          : 4/1                Policer-State      : Exceed
Protocols Mapped : arp
Exceed-Count     : 10275218
Detec. Time Remain : 29 seconds        Hold-Down Remain.  : none
Operational (adapted) Rate Parameters:
Oper. Packets    : 100 ppi            Oper. Within       : 1 seconds
Oper. Initial Delay: none
Oper. Depth      : 100 packets
-----
-----
Local-Monitoring Policer
-----
```

Security Commands

```
Policer-Name      : localMonitor
Card/FP          : 4/1                Policer-State    : Exceed
Protocols Mapped : icmp, ospf
Exceed-Count     : 8019857
All Dyn-Plcr Alloc. : True
Operational (adapted) Rate Parameters:
  Oper. Packets   : 200 ppi           Oper. Within     : 1 seconds
  Oper. Initial Delay: none
  Oper. Depth     : 0 packets
-----
Dynamic-Policer (Protocol)
-----
Protocol (Dyn-Plcr) : icmp
Card/FP            : 4/1                Protocol-State   : Exceed
Exceed-Count       : 1948137
Detec. Time Remain : 29 seconds        Hold-Down Remain. : none
Dyn-Policer Alloc. : True
Operational (adapted) Rate Parameters:
  Oper. Kbps      : 25 kbps           Oper. MBS       : 256 bytes
  Oper. Depth     : 274 bytes
-----
Protocol (Dyn-Plcr) : ospf
Card/FP            : 4/1                Protocol-State   : Exceed
Exceed-Count       : 1487737
Detec. Time Remain : 29 seconds        Hold-Down Remain. : none
Dyn-Policer Alloc. : True
Operational (adapted) Rate Parameters:
  Oper. Kbps      : 25 kbps           Oper. MBS       : 256 bytes
  Oper. Depth     : 284 bytes
-----
=====
```

excessive-sources

- Syntax** `excessive-sources [service-id service-id sap-id sap-id]`
- Context** `show>system>security>cpu-protection`
- Description** This command displays sources exceeding their per-source rate limit.
- Parameters** `service-id service-id` — Displays information for services exceeding their per-source rate limit.
`sap-id sap-id` — Displays information for SAPs exceeding their per-source rate limit.

policy

- Syntax** **policy** [*policy-id*] **association**
- Context** show>system>security>cpu-protection
show>system>security>dist-cpu-protection
- Description** This command displays CPU protection policy information.
- Parameters** *policy-id* — Displays CPU protection policy information for the specified policy ID>
association — This keyword displays policy-id associations.

protocol-protection

- Syntax** **protocol-protection**
- Context** show>system>security>cpu-protection
- Description** This command display all interfaces with non-zero drop counters.

violators

- Syntax** **violators** [**port**] [**interface**] [**sap**] [**video**] [**sdp**]
- Context** show>system>security>cpu-protection
- Description** This command displays all interfaces, ports or SAPs with CPU protection policy violators. It also includes objects (saps, interfaces) that exceed the out-profile-rate and have the log-events keyword enabled for the out-profile-rate in the cpu-protection policy associated with the object.
- Parameters** **port** — Displays violators associated with the port.
interface — Displays violators associated with the interface.
sap — Displays violators associated with the SAP.
video — Displays violators associated with the video entity.
sdp — Displays violators associated with the SDP.

Sample Output

```
*A:SecuritySR7>config>sys>security>cpu-protection>policy# show system security cpu-
protection violators
=====
Ports where a rate limit is violated
=====
Port-Id
  Type Limit First-Time          Last-Time          Violation-Periods
-----
No ports found
```

```

=====
Interfaces where the protection policy overall rate limit is violated
=====
Interface-Name          Router-Name
  Plcy Limit First-Time      Last-Time      Violation-Periods
-----
toIxia                  Base
  255 1000 10/02/2012 18:38:23 10/02/2012 18:39:31 70
-----
1 interface(s) found
=====

SAP's where the protection policy overall rate limit is violated
=====
SAP-Id                  Service-Id
  Plcy Limit First-Time      Last-Time      Violation-Periods
-----
No SAP's found
=====

SDP's where the protection policy overall rate limit is violated
=====
SDP-Id          Service-Id
  Plcy Limit First-Time      Last-Time      Violation-Periods
-----
No SDP's found
=====

Video clients where the protection policy per-source rate limit is violated
=====
Client IP Address  Video-Interface      Service-Id
  Plcy Limit First-Time      Last-Time      Violation-Periods
-----
No clients found
=====

```

mac-filter

- Syntax** **mac-filter** [**entry** *entry-id*]
- Context** show>system>security>cpm-filter
- Description** This command displays CPM MAC filters.
- Parameters** **entry** *entry-id* — Displays information about the specified entry.
 - Values** 1 — 2048

Sample Output

```
*B:bksim67# show system security cpm-filter mac-filter
=====
CPM Mac Filter (applied)
=====
Entry-Id  Dropped   Forwarded Description
-----
1          23002     47094
-----
Num CPM Mac filter entries: 1
=====
*B:bksim67#
```

mac-filter

- Syntax** **mac-filter** [**entry** *entry-id*]
- Context** show>system>security>management-access-filter
- Description** This command displays management access MAC filters.
- Parameters** **entry** *entry-id* — Displays information about the specified entry.
- Values** 1 — 9999

Sample Output

```
*B:bksim67# show system security management-access-filter mac-filter
=====
Mac Management Access Filter
=====
filter type      : mac
Def. Action      : permit
Admin Status     : enabled (no shutdown)
-----
Entry            : 1                Action           : deny
FrameType        : ethernet_II      Svc-Id           : Undefined
Src Mac          : Undefined
Dest Mac         : Undefined
Dot1p            : Undefined        Ethertype        : Disabled
DSAP             : Undefined        SSAP             : Undefined
Snap-pid        : Undefined        ESnap-oui-zero   : Undefined
cfm-opcode       : Undefined
Log              : disabled         Matches          : 0
=====
*B:bksim67#
```

keychain

Syntax	keychain [<i>key-chain</i>] [detail]
Context	show>system>security
Description	This command displays keychain information.
Parameters	<i>key-chain</i> — Specifies the keychain name to display. detail — Displays detailed keychain information.

Sample Output

```
*A:ALA-A# show system security keychain test
=====
Key chain:test
=====
TCP-Option number send      : 254                Admin state   : Up
TCP-Option number receive   : 254                Oper state    : Up
=====
*A:ALA-A#
*A:ALA-A# show system security keychain test detail
=====
Key chain:test
=====
TCP-Option number send      : 254                Admin state   : Up
TCP-Option number receive   : 254                Oper state    : Up
=====
Key entries for key chain: test
=====
Id          : 0
Direction  : send-receive      Algorithm     : hmac-sha-1-96
Admin State : Up                    Valid        : Yes
Active     : Yes               Tolerance    : 300
Begin Time  : 2007/02/15 18:28:37 Begin Time (UTC) : 2007/02/15 17:28:37
End Time   : N/A              End Time (UTC)  : N/A
=====
Id          : 1
Direction  : send-receive      Algorithm     : aes-128-cmac-96
Admin State : Up                    Valid        : Yes
Active     : No               Tolerance    : 300
Begin Time  : 2007/02/15 18:27:57 Begin Time (UTC) : 2007/02/15 17:27:57
End Time   : 2007/02/15 18:28:13 End Time (UTC)  : 2007/02/15 17:28:13
=====
Id          : 2
Direction  : send-receive      Algorithm     : aes-128-cmac-96
Admin State : Up                    Valid        : Yes
Active     : No               Tolerance    : 500
Begin Time  : 2007/02/15 18:28:13 Begin Time (UTC) : 2007/02/15 17:28:13
End Time   : 2007/02/15 18:28:37 End Time (UTC)  : 2007/02/15 17:28:37
=====
*A:ALA-A#
```

management-access-filter

- Syntax** `management-access-filter`
- Context** `show>system>security`
- Description** This command displays management access filter information for IP and MAC filters.

ip-filter

- Syntax** `ip-filter [entry entry-id]`
- Context** `show>system>security>mgmt-access-filter`
- Description** This command displays management-access IP filters.
- Parameters** *entry-id* — Displays information for the specified entry.
- Values** 1 — 9999
- Output** **Management Access Filter Output** — The following table describes management access filter output fields.

Table 19: Show Management Access Filter Output Fields

Label	Description
Def. action	<p>Permit — Specifies that packets not matching the configured selection criteria in any of the filter entries are permitted.</p> <p>Deny — Specifies that packets not matching the configured selection criteria in any of the filter entries are denied and that a ICMP host unreachable message will be issued.</p> <p>Deny-host-unreachable — Specifies that packets not matching the configured selection criteria in the filter entries are denied.</p>
Entry	The entry ID in a policy or filter table.
Description	A text string describing the filter.
Src IP	The source IP address used for management access filter match criteria.
Src interface	The interface name for the next hop to which the packet should be forwarded if it hits this filter entry.
Dest port	The destination port.
Matches	The number of times a management packet has matched this filter entry.
Protocol	The IP protocol to match.

Table 19: Show Management Access Filter Output Fields (Continued)

Label	Description
Action	The action to take for packets that match this filter entry.

```
*A:Dut-F# show system security management-access-filter ip-filter
=====
IPv4 Management Access Filter
=====
filter type:      : ip
Def. Action      : permit
Admin Status     : enabled (no shutdown)
-----
Entry            : 1
Src IP           : 192.168.0.0/16
Src interface    : undefined
Dest port        : undefined
Protocol         : undefined
Router           : undefined
Action           : none
Log              : disabled
Matches         : 0
=====
*A:Dut-F#
```

ipv6-filter

- Syntax** `ipv6-filter [entry entry-id]`
- Context** `show>system>security>mgmt-access-filter`
- Description** This command displays management-access IPv6 filters.
- Parameters** *entry-id* — Specifies the IPv6 filter entry ID to display.
- Values** 1 — 9999

Output

```
*A:Dut-C# show system security management-access-filter ipv6-filter entry 1
=====
IPv6 Management Access Filter
=====
filter type      : ipv6
Def. Action      : permit
Admin Status     : enabled (no shutdown)
-----
Entry           : 1
Src IP          : 2001::1/128
Flow label      : undefined
Src interface    : undefined
Dest port       : undefined
Next-header     : undefined
Router          : undefined
Action          : permit
Log             : enabled
```

```
Matches          : 0
=====
*A:Dut-C# s
```

password-options

- Syntax** `password-options`
- Context** `show>system>security`
- Description** This command displays configured password options.
- Output** **Password Options Output** — The following table describes password options output fields.

Table 20: Show Management Access Filter Output Fields

Label	Description
Password aging in days	Displays the number of days a user password is valid before the user must change their password.
Number of invalid attempts permitted per login	Displays the number of unsuccessful login attempts allowed for the specified time .
Time in minutes per login attempt	Displays the period of time, in minutes, that a specified number of unsuccessful attempts can be made before the user is locked out.
Lockout period (when threshold breached)	Displays the lockout period in minutes where the user is not allowed to login.
Authentication order	Displays the sequence in which password authentication is attempted among RADIUS, TACACS+, and local passwords.
Configured complexity options	Displays the complexity requirements of locally administered passwords, HMAC-MD5-96, HMAC-SHA-96 and DES-keys configured in the authentication section.
Minimum password length	Displays the minimum number of characters required for locally administered passwords, HMAC-MD5-96, HMAC-SHA-96, and DES-keys configured in the system security section.

Sample Output

```
A:ALA-7# show system security password-options
=====
Password Options
=====
Password aging in days          : none
Number of invalid attempts permitted per login : 3
Time in minutes per login attempt : 5
Lockout period (when threshold breached) : 10
Authentication order           : radius tacplus local
```

```
Configured complexity options      :
Minimum password length           : 6
=====
A:ALA-7#
```

per-peer-queuing

- Syntax** **per-peer-queuing**
- Context** show>system>security
- Description** This command enables or disables CPMCFM hardware queuing per peer. TTL security only operates when per-peer-queuing is enabled.
- Output** **Per-Peer-Queuing Output** — The following table describes per-peer-queuing output fields.

Table 21: Show Per-Peer-Queuing Output Fields

Label	Description
Per Peer Queuing	Displays the status (enabled or disabled) of CPM hardware queuing per peer.
Total Num of Queues	Displays the total number of hardware queues.
Num of Queues In Use	Displays the total number of hardware queues in use.

Sample Output

```
A:ALA-48# show system security per-peer-queuing
=====
CPM Hardware Queuing
=====
Per Peer Queuing      : Enabled
Total Num of Queues   : 8192
Num of Queues In Use  : 2
=====
A:ALA-48# configure
```

profile

- Syntax** **profile** [*user-profile-name*]
- Context** show>system>security
- Description** This command displays user profile information.
If the *profile-name* is not specified, then information for all profiles are displayed.

Parameters *user-profile-name* — Displays information for the specified user profile.

Output **User Profile Output** — The following table describes user profile output fields.

Table 22: Show User Profile Output Fields

Label	Description
User Profile	Displays the profile name used to deny or permit user console access to a hierarchical branch or to specific commands.
Def. action	Permit all — Permits access to all commands. Deny — Denies access to all commands. None — No action is taken.
Entry	The entry ID in a policy or filter table.
Description	Displays the text string describing the entry.
Match Command	Displays the command or subtree commands in subordinate command levels.
Action	Permit all — Commands matching the entry command match criteria are permitted. Deny — Commands not matching the entry command match criteria are not permitted.
No. of profiles	The total number of profiles listed.

Sample Output

```
A:ALA-7# show system security profile administrative
=====
User Profile
=====
User Profile : administrative
Def. Action  : permit-all
-----
Entry       : 10
Description :
Match Command: configure system security
Action      : permit
-----
Entry       : 20
Description :
Match Command: show system security
Action      : permit
-----
No. of profiles:
=====
A:ALA-7#
```

source-address

- Syntax** **source-address**
- Context** show>system>security
- Description** This command displays source-address configured for applications.
- Output** **Source Address Output** — The following table describes source address output fields.

Table 23: Show Source Address Output Fields

Label	Description
Application	Displays the source-address application.
IP address Interface Name	Displays the source address IP address or interface name.
Oper status	Up — The source address is operationally up. Down — The source address is operationally down.

Sample Output

```
A:SR-7# show system security source-address
=====
Source-Address applications
=====
Application          IP address/Interface Name          Oper status
-----
telnet               10.20.1.7                          Up
radius               loopback1                            Up
=====
A:SR-7#
```

ssh

- Syntax** **ssh**
- Context** show>system>security
- Description** This command displays all the SSH sessions as well as the SSH status and fingerprint.
- Output** **SSH Options Output** — The following table describes SSH output fields .

Label	Description
SSH status	SSH is enabled — Displays that SSH server is enabled. SSH is disabled — Displays that SSH server is disabled.

Label	Description (Continued)
SSH Preserve Key	Enabled — Displays that preserve-key is enabled. Disabled — Displays that preserve-key is disabled.
SSH protocol version 1	Enabled — Displays that SSH1 is enabled. Disabled — Displays that SSH1 is disabled.
SSH protocol version 2	Enabled — Displays that SSH2 is enabled. Disabled — Displays that SSH2 is disabled.
Key fingerprint	The key fingerprint is the server's identity. Clients trying to connect to the server verify the server's fingerprint. If the server fingerprint is not known, the client may not continue with the SSH session since the server might be spoofed.
Connection	The IP address of the connected router(s) (remote client).
Encryption	des — Data encryption using a private (secret) key. 3des — An encryption method that allows proprietary information to be transmitted over untrusted networks.
Username	The name of the user.
Number of SSH sessions	The total number of SSH sessions.

Sample output

```
ALA-7# show system security ssh
SSH is enabled
SSH preserve key: Enabled
SSH protocol version 1: Enabled
RSA host key finger print:c6:a9:57:cb:ee:ec:df:33:1a:cd:d2:ef:3f:b5:46:34

SSH protocol version 2: Enabled
DSA host key finger print:ab:ed:43:6a:75:90:d3:fc:42:59:17:8a:80:10:41:79
=====
Connection      Encryption      Username
=====
192.168.5.218    3des           admin
-----
Number of SSH sessions : 1
=====
ALA-7#
```

```
A:ALA-49>config>system>security# show system security ssh
SSH is disabled
A:ALA-49>config>system>security#
```

user

Syntax `user [user-id] [detail]`
`user [user-id] lockout`

Context show>system>security

Description This command displays user registration information.
 If no command line options are specified, summary information for all users displays.

Parameters *user-id* — Displays information for the specified user.

Default All users

detail — Displays detailed user information to the summary output.

lockout — Displays information about any users who are currently locked out.

Output **User Output** — The following table describes user output fields.

Label	Description
User ID	The name of a system user.
Need new pwd	Y — The user must change his password at the next login. N — The user is not forced to change his password at the next login.
Cannot change pw	Y — The user has the ability to change the login password. N — The user does not have the ability to change the login password.
User permissions	Console — Y - The user is authorized for console access. N- The user is not authorized for console access. FTP — Y - The user is authorized for FTP access. N - The user is not authorized for FTP access. SNMP — Y - The user is authorized for SNMP access. N - The user is not authorized for SNMP access.
Password expires	The number of days in which the user must change his login password.
Attempted logins	The number of times the user has attempted to login irrespective of whether the login succeeded or failed.
Failed logins	The number of unsuccessful login attempts.
Local conf	Y — Password authentication is based on the local password database. N — Password authentication is not based on the local password database.

Label	Description (Continued)
Home directory	Specifies the local home directory for the user for both console and FTP access.
Restricted to home	<p>Yes – The user is not allowed to navigate to a directory higher in the directory tree on the home directory device.</p> <p>No – The user is allowed to navigate to a directory higher in the directory tree on the home directory device.</p>
Login exec file	<p>Displays the user's login exec file which executes whenever the user successfully logs in to a console session.</p> <p>profile - the security profile(s) associated with the user</p> <p>locked-out - no / yes (time remaining). Indicates the the user is currently locked-out. After the time expires, or the lockout is manually cleared, the user will be able to attempt to log into the node again.</p> <p>Remaining Login attempts - number of login attempts remaining until the user will be locked-out</p> <p>Remaining Lockout Time - The time until the lockout is automatically cleared and the user can attempt to log into the node again.</p>

Sample Output

```
*A:Dut-C# show system security user detail
=====
Users
=====
User ID          New  User Permissions      Password      Login      Failed      Local
                  Pwd  console ftp li snmp   Expires      Attempts    Logins      Conf
-----
admin            n   y      n   n   n       never        4           0           y
-----
Number of users : 1
=====

*A:Dut-C# show system security user detail
=====
User Configuration Detail
=====
user id          : admin
-----
console parameters
-----
new pw required  : no                cannot change pw : no
home directory   :
restricted to home : no
login exec file  :
```

```

profile           : administrative
locked-out       : yes (9:23 remaining)
-----
snmp parameters
=====

*A:Node234# show system security user lockout
=====
Currently Failed Login Attempts
=====
User ID Remaining Login attempts Remaining Lockout Time (min:sec)
-----
jason123 N/A 9:56
-----
Number of users : 1
=====

```

view

- Syntax** **view** [*view-name*] [**detail**]
- Context** show>system>security
- Description** This command displays the SNMP MIB views.
- Parameters** *view-name* — Specify the name of the view to display output. If no view name is specified, the complete list of views displays.
detail — Displays detailed view information.
- Output** **View Output** — The following table describes show view output fields.

Table 24: Show View Output Fields

Label	Description
view name	The name of the view. Views control the accessibility of a MIB object within the configured MIB view and subtree.
oid tree	The object identifier of the ASN.1 subtree.
mask	The bit mask that defines a family of view subtrees.
permission	Indicates whether each view is included or excluded
No. of Views	Displays the total number of views.

Sample Output

```

A:ALA-48# show system security view
=====

```

```

Views
=====
view name          oid tree          mask          permission
-----
iso                1                included
read1             1.1.1.1          11111111     included
write1            2.2.2.2          11111111     included
testview          1                11111111     included
testview          1.3.6.1.2        11111111     excluded
mgmt-view         1.3.6.1.2.1.2    included
mgmt-view         1.3.6.1.2.1.4    included
mgmt-view         1.3.6.1.2.1.5    included
mgmt-view         1.3.6.1.2.1.6    included
mgmt-view         1.3.6.1.2.1.7    included
mgmt-view         1.3.6.1.2.1.31   included
mgmt-view         1.3.6.1.2.1.77   included
mgmt-view         1.3.6.1.4.1.6527.3.1.2.3.7 included
mgmt-view         1.3.6.1.4.1.6527.3.1.2.3.11 included
vprn-view         1.3.6.1.2.1.2    included
vprn-view         1.3.6.1.2.1.4    included
vprn-view         1.3.6.1.2.1.5    included
vprn-view         1.3.6.1.2.1.6    included
vprn-view         1.3.6.1.2.1.7    included
vprn-view         1.3.6.1.2.1.15   included
vprn-view         1.3.6.1.2.1.23   included
vprn-view         1.3.6.1.2.1.31   included
vprn-view         1.3.6.1.2.1.68   included
vprn-view         1.3.6.1.2.1.77   included
vprn-view         1.3.6.1.4.1.6527.3.1.2.3.7 included
vprn-view         1.3.6.1.4.1.6527.3.1.2.3.11 included
vprn-view         1.3.6.1.4.1.6527.3.1.2.20.1 included
no-security       1                included
no-security       1.3.6.1.6.3       excluded
no-security       1.3.6.1.6.3.10.2.1 included
no-security       1.3.6.1.6.3.11.2.1 included
no-security       1.3.6.1.6.3.15.1.1 included
on-security       2                00000000     included
-----
No. of Views: 33
=====
A:ALA-48#

```

certificate

Syntax	certificate
Context	show
Description	This command displays certificate information.

ca-profile

Syntax	ca-profile ca-profile <i>name</i> [association]
Context	show>certificate
Description	This command shows certificate-authority profile information.
Parameters	<i>name</i> — Specifies the name of the Certificate Authority (CA) profile. association — Displays associated CA profiles.

ocsp-cache

Syntax	ocsp-cache [<i>entry-id</i>]
Context	show>certificate
Description	This command displays the current cached OCSP results. The output includes the following information: <ul style="list-style-type: none">• Certificate issuer• Certificate serial number• OCSP result• Cache entry expire time
Parameters	<i>entry-id</i> — Specifies the local cache entry identifier of the certificate that was validated by the OCSP responder.

statistics

Syntax	statistics
Context	show>certificate
Description	This command shows certificate related statistics.

Login Control

users

- Syntax** **users**
- Context** show
- Description** Displays console user login and connection information.
- Output** **Users Output** — The following table describes show users output fields.

Table 25: Show Users Output Fields

Label	Description
User	The user name.
Type	The user is authorized this access type.
From	The originating IP address.
Login time	The time the user logged in.
Idle time	The amount of idle time for a specific login.
Number of users	Displays the total number of users logged in.

Sample Console Users Output

```
A:ALA-7# show users
=====
User           Type    From           Login time      Idle time
=====
testuser       Console  --             21FEB2007 04:58:55  0d 00:00:00  A
-----
Number of users : 1
'A' indicates user is in admin mode
=====
A:ALA-7#
```

Clear Commands

statistics

Syntax	statistics [interface <i>ip-int-name</i> <i>ip-address</i>]
Context	clear>router>authentication
Description	This command clears authentication statistics.
Parameters	<i>ip-int-name</i> — Clears the authentication statistics for the specified interface name. If the string contains special characters (#, \$, spaces, etc.), the entire string must be enclosed within double quotes <i>ip-address</i> — Clears the authentication statistics for the specified IP address.

ip-filter

Syntax	ip-filter [entry <i>entry-id</i>]
Context	clear>cpm-filter
Description	This command clears IP filter statistics.
Parameters	entry <i>entry-id</i> — Specifies a particular CPM IP filter entry. Values 1 — 2048

mac-filter

Syntax	mac-filter [entry <i>entry-id</i>]
Context	clear>cpm-filter
Description	This command clears MAC filter statistics.
Parameters	entry <i>entry-id</i> — Specifies a particular CPM MAC filter entry. Values 1 — 2048

ipv6-filter

Syntax	ipv6-filter [entry <i>entry-id</i>]
Context	clear>cpm-filter
Description	This command clears IPv6 filter information.
Parameters	entry <i>entry-id</i> — Specifies a particular CPM IPv6 filter entry.
Values	1 — 2048

CPU Protection Commands

cpu-protection

Syntax	cpu-protection
Context	clear
Description	This command enables the context to clear CPU protection data.

excessive-sources

Syntax	excessive-sources
Context	clear>cpu-protection
Description	This command clears the records of sources exceeding their per-source rate limit.

protocol-protection

Syntax	protocol-protection
Context	clear>cpu-protection
Description	This command clears the interface counts of packets dropped by protocol protection.

violators

Syntax	violators [port][interface][sap]
Context	clear>cpu-protection
Description	This command clears the rate limit violator record.
Parameters	port — Clears entries for ports. interface — Clears entries for interfaces. sap — Clears entries for SAPs.

cpm-queue

Syntax	cpm-queue <i>queue-id</i>
Context	clear
Description	This command clears CPM queue information.
Parameters	<i>queue-id</i> — Specifies the CPM queue ID.
Values	33 — 2000

radius-proxy-server

Syntax	radius-proxy-server <i>server-name</i> statistics
Context	clear>router
Description	This command clears RADIUS proxy server data.
Parameters	<i>server-name</i> — Specifies the proxy server name. statistics — Clears statistics for the specified server.

Debug Commands

radius

Syntax	radius [detail] [hex] no radius
Context	debug
Description	This command enables debugging for RADIUS connections. The no form of the command disables the debugging.
Parameters	detail — Displays detailed output. hex — Displays the packet dump in hex format.

OCSP

Syntax	[no] ocs
Context	debug
Description	This command enables debug output of OCSP protocol for the CA profile. The no form of the command disables the debug output.

ca-profile

Syntax	[no] ca-profile <i>profile-name</i>
Context	debug>ocs
Description	This command enables debug output of a specific CA profile.

Tools Commands

dist-cpu-protection

Syntax	dist-cpu-protection
Context	tools>perform>security tools>dump>security
Description	This command displays to release Distributed CPU Protection parameters and status at the per card and forwarding plane level.

release-hold-down

Syntax	release-hold-down interface <i>interface-name</i> [protocol <i>protocol</i>] [static-policer <i>name</i>] release-hold-down sap <i>sap-id</i> [protocol <i>protocol</i>] [static-policer <i>name</i>]
Context	tools>perform>security>dist-cput protection
Description	This command is used to release a Distributed CPU Protection (DCP) policer from a hold-down countdown (or indefinite hold-down if configured as such).
Parameters	interface <i>interface-name</i> — Specifies Router interface name. sap <i>sap-id</i> — Specify sap identifier. protocol <i>protocol</i> — Specifies DCP protocol name (for example, arp, dhcp) static-policer <i>name</i> — Specifies DCP static policer name as defined in the DCP policy.

violators

Syntax	violators enforcement { sap interface } card <i>slot-number</i> [fp <i>fp-number</i>] violators local-monitor { sap interface } card <i>slot-number</i> [fp <i>fp-number</i>]
Context	tools>dump>security>dist-cput protection
Description	This command shows the non-conformant enforcement policers and local monitors.
Parameters	sap — -Indicates to display the violators associated with SAPs interface — - Indicates to display the violators associated with router interfaces. enforcement — Shows exceed and hold-down for Static and Dynamic Policers. local-monitor — Shows state of dynamic policer allocation for Local Monitoring Policers.

card *slot-number* — The physical slot number for the card.

Values 1— n (n is platform dependant)

fp *fp-number* — Identifies the instance of the FP (FastPath) chipset. Some cards have a single FP (for example, an IOM3-XP) and some cards can contain multiple FPs (for example, an IOM2 has two FPs and an XCM can house two FPs via its two XMASs).

Values 1— 2

Output Users Output — The following table describes show users output fields.

Table 26: Output Parameters

Label	Description
Interface	The name of the router interface
Policer/Protocol	The configured name of the static policer (indicated with an [S]) or the DCP protocol name for a dynamic policer (indicated with a [D]).
[S] / [D]	indicates a static vs dynamic policer
Hld Rem	The remaining time in the hold-down countdown during which a policer is treating all packets as exceeding.

Sample Output

```
*A:Dut-A# tools dump security dist-cpu-protection violators enforcement interface
card 4 fp 1
=====
Distributed Cpu Protection Current Interface Enforcer Policer Violators
=====
Interface                Policer/Protocol                Hld Rem
-----
Violators on Slot-4 Fp-1
-----
test                      staticArpPolicer                [S] none
test                      icmp                            [D] none
test                      ospf                            [D] none
-----
[S]-Static [D]-Dynamic [M]-Monitor
=====
```

Admin Commands

clear lockout

- Syntax** `clear lockout {user name | all}`
- Context** admin>user
- Description** This command is used to clear any lockouts for a specific user, or for all users.
- Parameters** *name* — Specifies locked username.

clear password-history

- Syntax** `clear password-history {user name | all}`
- Context** admin>user
- Description** This command is used to clear old passwords used by a specific user, or for all users.
- Parameters** *name* — Specifies username.

In This Chapter

This chapter provides information to configure SNMP.

Topics in this chapter include:

- [SNMP Overview on page 280](#)
 - [SNMP Architecture on page 280](#)
 - [Management Information Base on page 280](#)
 - [SNMP Protocol Operations on page 281](#)
 - [SNMP Versions on page 281](#)
 - [Management Information Access Control on page 282](#)
 - [User-Based Security Model Community Strings on page 283](#)
 - [Views on page 283](#)
 - [Access Groups on page 283](#)
 - [Users on page 284](#)
- [Which SNMP Version to Use? on page 285](#)
- [Configuration Notes on page 287](#)

SNMP Overview

SNMP Architecture

The Service Assurance Manager (SAM) is comprised of two elements: managers and agents. The manager is the entity through which network management tasks are facilitated. Agents interface managed objects. Managed devices, such as bridges, hubs, routers, and network servers can contain managed objects. A managed object can be a configuration attribute, performance statistic, or control action that is directly related to the operation of a device.

Managed devices collect and store management information and use Simple Network Management Protocol (SNMP). SNMP is an application-layer protocol that provides a message format to facilitate communication between SNMP managers and agents. SNMP provides a standard framework to monitor and manage devices in a network from a central location.

An SNMP manager controls and monitors the activities of network hosts which use SNMP. An SNMP manager can obtain (get) a value from an SNMP agent or store (set) a value in the agent. The manager uses definitions in the management information base (MIB) to perform operations on the managed device such as retrieving values from variables or blocks of data, replying to requests, and processing traps.

Between the SNMP agent and the SNMP manager the following actions can occur:

- The manager can get information from the agent.
- The manager can set the value of a MIB object that is controlled by an agent.
- The agent can send traps to notify the manager of significant events that occur on the router.

Management Information Base

A MIB is a formal specifications document with definitions of management information used to remotely monitor, configure, and control a managed device or network system. The agent's management information consists of a set of network objects that can be managed with SNMP. Object identifiers are unique object names that are organized in a hierarchical tree structure. The main branches are defined by the Internet Engineering Task Force (IETF). When requested, the Internet Assigned Numbers Authority (IANA) assigns a unique branch for use by a private organization or company. The branch assigned to Alcatel-Lucent (TiMetra) is 1.3.6.1.4.1.6527.

The SNMP agent provides management information to support a collection of IETF specified MIBs and a number of MIBs defined to manage device parameters and network data unique to Alcatel-Lucent's router.

SNMP Protocol Operations

Between the SNMP agent and the SNMP manager the following actions can occur:

- The manager can get information from the agent.
 - The manager can set the value of a MIB object that is controlled by an agent.
 - The agent notifies the manager of significant events that occur on the router.
-

SNMP Versions

The agent supports multiple versions of the SNMP protocol.

- SNMP Version 1 (SNMPv1) is the original Internet-standard network management framework.
SNMPv1 uses a community string match for authentication.
- The OS implementation uses SNMPv2c, the community-based administrative framework for SNMPv2. SNMPv2c uses a community string match for authentication.
- In SNMP Version 3 (SNMPv3), USM defines the user authentication and encryption features. View Access Control MIB (VACM) defines the user access control features. The SNMP-COMMUNITY-MIB is used to associate SNMPv1/SNMPv2c community strings with SNMPv3 VACM access control.
SNMPv3 uses a username match for authentication.

Management Information Access Control

By default, the OS implementation of SNMP uses SNMPv3. SNMPv3 incorporates security model and security level features. A security model is the authentication type for the group and the security level is the permitted level of security within a security model. The combination of the security level and security model determines which security mechanism handles an SNMP packet.

To implement SNMPv1 and SNMPv2c configurations, several access groups are predefined. These access groups provide standard read-only, read-write, and read-write-all access groups and views that can simply be assigned community strings. In order to implement SNMP with security features, security models, security levels, and USM communities must be explicitly configured. Optionally, additional views which specify more specific OIDs (MIB objects in the subtree) can be configured.

Access to the management information in as SNMPv1/SNMPv2c agent is controlled by the inclusion of a community name string in the SNMP request. The community defines the subset of the agent's managed objects can be accessed by the requester. It also defines what type of access is allowed: read-only or read-write.

The use of community strings provide minimal security and context checking for both agents and managers that receive requests and initiate trap operations. A community string is a text string that acts like a password to permit access to the agent on the router.

Alcatel-Lucent's implementation of SNMP has defined three levels of community-named access:

- Read-Only permission — Grants only read access to objects in the MIB, except security objects.
- Read-Write permission — Grants read and write access to all objects in the MIB, except security objects.
- Read-Write-All permission — Grants read and write access to all objects in the MIB, including security objects.

User-Based Security Model Community Strings

User-based security model (USM) community strings associates a community string with an SNMPv3 access group and its view. The access granted with a community string is restricted to the scope of the configured group.

Views

Views control the access to a managed object. The total MIB of a router can be viewed as a hierarchical tree. When a view is created, either the entire tree or a portion of the tree can be specified and made available to a user to manage the objects contained in the subtree. Object identifiers (OIDs) uniquely identify managed objects. A view defines the type of operations for the view such as read, write, or notify.

OIDs are organized in a hierarchical tree with specific values assigned to different organizations. A view defines a subset of the agent's managed objects controlled by the access rules associated with that view.

Pre-defined views are available that are particularly useful when configuring SNMPv1 and SNMPv2c.

The Alcatel-Lucent SNMP agent associates SNMPv1 and SNMPv2c community strings with a SNMPv3 view.

Access Groups

Access groups associate a user group and a security model to the views the group can access. An access group is defined by a unique combination of a group name, security model (SNMPv1, SNMPv2c, or SNMPv3), and security level (no-authorization-no-privacy, authorization-no-privacy, or privacy).

An access group, in essence, is a template which defines a combination of access privileges and views. A group can be associated to one or more network users to control their access privileges and views.

Additional access parameters must be explicitly configured if the preconfigured access groups and views for SNMPv1 and SNMPv2c do not meet your security requirements.

Users

By default, authentication and encryption parameters are not configured. Authentication parameters which a user must use in order to be validated by the router can be modified. SNMP authentication allows the device to validate the managing node that issued the SNMP message and determine if the message has been tampered with.

User access and authentication privileges must be explicitly configured. In a user configuration, a user is associated with an access group, which is a collection of users who have common access privileges and views (see [Access Groups](#)).

Which SNMP Version to Use?

SNMPv1 and SNMPv2c do not provide security, authentication, or encryption. Without authentication, a non authorized user could perform SNMP network management functions and eavesdrop on management information as it passes from system to system. Many SNMPv1 and SNMPv2c implementations are restricted read-only access, which, in turn, reduces the effectiveness of a network monitor in which network control applications cannot be supported.

To implement SNMPv3, an authentication and encryption method must be assigned to a user in order to be validated by the router. SNMP authentication allows the router to validate the managing node that issued the SNMP message and determine if the message was tampered with.

[Figure 7](#) depicts the configuration requirements to implement SNMPv1/SNMPv2c, and SNMPv3.

Which SNMP Version to Use?

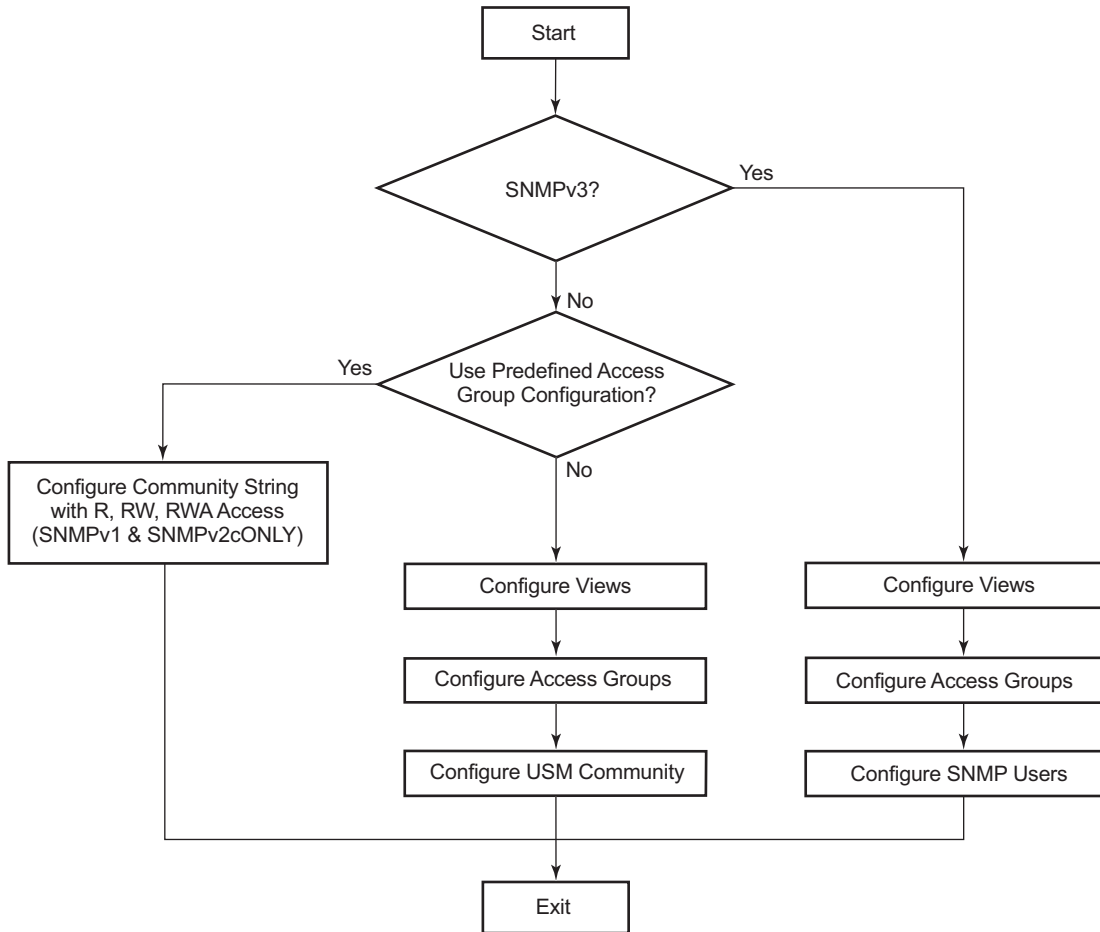

al_0203

Figure 7: SNMPv1 and SNMPv2c Configuration and Implementation Flow

Configuration Notes

This section describes SNMP configuration caveats.

General

- To avoid management systems attempting to manage a partially booted system, SNMP will remain in a shut down state if the configuration file fails to complete during system startup. While shutdown, SNMP gets and sets are not processed. However, notifications are issued if an SNMP trap group has been configured.

In order to enable SNMP, the portions of the configuration that failed to load must be initialized properly. Start SNMP with the **config>system>snmp>no shutdown** CLI command.

- Use caution when changing the SNMP engine ID. If the SNMP engine ID is changed in the **config>system>snmp> engineID** *engine-id* context, the current configuration must be saved and a reboot must be executed. If not, the previously configured SNMP communities and logger trap-target notify communities will not be valid for the new engine ID.

Configuring SNMP with CLI

This section provides information about configuring SNMP with CLI.

Topics in this chapter include:

- [SNMP Configuration Overview on page 290](#)
- [Basic SNMP Security Configuration on page 291](#)
- [Configuring SNMP Components on page 292](#)

SNMP Configuration Overview

This section describes how to configure SNMP components which apply to SNMPv1 and SNMPv2c, and SNMPv3 on the router.

- [Configuring SNMPv1 and SNMPv2c on page 290](#)
 - [Configuring SNMPv3 on page 290](#)
-

Configuring SNMPv1 and SNMPv2c

Alcatel-Lucent routers are based on SNMPv3. To use the routers with SNMPv1 and/or SNMPv2c, SNMP community strings must be configured. Three pre-defined access methods are available when SNMPv1 or SNMPv2c access is required. Each access method (**r**, **rw**, or **rwa**) is associated with an SNMPv3 access group that determines the access privileges and the scope of managed objects available. The **community** command is used to associate a community string with a specific access method and the required SNMP version (SNMPv1 or SNMPv2c). The access methods are:

- Read-Only — Grants read only access to the entire management structure with the exception of the security area.
- Read-Write — Grants read and write access to the entire management structure with the exception of the security area.
- Read-Write-All — Grants read and write access to the entire management structure, including security.

If the predefined access groups do not meet your access requirements, then additional access groups and views can be configured. The **usm-community** command is used to associate an access group with an SNMPv1 or SNMPv2c community string.

SNMP trap destinations are configured in the **config>log>snmp-trap-group** context.

Configuring SNMPv3

The OS implements SNMPv3. If security features other than the default views are required, then the following parameters must be configured:

- Configure views
- Configure access groups
- Configure SNMP users

Basic SNMP Security Configuration

This section provides information to configure SNMP parameters and provides examples of common configuration tasks. The minimal SNMP parameters are:

For SNMPv1 and SNMPv2c:

- Configure community string parameters.

For SNMPv3:

- Configure view parameters
- Configure SNMP group
- Configure access parameters
- Configure user with SNMP parameters

The following displays SNMP default views, access groups, and attempts parameters.

```
A:ALA-1>config>system>security>snmp# info detail
-----
      view iso subtree 1
            mask ff type included
      exit
      view no-security subtree 1
            mask ff type included
      exit
      view no-security subtree 1.3.6.1.6.3
            mask ff type excluded
      exit
      view no-security subtree 1.3.6.1.6.3.10.2.1
            mask ff type included
      exit
      view no-security subtree 1.3.6.1.6.3.11.2.1
            mask ff type included
      exit
      view no-security subtree 1.3.6.1.6.3.15.1.1
            mask ff type included
      exit
      access group snmp-ro security-model snmpv1 security-level no-auth-no-
privacy read no-security notify no-security
      access group snmp-ro security-model snmpv2c security-level no-auth-no-
privacy read no-security notify no-security
      access group snmp-rw security-model snmpv1 security-level no-auth-no-
privacy read no-security write no-security notify no-security
      access group snmp-rw security-model snmpv2c security-level no-auth-no-
privacy read no-security write no-security notify no-security
      access group snmp-rwa security-model snmpv1 security-level no-auth-no-
privacy read iso write iso notify iso
      access group snmp-rwa security-model snmpv2c security-level no-auth-no-
privacy read iso write iso notify iso
      access group snmp-trap security-model snmpv1 security-level no-auth-no-
privacy notify iso
      access group snmp-trap security-model snmpv2c security-level no-auth-
no-privacy notify iso
      attempts 20 time 5 logout 10
```

Configuring SNMP Components

Use the CLI syntax displayed below to configure the following SNMP scenarios:

- [Configuring a Community String on page 293](#)
- [Configuring View Options on page 294](#)
- [Configuring Access Options on page 295](#)
- [Configuring USM Community Options on page 297](#)
- [Configuring Other SNMP Parameters on page 298](#)

CLI Syntax: `config>system>security>snmp`
 `attempts [count] [time minutes1] [lockout minutes2]`
 `community community-string access-permissions [version SNMP`
 `version]`
 `usm-community community-string group group-name`
 `view view-name subtree oid-value`
 `mask mask-value [type {included|excluded}]`
 `access group group-name security-model security-model secu-`
 `rity-level security-level [context context-name [pre-`
 `fix-match]] [read view-name-1] [write view-name-2]`
 `[notify view-name-3]`

Configuring a Community String

SNMPv1 and SNMPv2c community strings are used to define the relationship between an SNMP manager and agent. The community string acts like a password to permit access to the agent. The access granted with a community string is restricted to the scope of the configured group.

One or more of these characteristics associated with the string can be specified:

- Read-only, read-write, and read-write-all permission for the MIB objects accessible to the community.
- The SNMP version, SNMPv1 or SNMPv2c.

Default access features are pre-configured by the agent for SNMPv1/SNMPv2c.

Use the following CLI syntax to configure community options:

CLI Syntax: `config>system>security>snmp
community community-string access-permissions [version SNMP
version]`

The following displays an SNMP community configuration example:

```
*A:cses-A13>config>system>security>snmp# info
-----
community "uTdc9j48PBRkxn5DcSjchk" hash2 rwa version both
community "Lla.RtAyRW2" hash2 r version v2c
community "r0a159kIOfg" hash2 r version both
-----
*A:cses-A13>config>system>security>snmp#
```

Configuring View Options

Use the following CLI syntax to configure view options:

CLI Syntax: `config>system>security>snmp`
`view view-name subtree oid-value`
`mask mask-value [type {included|excluded}]`

The following displays a view configuration example:

```
*A:cses-A13>config>system>security>snmp# info
-----
      view "testview" subtree "1"
      mask ff
      exit
      view "testview" subtree "1.3.6.1.2"
      mask ff type excluded
      exit
      community "uTdc9j48PBRkxn5DcSjchk" hash2 rwa version both
      community "Lla.RtAyRW2" hash2 r version v2c
      community "r0a159kIOfg" hash2 r version both
-----
*A:cses-A13>config>system>security>snmp#
```

Configuring Access Options

The **access** command creates an association between a user group, a security model and the views that the user group can access. Access must be configured unless security is limited to the preconfigured access groups and views for SNMPv1 and SNMPv2. An access group is defined by a unique combination of the group name, security model and security level.

Use the following CLI syntax to configure access features:

CLI Syntax: `config>system>security>snmp`
`access group group-name security-model security-model security-level security-level [context context-name [prefix-match]] [read view-name-1] [write view-name-2] [notify view-name-3]`

The following displays an access configuration with the view configurations.

```
*A:cses-A13>config>system>security>snmp# info
-----
view "testview" subtree "1"
  mask ff
  exit
view "testview" subtree "1.3.6.1.2"
  mask ff type excluded
  exit
access group "test" security-model usm security-level auth-no-privacy read "testview" write "testview" notify "testview"
community "uTdc9j48PBRkxn5DcSjchk" hash2 rwa version both
community "Lla.RtAyRW2" hash2 r version v2c
community "r0a159kIOfg" hash2 r version both
-----
*A:cses-A13>config>system>security>snmp#
```

Configuring SNMP Components

Use the following CLI syntax to configure user group and authentication parameters:

CLI Syntax: config>system>security# user user-name
access [ftp] [snmp] [console]
snmp
authentication [none] | [[hash] {md5 key|sha key } privacy
{none|des-key|aes-128-cfb-key key}]
group group-name

The following displays a user's SNMP configuration example.

```
A:ALA-1>config>system>security# info
-----
user "testuser"
  access snmp
  snmp
  authentication hash md5 e14672e71d3e96e7a1e19472527ee969 privacy none
  group testgroup
  exit
exit
...
-----
A:ALA-1>config>system>security#
```

Configuring USM Community Options

User-based security model (USM) community strings associate a community string with an SNMPv3 access group and its view. The access granted with a community string is restricted to the scope of the configured group.

By default, the OS implementation of SNMP uses SNMPv3. However, to implement SNMPv1 and SNMPv2c, USM community strings must be explicitly configured.

Use the following CLI syntax to configure USM community options:

CLI Syntax: `config>system>security>snmp`
`usm-community community-string group group-name`

The following displays a SNMP community configuration example:

```
A:ALA-1>config>system>security>snmp# info
-----
view "testview" subtree "1"
    mask ff
    exit
    view "testview" subtree "1.3.6.1.2"
        mask ff type excluded
    exit
access group "test" security-model usm security-level auth-no-pr
ivacy read "testview" write "testview" notify "testview"
community "uTdc9j48PBRkxn5DcSjchk" hash2 rwa version both
community "Lla.RtAyRW2" hash2 r version v2c
community "r0a159kIOfg" hash2 r version both
-----
A:ALA-1>config>system>security>snmp#
```

The group **grouptest** was configured in the `config>system>security>snmp>access` CLI context.

Configuring Other SNMP Parameters

Use the following CLI syntax to modify the system SNMP options:

CLI Syntax: `config>system>snmp`
`engineID engine-id`
`general-port port`
`packet-size bytes`
`no shutdown`

The following example displays the system SNMP default values:

```
A:ALA-104>config>system>snmp# info detail
-----
      shutdown
      engineID "0000xxxx000000000xxxxx00"
      packet-size 1500
      general-port 161
-----
A:ALA-104>config>system>snmp#
```

SNMP Command Reference

Command Hierarchies

Configuration Commands

SNMP System Commands

```

config
  — system
    — snmp
      — engineID engine-id
      — no engineID
      — general-port port
      — no general-port
      — packet-size bytes
      — no packet-size
      — streaming
        — [no] shutdown
      — [no] shutdown
  
```

SNMP Security Commands

```

config
  — system
    — security
      — snmp
        — access group group-name security-model security-model security-level security-level [context context-name [prefix-match]] [read view-name-1] [write view-name-2] [notify view-name-3]
        — no access group group-name [security-model security-model] [security-level security-level] [context context-name [prefix-match]] [read view-name-1] [write view-name-2] [notify view-name-3]
        — attempts [count] [time minutes1] [lockout minutes2]
        — no attempts
        — community community-string access-permissions [version SNMP-version]
        — no community community-string
        — usm-community community-string group group-name
        — no usm-community community-string
        — view view-name subtree oid-value
        — no view view-name [subtree oid-value]
          — mask mask-value [type {included | excluded}]
          — no mask
      — service
        — vprn service-id [customer customer-id]
        — no vprn service-id
          — [no] snmp-access
          — snmp-community community-name [version SNMP-version]
          — no snmp-community community-name [hash|hash2]
  
```

SNMP Command Reference

The following commands configure user-specific SNMP features. Refer to the **Security** section for CLI syntax and command descriptions.

```
config
  — system
    — security
      — [no] user user-name
        — [no] snmp
          — authentication {[none] | [[hash] {md5 key-1 | sha key-1}
          — privacy {none|des-key|aes-128-cfb-key key-2}]
          — group group-name
          — [no] group
```

Show Commands

```
show
  — snmp
    — counters
    — streaming
      — counters
  — system
    — information
    — security
      — access-group [group-name]
      — authentication [statistics]
      — communities
      — password-options [entry-id]
      — password-options
      — per-peer-queuing
      — profile [profile-name]
      — ssh
      — user [user-id] [detail]
      — view [view-name] [detail]
```

Configuration Commands

SNMP System Commands

engineID

Syntax	[no] engineID <i>engine-id</i>
Context	config>system>snmp
Description	<p>This command sets the SNMP engineID to uniquely identify the SNMPv3 node. By default, the engineID is generated using information from the system backplane.</p> <p>If SNMP engine ID is changed in the config>system>snmp> engineID <i>engine-id</i> context, the current configuration must be saved and a reboot must be executed. If not, the previously configured SNMP communities and logger trap-target notify communities will not be valid for the new engine ID.</p> <p>Note: In conformance with IETF standard RFC 2274, <i>User-based Security Model (USM) for version 3 of the Simple Network Management Protocol (SNMPv3)</i>, hashing algorithms which generate SNMPv3 MD5 or SHA security digest keys use the engineID. Changing the SNMP engineID invalidates all SNMPv3 MD5 and SHA security digest keys and may render the node unmanageable.</p> <p>When a chassis is replaced, use the engine ID of the first system and configure it in the new system to preserve SNMPv3 security keys. This allows management stations to use their existing authentication keys for the new system.</p> <p>Ensure that the engine IDs are not used on multiple systems. A management domain can only have one instance of each engineID.</p> <p>The no form of the command reverts to the default setting.</p>
Default	The engine ID is system generated.
Parameters	<i>engine-id</i> — An identifier from 10 to 64 hexadecimal digits (5 to 32 octet number), uniquely identifying this SNMPv3 node. This string is used to access this node from a remote host with SNMPv3.

general-port

Syntax	general-port <i>port-number</i> no general-port
Context	config>system>snmp
Description	This command configures the port number used by this node to receive SNMP request messages and to send replies. Note that SNMP notifications generated by the agent are sent from the port specified in the config>log>snmp-trap-group>trap-target CLI command. The no form of the command reverts to the default value.
Default	161
Parameters	<i>port-number</i> — The port number used to send SNMP traffic other than traps. Values 1 — 65535 (decimal)

packet-size

Syntax	packet-size <i>bytes</i> no packet-size
Context	config>system>snmp
Description	This command configures the maximum SNMP packet size generated by this node. If the packet size exceeds the MTU size of the egress interface the packet will be fragmented. The no form of this command to revert to default.
Default	1500 bytes
Parameters	<i>bytes</i> — The SNMP packet size in bytes. Values 484 — 9216

snmp

Syntax	snmp
Context	config>system
Description	This command creates the context to configure SNMP parameters.

streaming

Syntax	snmp
Context	config>system>snmp>streaming
Description	This command enables the proprietary SNMP request/response bundling and TCP-based transport mechanism for optimizing network management of the router nodes. In higher latency networks, synchronizing router MIBs from network management via streaming takes less time than synchronizing via classic SNMP UDP requests. Streaming operates on TCP port 1491 and runs over IPv4 or IPv6.

shutdown

Syntax	[no] shutdown
Context	config>system>snmp>streaming
Description	This command administratively disables proprietary SNMP request/response bundling and TCP-based transport mechanism for optimizing network management of the router nodes.. The no form of the command administratively re-enables SNMP request/response bundling and TCP-based transport mechanism.
Default	shutdown

shutdown

Syntax	[no] shutdown
Context	config>system>snmp
Description	This command administratively disables SNMP agent operations. System management can then only be performed using the command line interface (CLI). Shutting down SNMP does not remove or change configuration parameters other than the administrative state. This command does not prevent the agent from sending SNMP notifications to any configured SNMP trap destinations. SNMP trap destinations are configured under the config>log>snmp-trap-group context. This command is automatically invoked in the event of a reboot when the processing of the configuration file fails to complete or when an SNMP persistent index file fails while the bof persist on command is enabled. The no form of the command administratively enables SNMP which is the default state.
Default	no shutdown

SNMP Security Commands

access group

Syntax	[no] access group <i>group-name</i> security-model <i>security-model</i> security-level <i>security-level</i> [context <i>context-name</i> [prefix-match]] [read <i>view-name-1</i>] [write <i>view-name-2</i>] [notify <i>view-name-3</i>]
Context	config>system>security>snmp
Description	<p>This command creates an association between a user group, a security model, and the views that the user group can access. Access parameters must be configured unless security is limited to the preconfigured access groups and views for SNMPv1 and SNMPv2. An access group is defined by a unique combination of the group name, security model and security level.</p> <p>Access must be configured unless security is limited to SNMPv1/SNMPv2c with community strings (see the community on page 306).</p> <p>Default access group configurations cannot be modified or deleted.</p> <p>To remove the user group with associated, security model(s), and security level(s), use: no access group <i>group-name</i></p> <p>To remove a security model and security level combination from a group, use: no access group <i>group-name</i> security-model {snmpv1 snmpv2c usm} security-level {no-auth-no-privacy auth-no-privacy privacy}</p>
Default	none
Parameters	<p><i>group-name</i> — Specify a unique group name up to 32 characters.</p> <p>security-model {snmpv1 snmpv2c usm} — Specifies the security model required to access the views configured in this node. A group can have multiple security models. For example, one view may only require SNMPv1/ SNMPv2c access while another view may require USM (SNMPv3) access rights.</p> <p>security-level {no-auth-no-priv auth-no-priv privacy} — Specifies the required authentication and privacy levels to access the views configured in this node.</p> <p>security-level no-auth-no-privacy — Specifies that no authentication and no privacy (encryption) is required. When configuring the user's authentication, select the none option.</p> <p>security-level auth-no-privacy — Specifies that authentication is required but privacy (encryption) is not required. When this option is configured, both the group and the user must be configured for authentication.</p> <p>security-level privacy — Specifies that both authentication and privacy (encryption) is required. When this option is configured, both the group and the user must be configured for authentication. The user must also be configured for privacy.</p> <p>context <i>context-name</i> — Specifies a set of SNMP objects that are associated with the context-name.</p>

The *context-name* is treated as either a full context-name string or a context name prefix depending on the keyword specified (**exact** or **prefix**).

prefix-match — Specifies the context name **prefix-match** keywords, **exact** or **prefix**.

The VPRN context names begin with a **vprn** prefix. The numerical value is associated with the service ID that the VPRN was created with and identifies the service in the service domain. For example, when a new VPRN service is created such as **config>service>vprn 2345 customer 1**, a VPRN with context name **vprn2345** is created.

The **exact** keyword specifies that an exact match between the context name and the prefix value is required. For example, when **context vprn2345 exact** is entered, matches for only **vprn2345** are considered.

The **prefix** keyword specifies that only a match between the prefix and the starting portion of context name is required. If only the **prefix** keyword is specified, simple wildcard processing is used. For example, when **context vprn prefix** is entered, all **vprn** contexts are matched.

Default **exact**

read *view-name* — Specifies the keyword and variable of the view to read the MIB objects. This command must be configured for each view to which the group has read access.

Default **none**

write *view-name* — Specifies the keyword and variable of the view to configure the contents of the agent.

This command must be configured for each view to which the group has write access.

Values Up to 32 characters

notify *view-name* — specifies keyword and variable of the view to send a trap about MIB objects. This command must be configured for each view to which the group has notify access.

Values none

attempts

Syntax	attempts [<i>count</i>] [time <i>minutes1</i>] [lockout <i>minutes2</i>] no attempts
Context	config>system>security>snmp
Description	This command configures a threshold value of unsuccessful SNMP connection attempts allowed in a specified time frame. The command parameters are used to counter denial of service (DOS) attacks through SNMP. If the threshold is exceeded, the host is locked out for the lockout time period. If multiple attempts commands are entered, each command overwrites the previously entered command. The no form of the command resets the parameters to the default values.
Default	attempts 20 time 5 lockout 10 — 20 failed SNMP attempts allowed in a 5 minute period with a 10 minute lockout for the host if exceeded.

Parameters	<p><i>count</i> — The number unsuccessful SNMP attempts allowed for the specified time.</p> <p>Default 20</p> <p>Values 1 — 64</p> <p>time <i>minutes1</i> — The period of time, in minutes, that a specified number of unsuccessful attempts can be made before the host is locked out.</p> <p>Default 5</p> <p>Values 0 — 60</p> <p>lockout <i>minutes2</i> — The lockout period in minutes where the host is not allowed to login. When the host exceeds the attempted count times in the specified time, then that host is locked out from any further login attempts for the configured time period.</p> <p>Default 10</p> <p>Values 0 — 1440</p>
-------------------	---

community

Syntax	<p>community <i>community-string</i> <i>access-permissions</i> [version <i>SNMP-version</i>]</p> <p>no community <i>community-string</i>]</p>
Context	config>system>security>snmp
Description	<p>This command creates SNMP community strings for SNMPv1 and SNMPv2c access. This command is used in combination with the predefined access groups and views. To create custom access groups and views and associate them with SNMPv1 or SNMPv2c access use the <code>usm-community</code> command.</p> <p>When configured, <code>community</code> implies a security model for SNMPv1 and SNMPv2c only. For SNMPv3 security, the access group command on page 304 must be configured.</p> <p>The no form of the command removes a community string.</p>
Default	none
Parameters	<p><i>community-string</i> — Configure the SNMPv1 / SNMPv2c community string.</p> <p><i>access-permissions</i> — r — Grants only read access to objects in the MIB, except security objects.</p> <ul style="list-style-type: none"> • rw — Grants read and write access to all objects in the MIB, except security. • rwa — Grants read and write access to all objects in the MIB, including security. • vpls-mgmt — Assigns a unique SNMP community string to the management virtual router. <p>version {v1 v2c both} — Configures the scope of the community string to be for SNMPv1, SNMPv2c, or both SNMPv1 and SNMPv2c access.</p> <p>Default both</p>

mask

Syntax	mask <i>mask-value</i> [type { included excluded }] no mask
Context	config>system>security>snmp>view <i>view-name</i>
Description	<p>The mask value and the mask type, along with the <i>oid-value</i> configured in the view command, determines the access of each sub-identifier of an object identifier (MIB subtree) in the view.</p> <p>Each bit in the mask corresponds to a sub-identifier position. For example, the most significant bit for the first sub-identifier, the next most significant bit for the second sub-identifier, and so on. If the bit position on the sub-identifier is available, it can be included or excluded.</p> <p>For example, the MIB subtree that represents MIB-II is 1.3.6.1.2.1. The mask that catches all MIB-II would be 0xfc or 0b11111100.</p> <p>Only a single mask may be configured per view and OID value combination. If more than one entry is configured, each subsequent entry overwrites the previous entry.</p> <p>Per RFC 2575, <i>View-based Access Control Model (VACM) for the Simple Network Management Protocol (SNMP)</i>, each MIB view is defined by two sets of view subtrees, the included view subtrees, and the excluded view subtrees. Every such view subtree, both the included and the excluded ones, are defined in this table. To determine if a particular object instance is in a particular MIB view, compare the object instance's object identifier (OID) with each of the MIB view's active entries in this table. If none match, then the object instance is not in the MIB view. If one or more match, then the object instance is included in, or excluded from, the MIB view according to the value of <i>vacmViewTreeFamilyType</i> in the entry whose value of <i>vacmViewTreeFamilySubtree</i> has the most sub-identifiers.</p> <p>The no form of this command removes the mask from the configuration.</p>
Default	none
Parameters	<p><i>mask-value</i> — The mask value associated with the OID value determines whether the sub-identifiers are included or excluded from the view. (Default: all 1^s)</p> <p>The mask can be entered either:</p> <ul style="list-style-type: none"> • In hex. For example, 0xfc. • In binary. For example, 0b11111100. <p>Note: If the number of bits in the bit mask is less than the number of sub-identifiers in the MIB subtree, then the mask is extended with ones until the mask length matches the number of sub-identifiers in the MIB subtree.</p> <p>type {included excluded} — Specifies whether to include or exclude MIB subtree objects. <i>included</i> - All MIB subtree objects that are identified with a 1 in the mask are available in the view. (Default: <i>included</i>).</p> <p><i>excluded</i> - All MIB subtree objects that are identified with a 1 in the mask are denied access in the view. (Default: <i>included</i>).</p> <p>Default included</p>

snmp

Syntax	snmp
Context	config>system>security
Description	This command creates the context to configure SNMPv1, SNMPv2, and SNMPv3 parameters.

snmp-access

Syntax	[no] snmp-access
Context	config>service>vprn
Description	This command enables/disables SNMP access on the VPRN interface. Refer to the 7x50 SR OS Services Guide for detailed information about VPRN CLI command syntax and descriptions.

snmp-community

Syntax	snmp-community <i>community-name</i> [hash hash2] [<i>access-permissions</i>] [version <i>SNMP-version</i>] no snmp-community <i>community-name</i> [hash hash2]
Context	config>service>vprn
Description	<p>This command sets the SNMP community name(s) to be used with the associated VPRN instance. These VPRN community names are used to associate SNMP v1/v2c requests with a particular vprn context and to return a reply that contains VPRN-specific data or limit SNMP access to data in a specific VPRN instance.</p> <p>VPRN snmp communities configured with an access permission of 'r' are automatically associated with the default access group "snmp-vprn-ro" and the "vprn-view" view (read only).</p> <p>VPRN snmp communities configured with an access permission of 'rw' are automatically associated with the default access group "snmp-vprn" and the "vprn-view" view (read/write).</p> <p>The community in an SNMP v1/v2 request determines the SNMP context (i.e. the vprn# for accessing SNMP tables) and not the VPRN of the incoming interface on which the request was received. When an SNMP request arrives on VPRN 5 interface "ringo" with a destination IP address equal to the "ringo" interface, but the community in the SNMP request is the community configured against VPRN 101, then the SNMP request will be processed using the VPRN 101 context. (the response will contain information about VPRN 101). It is recommended to avoid using a simple series of vprn snmp-community values that are similar to each other (for example, avoid my-vprn-comm-1, my-vprn-comm-2, etc).</p> <p>The no form of the command removes the SNMP community name from the given VPRN context.</p>
Default	None — The SNMP community must be explicitly specified.

- Parameters**
- community-name* — Specifies the SNMP v1/v2c community name. This is a secret/confidential key used to access SNMP and specify a context (base vs vprn1 vs vprn2).
 - hash** — Specifies the key is entered in an encrypted form. If the hash parameter is not used, the key is assumed to be in a non-encrypted, clear text form. For security, all keys are stored in encrypted form.
 - hash2** — Specifies the key is entered in a more complex encrypted form.
 - version** *SNMP-version* — Specifies the SNMP version.
 - Values** **v1, v2c, both**
 - access-permissions* — Specifies the access rights to MIB objects.
 - Values** **r** — Grants only read access to MIB objects. Creates an association of the community-name with the "snmp-vprn-ro" access group.
 - rw** — Grants read and write access to MIB objects. Creates an association of the community-name with the "snmp-vprn" access group.

usm-community

- Syntax** **usm-community** *community-string* **group** *group-name*
no usm-community *community-string*
- Context** config>system>security>snmp
- Description** This command is used to associate a community string with an SNMPv3 access group and its view. The access granted with a community string is restricted to the scope of the configured group.
- Alcatel-Lucent's SR OS implementation of SNMP uses SNMPv3. In order to implement SNMPv1 and SNMPv2c configurations, several access groups are predefined. In order to implement SNMP with security features (Version 3), security models, security levels, and USM communities must be explicitly configured. Optionally, additional views which specify more specific OIDs (MIB objects in the subtree) can be configured.
- The **no** form of this command removes a community string.
- Default** none
- Parameters**
- community-string* — Configures the SNMPv1/SNMPv2c community string to determine the SNMPv3 access permissions to be used.
 - group* — Specify the group that governs the access rights of this community string. This group must be configured first in the **config system security snmp access group** context.
 (Default: none)

view

Syntax	view <i>view-name</i> subtree <i>oid-value</i> no view <i>view-name</i> [subtree <i>oid-value</i>]
Context	config>system>security>snmp
Description	<p>This command configures a view. Views control the accessibility of a MIB object within the configured MIB view and subtree. Object identifiers (OIDs) uniquely identify MIB objects in the subtree. OIDs are organized hierarchically with specific values assigned by different organizations.</p> <p>Once the subtree (OID) is identified, a mask can be created to select the portions of the subtree to be included or excluded for access using this particular view. See the mask command. The view(s) configured with this command can subsequently be used in read, write, and notify commands which are used to assign specific access group permissions to created views and assigned to particular access groups.</p> <p>Multiple subtrees can be added or removed from a view name to tailor a view to the requirements of the user access group.</p> <p>The no view <i>view-name</i> command removes a view and all subtrees.</p> <p>The no view <i>view-name</i> subtree <i>oid-value</i> removes a sub-tree from the view name.</p>
Default	No views are defined.
Parameters	<p><i>view-name</i> — Enter a 1 to 32 character view name. (Default: <i>none</i>)</p> <p><i>oid-value</i> — The object identifier (OID) value for the <i>view-name</i>. This value, for example, 1.3.6.1.6.3.11.2.1, combined with the mask and include and exclude statements, configures the access available in the view.</p> <p>It is possible to have a view with different subtrees with their own masks and include and exclude statements. This allows for customizing visibility and write capabilities to specific user requirements.</p>

Show Commands

counters

Syntax `counters`

Context `show>snmp`

Description This command displays SNMP counters information. SNMP counters will continue to increase even when SNMP is shut down. Some internal modules communicate using SNMP packets.

Output **Counters Output** — The following table describes SNMP counters output fields.

Table 27: Counters Output Fields

Label	Description
<code>in packets</code>	Displays the total number of messages delivered to SNMP from the transport service.
<code>in gets</code>	Displays the number of SNMP get request PDUs accepted and processed by SNMP.
<code>in getnexts</code>	Displays the number of SNMP get next PDUs accepted and processed by SNMP.
<code>in sets</code>	Displays the number of SNMP set request PDUs accepted and processed by SNMP.
<code>out packets</code>	Displays the total number of SNMP messages passed from SNMP to the transport service.
<code>out get responses</code>	Displays the number of SNMP get response PDUs generated by SNMP.
<code>out traps</code>	Displays the number of SNMP Trap PDUs generated by SNMP.
<code>variables requested</code>	Displays the number of MIB objects requested by SNMP.
<code>variables set</code>	Displays the number of MIB objects set by SNMP as the result of receiving valid SNMP set request PDUs.

Sample Output

```
A:ALA-1# show snmp counters
=====
SNMP counters:
=====
  in packets : 463
```

```

-----
      in gets      : 93
      in getnexts : 0
      in sets     : 370
      out packets: 463
-----
      out get responses : 463
      out traps       : 0
      variables requested: 33
      variables set    : 497
=====
A:ALA-1#

```

counters

- Syntax** **counters**
- Context** show>snmp>streaming
- Description** This command displays counters information for the proprietary SNMP streaming protocol. Output: Counters Output - The following table describes SNMP streaming counters output fields.
- Output** **Counters Output** — The following table describes SNMP streaming counters output fields.

Table 28: Counters Output Fields

Label	Description
in getTables	Displays the number of GetTable request packets received.
in getManys	Displays the number of GetMany request packets received.
out responses	Displays the number of response packets sent.

Sample Output

```

*A:Dut-B# show snmp streaming counters
=====
STREAMING counters:
=====
      in getTables   : 772
      in getManys    : 26
-----
      out responses  : 848
=====

```

information

- Syntax** `information`
- Context** `show>system`
- Description** This command lists the SNMP configuration and statistics.
- Output** **System Information Output Fields** — The following table describes system information output fields.

Table 29: Show System Information Output Fields

Label	Description
System Name	The name configured for the device.
System Contact	The text string that identifies the contact name for the device.
System Location	The text string that identifies the location of the device.
System Coordinates	The text string that identifies the system coordinates for the device location. For example, "37.390 -122.0550" is read as latitude 37.390 north and longitude 122.0550 west.
System Up Time	The time since the last reboot.
SNMP Port	The port which SNMP sends responses to management requests.
SNMP Engine ID	The ID for either the local or remote SNMP engine to uniquely identify the SNMPv3 node.
SNMP Max Message Size	The maximum size SNMP packet generated by this node.
SNMP Admin State	Enabled — SNMP is administratively enabled. Disabled — SNMP is administratively disabled.
SNMP Oper State	Enabled — SNMP is operationally enabled. Disabled — SNMP is operationally disabled.
SNMP Index Boot Status	Persistent — Persistent indexes at the last system reboot was enabled. Disabled — Persistent indexes at the last system reboot was disabled.
SNMP Sync State	The state when the synchronization of configuration files between the primary and secondary CPMs finish.
Telnet/SSH/FTP Admin	Displays the administrative state of the Telnet, SSH, and FTP sessions.

Table 29: Show System Information Output Fields (Continued)

Label	Description
Telnet/SSH/FTP Oper	Displays the operational state of the Telnet, SSH, and FTP sessions.
BOF Source	The boot location of the BOF.
Image Source	<p><code>primary</code> – Specifies whether the image was loaded from the primary location specified in the BOF.</p> <p><code>secondary</code> – Specifies whether the image was loaded from the secondary location specified in the BOF.</p> <p><code>tertiary</code> – Specifies whether the image was loaded from the tertiary location specified in the BOF.</p>
Config Source	<p><code>primary</code> – Specifies whether the configuration was loaded from the primary location specified in the BOF.</p> <p><code>secondary</code> – Specifies whether the configuration was loaded from the secondary location specified in the BOF.</p> <p><code>tertiary</code> – Specifies whether the configuration was loaded from the tertiary location specified in the BOF.</p>
Last Booted Config File	Displays the URL and filename of the configuration file used for the most recent boot.
Last Boot Cfg Version	Displays the version of the configuration file used for the most recent boot.
Last Boot Config Header	Displays header information of the configuration file used for the most recent boot.
Last Boot Index Version	Displays the index version used in the most recent boot.
Last Boot Index Header	Displays the header information of the index used in the most recent boot.
Last Saved Config	Displays the filename of the last saved configuration.
Time Last Saved	Displays the time the configuration was most recently saved.
Changes Since Last Save	<p><code>Yes</code> – The configuration changed since the last save.</p> <p><code>No</code> – The configuration has not changed since the last save.</p>
Time Last Modified	Displays the time of the last modification.
Max Cfg/BOF Backup Rev	The maximum number of backup revisions maintained for a configuration file. This value also applies to the number of revisions maintained for the BOF file.

Table 29: Show System Information Output Fields (Continued)

Label	Description
Cfg-OK Script	URL – The location and name of the CLI script file executed following successful completion of the boot-up configuration file execution. N/A – No CLI script file is executed.
Cfg-OK Script Status	Successful/Failed – The results from the execution of the CLI script file specified in the Cfg-OK Script location. Not used – No CLI script file was executed.
Cfg-Fail Script	URL – The location and name of the CLI script file executed following a failed boot-up configuration file execution. Not used – No CLI script file was executed.
Cfg-Fail Script Status	Successful/Failed – The results from the execution of the CLI script file specified in the Cfg-Fail Script location. Not used – No CLI script file was executed.
Management IP address	The Management IP address of the node.
DNS Server	The DNS address of the node.
DNS Domain	The DNS domain name of the node.
BOF Static Routes	To – The static route destination. Next Hop – The next hop IP address used to reach the destination. Metric – Displays the priority of this static route versus other static routes. None – No static routes are configured.

Sample Output

```
A:ALA-1# show system information
=====
System Information
=====
System Name           : ALA-1
System Type           : 7750 SR-12
System Version        : B-0.0.I1204
System Contact        :
System Location       :
System Coordinates    :
System Active Slot    : A
System Up Time        : 1 days, 02:12:57.84 (hr:min:sec)

SNMP Port             : 161
SNMP Engine ID        : 0000197f00000479ff000000
SNMP Max Message Size : 1500
SNMP Admin State      : Enabled
SNMP Oper State       : Enabled
SNMP Index Boot Status : Not Persistent
SNMP Sync State       : OK

Telnet/SSH/FTP Admin  : Enabled/Enabled/Disabled
Telnet/SSH/FTP Oper   : Up/Up/Down

BOF Source             : cf1:
Image Source           : primary
Config Source         : primary
Last Booted Config File: ftp://172.22.184.249/./debby-sim1/debby-sim1-config.cfg
Last Boot Cfg Version  : THU FEB 15 16:58:20 2007 UTC
Last Boot Config Header: # TiMOS-B-0.0.I1042 both/i386 Alcatel-Lucent SR 7750
                        Copyright (c) 2000-2007 Alcatel-Lucent. # All rights
                        reserved. All use subject to applicable license
                        agreements. # Built on Sun Feb 11 19:26:23 PST 2007 by
                        builder in /rel0.0/I1042/panos/main # Generated THU
                        FEB 11 16:58:20 2007 UTC

Last Boot Index Version: N/A
Last Boot Index Header : # TiMOS-B-0.0.I1042 both/i386 Alcatel-Lucent SR 7750
                        Copyright (c) 2000-2007 Alcatel-Lucent. # All rights
                        reserved. All use subject to applicable license
                        agreements. # Built on Sun Feb 11 19:26:23 PST 2007 by
                        builder in /rel0.0/I1042/panos/main # Generated THU
                        FEB 15 16:58:20 2007 UTC

Last Saved Config     : N/A
Time Last Saved       : N/A
Changes Since Last Save: No
Max Cfg/BOF Backup Rev : 5
Cfg-OK Script         : N/A
Cfg-OK Script Status  : not used
Cfg-Fail Script       : N/A
Cfg-Fail Script Status : not used

Management IP Addr    : 192.168.2.121/20
DNS Server             : 192.168.1.246
DNS Domain            : eng.timetra.com
BOF Static Routes     :
```

access-group

Syntax `access-group group-name`

Context `show>system>security`

Description This command displays access-group information.

Output **System Information Output** — The following table describes the access-group output fields.

Table 30: Show System Security Access-Group Output Fields

Label	Description
Group name	The access group name.
Security model	The security model required to access the views configured in this node.
Security level	Specifies the required authentication and privacy levels to access the views configured in this node.
Read view	Specifies the view to read the MIB objects.
Write view	Specifies the view to configure the contents of the agent.
Notify view	Specifies the view to send a trap about MIB objects.
No. of access groups	The total number of configured access groups.

Sample Output

```
A:ALA-1# show system security access-group
=====
Access Groups
=====
group name      security  security  read      write     notify
                model    level    view      view      view
-----
snmp-ro        snmpv1   none     no-security      no-security
snmp-ro        snmpv2c  none     no-security      no-security
snmp-rw        snmpv1   none     no-security      no-security
snmp-rw        snmpv2c  none     no-security      no-security
snmp-rwa       snmpv1   none     iso              iso
snmp-rwa       snmpv2c  none     iso              iso
snmp-trap      snmpv1   none     no-security      iso
snmp-trap      snmpv2c  none     no-security      iso
-----
No. of Access Groups: 8
=====
A:ALA-1#

A:ALA-1# show system security access-group detail
```

```

=====
Access Groups
=====
group name      security  security  read      write     notify
                model     level     view      view      view
-----
snmp-ro        snmpv1   none      no-security          no-security
-----
No. of Access Groups:
...
=====
A:ALA-1#

```

authentication

- Syntax** **authentication [statistics]**
- Context** show>system>security
- Description** This command displays authentication information.
- Output** **Authentication Output** — The following table describes the authentication output fields.

Label	Description
sequence	The authentication order in which password authentication, authorization, and accounting is attempted among RADIUS, TACACS+, and local passwords.
server address	The address of the RADIUS, TACACS+, or local server.
status	The status of the server.
type	The type of server.
timeout (secs)	Number of seconds the server will wait before timing out.
single connection	Specifies whether a single connection is established with the server. The connection is kept open and is used by all the TELNET/SSH/FTP sessions for AAA operations.
retry count	The number of attempts to retry contacting the server.
radius admin status	The administrative status of the RADIUS protocol operation.
tacplus admin status	The administrative status of the TACACS+ protocol operation.

Label	Description (Continued)
health check	Specifies whether the RADIUS and TACACS+ servers will be periodically monitored. Each server will be contacted every 30 seconds. If in this process a server is found to be unreachable, or a previously unreachable server starts responding, based on the type of the server, a trap will be sent.
No. of Servers	The total number of servers configured.

Sample Output

```
A:ALA-49>show>system>security# authentication
=====
Authentication                sequence : radius tacplus local
=====
server address  status  type    timeout(secs)  single connection  retry count
-----
10.10.10.103    up      radius  5              n/a                 5
10.10.0.1       up      radius  5              n/a                 5
10.10.0.2       up      radius  5              n/a                 5
10.10.0.3       up      radius  5              n/a                 5
-----
radius admin status : down
tacplus admin status : up
health check        : enabled
-----
No. of Servers: 4
=====
A:ALA-49>show>system>security#
```

communities

Syntax	communities
Context	show>system>security
Description	This command lists SNMP communities and characteristics.
Output	Communities Output — The following table describes the communities output fields.

Sample Output

Table 31: Show Communities Output Fields

Label	Description
Community	The community string name for SNMPv1 and SNMPv2c access only.
Access	r – The community string allows read-only access. rw – The community string allows read-write access. rwa – The community string allows read-write access.
View	mgmt – The unique SNMP community string assigned to the management router. The view name.
Version	The SNMP version.
Group Name	The access group name.
No of Communities	The total number of configured community strings.

```
A:ALA-1# show system security communities
=====
Communities
=====
community      access  view          version  group name
-----
private        rw      iso           v1 v2c   snmp-rwa
public         r       no-security   v1 v2c   snmp-ro
rwa            rwa    n/a           v2c     snmp-trap
-----
No. of Communities: 3
=====
A:ALA-1#
```

password-options

- Syntax** password-options
- Context** show>system>security
- Description** This command displays password options.

Output Password-Options Output — The following table describes password-options output fields.

Label	Description
Password aging in days	Number of days a user password is valid before the user must change his password.
Number of invalid attempts permitted per login	Displays the maximum number of unsuccessful login attempts allowed for a user.
Time in minutes per login attempt	Displays the time in minutes that user is to be locked out.
Lockout period (when threshold breached)	Displays the number of minutes the user is locked out if the threshold of unsuccessful login attempts has exceeded.
Authentication order	Displays the most preferred method to authenticate and authorize a user.
Configured complexity options	Displays the complexity requirements of locally administered passwords, HMAC-MD5-96, HMAC-SHA-96 and DES-keys configured in the authentication section.
Minimum password length	Displays the minimum number of characters required in the password.

Sample Output

```
A:ALA-48>show>system>security# password-options
=====
Password Options
=====
Password aging in days                : 365
Number of invalid attempts permitted per login : 5
Time in minutes per login attempt      : 5
Lockout period (when threshold breached) : 20
Authentication order                  : radius tacplus local
Configured complexity options          :
Minimum password length                : 8
=====
A:ALA-48>show>system>security#
```

per-peer-queuing

Syntax	per-peer-queuing
Context	show>system>security
Description	This command displays displays the number of queues in use by the Qchip, which in turn is used by PPQ, CPM filter, SAP, etc.

Output **Per-Peer_Queueing Output** — The following table describes the per-peer-queueing output fields.

Label	Description
Per Peer Queueing	Displays whether per-peer-queueing is enabled or disabled. When enabled, a peering session is established and the router will automatically allocate a separate CPM hardware queue for that peer. When disabled, no hardware queueing per peer occurs.
Total Num of Queues	Displays the total number of CPM hardware queues.
Num of Queues In Use	Displays the number of CPM hardware queues that are in use.

Sample Output

```
A:ALA-48>show>system>security# per-peer-queueing
=====
CPM Hardware Queueing
=====
Per Peer Queueing      : Enabled
Total Num of Queues    : 8192
Num of Queues In Use   : 0
=====
A:ALA-48>show>system>security#
```

profile

- Syntax** `profile [profile-name]`
- Context** `show>system>security`
- Description** This command displays user profiles for CLI command tree permissions.
- Parameters** *profile-name* — Specify the profile name to display information about a single user profile. If no profile name is displayed, the entire list of profile names are listed.
- Output** **Profile Output** — The following table describes the profile output fields.

Label	Description
User Profile	<code>default</code> — The action to be given to the user profile if none of the entries match the command.
	<code>administrative</code> — specifies the administrative state for this profile.
Def. Action	<code>none</code> — No action is given to the user profile when none of the entries match the command.
	<code>permit-all</code> — The action to be taken when an entry matches the command.
Entry	10 - 80 — Each entry represents the configuration for a system user.
Description	A text string describing the entry.

Label	Description
Match Command	<p>administrative – Enables the user to execute all commands.</p> <p>configure system security – Enables the user to execute the config system security command.</p> <p>enable-admin – Enables the user to enter a special administrative mode by entering the enable-admin command.</p> <p>exec – Enables the user to execute (exec) the contents of a text file as if they were CLI commands entered at the console.</p> <p>exit – Enables the user to execute the exit command.</p> <p>help – Enables the user to execute the help command.</p> <p>logout – Enables the user to execute the logout command.</p> <p>password – Enables the user to execute the password command.</p> <p>show config – Enables the user to execute the show config command.</p> <p>show – Enables the user to execute the show command.</p> <p>show system security – Enables the user to execute the show system security command.</p>
Action	<p>permit – Enables the user access to all commands.</p> <p>deny-all – Denies the user access to all commands.</p>

```
A:ALA-48>config>system>snmp# show system security profile
=====
User Profile
=====
User Profile : test
Def. Action  : none
-----
Entry       : 1
Description :
Match Command:
Action      : unknown
=====
User Profile : default
Def. Action  : none
-----
Entry       : 10
Description :
Match Command: exec
Action      : permit
-----
Entry       : 20
Description :
Match Command: exit
```

```

Action      : permit
-----
Entry       : 30
Description :
Match Command: help
Action      : permit
-----
...
-----
Entry       : 80
Description :
Match Command: enable-admin
Action      : permit
=====

User Profile : administrative
Def. Action  : permit-all
-----
Entry       : 10
Description :
Match Command: configure system security
Action      : permit
-----
Entry       : 20
Description :
Match Command: show system security
Action      : permit
=====

No. of profiles: 3
=====
A:ALA-48>config>system>snmp#

```

ssh

- Syntax** `ssh`
- Context** `show>system>security`
- Description** This command displays all the SSH sessions as well as the SSH status and fingerprint.
- Output** **SSH Options Output** — The following table describes SSH output fields.

Table 32: Show SSH Output Fields

Label	Description
SSH status	SSH is enabled — Displays that SSH server is enabled. SSH is disabled — Displays that SSH server is disabled.
Key fingerprint	The key fingerprint is the server's identity. Clients trying to connect to the server verify the server's fingerprint. If the server fingerprint is not known, the client may not continue with the SSH session since the server might be spoofed.

Table 32: Show SSH Output Fields (Continued)

Label	Description
Connection	The IP address of the connected router(s) (remote client).
Encryption	des — Data encryption using a private (secret) key. 3des — An encryption method that allows proprietary information to be transmitted over untrusted networks.
Username	The name of the user.
Number of SSH sessions	The total number of SSH sessions.

Sample output

```
A:ALA-7# show system security ssh
SSH is enabled
Key fingerprint: 34:00:f4:97:05:71:aa:b1:63:99:dc:17:11:73:43:83
=====
Connection      Encryption      Username
=====
192.168.5.218    3des           admin
-----
Number of SSH sessions : 1
=====
A:ALA-7#

A:ALA-49>config>system>security# show system security ssh

SSH is disabled

A:ALA-49>config>system>security#
```

user

- Syntax** **users** [*user-id*] [**detail**]
- Context** show>system>security
- Description** This command displays user information.
- Output** **User Output** — The following table describes user information output fields.

Table 33: Show User Output Fields

Label	Description
User ID	The name of a system user.

Table 33: Show User Output Fields (Continued)

Label	Description
Need New PWD	Yes — The user must change his password at the next login. No — The user is not forced to change his password at the next login.
User Permission	Console — Specifies whether the user is permitted console/Telnet access. FTP — Specifies whether the user is permitted FTP access. SNMP — Specifies whether the user is permitted SNMP access.
Password expires	The date on which the current password expires.
Attempted logins	The number of times the user has attempted to login irrespective of whether the login succeeded or failed.
Failed logins	The number of unsuccessful login attempts.
Local Conf.	Y — Password authentication is based on the local password database. N — Password authentication is not based on the local password database.

Sample Output

```
A:ALA-1# show system security user
=====
Users
=====
user id          need   user permissions  password   attempted failed  local
                  new pwd console ftp snmp  expires   logins   logins  conf
-----
admin            n      y      n   n   never    2        0       y
testuser        n      n      n   y   never    0        0       y
-----
Number of users : 2
```

view**Syntax** `view [view-name] [detail]`**Context** `show>system>security`**Description** This command lists one or all views and permissions in the MIB-OID tree.

Output **System Security View Output** — The following table describes system security view output fields.

Table 34: Show System Security View Output Fields

Label	Description
View name	The name of the view. Views control the accessibility of a MIB object within the configured MIB view and subtree.
OID tree	The Object Identifier (OID) value. OIDs uniquely identify MIB objects in the subtree.
Mask	The mask value and the mask type, along with the <i>oid-value</i> configured in the view command, determines the access of each sub-identifier of an object identifier (MIB subtree) in the view.
Permission	Included — Specifies to include MIB subtree objects. Excluded — Specifies to exclude MIB subtree objects.
No. of Views	The total number of configured views.
Group name	The access group name.

Sample Output

```
A:ALA-1# show system security view
=====
Views
=====
view name      oid tree      mask          permission
-----
iso            1             included
no-security    1             included
no-security    1.3.6.1.6.3   excluded
no-security    1.3.6.1.6.3.10.2.1 included
no-security    1.3.6.1.6.3.11.2.1 included
no-security    1.3.6.1.6.3.15.1.1 included
-----
No. of Views: 6
=====
A:ALA-1#
```

```
A:ALA-1# show system security view no-security detail
=====
Views
=====
view name      oid tree      mask          permission
-----
no-security    1             included
no-security    1.3.6.1.6.3   excluded
no-security    1.3.6.1.6.3.10.2.1 included
```



```
no-security      1.3.6.1.6.3.11.2.1      included
no-security      1.3.6.1.6.3.15.1.1      included
-----
No. of Views: 5
=====
no-security used in
=====
group name
-----
snmp-ro
snmp-rw
=====
A:ALA-1#
```

Show Commands

Event and Accounting Logs

In This Chapter

This chapter provides information about configuring event and accounting logs in the system.

Topics in this chapter include:

- [Logging Overview on page 332](#)
- [Log Destinations on page 334](#)
- [Event Logs on page 339](#)
 - [Event Sources on page 340](#)
 - [Event Control on page 341](#)
 - [Log Manager and Event Logs on page 343](#)
 - [Event Filter Policies on page 344](#)
 - [Event Log Entries on page 345](#)
 - [Simple Logger Event Throttling on page 347](#)
 - [Default System Log on page 348](#)
- [Accounting Logs on page 349](#)
 - [Accounting Records on page 349](#)
 - [Accounting Files on page 365](#)
 - [Design Considerations on page 365](#)
- [Configuration Notes on page 371](#)

Logging Overview

The two primary types of logging supported in the OS are event logging and accounting logs.

Event logging controls the generation, dissemination and recording of system events for monitoring status and troubleshooting faults within the system. The OS groups events into three major categories or event sources:

- Security events — Events that pertain to attempts to breach system security.
- Change events — Events that pertain to the configuration and operation of the node.
- Main events — Events that pertain to applications that are not assigned to other event categories/sources.
- Debug events — Events that pertain to trace or other debugging information.

The following are events within the OS and have the following characteristics:

- A time stamp in UTC or local time.
- The generating application.
- A unique event ID within the application.
- The VRF-ID.
- A subject identifying the affected object.
- A short text description.

Event control assigns the severity for each application event and whether the event should be generated or suppressed. The severity numbers and severity names supported in the OS conform to ITU standards M.3100 X.733 & X.21 and are listed in [Table 35](#).

Table 35: Event Severity Levels

Severity Number	Severity Name
1	cleared
2	indeterminate (info)
3	critical
4	major
5	minor
6	warning

Events that are suppressed by event control will not generate any event log entries. Event control maintains a count of the number of events generated (logged) and dropped (suppressed) for each application event. The severity of an application event can be configured in event control.

An event log within the OS associates the event sources with logging destinations. Examples of logging destinations include, the console session, a specific telnet or SSH session, memory logs, file destinations, SNMP trap groups and syslog destinations. A log filter policy can be associated with the event log to control which events will be logged in the event log based on combinations of application, severity, event ID range, VRF ID, and the subject of the event.

The OS accounting logs collect comprehensive accounting statistics to support a variety of billing models. The routers collect accounting data on services and network ports on a per-service class basis. In addition to gathering information critical for service billing, accounting records can be analyzed to provide insight about customer service trends for potential service revenue opportunities. Accounting statistics on network ports can be used to track link utilization and network traffic pattern trends. This information is valuable for traffic engineering and capacity planning within the network core.

Accounting statistics are collected according to the parameters defined within the context of an accounting policy. Accounting policies are applied to customer Service Access Points (SAPs) and network ports. Accounting statistics are collected by counters for individual service queues defined on the customer's SAP or by the counters within forwarding class (FC) queues defined on the network ports.

The type of record defined within the accounting policy determines where a policy is applied, what statistics are collected and time interval at which to collect statistics.

The only supported destination for an accounting log is a compact flash system device (cf1 or cf2). Accounting data is stored within a standard directory structure on the device in compressed XML format.

Log Destinations

Both event logs and accounting logs use a common mechanism for referencing a log destination. routers support the following log destinations:

- [Console on page 334](#)
- [Session on page 334](#)
- [Memory Logs on page 334](#)
- [Log Files on page 335](#)
- [SNMP Trap Group on page 337](#)
- [Syslog on page 337](#)

Only a single log destination can be associated with an event log or with an accounting log. An event log can be associated with multiple event sources, but it can only have a single log destination.

A file destination is the only type of log destination that can be configured for an accounting log.

Console

Sending events to a console destination means the message will be sent to the system console. The console device can be used as an event log destination.

Session

A session destination is a temporary log destination which directs entries to the active telnet or SSH session for the duration of the session. When the session is terminated, for example, when the user logs out, the event log is removed. Event logs configured with a session destination are not stored in the configuration file. Event logs can direct log entries to the session destination.

Memory Logs

A memory log is a circular buffer. When the log is full, the oldest entry in the log is replaced with the new entry. When a memory log is created, the specific number of entries it can hold can be specified, otherwise it will assume a default size. An event log can send entries to a memory log destination.

Log Files

Log files can be used by both event logs and accounting logs and are stored on the compact flash devices (specifically cf1: or cf2:) in the file system. It is recommended that event and accounting logs not be configured on the cf3: device that is used for software images and bootup configuration.

A log file is identified with a single log file ID, but a log file will generally be composed of a number individual files in the file system. A log file is configured with a rollover parameter, expressed in minutes, which represents the length of time an individual log file should be written to before a new file is created for the relevant log file ID. The rollover time is checked only when an update to the log is performed. Thus, complying to this rule is subject to the incoming rate of the data being logged. For example, if the rate is very low, the actual rollover time may be longer than the configured value.

The retention time for a log file specifies the amount of time the file should be retained on the system based on the creation date and time of the file.

When a log file is created, only the compact flash device for the log file is specified. Log files are created in specific subdirectories with standardized names depending on the type of information stored in the log file.

Event log files are always created in the `\log` directory on the specified compact flash device. The naming convention for event log files is:

```
log eeff-timestamp
```

where:

ee is the event log ID

ff is the log file destination ID

timestamp is the timestamp when the file is created in the form of *yyyymmdd-hhmmss* where:

yyyy is the four-digit year (for example, 2007)

mm is the two digit number representing the month (for example, 12 for December)

dd is the two digit number representing the day of the month (for example, 03 for the 3rd of the month)

hh is the two digit hour in a 24-hour clock (for example, 04 for 4 a.m.)

mm is the two digit minute (for example, 30 for 30 minutes past the hour)

ss is the two digit second (for example, 14 for 14 seconds)

Log Destinations

Accounting log files are created in the `\act-collect` directory on a compact flash device (specifically *cf1* or *cf2*). The naming convention for accounting log files is nearly the same as for log files except the prefix **act** is used instead of the prefix **log**. The naming convention for accounting logs is:

```
act aaff-timestamp.xml.gz
```

where:

aa is the accounting policy ID

ff is the log file destination ID

timestamp is the timestamp when the file is created in the form of *yyyymmdd-hhmmss* where:

yyyy is the four-digit year (for example, 2007)

mm is the two digit number representing the month (for example, 12 for December)

dd is the two digit number representing the day of the month (for example, 03 for the 3rd of the month)

hh is the two digit hour in a 24-hour clock (for example, 04 for 4 a.m.)

mm is the two digit minute (for example, 30 for 30 minutes past the hour)

ss is the two digit second (for example, 14 for 14 seconds)

Accounting logs are `.xml` files created in a compressed format and have a `.gz` extension.

The `\act-collect` directory is where active accounting logs are written. When an accounting log is rolled over, the active file is closed and archived in the `\act` directory before a new active accounting log file created in `\act-collect`.

SNMP Trap Group

An event log can be configured to send events to SNMP trap receivers by specifying an SNMP trap group destination.

An SNMP trap group can have multiple trap targets. Each trap target can have different operational parameters.

A trap destination has the following properties:

- The IP address of the trap receiver.
- The UDP port used to send the SNMP trap.
- SNMP version (v1, v2c, or v3) used to format the SNMP notification.
- SNMP community name for SNMPv1 and SNMPv2c receivers.
- Security name and level for SNMPv3 trap receivers.

For SNMP traps that will be sent out-of-band through the Management Ethernet port on the SF/CPM, the source IP address of the trap is the IP interface address defined on the Management Ethernet port. For SNMP traps that will be sent in-band, the source IP address of the trap is the system IP address of the router.

Each trap target destination of a trap group receives the identical sequence of events as defined by the log ID and the associated sources and log filter applied.

Syslog

An event log can be configured to send events to one syslog destination. Syslog destinations have the following properties:

- Syslog server IP address.
- The UDP port used to send the syslog message.
- The Syslog Facility Code (0 - 23) (default 23 - local 7).
- The Syslog Severity Threshold (0 - 7) - events exceeding the configured level will be sent.

Because syslog uses eight severity levels whereas the router uses six internal severity levels, the severity levels are mapped to syslog severities. [Table 36](#) displays the severity level mappings to syslog severities.

Table 36: Router to Syslog Severity Level Mappings

Severity Level	Numerical Severity (highest to lowest)	Syslog Configured Severity	Definition
	0	emergency	System is unusable
3	1	alert	Action must be taken immediately
4	2	critical	Critical conditions
5	3	error	Error conditions
6	4	warning	Warning conditions
	5	notice	Normal but significant condition
1 cleared 2 indeterminate	6	info	Informational messages
	7	debug	Debug-level messages

Event Logs

Event logs are the means of recording system generated events for later analysis. Events are messages generated by the system by applications or processes within the router.

Figure 8 depicts a function block diagram of event logging.

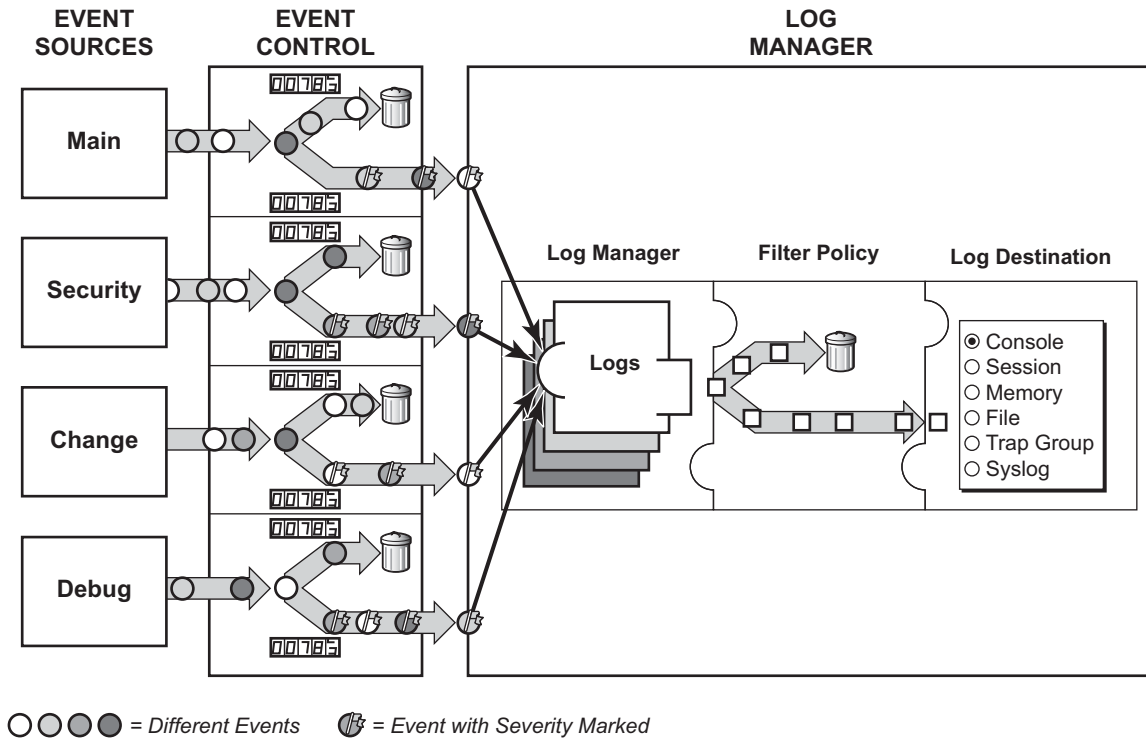

CLI0001B

Figure 8: Event Logging Block Diagram

Event Sources

In [Figure 8](#), the event sources are the main categories of events that feed the log manager.

- Security — The security event source is all events that affect attempts to breach system security such as failed login attempts, attempts to access MIB tables to which the user is not granted access or attempts to enter a branch of the CLI to which access has not been granted. Security events are generated by the SECURITY application and the authenticationFailure event in the SNMP application.
- Change — The change activity event source is all events that directly affect the configuration or operation of the node. Change events are generated by the USER application. The Change event stream also includes the tmnxConfigModify (#2006), tmnxConfigCreate (#2007), tmnxConfigDelete (#2008) and tmnxStateChange (#2009) change events from the SYSTEM application.
- Debug — The debug event source is the debugging configuration that has been enabled on the system. Debug events are generated by the DEBUG application.
- Main — The main event source receives events from all other applications within the router.

Examples of applications within the system include IP, MPLS, OSPF, CLI, services, etc. The following example displays a partial sample of the **show log applications** command output which displays all applications.

```
*A:ALA-48# show log applications
=====
Log Event Application Names
=====
Application Name
-----
...
BGP
CCAG
CFLOWD
CHASSIS
...
MPLS
MSDP
NTP
...
TOD
USER
VRRP
VRTR
=====
*A:ALA-48#
```

Event Control

Event control pre-processes the events generated by applications before the event is passed into the main event stream. Event control assigns a severity to application events and can either forward the event to the main event source or suppress the event. Suppressed events are counted in event control, but these events will not generate log entries as it never reaches the log manager.

Simple event throttling is another method of event control and is configured similarly to the generation and suppression options. See [Simple Logger Event Throttling on page 347](#).

Events are assigned a default severity level in the system, but the application event severities can be changed by the user.

Application events contain an event number and description that explains why the event is generated. The event number is unique within an application, but the number can be duplicated in other applications.

The following example, generated by querying event control for application generated events, displays a partial list of event numbers and names.

```
router# show log event-control
=====
Log Events
=====
Application
ID#      Event Name                               P  g/s    Logged    Dropped
-----
BGP:
  2001  bgpEstablished                          MI  gen     1         0
  2002  bgpBackwardTransition                    WA  gen     7         0
  2003  tBgpMaxPrefix90                          WA  gen     0         0
...
CCAG:
CFLOWD:
  2001  cflowdCreated                            MI  gen     1         0
  2002  cflowdCreateFailure                       MA  gen     0         0
  2003  cflowdDeleted                             MI  gen     0         0
...
CHASSIS:
  2001  cardFailure                               MA  gen     0         0
  2002  cardInserted                              MI  gen     4         0
  2003  cardRemoved                               MI  gen     0         0
...
'''
DEBUG:
L 2001  traceEvent                               MI  gen     0         0
DOT1X:
FILTER:
  2001  filterPBRPacketsDropped                  MI  gen     0         0
IGMP:
  2001  vRtrIcmpIfRxQueryVerMismatch             WA  gen     0         0
  2002  vRtrIcmpIfCModeRxQueryMismatch           WA  gen     0         0
IGMP_SNOOPING:
```

Event Logs

```
IP:
L 2001 clearRTMError          MI gen      0      0
L 2002 ipEtherBroadcast      MI gen      0      0
L 2003 ipDuplicateAddress     MI gen      0      0
...
ISIS:
  2001 vRtrIisisDatabaseOverload WA gen      0      0
```

Log Manager and Event Logs

Events that are forwarded by event control are sent to the log manager. The log manager manages the event logs in the system and the relationships between the log sources, event logs and log destinations, and log filter policies.

An event log has the following properties:

- A unique log ID
The log ID is a short, numeric identifier for the event log. A maximum of ten logs can be configured at a time.
- One or more log sources
The source stream or streams to be sent to log destinations can be specified. The source must be identified before the destination can be specified. The events can be from the main event stream, events in the security event stream, or events in the user activity stream.
- One event log destination
A log can only have a single destination. The destination for the log ID destination can be one of console, session, syslog, snmp-trap-group, memory, or a file on the local file system.
- An optional event filter policy
An event filter policy defines whether to forward or drop an event or trap-based on match criteria.

Event Filter Policies

The log manager uses event filter policies to allow fine control over which events are forwarded or dropped based on various criteria. Like other policies with the 7750 SR, filter policies have a default action. The default actions are either:

- Forward
- Drop

Filter policies also include a number of filter policy entries that are identified with an entry ID and define specific match criteria and a forward or drop action for the match criteria.

Each entry contains a combination of matching criteria that define the application, event number, router, severity, and subject conditions. The entry's action determines how the packets should be treated if they have met the match criteria.

Entries are evaluated in order from the lowest to the highest entry ID. The first matching event is subject to the forward or drop action for that entry.

Valid operators are displayed in [Table 37](#):

Table 37: Valid Filter Policy Operators

Operator	Description
eq	equal to
neq	not equal to
lt	less than
lte	less than or equal to
gt	greater than
gte	greater than or equal to

A match criteria entry can include combinations of:

- Equal to or not equal to a given system application.
- Equal to, not equal to, less than, less than or equal to, greater than or greater than or equal to an event number within the application.
- Equal to, not equal to, less than, less than or equal to, greater than or greater than or equal to a severity level.
- Equal to or not equal to a router name string or regular expression match.
- Equal to or not equal to an event subject string or regular expression match.

Event Log Entries

Log entries that are forwarded to a destination are formatted in a way appropriate for the specific destination whether it be recorded to a file or sent as an SNMP trap, but log event entries have common elements or properties. All application generated events have the following properties:

- A time stamp in UTC or local time.
- The generating application.
- A unique event ID within the application.
- A router name identifying the VRF-ID that generated the event.
- A subject identifying the affected object.
- A short text description.

The general format for an event in an event log with either a memory, console or file destination is as follows.

```
nnnn YYYY/MM/DD HH:MM:SS.SS <severity>:<application> # <event_id> <router-name> <subject>
description
```

The following is an event log example:

```
475 2006/11/27 00:19:40.38 WARNING: SNMP #2007 Base 1/1/1
"interface 1/1/1 came up"
```

The specific elements that compose the general format are described in [Table 38](#).

Table 38: Log Entry Field Descriptions

Label	Description
nnnn	The log entry sequence number.
YYYY/MM/DD	The UTC date stamp for the log entry. <i>YYYY</i> — Year <i>MM</i> — Month <i>DD</i> — Date
HH:MM:SS.SS	The UTC time stamp for the event. <i>HH</i> — Hours (24 hour format) <i>MM</i> — Minutes <i>SS.SS</i> — Seconds

Table 38: Log Entry Field Descriptions (Continued)

Label	Description
<severity>	The severity level name of the event. CLEARED — A cleared event (severity number 1). INFO — An indeterminate/informational severity event (severity level 2). CRITICAL — A critical severity event (severity level 3). MAJOR — A major severity event (severity level 4). MINOR — A minor severity event (severity level 5). WARNING — A warning severity event (severity 6).
<application>	The application generating the log message.
<event_id>	The application's event ID number for the event.
<router>	The router name representing the VRF-ID that generated the event.
<subject>	The subject/affected object for the event.
<description>	A text description of the event.

Simple Logger Event Throttling

Simple event throttling provides a mechanism to protect event receivers from being overloaded when a scenario causes many events to be generated in a very short period of time. A throttling rate, # events/# seconds, can be configured. Specific event types can be configured to be throttled. Once the throttling event limit is exceeded in a throttling interval, any further events of that type cause the dropped events counter to be incremented. Dropped events counts are displayed by the **show>log>event-control** context. Events are dropped before being sent to one of the logger event collector tasks. There is no record of the details of the dropped events and therefore no way to retrieve event history data lost by this throttling method.

A particular event type can be generated by multiple managed objects within the system. At the point this throttling method is applied the logger application has no information about the managed object that generated the event and cannot distinguish between events generated by object "A" from events generated by object "B". If the events have the same event-id, they are throttled regardless of the managed object that generated them. It also does not know which events may eventually be logged to destination log-id <n> from events that will be logged to destination log-id <m>.

Throttle rate applies commonly to all event types. It is not configurable for a specific event-type.

A timer task checks for events dropped by throttling when the throttle interval expires. If any events have been dropped, a TIMETRA-SYSTEM-MIB::tmnxTrapDropped notification is sent.

Default System Log

Log 99 is a pre-configured memory-based log which logs events from the main event source (not security, debug, etc.). Log 99 exists by default.

The following example displays the log 99 configuration.

```
ALA-1>config>log# info detail
#-----
echo "Log Configuration "
#-----
...
    snmp-trap-group 7
    exit
...
    log-id 99
        description "Default system log"
        no filter
        from main
        to memory 500
        no shutdown
    exit
-----
ALA-1>config>log#
```

Accounting Logs

Before an accounting policy can be created a target log file must be created to collect the accounting records. The files are stored in system memory on compact flash (*cf1:* or *cf2:*) in a compressed (tar) XML format and can be retrieved using FTP or SCP.

A file ID can only be assigned to either one event log ID or one accounting log.

Accounting Records

An accounting policy must define a record name and collection interval. Only one record name can be configured per accounting policy. Also, a record name can only be used in one accounting policy.

The record name, sub-record types, and default collection period for service and network accounting policies are shown below. [Table 41](#), [Table 42](#), and [Table 43](#) provide field descriptions.

Table 39: Accounting Record Name and Collection Periods

Record Name	Sub-Record Types	Accounting Object	Default Collection Period (minutes)
service-ingress-octets	sio	SAP	5
service-egress-octets	seo	SAP	5
service-ingress-packets	sip	SAP	5
service-egress-packets	sep	SAP	5
network-ingress-octets	nio	Network port	15
network-egress-octets	neo	Network port	15
network-egress-packets	nep	Network port	15
network-ingress-packets	nio	Network port	15
compact-service-ingress-octets	ctSio	SAP	5
combined-service-ingress	cmSipo	SAP	5
combined-network-ing-egr-octets	cmNio & cmNeo	Network port	15
combined-service-ing-egr-octets	cmSio & cmSeo	SAP	5
complete-network-ingr-egr	cpNipo & cpNepo	Network port	15
complete-service-ingress-egress	cpSipo & cpSepo	SAP	5
combined-sdp-ingress-egress	cmSdpipo and cmSdpepo	SDP and SDP binding	5
complete-sdp-ingress-egress	cmSdpipo, cmSdpepo, cpSdpipo and cpSdpepo	SDP and SDP binding	5

Table 39: Accounting Record Name and Collection Periods (Continued)

Record Name	Sub-Record Types	Accounting Object	Default Collection Period (minutes)
complete-subscriber-ingress-egress	cpSBipo & cpSBepo	Subscriber profile	5
aa-protocol	aaProt	AA ISA Group	15
aa-application	aaApp	AA ISA Group	15
aa-app-group	aaAppGrp	AA ISA Group	15
aa-subscriber-protocol	aaSubProt	Special study AA subscriber	15
aa-subscriber-application	aaSubApp	Special study AA subscriber	15
custom-record-aa-sub	aaSubCustom	AA subscriber	15
combined-mpls-lsp-egress	mplsLspEgr	LSP	5
combined-mpls-lsp-ingress	mplsLspIn	LSP	5
saa	saa png trc hop	SAA or SAA test	5
complete-ethernet-port	enet	Ethernet port	15

When creating accounting policies, one service accounting policy and one network accounting policy can be defined as default. If statistics collection is enabled on a SAP or network port and no accounting policy is applied, then the respective default policy is used. If no default policy is defined, then no statistics are collected unless a specifically defined accounting policy is applied.

Each accounting record name is composed of one or more sub-records which is in turn composed of multiple fields.

Refer to the Application Assurance Statistics Fields Generated per Record table in the 7750 SR-Series OS Integrated Services Adapter Guide for fields names for Application Assurance records.

Table 40: Accounting Record Name Details

Record Name	Sub-Record	Field	Field Description
Service-ingress-octets (sio) (**)	sio	svc	SvcId
		sap	SapId
		qid	QueueId
		hoo	OfferedHiPrioOctets
		hod	DroppedHiPrioOctets
		loo	LowOctetsOffered
		lod	LowOctetsDropped
		uco	UncoloredOctetsOffered
		iof	InProfileOctetsForwarded
		oof	OutOfProfileOctetsForwarded

Table 40: Accounting Record Name Details (Continued)

Record Name	Sub-Record	Field	Field Description
Service-egress-octets (seo) (**)	seo	svc	SvcId
		sap	SapId
		qid	QueueId
		iof	InProfileOctetsForwarded
		iod	InProfileOctetsDropped
		oof	OutOfProfileOctetsForwarded
		ood	OutOfProfileOctetsDropped
Service-ingress-packets (sip) (*) (**)	sip	svc	SvcId
		sap	SapId
		qid	QueueId
		hpo	HighPktsOffered
		hpd	HighPktsDropped
		lpo	LowPktsOffered
		lpd	LowPktsDropped
		ucp	UncoloredPacketsOffered
		ipf	InProfilePktsForwarded
		opf	OutOfProfilePktsForwarded
Service-egress-packets (sep) (*) (**)	sep	svc	SvcId
		sap	SapId
		qid	QueueId
		ipf	InProfilePktsForwarded
		ipd	InProfilePktsDropped
		opf	OutOfProfilePktsForwarded
		opd	OutOfProfilePktsDropped
Network-ingress-octets (nio)	nio	port	PortId
		qid	QueueId
		iof	InProfileOctetsForwarded
		iod	InProfileOctetsDropped
		oof	OutOfProfileOctetsForwarded
		ood	OutOfProfileOctetsDropped
Network-egress-octets (neo)	neo	port	PortId
		qid	QueueId
		iof	InProfileOctetsForwarded
		iod	InProfileOctetsDropped
		oof	OutOfProfileOctetsForwarded
		ood	OutOfProfileOctetsDropped

Table 40: Accounting Record Name Details (Continued)

Record Name	Sub-Record	Field	Field Description
Network-ingress-packets (nip)	nip	port	PortId
		qid	QueueId
		ipf	InProfilePktsForwarded
		ipd	InProfilePktsDropped
		opf	OutOfProfilePktsForwarded
		opd	OutOfProfilePktsDropped
Network Egress Packets (nep)	nep	port	PortId
		qid	QueueId
		ipf	InProfilePktsForwarded
		ipd	InProfilePktsDropped
		opf	OutOfProfilePktsForwarded
		opd	OutOfProfilePktsDropped
Compact-service-ingress-octets (ctSio)	ctSio	svc	SvcId
		sap	SapId
		qid	QueueId
		hoo	OfferedHiPrioOctets
		hod	DroppedHiPrioOctets
		loo	LowOctetsOffered
		lod	LowOctetsDropped
		uco	UncoloredOctetsOffered
Combined-service-ingress (cmSipo)	cmSipo	svc	SvcId
		sap	SapId
		qid	QueueId
		hpo	HighPktsOffered
		hpd	HighPktsDropped
		lpo	LowPktsOffered
		lpd	LowPktsDropped
		ucp	UncoloredPacketsOffered
		hoo	OfferedHiPrioOctets
		hod	DroppedHiPrioOctets
		loo	LowOctetsOffered
		lod	LowOctetsDropped
		uco	UncoloredOctetsOffered
		ipf	InProfilePktsForwarded
		opf	OutOfProfilePktsForwarded
		iof	InProfileOctetsForwarded
oof	OutOfProfileOctetsForwarded		

Table 40: Accounting Record Name Details (Continued)

Record Name	Sub-Record	Field	Field Description	
Combined-network-ing-egr-octets (cmNio & cmNeo)	cmNio	port	PortId	
		qid	QueueId	
		iof	InProfileOctetsForwarded	
		iod	InProfileOctetsDropped	
		oof	OutOfProfileOctetsForwarded	
		ood	OutOfProfileOctetsDropped	
	cmNeo	port	PortId	
		qid	QueueId	
		iof	InProfileOctetsForwarded	
		iod	InProfileOctetsDropped	
		oof	OutOfProfileOctetsForwarded	
		ood	OutOfProfileOctetsDropped	
	Combined-service-ingr-egr-octets (cmSio & CmSeo)	cmSio	svc	SvcId
			sap	SapId
qid			QueueId	
hoo			OfferedHiPrioOctets	
hod			DroppedHiPrioOctets	
loo			LowOctetsOffered	
lod			LowOctetsDropped	
uco			UncoloredOctetsOffered	
iof			InProfileOctetsForwarded	
oof			OutOfProfileOctetsForwarded	
cmSeo		svc	SvcId	
		sap	SapId	
		qid	QueueId	
		iof	InProfileOctetsForwarded	
		iod	InProfileOctetsDropped	
		oof	OutOfProfileOctetsForwarded	
		ood	OutOfProfileOctetsDropped	

Table 40: Accounting Record Name Details (Continued)

Record Name	Sub-Record	Field	Field Description
Complete-network-ingr-egr (cpNipo & cpNepo)	cpNipo	port	PortId
		qid	QueueId
		ipf	InProfilePktsForwarded
		ipd	InProfilePktsDropped
		opf	OutOfProfilePktsForwarded
		opd	OutOfProfilePktsDropped
		iof	InProfileOctetsForwarded
		iod	InProfileOctetsDropped
		oof	OutOfProfileOctetsForwarded
		ood	OutOfProfileOctetsDropped
	cpNepo	port	PortId
		qid	QueueId
		ipf	InProfilePktsForwarded
		ipd	InProfilePktsDropped
		opf	OutOfProfilePktsForwarded
		opd	OutOfProfilePktsDropped
		iof	InProfileOctetsForwarded
		iod	InProfileOctetsDropped
		oof	OutOfProfileOctetsForwarded
		ood	OutOfProfileOctetsDropped

Table 40: Accounting Record Name Details (Continued)

Record Name	Sub-Record	Field	Field Description
Complete-service-ingress-egress (cpSipo & cpSepo)	cpSipo	svc	SvcId
		sap	SapId
		qid	QueueId
		hpo	HighPktsOffered
		hpd	HighPktsDropped
		lpo	LowPktsOffered
		lpd	LowPktsDropped
		ucp	UncoloredPacketsOffered
		hoo	OfferedHiPrioOctets
		hod	DroppedHiPrioOctets
		loo	LowOctetsOffered
		lod	LowOctetsDropped
		uco	UncoloredOctetsOffered
		ipf	InProfilePktsForwarded
		opf	OutOfProfilePktsForwarded
		iof	InProfileOctetsForwarded
	oof	OutOfProfileOctetsForwarded	
	cpSepo	svc	SvcId
		sap	SapId
		qid	QueueId
		ipf	InProfilePktsForwarded
		ipd	InProfilePktsDropped
		opf	OutOfProfilePktsForwarded
		opd	OutOfProfilePktsDropped
		iof	InProfileOctetsForwarded
		iod	InProfileOctetsDropped
oof		OutOfProfileOctetsForwarded	
ood	OutOfProfileOctetsDropped		
Complete-sdp-ingress-egress (cpSdpipo & cpSdpepo)	cpSdpipo	sdp	SdpID
		tpf	TotalPacketsForwarded
		tpd	TotalPacketsDropped
		tof	TotalOctetsForwarded
		tod	TotalOctetsDropped
	cpSdpepo	sdp	SdpID
		tpd	TotalPacketsDropped
		tod	TotalOctetsDropped

Table 40: Accounting Record Name Details (Continued)

Record Name	Sub-Record	Field	Field Description
Combined-sdp-ingress-egress (cmSdpipo & cmSdpepo)	cmSdpipo	svc	SvcID
		sdp	SdpID
		tpf	TotalPacketsForwarded
		tpd	TotalPacketsDropped
		tof	TotalOctetsForwarded
		tod	TotalOctetsDropped
	cmSdpepo	svc	SvcID
		sdp	SdpID
		tpf	TotalPacketsForwarded
		tof	TotalOctetsForwarded
Complete-sdp-ingress-egress (cmSdpipo & cmsdpepo) (cpSdpip & cpSdpepo)	cmSdpipo	svc	SvcID
		sdp	SdpID
		tpf	TotalPacketsForwarded
		tpd	TotalPacketsDropped
		tof	TotalOctetsForwarded
		tod	TotalOctetsDropped
	cmSdpepo	svc	SvcID
		sdp	SdpID
		tpf	TotalPacketsForwarded
		tof	TotalOctetsForwarded
	cpSdpipo	sdp	SdpID
		tpf	TotalPacketsForwarded
		tpd	TotalPacketsDropped
		tof	TotalOctetsForwarded
		tod	TotalOctetsDropped
	cpSdpepo	sdp	SdpID
		tpf	TotalPacketsForwarded
		tof	TotalOctetsForwarded

Table 40: Accounting Record Name Details (Continued)

Record Name	Sub-Record	Field	Field Description
Complete-subscriber-ingress-egress (cpSBipo & cpSBepo) (cpSBipoooc & cpSBepoooc) ***	SubscriberInformation	subId	SubscriberId
		subProfile	SubscriberProfile
	Sla-Information****	svc	SvcId
		sap	SapId
		slaProfile	SlaProfile
	cpSBipo	qid	QueueId
		hpo	HighPktsOffered ****
		hpd	HighPktsDropped
		lpo	LowPktsOffered ****
		lpd	LowPktsDropped
		ucp	UncolouredPacketsOffered
		hoo	OfferedHiPrioOctets ****
		hod	DroppedHiPrioOctets
		loo	LowOctetsOffered ****
		lod	LowOctetsDropped
		apo	AllPktsOffered ****
		aoo	AllOctetsOffered ****
		uco	UncolouredOctetsOffered
		ipf	InProfilePktsForwarded
		opf	OutOfProfilePktsForwarded
		iof	InProfileOctetsForwarded
		oof	OutOfProfileOctetsForwarded
		v4pf	IPv4PktsForwarded
		v6pf	IPv6PktsForwarded
		v4pd	IPv4PktsDropped
		v6pd	IPv6PktsDropped
		v4of	IPv4OctetsForwarded
		v6of	IPv6OctetsForwarded
	v4od	IPv4OctetsDropped	
	v6od	IPv6OctetsDropped	
	cpSBepo	qid	QueueId
		ipf	InProfilePktsForwarded
		ipd	InProfilePktsDropped
		opf	OutOfProfilePktsForwarded
		opd	OutOfProfilePktsDropped
		iof	InProfileOctetsForwarded
		iod	InProfileOctetsDropped
		oof	OutOfProfileOctetsForwarded
	ood	OutOfProfileOctetsDropped	

Table 40: Accounting Record Name Details (Continued)

Record Name	Sub-Record	Field	Field Description
		v4pf	IPv4PktsForwarded
		v6pf	IPv6PktsForwarded
		v4pd	IPv4PktsDropped
		v6pd	IPv6PktsDropped
		v4of	IPv4OctetsForwarded
		v6of	IPv6OctetsForwarded
		v4od	IPv4OctetsDropped
		v6od	IPv6OctetsDropped

Table 40: Accounting Record Name Details (Continued)

Record Name	Sub-Record	Field	Field Description
(continued) Complete-subscriber-ingress-egress (cpSBipo & cpSBepo) (cpSBipoooc & cpSBepooc) ***	cpSBipoooc ***	cid	OverrideCounterId
		apo	AllPktsOffered
		hpd	HighPktsDropped
		lpd	LowPktsDropped
		aoo	AllOctetsOffered
		hod	DroppedHiPrioOctets
		lod	LowOctetsDropped
		ipf	InProfilePktsForwarded
		opf	OutOfProfilePktsForwarded
		iof	InProfileOctetsForwarded
		oof	OutOfProfileOctetsForwarded
		ucp	UncolouredPacketsOffered
		uco	UncolouredOctetsOffered
	cpSBepooc ***	cid	OverrideCounterId
		ipf	InProfilePktsForwarded
		ipd	InProfilePktsDropped
		ofp	OutOfProfilePktsForwarded
		opd	OutOfProfilePktsDropped
		ipd	InProfileOctetsForwarded
		iod	InProfileOctetsDropped
oof		OutOfProfileOctetsForwarded	
ood	OutOfProfileOctetsDropped		
saa	saa	tmd	TestMode
		own	OwnerName
		tst	TestName
		png	PingRun subrecord
		rid	RunIndex
		trr	TestRunResult
		mnr	MinRtt
		mxr	MaxRtt
		avr	AverageRtt
		rss	RttSumOfSquares
		pbr	ProbeResponses
		spb	SentProbes
		mnt	MinOutTt
		mxt	MaxOutTt
		avt	AverageOutTt

Table 40: Accounting Record Name Details (Continued)

Record Name	Sub-Record	Field	Field Description
		tss	OutTtSumOfSquares
		mni	MinInTt
		mxi	MaxInTt
		avi	AverageInTt
		iss	InTtSumOfSqrs
		ojt	OutJitter
		ijt	InJitter
		rjt	RtJitter
		prt	ProbeTimeouts
		prf	ProbeFailures
	trc	rid	RunIndex
		trr	TestRunResult
		lgp	LastGoodProbe
	hop	hop	TraceHop
		hid	HopIndex
		mnr	MinRtt
		mrx	MaxRtt
		avr	AverageRtt
		rss	RttSumOfSquares
		pbr	ProbeResponses
		spb	SentProbes
		mnt	MinOutTt
		mxt	MaxOutTt
		avt	AverageOutTt
		tss	OutTtSumOfSquares
		mni	MinInTt
		mxi	MaxInTt
		avi	AverageInTt
		iss	InTtSumOfSqrs
		ojt	OutJitter
		ijt	InJitter
		rjt	RtJitter
		prt	ProbeTimeouts
		prf	ProbeFailures
tat		TraceAddressType	
tav		TraceAddressValue	

Table 40: Accounting Record Name Details (Continued)

Record Name	Sub-Record	Field	Field Description
Complete-ethernet-port (enet)	enet	port	PortId
		to	EtherStatsOctets
		tp	EtherStatsPkts
		de	EtherStatsDropEvents
		tbcp	EtherStatsBroadcastPkts
		mcp	EtherStatsMulticastPkts
		cae	EtherStatsCRCAlignErrors
		up	EtherStatsUndersizePkts
		op	EtherStatsOversizePkts
		fgm	EtherStatsFragments
		jab	EtherStatsJabbers
		col	EtherStatsCollisions
		p64o	EtherStatsPkts64Octets
		p127o	EtherStatsPkts65to127Octets
		p255o	EtherStatsPkts128to255Octets
		p511o	EtherStatsPkts256to511Octets
		p1023o	EtherStatsPkts512to1023Octets
		p1518o	EtherStatsPkts1024to1518Octets
		po1518o	EtherStatsPktsOver1518Octets
		ae	Dot3StatsAlignmentErrors
		fe	Dot3StatsFCSErrors
		scf	Dot3StatsSingleCollisionFrames
		mcf	Dot3StatsMultipleCollisionFrames
		sqe	Dot3StatsSQETestErrors
		dt	Dot3StatsDeferredTransmissions
		lcc	Dot3StatsLateCollisions
		exc	Dot3StatsExcessiveCollisions
		imt	Dot3StatsInternalMacTransmitErrors
		cse	Dot3StatsCarrierSenseErrors
		ftl	Dot3StatsFrameTooLongs
		imre	Dot3StatsInternalMacReceiveErrors
		se	Dot3StatsSymbolErrors
ipf	Dot3InPauseFrames		
opf	Dot3OutPauseFrames		

(*) For a SAP in AAL5 SDU mode, packet counters refer to the number of SDU.

(*) For a SAP in N-to-1 cell mode, packet counters refer to the number of cells.

(**) The number of octets in an ATM sap excludes the Header Error Control (HEC) byte, thus meaning each packet/cell has only 52 bytes instead of the usual 53.

(***) If override counters on the HSMDA are configured (see the 7750 SR Quality of Service Guide).

(****) Not used to identify stats from HSMDA due to MDA architecture. If the statistics are from HSMDA: apo, aoo else lpo/hpo, loo/hoo.

Table 41, Table 42, and Table 43 provide field descriptions.

Table 41: Policer Stats Field Descriptions

Field	Field Description
pid	PolicerId
statmode	PolicerStatMode
aod	AllOctetsDropped
aof	AllOctetsForwarded
aoo	AllOctetsOffered
apd	AllPacketsDropped
apf	AllPacketsForwarded
apo	AllPacketsOffered
hod	HighPriorityOctetsDropped
hof	HighPriorityOctetsForwarded
hoo	HighPriorityOctetsOffered
hpd	HighPriorityPacketsDropped
hpf	HighPriorityPacketsForwarded
hpo	HighPriorityPacketsOffered
iod	InProfileOctetsDropped
iof	InProfileOctetsForwarded
ioo	InProfileOctetsOffered
ipd	InProfilePacketsDropped
ipf	InProfilePacketsForwarded
ipo	InProfilePacketsOffered
lod	LowPriorityOctetsDropped
lof	LowPriorityOctetsForwarded
loo	LowPriorityOctetsOffered
lpd	LowPriorityPacketsDropped
lpf	LowPriorityPacketsForwarded
lpo	LowPriorityPacketsOffered
opd	OutOfProfilePacketsDropped
opf	OutOfProfilePacketsForwarded
opo	OutOfProfilePacketsOffered
ood	OutOfProfileOctetsDropped

Table 41: Policer Stats Field Descriptions (Continued)

Field	Field Description
oof	OutOfProfileOctetsForwarded
ooo	OutOfProfileOctetsOffered
uco	UncoloredOctetsOffered
v4po	IPv4PktsOffered *
v4oo	IPv4OctetsOffered *
v6po	IPv6PktsOffered *
v6oo	IPv6OctetsOffered *
v4pf	IPv4PktsForwarded *
v6pf	IPv6PktsForwarded *
v4pd	IPv4PktsDropped *
v6pd	IPv6PktsDropped *
v4of	IPv4OctetsForwarded *
v6of	IPv6OctetsForwarded *
v4od	IPv4OctetsDropped *
v6od	IPv6OctetsDropped *

* Enhanced Subscriber Management (ESM) only.

Table 42: Queue Group Record Types

Record Name	Description
qgone	PortQueueGroupOctetsNetworkEgress
qgosi	PortQueueGroupOctetsServiceIngress
qgose	PortQueueGroupOctetsServiceEgress
qgpne	PortQueueGroupPacketsNetworkEgress
qgpsi	PortQueueGroupPacketsServiceIngress
qgpse	PortQueueGroupPacketsServiceEgress
fpqgosi	ForwardingPlaneQueueGroupOctetsServiceIngress
fpqgoni	ForwardingPlaneQueueGroupOctetsNetworkIngress
fpqgpsi	ForwardingPlaneQueueGroupPacketsServiceIngress
fpqgpni	ForwardingPlaneQueueGroupPacketsNetworkIngress

Table 43: Queue Group Record Type Fields

Field	Field Description
data port	Port (used for port based Queue Groups)
member-port	LAGMemberPort (used for port based Queue Groups)
data slot	Slot (used for Forwarding Plane based Queue Groups)
forwarding-plane	ForwardingPlane (used for Forwarding Plane based Queue Groups)
queue-group	QueueGroupName

Table 43: Queue Group Record Type Fields (Continued)

Field	Field Description
instance	QueueGroupInstance
qid	QueueId
pid	PolicerId
statmode	PolicerStatMode
aod...ucp	same as above

Accounting Files

When a policy has been created and applied to a service or network port, the accounting file is stored on the compact flash in a compressed XML file format. The router creates two directories on the compact flash to store the files. The following output displays a directory named **act-collect** that holds accounting files that are open and actively collecting statistics. The directory named **act** stores the files that have been closed and are awaiting retrieval.

```
ALA-1>file cf1:\# dir act*
12/19/2006 06:08a      <DIR>          act-collect
12/19/2006 06:08a      <DIR>          act

ALA-1>file cf1:\act-collect\ # dir
Directory of cf1:\act-collect#

12/23/2006 01:46a      <DIR>          .
12/23/2006 12:47a      <DIR>          ..
12/23/2006 01:46a      112 act1111-20031223-014658.xml.gz
12/23/2006 01:38a      197 act1212-20031223-013800.xml.gz
```

Accounting files always have the prefix **act** followed by the accounting policy ID, log ID and timestamp. The accounting log file naming and log file destination properties like rollover and retention are discussed in more detail in [Log Files on page 335](#).

Design Considerations

The router has ample resources to support large scale accounting policy deployments. When preparing for an accounting policy deployment, verify that data collection, file rollover, and file retention intervals are properly tuned for the amount of statistics to be collected.

If the accounting policy collection interval is too brief there may be insufficient time to store the data from all the services within the specified interval. If that is the case, some records may be lost or incomplete. Interval time, record types, and number of services using an accounting policy are all factors that should be considered when implementing accounting policies.

The rollover and retention intervals on the log files and the frequency of file retrieval must also be considered when designing accounting policy deployments. The amount of data stored depends on the type of record collected, the number of services that are collecting statistics, and the collection interval that is used. For example, with a 1GB CF and using the default collection interval, the system is expected to hold 48 hours worth of billing information.

Reporting and Time-Based Accounting

Node support for volume and time-based accounting concept provides an extra level of intelligence at the network element level in order to provide service models such as “prepaid access” in a scalable manner. This means that the network element gathers and stores per-subscriber accounting information and compare it with “pre-defined” quotas. Once a quota is exceeded, the pre-defined action (such as re-direction to a web portal or disconnect) is applied.

Overhead Reduction in Accounting: Custom Record

User Configurable Records

Users can define a collection of fields that make up a record. These records can be assigned to an accounting policy. These are user-defined records rather than being limited to pre-defined record types. The operator can select what queues and the counters within these queues that need to be collected. Refer to the predefined records containing a given field for XML field name of a custom record field.

Changed Statistics Only

A record is only generated if a significant change has occurred to the fields being written in a given the record. This capability applies to both ingress and egress records regardless on the method of delivery (such as RADIUS and XML). The capability also applies to Application Assurance records; however without an ability to specify different significant change values and per-field scope (for example, all fields of a custom record are collected if any activity was reported against any of the statistics that are part of the custom record).

Configurable Accounting Records

- [XML Accounting Files for Service and ESM-Based Accounting on page 368](#)
 - [RADIUS Accounting in Networks Using ESM on page 368](#)
-

XML Accounting Files for Service and ESM-Based Accounting

The `custom-record` command in the `config>log>accounting-policy` context provide the flexibility to reduce the volume of data generated, network operators can define the record that needs to be collected. This can eliminate queues or selected counters within these queues that are not relevant for billing.

Record headers including information such as service-ID, SAP-ID, etc., will always be generated.

RADIUS Accounting in Networks Using ESM

The `custom-record` command in the `config>subscr-mgmt>radius-accounting-policy` context provide the flexibility to include individual counters in RADIUS accounting messages. See the CLI tree for commands and syntax.

Significant Change Only Reporting

Another way to decrease accounting messaging related to overhead is to include only “active” objects in a periodical reporting. An “active object” in this context is an object which has seen a “significant” change in corresponding counters. A significant change is defined in terms of a cumulative value (the sum of all reference counters).

This concept is applicable to all methods used for gathering accounting information, such as an XML file and RADIUS, as well as to all applications using accounting, such as service-acct, ESM-acct, and Application Assurance.

Accounting records are reported at the periodical intervals. This periodic reporting is extended with an internal filter which omits periodical updates for objects whose counter change experienced lower changes than a defined (configurable) threshold.

Specific to RADIUS accounting the `significant-change` command does not affect ACCT-STOP messages. ACCT-STOP messages will be always sent, regardless the amount of change of the corresponding host.

For Application Assurance records, a significant change of 1 in any field of a customized record (send a record if any field changed) is supported. When configured, if any statistic field records activity, an accounting record containing all fields will be collected.

Immediate Completion of Records

Record Completion for XML Accounting

For ESM RADIUS accounting, an accounting stop message is sent when :

- A subscriber/subscriber-host is deleted.
- An SLA profile instance (non-HSMDA) or subscriber instance (HSMDA) is changed.

A similar concept is also used for XML accounting. In case the accounted object is deleted or changed, the latest information will be written in the XML file with a “final” tag indication in the record header.

AA Accounting per Forwarding Class

This feature allows the operator to report on protocol/application/app-group volume usage per forwarding class by adding a bitmap information representing the observed FC in the XML accounting files.

Configuration Notes

This section describes logging configuration caveats.

- A file or filter cannot be deleted if it has been applied to a log.
- File IDs, syslog IDs, or SNMP trap groups must be configured before they can be applied to a log ID.
- A file ID can only be assigned to *either* one log ID *or* one accounting policy.
- Accounting policies must be configured in the **config>log** context before they can be applied to a service SAP or service interface, or applied to a network port.
- The **snmp-trap-id** must be the same as the **log-id**.

Configuring Logging with CLI

This section provides information to configure logging using the command line interface.

Topics in this section include:

- [Log Configuration Overview on page 374](#)
→ [Log Types on page 374](#)
- [Basic Event Log Configuration on page 375](#)
- [Common Configuration Tasks on page 376](#)
- [Log Management Tasks on page 394](#)

Log Configuration Overview

Configure logging parameters to save information in a log file or direct the messages to other devices. Logging does the following:

- Provides you with logging information for monitoring and troubleshooting.
 - Allows you to select the types of logging information to be recorded.
 - Allows you to assign a severity to the log messages.
 - Allows you to select the source and target of logging information.
-

Log Types

Logs can be configured in the following contexts:

- Log file — Log files can contain log event message streams or accounting/billing information. Log file IDs are used to direct events, alarms/traps and debug information to their respective targets.
- SNMP trap groups — SNMP trap groups contain an IP address and community names which identify targets to send traps following specified events.
- Syslog — Information can be sent to a syslog host that is capable of receiving selected syslog messages from a network element.
- Event control — Configures a particular event or all events associated with an application to be generated or suppressed.
- Event filters — An event filter defines whether to forward or drop an event or trap based on match criteria.
- Accounting policies — An accounting policy defines the accounting records that will be created. Accounting policies can be applied to one or more service access points (SAPs).
- Event logs — An event log defines the types of events to be delivered to its associated destination.
- Event throttling rate — Defines the rate of throttling events.

Basic Event Log Configuration

The most basic log configuration must have the following:

- Log ID or accounting policy ID
- A log source
- A log destination

The following displays a log configuration example.

```
A:ALA-12>config>log# info
#-----
echo "Log Configuration "
#-----
    event-control "bgp" 2001 generate critical
    file-id 1
        description "This is a test file-id."
        location cf1:
    exit
    file-id 2
        description "This is a test log."
        location cf1:
    exit
    snmp-trap-group 7
        trap-target 11.22.33.44 "snmpv2c" notify-community "public"
    exit
    log-id 2
        from main
        to file 2
    exit
-----
A:ALA-12>config>log#
```

Common Configuration Tasks

The following sections are basic system tasks that must be performed.

- [Configuring a File ID on page 378](#)
 - [Configuring an Event Log on page 376](#)
 - [Configuring an Accounting Policy on page 379](#)
 - [Configuring Event Control on page 380](#)
 - [Configuring a Log Filter on page 382](#)
 - [Configuring an SNMP Trap Group on page 383](#)
 - [Configuring a Syslog Target on page 391](#)
-

Configuring an Event Log

An event log file contains information used to direct events, alarms, traps, and debug information to their respective destinations. One or more event sources can be specified. File IDs, SNMP trap groups, or syslog IDs must be configured before they can be applied to an event log ID.

Use the following CLI syntax to configure a log file:

```
CLI Syntax: config>log
                log-id log-id
                description description-string
                filter filter-id
                from {[main] [security] [change] [debug-trace]}
                to console
                to file file-id
                to memory [size]
                to session
                to snmp [size]
                to syslog syslog-id}
                time-format {local|utc}
                no shutdown
```

The following displays a log file configuration example:

```
ALA-12>config>log>log-id# info
-----
...
  log-id 2
    description "This is a test log file."
    filter 1
    from main security
    to file 1
  exit
...
-----
ALA-12>config>log>log-id#
```

Configuring a File ID

To create a log file a file ID is defined, specifies the target CF drive, and the rollover and retention interval period for the file. The rollover interval is defined in minutes and determines how long a file will be used before it is closed and a new log file is created. The retention interval determines how long the file will be stored on the CF before it is deleted.

Use the following CLI syntax to configure a log file:

```
CLI Syntax: config>log
                file-id log-file-id
                  description description-string
                  location cflash-id [backup-cflash-id]
                  rollover minutes [retention hours]
```

The following displays a log file configuration example:

```
A:ALA-12>config>log# info
-----
    file-id 1
      description "This is a log file."
      location cf1:
      rollover 600 retention 24
    exit
-----
A:ALA-12>config>log#
```

Configuring an Accounting Policy

Before an accounting policy can be created a target log file must be created to collect the accounting records. The files are stored in system memory of compact flash (cf1: or cf2:) in a compressed (tar) XML format and can be retrieved using FTP or SCP. See [Configuring an Event Log on page 376](#) and [Configuring a File ID on page 378](#).

Accounting policies must be configured in the **config>log** context before they can be applied to a service SAP or service interface, or applied to a network port.

The default accounting policy statement cannot be applied to LDP nor RSVP statistics collection records.

An accounting policy must define a record type and collection interval. Only one record type can be configured per accounting policy.

When creating accounting policies, one service accounting policy and one network accounting policy can be defined as default. If statistics collection is enabled on a SAP or network port and no accounting policy is applied, then the respective default policy is used. If no default policy is defined, then no statistics are collected unless a specifically defined accounting policy is applied.

Use the following CLI syntax to configure an accounting policy:

```
CLI Syntax: config>log
                accounting-policy acct-policy-id interval minutes
                description description-string
                default
                record record-name
                to file log-file-id
                no shutdown
```

The following displays a accounting policy configuration example:

```
A:ALA-12>config>log# info
-----
accounting-policy 4
  description "This is the default accounting policy."
  record complete-service-ingress-egress
  default
  to file 1
exit
accounting-policy 5
  description "This is a test accounting policy."
  record service-ingress-packets
  to file 3
exit
-----
A:ALA-12>config>log#
```

Configuring Event Control

Use the following CLI syntax to configure event control. Note that the **throttle** parameter used in the **event-control** command syntax enables throttling for a specific event type. The **config>log>throttle-rate** command configures the number of events and interval length to be applied to all event types that have throttling enabled by this **event-control** command.

CLI Syntax:

```
config>log
    event-control application-id [event-name|event-number] generate
        [severity-level] [throttle]
    event-control application-id [event-name|event-number] suppress
    throttle-rate events [interval seconds]
```

The following displays an event control configuration:

```
A:ALA-12>config>log# info
#-----
echo "Log Configuration"
#-----
    throttle-rate 500 interval 10
    event-control "oam" 2001 generate throttle
    event-control "ospf" 2001 suppress
    event-control "ospf" 2003 generate cleared
    event-control "ospf" 2014 generate critical
..
#-----
A:ALA-12>config>log>filter#
```

Configuring Throttle Rate

This command configures the number of events and interval length to be applied to all event types that have throttling enabled by the **event-control** command.

Use the following CLI syntax to configure the throttle rate.

CLI Syntax: `config>log#
throttle-rate events [interval seconds]`

The following displays a throttle rate configuration example:

```
*A:gal171>config>log# info
-----
      throttle-rate 500 interval 10
      event-control "bgp" 2001 generate throttle
-----
*A:gal171>config>log#
```

Configuring a Log Filter

Use the following CLI syntax to configure a log filter:

```
CLI Syntax: config>log
                filter filter-id
                  default-action {drop|forward}
                  description description-string
                  entry entry-id
                    action {drop|forward}
                    description description-string
                    match
                      application {eq|neq} application-id
                      number {eq|neq|lt|lte|gt|gte} event-id
                      router {eq|neq} router-instance [regex]
                      severity {eq|neq|lt|lte|gt|gte} severity-level
                      subject {eq|neq} subject [regex]
```

The following displays a log filter configuration example:

```
A:ALA-12>config>log# info
#-----
echo "Log Configuration "
#-----
    file-id 1
      description "This is our log file."
      location cf1:
      rollover 600 retention 24
    exit
    filter 1
      default-action drop
      description "This is a sample filter."
      entry 1
        action forward
        match
          application eq "mirror"
          severity eq critical
        exit
      exit
    exit
...
    log-id 2
      shutdown
      description "This is a test log file."
      filter 1
      from main security
      to file 1
    exit
...
#-----
A:ALA-12>config>log#
```

Configuring an SNMP Trap Group

The associated *log-id* does not have to be configured before a **snmp-trap-group** can be created, however, the **snmp-trap-group** must exist before the *log-id* can be configured to use it.

Use the following CLI syntax to configure an SNMP trap group:

```
CLI Syntax: config>log
                snmp-trap-group log-id
                    trap-target name [address ip-address] [port port]
                        [snmpv1|snmpv2c| snmpv3] notify-community communi-
                        tyName |snmpv3SecurityName [security-level {no-
                        auth-no-privacy|auth-no-privacy|privacy}] [replay]
```

The following displays a basic SNMP trap group configuration example:

```
A:ALA-12>config>log# info
-----
...
    snmp-trap-group 2
        trap-target 10.10.10.104:5 "snmpv3" notify-community "coummunitystring"
        exit
...
    log-id 2
        description "This is a test log file."
        filter 1
        from main security
        to file 1
    exit
...
-----
A:ALA-12>config>log#
```

The following displays a SNMP trap group, log, and interface configuration examples:

```
A:SetupCLI>config>log# snmp-trap-group 44
A:SetupCLI>config>log>snmp-trap-group# info
-----
      trap-target "xyz-test" address xx.xx.x.x snmpv2c notify-community "xyztesting"
      trap-target "test2" address xx.xx.xx.x snmpv2c notify-community "xyztesting"
-----
*A:SetupCLI>config>log>log-id# info
-----
      from main
      to snmp
-----
*A:SetupCLI>config>router# interface xyz-test
*A:SetupCLI>config>router>if# info
-----
      address xx.xx.xx.x/24
      port 1/1/1
-----
*A:SetupCLI>config>router>if#
```

Setting the Replay Parameter

For this example the replay parameter was set by a SNMP SET request for the trap-target address 10.10.10.3 which is bound to port-id 1/1/1.

```
A:SetupCLI>config>log>snmp-trap-group 44
A:SetupCLI>config>log>snmp-trap-group# info
-----
      trap-target "xyz-test" address 10.10.10.3 snmpv2c notify-community "xyztesting"
replay
      trap-target "test2" address 20.20.20.5 snmpv2c notify-community "xyztesting"
-----
A:SetupCLI>config>log>snmp-trap-group#
```

In the following output, note that the **Replay** field changed from disabled to enabled.

```
A:SetupCLI>config>log>snmp-trap-group# show log snmp-trap-group 44
=====
SNMP Trap Group 44
=====
Description : none
-----
Name       : xyz-test
Address    : 10.10.10.3
Port      : 162
Version   : v2c
Community  : xyztesting
Sec. Level : none
Replay    : enabled
Replay from : n/a
Last replay : never
-----
Name       : test2
Address    : 20.20.20.5
Port      : 162
Version   : v2c
Community  : xyztesting
Sec. Level : none
Replay    : disabled
Replay from : n/a
Last replay : never
=====
A:SetupCLI>config>log>snmp-trap-group#
```

Since no events are waiting to be replayed, the log displays as before.

```
A:SetupCLI>config>log>snmp-trap-group# show log log-id 44
=====
Event Log 44
=====
SNMP Log contents [size=100  next event=3819  (wrapped)]

3818 2008/04/22 23:35:39.89 UTC WARNING: SYSTEM #2009 Base IP
"Status of vRtrIfTable: router Base (index 1) interface xyz-test (index 35) changed
administrative state: inService, operational state: inService"

3817 2008/04/22 23:35:39.89 UTC WARNING: SNMP #2005 Base xyz-test
"Interface xyz-test is operational"

3816 2008/04/22 23:35:39.89 UTC WARNING: SNMP #2005 Base 1/1/1
"Interface 1/1/1 is operational"

3815 2008/04/22 23:35:39.71 UTC WARNING: SYSTEM #2009 Base CHASSIS
"Status of Mda 1/1 changed administrative state: inService, operational state: inService"

3814 2008/04/22 23:35:38.88 UTC MINOR: CHASSIS #2002 Base Mda 1/2
"Class MDA Module : inserted"

3813 2008/04/22 23:35:38.88 UTC MINOR: CHASSIS #2002 Base Mda 1/1
```

Shutdown In-Band Port

A **shutdown** on the in-band port that the trap-target address is bound to causes the route to that particular trap target to be removed from the route table. When the SNMP module is notified of this event, it marks the trap-target as inaccessible and saves the sequence-id of the first SNMP notification that will be missed by the trap-target.

Example:

```
config>log>snmp-trap-group# exit all
#configure port 1/1/1 shutdown
#
# tools perform log test-event
#
```

The **Replay from** field is updated with the sequence-id of the first event that will be replayed when the trap-target address is added back to the route table.

```
*A:SetupCLI# show log snmp-trap-group 44
=====
SNMP Trap Group 44
=====
Description : none
-----
Name       : xyz-test
Address    : 10.10.10.3
Port      : 162
Version    : v2c
Community  : xyztesting
Sec. Level : none
Replay     : enabled
Replay from : event #3819
Last replay : never
-----
Name       : test2
Address    : 20.20.20.5
Port      : 162
Version    : v2c
Community  : xyztesting
Sec. Level : none
Replay     : disabled
Replay from : n/a
Last replay : never
=====
*A:SetupCLI#
```

Common Configuration Tasks

A display of the event log indicates which trap targets are not accessible and waiting for notification replay and the sequence ID of the first notification that will be replayed. Note that if there are more missed events than the log size, the replay will actually start from the first available missed event.

```
*A:SetupCLI# show log log-id 44
=====
Event Log 44
=====
SNMP Log contents [size=100  next event=3821  (wrapped)]
Cannot send to SNMP target address 10.10.10.3.
Waiting to replay starting from event #3819

3820 2008/04/22 23:41:28.00 UTC INDETERMINATE: LOGGER #2011 Base Event Test
"Test event has been generated with system object identifier tmnxModelSR12Reg.
System description: TiMOS-B-0.0.private both/i386 ALCATEL SR 7750 Copyright (c) 2000-2008
Alcatel-Lucent.
All rights reserved. All use subject to applicable license agreements.
Built on Tue Apr 22 14:41:18 PDT 2008 by test123 in /test123/ws/panos/main"

3819 2008/04/22 23:41:20.37 UTC WARNING: MC_REDUNDANCY #2022 Base operational state of
peer chan*
"The MC-Ring operational state of peer 2.2.2.2 changed to outOfService."

3818 2008/04/22 23:35:39.89 UTC WARNING: SYSTEM #2009 Base IP
"Status of vRtrIfTable: router Base (index 1) interface xyz-test (index 35) changed
administrative state: inService, operational state: inService"

3823 2008/04/22 23:41:49.82 UTC WARNING: SNMP #2005 Base xyz-test
"Interface xyz-test is operational"
```

No Shutdown Port

A **no shutdown** command executed on the in-band port to which the trap-target address is bound will cause the route to that trap target to be re-added to the route table. When the SNMP trap module is notified of this event, it resends the notifications that were missed while there was no route to the trap-target address.

```
Example:    configure# port 1/1/1 no shutdown
              #
              # tools perform log test-event
```

After the notifications have been replayed the **Replay from** field indicates n/a because there are no more notifications waiting to be replayed and the **Last replay** field timestamp has been updated.

```
*A:SetupCLI# show log snmp-trap-group 44
=====
SNMP Trap Group 44
=====
Description : none
-----
Name       : xyz-test
Address    : 10.10.10.3
Port       : 162
Version    : v2c
Community  : xyztesting
Sec. Level : none
Replay     : enabled
Replay from : n/a
Last replay : 04/22/2008 18:52:36
-----
Name       : test2
Address    : 20.20.20.5
Port       : 162
Version    : v2c
Community  : xyztesting
Sec. Level : none
Replay     : disabled
Replay from : n/a
Last replay : never
=====
*A:SetupCLI#
```

A display of the event log shows that it is no longer waiting to replay notifications to one or more of its trap target addresses. An event message has been written to the logger that indicates the replay to the trap-target address has happened and displays the notification sequence ID of the first and last replayed notifications.

```
*A:SetupCLI# show log log-id 44
=====
```

Common Configuration Tasks

Event Log 44

=====

SNMP Log contents [size=100 next event=3827 (wrapped)]

3826 2008/04/22 23:42:02.15 UTC MAJOR: LOGGER #2015 Base Log-id 44

"Missed events 3819 to 3825 from Log-id 44 have been resent to SNMP notification target address 10.10.10.3."

3825 2008/04/22 23:42:02.15 UTC INDETERMINATE: LOGGER #2011 Base Event Test

"Test event has been generated with system object identifier tmnxModelSR12Reg.

System description: TiMOS-B-0.0.private both/i386 ALCATEL SR 7750 Copyright (c) 2000-2008 Alcatel-Lucent.

All rights reserved. All use subject to applicable license agreements.

Built on Tue Apr 22 14:41:18 PDT 2008 by test123 in /test123/ws/panos/main"

3824 2008/04/22 23:41:49.82 UTC WARNING: SYSTEM #2009 Base IP

"Status of vRtrIfTable: router Base (index 1) interface xyz-test (index 35) changed administrative s
tate: inService, operational state: inService"

3823 2008/04/22 23:41:49.82 UTC WARNING: SNMP #2005 Base xyz-test

"Interface xyz-test is operational"

Configuring a Syslog Target

Log events cannot be sent to a syslog target host until a valid syslog ID exists.

Use the following CLI syntax to configure a syslog file:

```
CLI Syntax: config>log
                syslog syslog-id
                   description description-string
                   address ip-address
                   log-prefix log-prefix-string
                   port port
                   level {emergency|alert|critical|error|warning|notice|in-
                       fo|debug}
                   facility syslog-facility
```

The following displays a syslog configuration example:

```
A:ALA-12>config>log# info
-----
...
    syslog 1
      description "This is a syslog file."
      address 10.10.10.104
      facility user
      level warning
    exit
...
-----
A:ALA-12>config>log#
```

Configuring an Accounting Custom Record

```
A:ALA-48>config>subscr-mgmt>acct-plcy# info
-----
..
    custom-record
    queue 1
    i-counters
        high-octets-discarded-count
        low-octets-discarded-count
        in-profile-octets-forwarded-count
        out-profile-octets-forwarded-count
    exit
    e-counters
        in-profile-octets-forwarded-count
        in-profile-octets-discarded-count
        out-profile-octets-forwarded-count
        out-profile-octets-discarded-count
    exit
    exit
    significant-change 20
    ref-queue all
    i-counters
        in-profile-packets-forwarded-count
        out-profile-packets-forwarded-count
    exit
    e-counters
        in-profile-packets-forwarded-count
        out-profile-packets-forwarded-count
    exit
    exit
..
-----
A:ALA-48>config>subscr-mgmt>acct-plcy#
```

The following is an example custom record configuration.

```
Dut-C>config>log>acct-policy>cr# info
-----
    aa-specific
    aa-sub-counters
        short-duration-flow-count
        medium-duration-flow-count
        long-duration-flow-count
        total-flow-duration
        total-flows-completed-count
    exit
    from-aa-sub-counters
        flows-admitted-count
        flows-denied-count
        flows-active-count
        packets-admitted-count
        octets-admitted-count
        packets-denied-count
        octets-denied-count
        max-throughput-octet-count
```



```
max-throughput-packet-count
max-throughput-timestamp
forwarding-class
exit
to-aa-sub-counters
flows-admitted-count
flows-denied-count
flows-active-count
packets-admitted-count
octets-admitted-count
packets-denied-count
octets-denied-count
max-throughput-octet-count
max-throughput-packet-count
max-throughput-timestamp
forwarding-class
exit
exit
significant-change 1
ref-aa-specific-counter any
-----
```

Log Management Tasks

This section discusses the following logging tasks:

- [Modifying a Log File on page 395](#)
- [Deleting a Log File on page 397](#)
- [Modifying a File ID on page 398](#)
- [Deleting a File ID on page 399](#)
- [Modifying a Syslog ID on page 400](#)
- [Deleting a Syslog on page 401](#)
- [Modifying an SNMP Trap Group on page 402](#)
- [Deleting an SNMP Trap Group on page 403](#)
- [Modifying a Log Filter on page 404](#)
- [Deleting a Log Filter on page 406](#)
- [Modifying Event Control Parameters on page 407](#)
- [Returning to the Default Event Control Configuration on page 408](#)

Modifying a Log File

Use the following CLI syntax to modify a log file:

CLI Syntax: config>log
 log-id log-id
 description description-string
 filter filter-id
 from {[main] [security] [change] [debug-trace]}
 to console
 to file file-id
 to memory [size]
 to session
 to snmp [size]
 to syslog syslog-id}

The following displays the current log configuration:

```
ALA-12>config>log>log-id# info
-----
...
  log-id 2
    description "This is a test log file."
    filter 1
    from main security
    to file 1
  exit
...
-----
ALA-12>config>log>log-id#
```

The following displays an example to modify log file parameters:

Example: config# log
 config>log# log-id 2
 config>log>log-id# description "Chassis log file."
 config>log>log-id# filter 2
 config>log>log-id# from security
 config>log>log-id# exit

Log Management Tasks

The following displays the modified log file configuration:

```
A:ALA-12>config>log# info
-----
...
  log-id 2
      description "Chassis log file."
      filter 2
      from security
      to file 1
  exit
...
-----
A:ALA-12>config>log#
```

Deleting a Log File

The log ID must be shutdown first before it can be deleted. In a previous example, **file 1** is associated with **log-id 2**.

```
A:ALA-12>config>log# info
-----
file-id 1
  description "LocationTest."
  location cfl:
  rollover 600 retention 24
  exit
...
log-id 2
  description "Chassis log file."
  filter 2
  from security
  to file 1
  exit
...
-----
A:ALA-12>config>log#
```

Use the following CLI syntax to delete a log file:

CLI Syntax:

```
config>log
  no log-id log-id
  shutdown
```

The following displays an example to delete a log file:

Example:

```
config# log
config>log# log-id 2
config>log>log-id# shutdown
config>log>log-id# exit
config>log# no log-id 2
```

Modifying a File ID

NOTE: When the **file-id** location parameter is modified, log files are not written to the new location until a rollover occurs or the log is manually cleared. A rollover can be forced by using the **clear>log** command. Subsequent log entries are then written to the new location. If a rollover does not occur or the log not cleared, the old location remains in effect.

Use the following CLI syntax to modify a log file:

CLI Syntax:

```
config>log
    file-id log-file-id
        description description-string
        location [cflash-id] [backup-cflash-id]
        rollover minutes [retention hours]
```

The following displays the current log configuration:

```
A:ALA-12>config>log# info
-----
    file-id 1
        description "This is a log file."
        location cf1:
        rollover 600 retention 24
    exit
-----
A:ALA-12>config>log#
```

The following displays an example to modify log file parameters:

Example:

```
config# log
config>log# file-id 1
config>log>file-id# description "LocationTest."
config>log>file-id# location cf2:
config>log>file-id# rollover 2880 retention 500
config>log>file-id# exit
```

The following displays the file modifications:

```
A:ALA-12>config>log# info
-----
...
    file-id 1
        description "LocationTest."
        location cf2:
        rollover 2880 retention 500
    exit
...
-----
A:ALA-12>config>log#
```

Deleting a File ID

NOTE: All references to the file ID must be deleted before the file ID can be removed.

Use the following CLI syntax to delete a log ID:

CLI Syntax: `config>log`
`no file-id log-file-id`

The following displays an example to delete a file ID:

Example: `config>log# no file-id 1`

Modifying a Syslog ID

NOTE: All references to the syslog ID must be deleted before the syslog ID can be removed.

Use the following CLI syntax to modify a syslog ID parameters:

CLI Syntax:

```
config>log
  syslog syslog-id
    description description-string
    address ip-address
    log-prefix log-prefix-string
    port port
    level {emergency|alert|critical|error|warning|notice|info|debug}
    facility syslog-facility
```

The following displays an example of the syslog ID modifications:

Example:

```
config# log
config>log# syslog 1
config>log>syslog$ description "Test syslog."
config>log>syslog# address 10.10.0.91
config>log>syslog# facility mail
config>log>syslog# level info
```

The following displays the syslog configuration:

```
A:ALA-12>config>log# info
-----
...
    syslog 1
      description "Test syslog."
      address 10.10.10.91
      facility mail
      level info
    exit
...
-----
A:ALA-12>config>log#
```

Deleting a Syslog

Use the following CLI syntax to delete a syslog file:

CLI Syntax: `config>log`
`no syslog syslog-id`

The following displays an example to delete a syslog ID:

Example: `config# log`
`config>log# no syslog 1`

Modifying an SNMP Trap Group

Use the following CLI syntax to modify an SNMP trap group:

CLI Syntax: config>log
 snmp-trap-group log-id
 trap-target name [address ip-address] [port port]
 [snmpv1|snmpv2c| snmpv3] notify-community communi-
 tyName |snmpv3SecurityName [security-level {no-
 auth-no-privacy|auth-no-privacy|privacy}]

The following displays the current SNMP trap group configuration:

```
A:ALA-12>config>log# info
-----
...
    snmp-trap-group 10
        trap-target 10.10.10.104:5 "snmpv3" notify-community "coummunitystring"
        exit
...
-----
A:ALA-12>config>log#
```

The following displays an example of the command usage to modify an SNMP trap group:

Example: config# log
 config>log# snmp-trap-group 10
 config>log>snmp-trap-group# no trap-target 10.10.10.104:5
 config>log>snmp-trap-group# snmp-trap-group# trap-target
 10.10.0.91:1 snmpv2c notify-community "com1"

The following displays the SNMP trap group configuration:

```
A:ALA-12>config>log# info
-----
...
    snmp-trap-group 10
        trap-target 10.10.0.91:1 "snmpv2c" notify-community "com1"
        exit
...
-----
A:ALA-12>config>log#
```

Deleting an SNMP Trap Group

Use the following CLI syntax to delete a trap target and SNMP trap group:

CLI Syntax: `config>log`
`no snmp-trap-group log-id`
`no trap-target name`

The following displays the SNMP trap group configuration:

```
A:ALA-12>config>log# info
-----
...
    snmp-trap-group 10
        trap-target 10.10.0.91:1 "snmpv2c" notify-community "com1"
    exit
...
-----
A:ALA-12>config>log#
```

The following displays an example to delete a trap target and an SNMP trap group.

Example: `config>log# snmp-trap-group 10`
`config>log>snmp-trap-group# no trap-target 10.10.0.91:1`
`config>log>snmp-trap-group# exit`
`config>log# no snmp-trap-group 10`

Modifying a Log Filter

Use the following CLI syntax to modify a log filter:

```
CLI Syntax: config>log
                filter filter-id
                  default-action {drop|forward}
                  description description-string
                  entry entry-id
                    action {drop|forward}
                    description description-string
                    match
                      application {eq|neq} application-id
                      number {eq|neq|lt|lte|gt|gte} event-id
                      router {eq|neq} router-instance [regex]
                      severity {eq|neq|lt|lte|gt|gte} severity-level
                      subject {eq|neq} subject [regex]
```

The following output displays the current log filter configuration:

```
ALA-12>config>log# info
#-----
echo "Log Configuration "
#-----
...
    filter 1
      default-action drop
      description "This is a sample filter."
      entry 1
        action forward
        match
          application eq "mirror"
          severity eq critical
        exit
      exit
    exit
  ...
#-----
ALA-12>config>log#
```

The following displays an example of the log filter modifications:

```
Example: config# log
config>log# filter 1
config>log>filter# description "This allows <n>."
config>log>filter# default-action forward
config>log>filter# entry 1
config>log>filter>entry$ action drop
config>log>filter>entry# match
config>log>filter>entry>match# application eq user
```

```
config>log>filter>entry>match# number eq 2001
config>log>filter>entry>match# no severity
config>log>filter>entry>match# exit
```

The following displays the log filter configuration:

```
A:ALA-12>config>log>filter# info
-----
...
    filter 1
      description "This allows <n>."
      entry 1
        action drop
        match
          application eq "user"
          number eq 2001
        exit
      exit
    exit
...
-----
A:ALA-12>config>log>filter#
```

Deleting a Log Filter

Use the following CLI syntax to delete a log filter:

CLI Syntax: `config>log
no filter filter-id`

The following output displays the current log filter configuration:

```
A:ALA-12>config>log>filter# info
-----
...
    filter 1
      description "This allows <n>."
      entry 1
        action drop
        match
          application eq "user"
          number eq 2001
        exit
      exit
    exit
  ...
-----
A:ALA-12>config>log>filter#
```

The following displays an example of the command usage to delete a log filter:

Example: `config>log# no filter 1`

Modifying Event Control Parameters

Use the following CLI syntax to modify event control parameters:

CLI Syntax: config>log
 event-control application-id [event-name|event-number] generate[severity-level] [throttle]
 event-control application-id [event-name|event-number] suppress

The following displays the current event control configuration:

```
A:ALA-12>config>log# info
-----
...
    event-control "bgp" 2014 generate critical
...
-----
A:ALA-12>config>log#
```

The following displays an example of an event control modifications:

Example: config# log
 config>log# event-control bgp 2014 suppress

The following displays the log filter configuration:

```
A:ALA-12>config>log# info
-----
...
    event-control "bgp" 2014 suppress
...
-----
A:ALA-12>config>log#
```

Returning to the Default Event Control Configuration

The **no** form of the **event-control** command returns modified values back to the default values.

Use the following CLI syntax to modify event control parameters:

CLI Syntax: `config>log`
`no event-control application [event-name |event-number]`

The following displays an example of the command usage to return to the default values:

Example: `config# log`
`config>log# no event-control "bgp" 2001`
`config>log# no event-control "bgp" 2002`
`config>log# no event-control "bgp" 2014`

```
A:ALA-12>config>log# info detail
-----
#-----
echo "Log Configuration"
#-----
event-control "bgp" 2001 generate minor
event-control "bgp" 2002 generate warning
event-control "bgp" 2003 generate warning
event-control "bgp" 2004 generate critical
event-control "bgp" 2005 generate warning
event-control "bgp" 2006 generate warning
event-control "bgp" 2007 generate warning
event-control "bgp" 2008 generate warning
event-control "bgp" 2009 generate warning
event-control "bgp" 2010 generate warning
event-control "bgp" 2011 generate warning
event-control "bgp" 2012 generate warning
event-control "bgp" 2013 generate warning
event-control "bgp" 2014 generate warning
event-control "bgp" 2015 generate critical
event-control "bgp" 2016 generate warning
...
-----
A:ALA-12>config>log#
```

Log Command Reference

Command Hierarchies

- [Log Command Reference on page 409](#)
 - [Accounting Policy Commands on page 410](#)
 - [Custom Record Commands on page 411](#)
 - [File ID Commands on page 414](#)
 - [Event Filter Commands on page 414](#)
 - [Log ID Commands on page 415](#)
 - [SNMP Trap Group Commands on page 415](#)
 - [Syslog Commands on page 416](#)
- [Show Commands on page 417](#)
- [Clear Command on page 417](#)

Log Configuration Commands

```

config
  — log
    — app-route-notifications
      — [no] cold-start-wait
      — [no] route-recovery-wait
    — event-control application-id [event-name | event-number] [generate [severity-level] [throt-
tle] [specific-throttle-rate events-limit interval seconds | disable-specific-throttle]
    — event-control application-id [event-name | event-number] suppress
    — no event-control application [event-name | event-number]
    — [no] event-damping
    — route-preference primary {inband | outband} secondary {inband | outband | none}
    — no route-preference
    — throttle-rate events [interval seconds]
    — no throttle-rate

```

Accounting Policy Commands

```
config
  — log
    — collection-interval minutes
    — no collection-interval
    — accounting-policy acct-policy-id
    — no accounting-policy acct-policy-id
      — [no] auto-bandwidth
      — [no] default
      — description description-string
      — no description
      — [no] include-router-info
      — [no] include-system-info
      — record record-name
      — no record
      — [no] shutdown
      — to file log-file-id
```

Custom Record Commands

```

config
  — log
    — accounting-policy acct-policy-id [interval minutes]
    — no accounting-policy acct-policy-id
      — collection-interval minutes
      — no collection-interval
      — [no] custom-record
        — [no] aa-specific
          — aa-sub-counters [all]
          — no aa-sub-counters
            — [no] long-duration-flow-count
            — [no] medium-duration-flow-count
            — [no] short-duration-flow-count
            — [no] total-flow-duration
            — [no] total-flows-completed-count
          — from-aa-sub-counters [all]
          — no from-aa-sub-counters
            — all
            — [no] flows-active-count [all]
            — [no] flows-admitted-count
            — [no] flows-denied-count
            — [no] forwarding-class
            — [no] max-throughput-octet-count
            — [no] max-throughput-packet-count
            — [no] max-throughput-packet-count
            — [no] octets-admitted-count
            — [no] octets-denied-count
            — [no] packets-admitted-count
            — [no] packets-denied-count
          — to-aa-sub-counters [all]
          — to-aa-sub-counters
            — all
            — [no] flows-active-count [all]
            — [no] flows-admitted-count
            — [no] flows-denied-count
            — [no] forwarding-class
            — [no] max-throughput-octet-count
            — [no] max-throughput-packet-count
            — [no] max-throughput-packet-count
            — [no] octets-admitted-count
            — [no] octets-denied-count
            — [no] packets-admitted-count
            — [no] packets-denied-count
        — [no] override-counter override-counter-id
          — e-counters [all]
          — no e-counters
            — [no] in-profile-octets-discarded-count
            — [no] in-profile-octets-forwarded-count
            — [no] in-profile-packets-discarded-count
            — [no] in-profile-packets-forwarded-count
            — [no] out-profile-octets-discarded-count
            — [no] out-profile-octets-forwarded-count

```

- [no] **out-profile-packets-discarded-count**
- [no] **out-profile-packets-forwarded-count**
- **i-counters** [all]
- **no i-counters**
 - [no] **in-profile-octets-discarded-count**
 - [no] **in-profile-octets-forwarded-count**
 - [no] **in-profile-packets-discarded-count**
 - [no] **in-profile-packets-forwarded-count**
 - [no] **out-profile-octets-discarded-count**
 - [no] **out-profile-octets-forwarded-count**
 - [no] **out-profile-packets-discarded-count**
 - [no] **out-profile-packets-forwarded-count**
- [no] **queue** *queue-id*
 - **e-counters** [all]
 - **no e-counters**
 - [no] **in-profile-octets-discarded-count**
 - [no] **in-profile-octets-forwarded-count**
 - [no] **in-profile-packets-discarded-count**
 - [no] **in-profile-packets-forwarded-count**
 - [no] **out-profile-octets-discarded-count**
 - [no] **out-profile-octets-forwarded-count**
 - [no] **out-profile-packets-discarded-count**
 - [no] **out-profile-packets-forwarded-count**
 - **i-counters** [all]
 - **no i-counters**
 - [no] **all-octets-offered-count**
 - [no] **all-packets-offered-count**
 - [no] **high-octets-discarded-count**
 - [no] **high-octets-offered-count**
 - [no] **high-packets-discarded-count**
 - [no] **high-packets-offered-count**
 - [no] **in-profile-octets-forwarded-count**
 - [no] **in-profile-packets-forwarded-count**
 - [no] **low-octets-discarded-count**
 - [no] **low-packets-discarded-count**
 - [no] **low-octets-offered-count**
 - [no] **low-packets-offered-count**
 - [no] **out-profile-octets-forwarded-count**
 - [no] **out-profile-packets-forwarded-count**
 - [no] **uncoloured-octets-offered-count**
 - [no] **uncoloured-packets-offered-count**
- **ref-aa-specific-counter** any
- **no ref-aa-specific-counter**
- **ref-override-counter** *ref-override-counter-id*
- **ref-override-counter** all
- **no ref-override-counter**
 - **e-counters** [all]
 - **no e-counters**
 - [no] **in-profile-octets-discarded-count**
 - [no] **in-profile-octets-forwarded-count**
 - [no] **in-profile-packets-discarded-count**
 - [no] **in-profile-packets-forwarded-count**
 - [no] **out-profile-octets-discarded-count**
 - [no] **out-profile-octets-forwarded-count**
 - [no] **out-profile-packets-discarded-count**

- [no] **out-profile-packets-forwarded-count**
- **i-counters** [all]
- **no i-counters**
 - [no] **all-octets-offered-count**
 - [no] **all-packets-offered-count**
 - [no] **high-octets-discarded-count**
 - [no] **high-octets-offered-count**
 - [no] **high-packets-discarded-count**
 - [no] **high-packets-offered-count**
 - [no] **in-profile-octets-forwarded-count**
 - [no] **in-profile-packets-forwarded-count**
 - [no] **low-octets-discarded-count**
 - [no] **low-packets-discarded-count**
 - [no] **low-octets-offered-count**
 - [no] **low-packets-offered-count**
 - [no] **out-profile-octets-forwarded-count**
 - [no] **out-profile-packets-forwarded-count**
 - [no] **uncoloured-octets-offered-count**
 - [no] **uncoloured-packets-offered-count**
- **ref-queue** *queue-id*
- **ref-queue** all
- **no ref-queue**
 - **e-counters** [all]
 - **no e-counters**
 - [no] **in-profile-octets-discarded-count**
 - [no] **in-profile-octets-forwarded-count**
 - [no] **in-profile-packets-discarded-count**
 - [no] **in-profile-packets-forwarded-count**
 - [no] **out-profile-octets-discarded-count**
 - [no] **out-profile-octets-forwarded-count**
 - [no] **out-profile-packets-discarded-count**
 - [no] **out-profile-packets-forwarded-count**
 - **i-counters** [all]
 - **no i-counters**
 - [no] **all-octets-offered-count**
 - [no] **all-packets-offered-count**
 - [no] **high-octets-discarded-count**
 - [no] **high-octets-offered-count**
 - [no] **high-packets-discarded-count**
 - [no] **high-packets-offered-count**
 - [no] **in-profile-octets-forwarded-count**
 - [no] **in-profile-packets-forwarded-count**
 - [no] **low-octets-discarded-count**
 - [no] **low-packets-discarded-count**
 - [no] **low-octets-offered-count**
 - [no] **low-packets-offered-count**
 - [no] **out-profile-octets-forwarded-count**
 - [no] **out-profile-packets-forwarded-count**
- **significant-change** *delta*
- **no significant-change**

File ID Commands

```

config
  — log
    — [no] file-id log-file-id
      — description description-string
      — no description
      — location cflash-id [backup-cflash-id]
      — rollover minutes [retention hours]
      — no rollover

```

Event Filter Commands

Refer to the 7x50 SR OS Services Guide for information about configuring filter logs in a VPRN service.

```

config
  — log
    — [no] filter filter-id
      — default-action {drop | forward}
      — no default-action
      — description description-string
      — no description
      — [no] entry entry-id
        — action {drop | forward}
        — no action
        — description description-string
        — no description
        — [no] match
          — application {eq | neq} application-id
          — no application
          — number {eq | neq | lt | lte | gt | gte} event-id
          — no number
          — router {eq | neq} router-instance [regexp]
          — no router
          — severity {eq | neq | lt | lte | gt | gte} severity-level
          — no severity
          — subject {eq | neq} subject [regexp]
          — no subject

```

Log ID Commands

Refer to the 7x50 SR OS Services Guide for information about configuring logs in a VPRN service.

```

config
  — log
    — [no] log-id log-id
      — description description-string
      — no description
      — filter filter-id
      — no filter
      — from {[main] [security] [change] [debug-trace]}
      — no from
      — [no] shutdown
      — time-format {local | utc}
      — to console
      — to file log-file-id
      — to memory [size]
      — to session
      — to snmp [size]
      — to syslog syslog-id

```

SNMP Trap Group Commands

Refer to the 7x50 SR OS Services Guide for information about configuring SNMP trap group logs in a VPRN service.

```

config
  — log
    — [no] snmp-trap-group log-id
      — description description-string
      — no description
      — trap-target name [address ip-address] [port port] [snmpv1 | snmpv2c | snmpv3]
      — notify-community communityName | snmpv3SecurityName [security-level {no-auth-no-privacy | auth-no-privacy | privacy}] [replay]
      — no trap-target name

```

Syslog Commands

Refer to the 7x50 SR OS Services Guide for information about configuring syslogs in a VPRN service.

```
config
  — log
    — [no] syslog syslog-id
      — address ip-address
      — no address
      — description description-string
      — no description
      — facility syslog-facility
      — no facility
      — level {emergency | alert | critical | error | warning | notice | info | debug}
      — no level
      — log-prefix log-prefix-string
      — no log-prefix
      — port port
      — no port
```

Show Commands

```

show
  — log
    — accounting-policy [acct-policy-id] [access | network]
    — accounting-records
    — applications
    — event-control [application [event-name | event-number]]
    — file-id [log-file-id]
    — filter-id [filter-id]
    — log-collector
    — log-id [log-id] [severity severity-level] [application application] [sequence from-seq [to-seq]] [count count] [router router-instance [expression] [subject subject [regexp]] [ascending|descending]
    — snmp-trap-group [log-id]
    — syslog [syslog-id]

show
  — service service-id
    — log
      — filter-id [filter-id]
      — log-id [log-id] [severity severity-level] [application application] [sequence from-seq [to-seq]] [count count] [subject subject [regexp]] [ascending|descending]
      — snmp-trap-group [log-id]
      — syslog [syslog-id]

```

Clear Command

```

clear
  — log log-id

```

Configuration Commands

Generic Commands

description

Syntax	description <i>string</i> no description
Context	config>log>filter config>log>filter>entry config>log>log-id config>log>accounting-policy config>log>file-id config>log>syslog config>log>snmp-trap-group
Description	This command creates a text description stored in the configuration file for a configuration context. The description command associates a text string with a configuration context to help identify the content in the configuration file. The no form of the command removes the string from the configuration.
Default	No text description is associated with this configuration. The string must be entered.
Parameters	<i>string</i> — The description can contain a string of up to 80 characters composed of printable, 7-bit ASCII characters. If the string contains special characters (#, \$, spaces, etc.), the entire string must be enclosed within double quotes.

shutdown

Syntax	[no] shutdown
Context	config>log>log-id config>log>accounting-policy
Description	This command administratively disables an entity. When disabled, an entity does not change, reset, or remove any configuration settings or statistics. The operational state of the entity is disabled as well as the operational state of any entities contained within. Many objects must be shut down before they may be deleted. The no form of this command administratively enables an entity.
Default	no shutdown
Special Cases	log-id <i>log-id</i> — When a <i>log-id</i> is shut down, no events are collected for the entity. This leads to the loss of event data.

accounting-policy *accounting Policy* — When an accounting policy is shut down, no accounting data is written to the destination log ID. Counters in the billing data reflect totals, not increments, so when the policy is re-enabled (**no shutdown**) the counters include the data collected during the period the policy was shut down.

app-route-notifications

Syntax	app-route-notifications
Context	config>log
Description	Specific system applications in SR OS can take action based on a route to certain IP destinations being available. This CLI branch contains configuration related to these route availability notifications. A delay can be configured between the time that a route is determined as available in the CPM, and the time that the application is notified of the available route. For example, this delay may be used to increase the chances that other system modules (such as IOMs/XCMs/MDAs/XMAs) are fully programmed with the new route before the application takes action. Currently, the only application that acts upon these <i>route available</i> or <i>route changed</i> notifications with their configurable delays is the SNMP replay feature, which receives notifications of route availability to the SNMP trap receiver destination IP address.

cold-start-wait

Syntax	[no] cold-start-wait
Context	config>log>app-route-notifications
Description	The time delay that must pass before notifying specific CPM applications that a route is available after a cold reboot.
Default	no cold-start-wait
Parameters	— Values seconds: 1 – 300 Default 0

route-recovery-wait

Syntax	[no] route-recovery-wait
Context	config>log>app-route-notifications
Description	The time delay that must pass before notifying specific CPM applications after the recovery or change of a route during normal operation.
Default	no route-recovery-wait

Parameters	— Values	seconds: 1 – 100
	Default	0

event-control

Syntax	<pre> event-control <i>application-id</i> [<i>event-name</i> <i>event-number</i>] [generate][<i>severity-level</i>] [throttle] [specific-throttle-rate <i>events-limit interval seconds</i> disable-specific-throttle] event-control <i>application-id</i> [<i>event-name</i> <i>event-number</i>] suppress no event-control <i>application</i> [<i>event-name</i> <i>event-number</i>] </pre>
Context	config>log
Description	<p>This command is used to specify that a particular event or all events associated with an application is either generated or suppressed.</p> <p>Events are generated by an application and contain an event number and description explaining the cause of the event. Each event has a default designation which directs it to be generated or suppressed.</p> <p>Events are generated with a default severity level that can be modified by using the <i>severity-level</i> option.</p> <p>Events that are suppressed by default are typically used for debugging purposes. Events are suppressed at the time the application requests the event's generation. No event log entry is generated regardless of the destination. While this feature can save processor resources, there may be a negative effect on the ability to troubleshoot problems if the logging entries are squelched. In reverse, indiscriminate application may cause excessive overhead.</p> <p>The rate of event generation can be throttled by using the throttle parameter.</p> <p>The no form of the command reverts the parameters to the default setting for events for the application or a specific event within the application. The severity, generate, suppress, and throttle options will also be reset to the initial values.</p>
Default	Each event has a set of default settings. To display a list of all events and the current configuration use the event-control command.
Parameters	<p><i>application-id</i> — The application whose events are affected by this event control filter.</p> <p>Default None, this parameter must be explicitly specified.</p> <p>Values A valid application name. To display a list of valid application names, use the applications command. Some examples of valid applications are:</p> <p>bgp, cflowd, chassis, debug, igmp, lldp, mirror, ospf, pim, port, snmp, system, user, vrtr</p> <p><i>event-name</i> / <i>event-number</i> — To generate, suppress, or revert to default for a single event, enter the specific number or event short name. If no event number or name is specified, the command</p>

applies to all events in the application. To display a list of all event short names use the **event-control** command.

Default none

Values A valid event name or event number.

generate — Specifies that logger event is created when this event occurs. The generate keyword can be used with two optional parameters, *severity-level* and **throttle**.

Default generate

severity-name — An ASCII string representing the severity level to associate with the specified generated events

Default The system assigned severity name

Values One of: cleared, indeterminate, critical, major, minor, warning.

throttle — Specifies whether or not events of this type will be throttled.
By default, event throttling is on for most event types.

suppress — This keyword indicates that the specified events will not be logged. If the **suppress** keyword is not specified then the events are generated by default. For example, **event-control bgp suppress** will suppress all BGP events.

Default generate

specific-throttle-rate *events-limit* — The log event throttling rate can be configured independently for each log event using this keyword. This specific-throttle-rate overrides the globally configured throttle rate (**configure>log>throttle-rate**) for the specific log event.

Values 1 — 20000

interval *seconds* — specifies the number of seconds that the specific throttling intervals lasts.

Values 1 — 1200

disable-specific-throttle — Specifies to disable the **specific-throttle-rate**.

event-damping

Syntax [no] event-damping

Context config>log

Description This command allows the user to set the event damping algorithm to suppress QoS or filter change events.

Note that while this event damping is original behavior for some modules such as service manager, QoS, and filters it can result in the NMS system database being out of sync because of missed change events. On the other hand, if the damping is disabled (**no event-damping**), it may take much longer for a large CLI configuration file to be processed when manually “exceed” after system bootup.

route-preference

Syntax	route-preference primary {inband outband} secondary {inband outband none} no route-preference
Context	config>log
Description	This command specifies the primary and secondary routing preference for traffic generated for SNMP notifications and syslog messages. If the remote destination is not reachable through the routing context specified by primary route preference then the secondary routing preference will be attempted. The no form of the command reverts to the default values.
Default	no route-preference
Parameters	<p>primary — Specifies the primary routing preference for traffic generated for SNMP notifications and syslog messages.</p> <p>Default outband</p> <p>secondary — Specifies the secondary routing preference for traffic generated for SNMP notifications and syslog messages. The routing context specified by the secondary route preference will be attempted if the remote destination was not reachable by the primary routing preference, specified by primary route preference. The value specified for the secondary routing preference must be distinct from the value for primary route preference.</p> <p>Default inband</p> <p>inband — Specifies that the logging utility will attempt to use the base routing context to send SNMP notifications and syslog messages to remote destinations.</p> <p>outband — Specifies that the logging utility will attempt to use the management routing context to send SNMP notifications and syslog messages to remote destinations.</p> <p>none — Specifies that no attempt will be made to send SNMP notifications and syslog messages to remote destinations.</p>

Log File Commands

file-id

- Syntax** [no] **file-id** *file-id*
- Context** config>log
- Description** This command creates the context to configure a file ID template to be used as a destination for an event log or billing file.
- This command defines the file location and characteristics that are to be used as the destination for a log event message stream or accounting/billing information. The file defined in this context is subsequently specified in the **to** command under **log-id** or **accounting-policy** to direct specific logging or billing source streams to the file destination.
- A file ID can only be assigned to either *one* **log-id** or *one* **accounting-policy**. It cannot be reused for multiple instances. A file ID and associated file definition must exist for each log and billing file that must be stored in the file system.
- A file is created when the file ID defined in this command is selected as the destination type for a specific log or accounting record. Log files are collected in a “log” directory. Accounting files are collected in an “act” directory.

The file names for a log are created by the system as summarized in the table below:

File Type	File Name
Log File	<i>logllff-timestamp</i>
Accounting File	<i>actaaff-timestamp</i>

Where:

- *ll* is the *log-id*
- *aa* is the accounting *policy-id*
- *ff* is the file-id
- The *timestamp* is the actual timestamp when the file is created. The format for the timestamp is *yyyymmdd-hhmmss* where:
 - *yyyy* is the year (for example, 2006)
 - *mm* is the month number (for example, 12 for December)
 - *dd* is the day of the month (for example, 03 for the 3rd of the month)
 - *hh* is the hour of the day in 24 hour format (for example, 04 for 4 a.m.)
 - *mm* is the minutes (for example, 30 for 30 minutes past the hour)
 - *ss* is the number of seconds (for example, 14 for 14 seconds)
- The accounting file is compressed and has a *gz* extension.

When initialized, each file will contain:

- The *log-id* description.
- The time the file was opened.
- The reason the file was created.
- If the event log file was closed properly, the sequence number of the last event stored on the log is recorded.

If the process of writing to a log file fails (for example, the compact flash card is full) and if a backup location is not specified or fails, the log file will not become operational even if the compact flash card is replaced. Enter either a **clear log** command or a **shutdown/no shutdown** command to reinitialize the file.

If the primary location fails (for example, the compact flash card fills up during the write process), a trap is sent and logging continues to the specified backup location. This can result in truncated files in different locations.

The **no** form of the command removes the *file-id* from the configuration. A *file-id* can only be removed from the configuration if the file is not the designated output for a log destination. The actual file remains on the file system.

Default No default file IDs are defined.

Parameters *file-id* — The file identification number for the file, expressed as a decimal integer.

Values 1 — 99

location

Syntax **location** *cflash-id* [*backup-cflash-id*]
no location

Context config>log>file *file-id*

Description This command specifies the primary and optional backup location where the log or billing file will be created.

The **location** command is optional. If the location command not explicitly configured, log files will be created on cf1: and accounting files will be created on cf2: without overflow onto other devices. Generally, cf3: is reserved for system files (configurations, images, etc.).

When multiple location commands are entered in a single file ID context, the last command overwrites the previous command.

When the location of a file ID that is associated with an active log ID is changed, the log events are not immediately written to the new location. The new location does not take affect until the log is rolled over either because the rollover period has expired or a **clear log** *log-id* command is entered to manually rollover the log file.

When creating files, the primary location is used as long as there is available space. If no space is available, an attempt is made to delete unnecessary files that are past their retention date.

If sufficient space is not available an attempt is made to remove the oldest to newest closed log or accounting files. After each file is deleted, the system attempts to create the new file.

A medium severity trap is issued to indicate that a compact flash is either not available or that no space is available on the specified flash and that the backup location is being used.

A high priority alarm condition is raised if none of the configured compact flash devices for this file ID are present or if there is insufficient space available. If space does becomes available, then the alarm condition will be cleared.

Use the **no** form of this command to revert to default settings.

Default Log files are created on cf1: and accounting files are created on cf2:.

Parameters *cf-flash-id* — Specify the primary location.

Values cflash-id: cf1:, cf2:, cf3:

backup-cflash-id — Specify the secondary location.

Values cflash-id: cf1:, cf2:, cf3:

rollover

Syntax **rollover** *minutes* [**retention** *hours*]
no rollover

Context config>log>file *file-id*

Description This command configures how often an event or accounting log is rolled over or partitioned into a new file.

An event or accounting log is actually composed of multiple, individual files. The system creates a new file for the log based on the **rollover** time, expressed in minutes.

The **retention** option, expressed in hours, allows you to modify the default time to keep the file in the system. The retention time is based on the rollover time of the file.

When multiple **rollover** commands for a *file-id* are entered, the last command overwrites the previous command.

Default **rollover 1440 retention 12**

Parameters *minutes* — The rollover time, in minutes.

Values 5 — 10080

retention hours. The retention period in hours, expressed as a decimal integer. The retention time is based on the time creation time of the file. The file becomes a candidate for removal once the creation datestamp + rollover time + retention time is less than the current timestamp.

Default 12

Values 1 — 500

Log Filter Commands

filter

Syntax	[no] filter <i>filter-id</i>
Context	config>log
Description	<p>This command creates a context for an event filter. An event filter specifies whether to forward or drop an event or trap based on the match criteria.</p> <p>Filters are configured in the filter <i>filter-id</i> context and then applied to a log in the log-id <i>log-id</i> context. Only events for the configured log source streams destined to the log ID where the filter is applied are filtered.</p> <p>Any changes made to an existing filter, using any of the sub-commands, are immediately applied to the destinations where the filter is applied.</p> <p>The no form of the command removes the filter association from log IDs which causes those logs to forward all events.</p>
Default	No event filters are defined.
Parameters	filter-id — The filter ID uniquely identifies the filter.
	Values 1 — 1000

default-action

Syntax	default-action { drop forward } no default-action
Context	config>log>filter <i>filter-id</i>
Description	<p>The default action specifies the action that is applied to events when no action is specified in the event filter entries or when an event does not match the specified criteria.</p> <p>When multiple default-action commands are entered, the last command overwrites the previous command.</p> <p>The no form of the command reverts the default action to the default value (forward).</p>
Default	default-action forward — The events which are not explicitly dropped by an event filter match are forwarded.
Parameters	<p>drop — The events which are not explicitly forwarded by an event filter match are dropped.</p> <p>forward — The events which are not explicitly dropped by an event filter match are forwarded.</p>

Log Filter Entry Commands

action

Syntax	
Syntax	action { drop forward } no action
Context	config>log>filter <i>filter-id</i> >entry <i>entry-id</i>
Description	<p>This command specifies a drop or forward action associated with the filter entry. If neither drop nor forward is specified, the default-action will be used for traffic that conforms to the match criteria. This could be considered a No-Op filter entry used to explicitly exit a set of filter entries without modifying previous actions.</p> <p>Multiple action statements entered will overwrite previous actions.</p> <p>The no form of the command removes the specified action statement.</p>
Default	Action specified by the default-action command will apply.
Parameters	drop — Specifies packets matching the entry criteria will be dropped. forward — Specifies packets matching the entry criteria will be forwarded.

entry

Syntax	[no] entry <i>entry-id</i>
Context	config>log>filter <i>filter-id</i>
Description	<p>This command is used to create or edit an event filter entry. Multiple entries may be created using unique <i>entry-id</i> numbers. The TiMOS implementation exits the filter on the first match found and executes the action in accordance with the action command.</p> <p>Comparisons are performed in an ascending entry ID order. When entries are created, they should be arranged sequentially from the most explicit entry to the least explicit. Matching ceases when a packet matches an entry. The entry action is performed on the packet, either drop or forward. To be considered a match, the packet must meet all the conditions defined in the entry.</p> <p>An entry may not have any match criteria defined (in which case, everything matches) but must have at least the keyword action for it to be considered complete. Entries without the action keyword will be considered incomplete and are rendered inactive.</p> <p>The no form of the command removes the specified entry from the event filter. Entries removed from the event filter are immediately removed from all log-id's where the filter is applied.</p>
Default	No event filter entries are defined. An entry must be explicitly configured.

Parameters *entry-id*. The entry ID uniquely identifies a set of match criteria corresponding action within a filter. Entry ID values should be configured in staggered increments so you can insert a new entry in an existing policy without renumbering the existing entries.

Values 1 — 999

Log Filter Entry Match Commands

match

Syntax	[no] match
Context	config>log>filter <i>filter-id</i> >entry <i>entry-id</i>
Description	<p>This command creates context to enter/edit match criteria for a filter entry. When the match criteria is satisfied, the action associated with the entry is executed.</p> <p>If more than one match parameter (within one match statement) is specified, then all the criteria must be satisfied (AND functional) before the action associated with the match is executed.</p> <p>Use the application command to display a list of the valid applications.</p> <p>Match context can consist of multiple match parameters (application, event-number, severity, subject), but multiple match statements cannot be entered per entry.</p> <p>The no form of the command removes the match criteria for the <i>entry-id</i>.</p>
Default	No match context is defined.

application

Syntax	application {eq neq} application-id no application
Context	config>log>filter <i>filter-id</i> >entry <i>entry-id</i> >match
Description	<p>This command adds an OS application as an event filter match criterion.</p> <p>An OS application is the software entity that reports the event. Applications include IP, MPLS, OSPF, CLI, SERVICES etc. Only one application can be specified. The latest application command overwrites the previous command.</p> <p>The no form of the command removes the application as a match criterion.</p>
Default	no application — No application match criterion is specified.
Parameters	eq neq — The operator specifying the type of match. Valid operators are listed in the table below.

Operator	Notes
eq	equal to
neq	not equal to

application-id — The application name string.

Values application_assurance, aps, atm, bgp, cflowd, chassis, debug, dhcp, dhcps, diameter, dynsvc, efm_oam, elmi, ering, eth_cfm, etun, fiter, gsmpp, igh, igmp,

igmp_snooping, ip, ipsec, isis, l2tp, lag, ldp, li, lldp, logger, mcpath, mc_redundancy, mirror, mld, mld_snooping, mpls, mpls_tp, msdp, nat, ntp, oam, open_flow, ospf, pim, pim_snooping, port, ppp, pppoe, ptp, radius, rip, rip_ng, route_policy, rsvp, security, snmp, stp, svcmgr, system, user, video, vrrp, vrtr, wlan_gw, wpp

number

- Syntax** **number** {**eq** | **neq** | **lt** | **lte** | **gt** | **gte**} *event-id*
no number
- Context** config>log>filter *filter-id*>entry *entry-id*>match
- Description** This command adds an SR OS application event number as a match criterion. SR OS event numbers uniquely identify a specific logging event within an application. Only one **number** command can be entered per event filter entry. The latest **number** command overwrites the previous command. The **no** form of the command removes the event number as a match criterion.
- Default** **no event-number** — No event ID match criterion is specified.
- Parameters** **eq** | **neq** | **lt** | **lte** | **gt** | **gte** — This operator specifies the type of match. Valid operators are listed in the table below. Valid operators are:

Operator	Notes
eq	equal to
neq	not equal to
lt	less than
lte	less than or equal to
gt	greater than
gte	greater than or equal to

event-id — The event ID, expressed as a decimal integer.

Values 1 — 4294967295

router

Syntax	router { eq neq } <i>router-instance</i> [regexp] no router
Context	config>log>filter>entry>match
Description	This command specifies the log event matches for the router.
Parameters	eq — Determines if the matching criteria should be equal to the specified value. neq — Determines if the matching criteria should not be equal to the specified value. <i>router-instance</i> — Specifies a router name up to 32 characters to be used in the match criteria. regexp — Specifies the type of string comparison to use to determine if the log event matches the value of router command parameters. When the regexp keyword is specified, the string in the router command is a regular expression string that will be matched against the subject string in the log event being filtered.

severity

Syntax	severity { eq neq lt lte gt gte } <i>severity-level</i> no severity
Context	config>log>filter>entry>match
Description	This command adds an event severity level as a match criterion. Only one severity command can be entered per event filter entry. The latest severity command overwrites the previous command. The no form of the command removes the severity match criterion.
Default	no severity — No severity level match criterion is specified.
Parameters	eq neq lt lte gt gte — This operator specifies the type of match. Valid operators are listed in the table below.

Operator	Notes
eq	equal to
neq	not equal to
lt	less than
lte	less than or equal to
gt	greater than
gte	greater than or equal to

severity-name — The ITU severity level name. The following table lists severity names and corresponding numbers per ITU standards M.3100 X.733 & X.21 severity levels.

Severity Number	Severity Name
1	cleared
2	indeterminate (info)
3	critical
4	major
5	minor
6	warning

Values cleared, intermediate, critical, major, minor, warning

subject

Syntax **subject** {**eq**|**neq**} *subject* [**regexp**]
no subject

Context config>log>filter *filter-id*>entry *entry-id*>match

Description This command adds an event subject as a match criterion.

The subject is the entity for which the event is reported, such as a port. In this case the port-id string would be the subject. Only one **subject** command can be entered per event filter entry. The latest **subject** command overwrites the previous command.

The **no** form of the command removes the subject match criterion.

Default **no subject** — No subject match criterion specified.

Parameters **eq** | **neq** — This operator specifies the type of match. Valid operators are listed in the following table:

Operator	Notes
eq	equal to
neq	not equal to

subject — A string used as the subject match criterion.

regexp — Specifies the type of string comparison to use to determine if the log event matches the value of **subject** command parameters. When the **regexp** keyword is specified, the string in the **subject** command is a regular expression string that will be matched against the subject string in the log event being filtered. When the **regexp** keyword is not specified, the **subject** command string is matched exactly by the event filter.

Syslog Commands

syslog

Syntax	[no] syslog <i>syslog-id</i>
Context	config>log
Description	<p>This command creates the context to configure a syslog target host that is capable of receiving selected syslog messages from this network element.</p> <p>A valid <i>syslog-id</i> must have the target syslog host address configured.</p> <p>A maximum of 10 <i>syslog-id</i>'s can be configured.</p> <p>No log events are sent to a syslog target address until the <i>syslog-id</i> has been configured as the log destination (to) in the <i>log-id</i> node.</p> <p>The syslog ID configured in the configure/service/vprn context has a local VPRN scope and only needs to be unique within the specific VPRN instance. The same ID can be reused under a different VPRN service or in the global log context under config>log.</p>
Default	No syslog IDs are defined.
Parameters	<i>syslog-id</i> — The syslog ID number for the syslog destination, expressed as a decimal integer.
Values	1 — 10

address

Syntax	address <i>ip-address</i> no address				
Context	config>log>syslog <i>syslog-id</i>				
Description	<p>This command adds the syslog target host IP address to/from a syslog ID.</p> <p>This parameter is mandatory. If no address is configured, syslog data cannot be forwarded to the syslog target host.</p> <p>Only one address can be associated with a <i>syslog-id</i>. If multiple addresses are entered, the last address entered overwrites the previous address.</p> <p>The same syslog target host can be used by multiple log IDs.</p> <p>The no form of the command removes the syslog target host IP address.</p>				
Default	no address — There is no syslog target host IP address defined for the syslog ID.				
Parameters	<i>ip-address</i> — The IP address of the syslog target host in dotted decimal notation.				
Values	<table> <tr> <td>ipv4-address</td> <td>a.b.c.d</td> </tr> <tr> <td>ipv6-address</td> <td>x:x:x:x:x:x[-interface]</td> </tr> </table>	ipv4-address	a.b.c.d	ipv6-address	x:x:x:x:x:x[-interface]
ipv4-address	a.b.c.d				
ipv6-address	x:x:x:x:x:x[-interface]				

```
x:x:x:x:x:d.d.d.d[-interface]
x: [0..FFFF]H
d: [0..255]D
interface: 32 characters maximum, mandatory for link local
addressesipv6-addressx:x:x:x:x:x[-interface]
x:x:x:x:x:d.d.d.d[-interface]
x: [0..FFFF]H
d: [0..255]D
interface: 32 characters maximum, mandatory for link local
addresses
```

facility

- Syntax** `facility syslog-facility`
no facility
- Context** `config>log>syslog syslog-id`
- Description** This command configures the facility code for messages sent to the syslog target host.
- Multiple syslog IDs can be created with the same target host but each syslog ID can only have one facility code. If multiple facility codes are entered, the last *facility-code* entered overwrites the previous facility-code.
- If multiple facilities need to be generated for a single syslog target host, then multiple **log-id** entries must be created, each with its own filter criteria to select the events to be sent to the syslog target host with a given facility code.
- The **no** form of the command reverts to the default value.
- Default** `local7` — syslog entries are sent with the local7 facility code.
- Parameters** `syslog-facility` — The syslog facility name represents a specific numeric facility code. The code should be entered in accordance with the syslog RFC. However, the software does not validate if the facility code configured is appropriate for the event type being sent to the syslog target host.
- Values** kernel, user, mail, systemd, auth, syslogd, printer, netnews, uucp, cron, authpriv, ftp, ntp, logaudit, logalert, cron2, local0, local1, local2, local3, local4, local5, local6, local7
- Valid responses per RFC3164, *The BSD syslog Protocol*, are listed in the table below.

Numerical Code	Facility Code
0	kernel
1	user
2	mail
3	systemd
4	auth
5	syslogd
6	printer

Numerical Code	Facility Code
7	net-news
8	uucp
9	cron
10	auth-priv
11	ftp
12	ntp
13	log-audit
14	log-alert
15	cron2
16	local0
17	local1
18	local2
19	local3
20	local4
21	local5
22	local6
23	local7

Values 0 — 23

log-prefix

Syntax	log-prefix <i>log-prefix-string</i> no log-prefix
Context	config>log>syslog <i>syslog-id</i>
Description	<p>This command adds the string prepended to every syslog message sent to the syslog host. RFC3164, <i>The BSD syslog Protocol</i>, allows an alphanumeric string (tag) to be prepended to the content of every log message sent to the syslog host. This alphanumeric string can, for example, be used to identify the node that generates the log entry. The software appends a colon (:) and a space to the string and it is inserted in the syslog message after the date stamp and before the syslog message content.</p> <p>Only one string can be entered. If multiple strings are entered, the last string overwrites the previous string. The alphanumeric string can contain lowercase (a-z), uppercase (A-Z) and numeric (0-9) characters.</p> <p>The no form of the command removes the log prefix string.</p>
Default	no log-prefix — no prepend log prefix string defined.
Parameters	<i>log-prefix-string</i> — An alphanumeric string of up to 32 characters. Spaces and colons (:) cannot be used in the string.

level

- Syntax** **level** *syslog-level*
no level
- Context** config>log>syslog *syslog-id*
- Description** This command configures the syslog message severity level threshold. All messages with severity level equal to or higher than the threshold are sent to the syslog target host.
- Only a single threshold level can be specified. If multiple levels are entered, the last **level** entered will overwrite the previously entered commands.
- The **no** form of the command reverts to the default value.
- Parameters** *value* — The threshold severity level name.
- Values** emergency, alert, critical, error, warning, notice, info, debug

Router severity level	Numerical Severity (highest to lowest)	Configured Severity	Definition
	0	emergency	system is unusable
3	1	alert	action must be taken immediately
4	2	critical	critical condition
5	3	error	error condition
6	4	warning	warning condition
	5	notice	normal but significant condition
1 cleared 2 indeterminate	6	info	informational messages
	7	debug	debug-level messages

port

- Syntax** **port** *value*
no port
- Context** config>log>syslog *syslog-id*
- Description** This command configures the UDP port that will be used to send syslog messages to the syslog target host.
- The port configuration is needed if the syslog target host uses a port other than the standard UDP syslog port 514.

Only one port can be configured. If multiple **port** commands are entered, the last entered port overwrites the previously entered ports.

The **no** form of the command reverts to default value.

Default **no port**

Parameters *value* — The value is the configured UDP port number used when sending syslog messages.

Values 1 — 65535

throttle-rate

Syntax **throttle-rate** *events* [*interval seconds*]
no throttle-rate

Context config>log

Description This command configures an event throttling rate.

Parameters *events* — Specifies the number of log events that can be logged within the specified interval for a specific event. Once the limit has been reached, any additional events of that type will be dropped, for example, the event drop count will be incremented. At the end of the throttle interval if any events have been dropped a trap notification will be sent.

Values 1 — 20000

Default 2000

interval seconds — Specifies the number of seconds that an event throttling interval lasts.

Values 1 — 1200

Default 1

SNMP Trap Groups

snmp-trap-group

Syntax	<code>[no] snmp-trap-group log-id</code>
Context	<code>config>log</code>
Description	<p>This command creates the context to configure a group of SNMP trap receivers and their operational parameters for a given log-id.</p> <p>A group specifies the types of SNMP traps and specifies the log ID which will receive the group of SNMP traps. A trap group must be configured in order for SNMP traps to be sent.</p> <p>To suppress the generation of all alarms and traps see the event-control command. To suppress alarms and traps that are sent to this log-id, see the filter command. Once alarms and traps are generated they can be directed to one or more SNMP trap groups. Logger events that can be forwarded as SNMP traps are always defined on the main event source.</p> <p>The no form of the command deletes the SNMP trap group.</p>
Default	There are no default SNMP trap groups.
Parameters	<p><i>log-id</i> — The log ID value of a log configured in the log-id context. Alarms and traps cannot be sent to the trap receivers until a valid <i>log-id</i> exists.</p> <p>Values 1 — 99</p>

trap-target

Syntax	<code>trap-target name [address ip-address] [port port] [snmpv1 snmpv2c snmpv3] notify-community communityName snmpv3SecurityName [security-level {no-auth-no-privacy auth-no-privacy privacy}] [replay]</code> <code>no trap-target name</code>
Context	<code>config>log>snmp-trap-group</code>
Description	<p>This command adds/modifies a trap receiver and configures the operational parameters for the trap receiver. A trap reports significant events that occur on a network device such as errors or failures.</p> <p>Before an SNMP trap can be issued to a trap receiver, the log-id, snmp-trap-group and at least one trap-target must be configured.</p> <p>The trap-target command is used to add/remove a trap receiver from an snmp-trap-group. The operational parameters specified in the command include:</p> <ul style="list-style-type: none"> • The IP address of the trap receiver • The UDP port used to send the SNMP trap • SNMP version

- SNMP community name for SNMPv1 and SNMPv2c receivers.
- Security name and level for SNMPv3 trap receivers.

A single **snmp-trap-group** *log-id* can have multiple trap-receivers. Each trap receiver can have different operational parameters.

An address can be configured as a trap receiver more than once as long as a different port is used for each instance.

To prevent resource limitations, only configure a maximum of 10 trap receivers.

Note that if the same **trap-target name port** parameter value is specified in more than one SNMP trap group, each trap destination should be configured with a different *notify-community* value. This allows a trap receiving an application, such as NMS, to reconcile a separate event sequence number stream for each router event log when multiple event logs are directed to the same IP address and port destination.

The **no** form of the command removes the SNMP trap receiver from the SNMP trap group.

Default No SNMP trap targets are defined.

Parameters *name* — Specifies the name of the trap target up to 28 characters in length.

address ip-address — The IP address of the trap receiver in dotted decimal notation. Only one IP address destination can be specified per trap destination group.

Values	ip4-address	a.b.c.d (host bits must be 0)
	ip6-address	x:x:x:x:x:x[-interface] x:x:x:x:x:d.d.d.d[-interface] x: [0..FFFF]H d: [0..255]D interface: 32 characters maximum, mandatory for link local addresses

port port — The destination UDP port used for sending traps to the destination, expressed as a decimal integer. Only one port can be specified per **trap-target** statement. If multiple traps need to be issued to the same address then multiple ports must be configured.

Default 162

Values 1 — 65535

snmpv1 | *snmpv2c* | *snmpv3* — Specifies the SNMP version format to use for traps sent to the trap receiver.

The keyword **snmpv1** selects the SNMP version 1 format. When specifying **snmpv1**, the **notify-community** must be configured for the proper SNMP community string that the trap receiver expects to be present in alarms and traps messages. If the SNMP version is changed from **snmpv3** to **snmpv1**, then the **notify-community** parameter must be changed to reflect the community string rather than the *security-name* that is used by **snmpv3**.

The keyword **snmpv2c** selects the SNMP version 2c format. When specifying **snmpv2c**, the **notify-community** must be configured for the proper SNMP community string that the trap receiver expects to be present in alarms and traps messages. If the SNMP version is changed from **snmpv3** to **snmpv2c**, then the **notify-community** parameter must be changed to reflect the community string rather than the *security-name* that is used by **snmpv3**.

The keyword **snmpv3** selects the SNMP version 3 format. When specifying **snmpv3**, the **notify-community** must be configured for the SNMP *security-name*. If the SNMP version is changed from **snmpv1** or **snmpv2c** to **snmpv3**, then the **notify-community** parameter must be changed to reflect the *security-name* rather than the community string used by **snmpv1** or **snmpv2c**.

Pre-existing conditions are checked before the `snmpv3SecurityName` is accepted. These are:

- The user name must be configured.
- The v3 access group must be configured.
- The v3 notification view must be configured.

Default `snmpv3`

Values `snmpv1, snmpv2c, snmpv3`

notify-community *community | security-name* — Specifies the community string for **snmpv1** or **snmpv2c** or the **snmpv3** *security-name*. If no **notify-community** is configured, then no alarms nor traps will be issued for the trap destination. If the SNMP version is modified, the **notify-community** must be changed to the proper form for the SNMP version.

community — The community string as required by the **snmpv1** or **snmpv2c** trap receiver. The community string can be an ASCII string up to 31 characters in length.

security-name — The *security-name* as defined in the `config>system>security>user` context for SNMP v3. The *security-name* can be an ASCII string up to 31 characters in length.

security-level {*no-auth-no-privacy | auth-no-privacy | privacy*} — Specifies the required authentication and privacy levels required to access the views configured on this node when configuring an **snmpv3** trap receiver.

The keyword **no-auth-no-privacy** specifies no authentication and no privacy (encryption) are required.

The keyword **auth-no-privacy** specifies authentication is required but no privacy (encryption) is required. When this option is configured the *security-name* must be configured for **authentication**.

The keyword **privacy** specifies both authentication and privacy (encryption) is required. When this option is configured the *security-name* must be configured for **authentication** and **privacy**.

Default `no-auth-no-privacy`. This parameter can only be configured if SNMPv3 is also configured.

Values `no-auth-no-privacy, auth-no-privacy, privacy`

replay — Enable replay of missed events to target. If replay is applied to an SNMP trap target address, the address is monitored for reachability. Reachability is determined by whether or not there is a route in the routing table by which the target address can be reached. Before sending a trap to a target address, the SNMP module asks the PIP module if there is either an in-band or out-of-band route to the target address. If there is no route to the SNMP target address, the SNMP module saves the sequence-id of the first event that will be missed by the trap target. When the routing table changes again so that there is now a route by which the SNMP target address can be reached, the SNMP module replays (for example, retransmits) all events generated to the SNMP notification log while the target address was removed from the route table. Note that because of route table change convergence time, it is possible that one or more events may be lost at the beginning or end of a replay sequence. The cold-start-wait and route-

recovery-wait timers under `config>log>app-route-notifications` can help reduce the probability of lost events.

filter

Syntax	filter <i>filter-id</i> no filter
Context	<code>config>log>log-id</code> <i>log-id</i>
Description	<p>This command adds an event filter policy with the log destination.</p> <p>The filter command is optional. If no event filter is configured, all events, alarms and traps generated by the source stream will be forwarded to the destination.</p> <p>An event filter policy defines (limits) the events that are forwarded to the destination configured in the <i>log-id</i>. The event filter policy can also be used to select the alarms and traps to be forwarded to a destination snmp-trap-group.</p> <p>The application of filters for debug messages is limited to application and subject only.</p> <p>Accounting records cannot be filtered using the filter command.</p> <p>Only one <i>filter-id</i> can be configured per log destination.</p> <p>The no form of the command removes the specified event filter from the <i>log-id</i>.</p>
Default	no filter — No event filter policy is specified for a <i>log-id</i> .
Parameters	<p><i>filter-id</i>. The event filter policy ID is used to associate the filter with the <i>log-id</i> configuration. The event filter policy ID must already be defined in config>log>filter <i>filter-id</i>.</p> <p>Values 1 — 1000</p>

from

Syntax	from {[main] [security] [change] [debug-trace] } no from
Context	<code>config>log>log-id</code> <i>log-id</i>
Description	<p>This command selects the source stream to be sent to a log destination.</p> <p>One or more source streams must be specified. The source of the data stream must be identified using the from command before you can configure the destination using the to command. The from command can identify multiple source streams in a single statement (for example: from main change debug-trace).</p> <p>Only one from command may be entered for a single <i>log-id</i>. If multiple from commands are configured, then the last command entered overwrites the previous from command.</p> <p>The no form of the command removes all previously configured source streams.</p>
Default	No source stream is configured.

- Parameters**
- main** — Instructs all events in the main event stream to be sent to the destination defined in the **to** command for this destination *log-id*. The main event stream contains the events that are not explicitly directed to any other event stream. To limit the events forwarded to the destination, configure filters using the **filter** command.
 - security** — Instructs all events in the security event stream to be sent to the destination defined in the **to** command for this destination *log-id*. The security stream contains all events that affect attempts to breach system security such as failed login attempts, attempts to access MIB tables to which the user is not granted access or attempts to enter a branch of the CLI to which access has not been granted. To limit the events forwarded to the destination, configure filters using the **filter** command.
 - change** — Instructs all events in the user activity stream to be sent to the destination configured in the **to** command for this destination *log-id*. The change event stream contains all events that directly affect the configuration or operation of this node. To limit the events forwarded to the change stream destination, configure filters using the **filter** command.
 - debug-trace** — Instructs all debug-trace messages in the debug stream to be sent to the destination configured in the **to** command for this destination *log-id*. Filters applied to debug messages are limited to application and subject.

log-id

- Syntax** [no] **log-id** *log-id*
- Context** config>log
- Description** This command creates a context to configure destinations for event streams.
- The **log-id** context is used to direct events, alarms/traps, and debug information to respective destinations.
- A maximum of 10 logs can be configured.
- Before an event can be associated with this *log-id*, the **from** command identifying the source of the event must be configured.
- Only one destination can be specified for a *log-id*. The destination of an event stream can be an in-memory buffer, console, session, snmp-trap-group, syslog, or file.
- Use the **event-control** command to suppress the generation of events, alarms, and traps for all log destinations.
- An event filter policy can be applied in the *log-id* context to limit which events, alarms, and traps are sent to the specified *log-id*.
- Log-IDs 99 and 100 are created by the agent. Log-ID 99 captures all log messages. Log-ID 100 captures log messages with a severity level of major and above.
- Note that Log-ID 99 provides valuable information for the admin-tech file. Removing or changing the log configuration may hinder debugging capabilities. It is strongly recommended not to alter the configuration for Log-ID 99.
- The **no** form of the command deletes the log destination ID from the configuration.

SNMP Trap Groups

Default No log destinations are defined.

Parameters *log-id* — The log ID number, expressed as a decimal integer.

Values 1 — 100

to console

Syntax **to console**

Context config>log>log-id *log-id*

Description This command specifies a log ID destination. This parameter is mandatory when configuring a log destination. This command instructs the events selected for the log ID to be directed to the console. If the console is not connected, then all the entries are dropped.

The source of the data stream must be specified in the **from** command prior to configuring the destination with the **to** command.

The **to** command cannot be modified or re-entered. If the destination or maximum size of an SNMP or memory log needs to be modified, the log ID must be removed and then re-created.

Default No destination is specified.

to file

Syntax **to file** *log-file-id*

Context config>log>log-id *log-id*

Description This command specifies a log ID destination. This parameter is mandatory when configuring a log destination. This command instructs the events selected for the log ID to be directed to a specified file.

The source of the data stream must be specified in the **from** command prior to configuring the destination with the **to** command.

The **to** command cannot be modified or re-entered. If the destination or maximum size of an SNMP or memory log needs to be modified, the log ID must be removed and then re-created.

Default No destination is specified.

Parameters *log-file-id* — Instructs the events selected for the log ID to be directed to the *log-file-id*. The characteristics of the *log-file-id* referenced here must have already been defined in the **config>log>file** *log-file-id* context.

Values 1 — 99

to memory

Syntax	to memory [<i>size</i>]				
Context	config>log>log-id <i>log-id</i>				
Description	<p>This command specifies a log ID destination. This parameter is mandatory when configuring a log destination. This command instructs the events selected for the log ID to be directed to a memory log. A memory file is a circular buffer. Once the file is full, each new entry replaces the oldest entry in the log.</p> <p>The source of the data stream must be specified in the from command prior to configuring the destination with the to command.</p> <p>The to command cannot be modified or re-entered. If the destination or maximum size of an SNMP or memory log needs to be modified, the log ID must be removed and then re-created.</p>				
Default	none				
Parameters	<p><i>size</i> — The <i>size</i> parameter indicates the number of events that can be stored in the memory.</p> <table> <tr> <td>Default</td> <td>100</td> </tr> <tr> <td>Values</td> <td>50 — 1024</td> </tr> </table>	Default	100	Values	50 — 1024
Default	100				
Values	50 — 1024				

to session

Syntax	to session
Context	config>log>log-id <i>log-id</i>
Description	<p>This command specifies a log ID destination. This parameter is mandatory when configuring a log destination. This command instructs the events selected for the log ID to be directed to the current console or telnet session. This command is only valid for the duration of the session. When the session is terminated the log ID is removed. A log ID with a <i>session</i> destination is not saved in the configuration file.</p> <p>The source of the data stream must be specified in the from command prior to configuring the destination with the to command.</p> <p>The to command cannot be modified or re-entered. If the destination or maximum size of an SNMP or memory log needs to be modified, the log ID must be removed and then re-created.</p>
Default	none

to snmp

Syntax	to snmp [<i>size</i>]				
Context	config>log>log-id <i>log-id</i>				
Description	<p>This is one of the commands used to specify the log ID destination. This parameter is mandatory when configuring a log destination. This command instructs the alarms and traps to be directed to the snmp-trap-group associated with <i>log-id</i>.</p> <p>A local circular memory log is always maintained for SNMP notifications sent to the specified snmp-trap-group for the <i>log-id</i>.</p> <p>The source of the data stream must be specified in the from command prior to configuring the destination with the to command.</p> <p>The to command cannot be modified or re-entered. If the destination or maximum size of an SNMP or memory log needs to be modified, the log ID must be removed and then re-created.</p>				
Default	none				
Parameters	<p><i>size</i> — The <i>size</i> parameter defines the number of events stored in this memory log.</p> <table> <tr> <td>Default</td> <td>100</td> </tr> <tr> <td>Values</td> <td>50 — 1024</td> </tr> </table>	Default	100	Values	50 — 1024
Default	100				
Values	50 — 1024				

to syslog

Syntax	to syslog <i>syslog-id</i>		
Context	config>log>log-id		
Description	<p>This is one of the commands used to specify the log ID destination. This parameter is mandatory when configuring a log destination.</p> <p>This command instructs the alarms and traps to be directed to a specified syslog. To remain consistent with the standards governing syslog, messages to syslog are truncated to 1k bytes.</p> <p>The source of the data stream must be specified in the from command prior to configuring the destination with the to command.</p> <p>The to command cannot be modified or re-entered. If the destination or maximum size of an SNMP or memory log needs to be modified, the log ID must be removed and then re-created.</p>		
Default	none		
Parameters	<p><i>syslog-id</i> — Instructs the events selected for the log ID to be directed to the <i>syslog-id</i>. The characteristics of the <i>syslog-id</i> referenced here must have been defined in the config>log>syslog <i>syslog-id</i> context.</p> <table> <tr> <td>Values</td> <td>1 — 10</td> </tr> </table>	Values	1 — 10
Values	1 — 10		

time-format

Syntax	time-format {local utc}
Context	config>log>log-id
Description	This command specifies whether the time should be displayed in local or Coordinated Universal Time (UTC) format.
Default	utc
Parameters	local — Specifies that timestamps are written in the system's local time. utc — Specifies that timestamps are written using the UTC value. This was formerly called Greenwich Mean Time (GMT) and Zulu time.

Accounting Policy Commands

accounting-policy

Syntax	accounting-policy <i>policy-id</i> [interval <i>minutes</i>] no accounting-policy <i>policy-id</i>
Context	config>log
Description	<p>This command creates an access or network accounting policy. An accounting policy defines the accounting records that are created.</p> <p>Access accounting policies are policies that can be applied to one or more SAPs. Changes made to an existing policy, using any of the sub-commands, are applied immediately to all SAPs where this policy is applied.</p> <p>If an accounting policy is not specified on a SAP, then accounting records are produced in accordance with the access policy designated as the default. If a default access policy is not specified, then no accounting records are collected other than the records for the accounting policies that are explicitly configured.</p> <p>Only one policy can be regarded as the default access policy. If a policy is configured as the default policy, then a no default command must be used to allow the data that is currently being collected to be written before a new access default policy can be configured.</p> <p>Network accounting policies are policies that can be applied to one or more network ports or SONET/SDH channels. Any changes made to an existing policy, using any of the sub-commands, will be applied immediately to all network ports or SONET/SDH channels where this policy is applied.</p> <p>If no accounting policy is defined on a network port, accounting records will be produced in accordance with the default network policy as designated with the default command. If no network default policy is created, then no accounting records will be collected other than the records for the accounting policies explicitly configured.</p> <p>Only one policy can be regarded as the default network policy. If a policy is configured as the default policy, then a no default command must be used to allow the data that is currently being collected to be written before a new network default policy can be configured.</p> <p>The no form of the command deletes the policy from the configuration. The accounting policy cannot be removed unless it is removed from all the SAPs, network ports or channels where the policy is applied.</p>
Default	No default accounting policy is defined.
Parameters	<i>policy-id</i> — The policy ID that uniquely identifies the accounting policy, expressed as a decimal integer.
Values	1 — 99

collection-interval

Syntax	collection-interval <i>minutes</i> no collection-interval
Context	config>log>acct-policy
Description	This command configures the accounting collection interval.
Parameters	<i>minutes</i> — Specifies the interval between collections, in minutes.
Values	1 — 120 A range of 1 — 4 is only allowed when the record type is set to SAA.

auto-bandwidth

Syntax	[no] auto-bandwidth
Context	config>log>accounting-policy
Description	In the configuration of an accounting policy this designates the accounting policy as the one used for auto-bandwidth statistics collection.
Default	no auto-bandwidth

default

Syntax	[no] default
Context	config>log>accounting-policy
Description	<p>This command configures the default accounting policy to be used with all SAPs that do not have an accounting policy.</p> <p>If no access accounting policy is defined on a SAP, accounting records are produced in accordance with the default access policy. If no default access policy is created, then no accounting records will be collected other than the records for the accounting policies that are explicitly configured.</p> <p>If no network accounting policy is defined on a network port, accounting records will be produced in accordance with the default network policy. If no network default policy is created, then no accounting records will be collected other than the records for the accounting policies explicitly configured.</p> <p>Only one access accounting policy ID can be designated as the default access policy. Likewise, only one network accounting policy ID can be designated as the default network accounting policy.</p> <p>The record name must be specified prior to assigning an accounting policy as default.</p> <p>If a policy is configured as the default policy, then a no default command must be issued before a new default policy can be configured.</p>

The **no** form of the command removes the default policy designation from the policy ID. The accounting policy will be removed from all SAPs or network ports that do not have this policy explicitly defined.

include-router-info

Syntax	[no] include-router-info
Context	config>log>accounting-policy
Description	<p>This command allows operator to optionally include router information at the top of each accounting file generated for a given accounting policy.</p> <p>When the no version of this command is selected, optional router information is not include at the top of the file.</p>
Default	no include-router-info

include-system-info

Syntax	[no] include-system-info
Context	config>log>accounting-policy
Description	<p>This command allows the operator to optionally include router information at the top of each accounting file generated for a given accounting policy.</p> <p>When the no version of this command is selected, optional router information is not include at the top of the file.</p>
Default	no include-router-info

record

Syntax [no] record *record-name*

Context config>log>accounting-policy *policy-id*

Description This command adds the accounting record type to the accounting policy to be forwarded to the configured accounting file. A record name can only be used in one accounting policy. To obtain a list of all record types that can be configured, use the **show log accounting-records** command.

NOTE: aa, video and subscriber records are not applicable to the 7950 XRS.

```
A:ALA-49# show log accounting-records
=====
Accounting Policy Records
=====
Record # Record Name                               Def. Interval
-----
1      service-ingress-octets                        5
2      service-egress-octets                        5
3      service-ingress-packets                       5
4      service-egress-packets                       5
5      network-ingress-octets                       15
6      network-egress-octets                        15
7      network-ingress-packets                       15
8      network-egress-packets                       15
9      compact-service-ingress-octets               5
10     combined-service-ingress                      5
11     combined-network-ing-egr-octets              15
12     combined-service-ing-egr-octets              5
13     complete-service-ingress-egress              5
14     combined-sdp-ingress-egress                  5
15     complete-sdp-ingress-egress                  5
16     complete-subscriber-ingress-egress           5
17     aa-protocol                                  15
18     aa-application                              15
19     aa-app-group                                15
20     aa-subscriber-protocol                       15
21     aa-subscriber-application                    15
23     custom-record-subscriber                     5
24     custom-record-service                        5
25     custom-record-aa-sub                          15
26     queue-group-octets                           15
27     queue-group-packets                          15
28     combined-queue-group                         15
29     combined-mpls-lsp-ingress                    5
30     combined-mpls-lsp-egress                     5
31     combined-ldp-lsp-egress                      5
32     saa                                           5
33     complete-pm                                  5
34     video                                        10
35     kpi-system                                   5
36     kpi-bearer-mgmt                              5
37     kpi-bearer-traffic                           5
38     kpi-ref-point                                5
39     kpi-path-mgmt                                5
40     kci-iom-3                                    5
41     kci-system                                   5
42     kci-bearer-mgmt                              5
```

Accounting Policy Commands

```

43      kci-path-mgmt          5
44      complete-kpi          5
45      complete-kci          5
46      kpi-bearer-group      5
47      kpi-ref-path-group    5
48      kpi-kci-bearer-mgmt   5
49      kpi-kci-path-mgmt     5
50      kpi-kci-system        5
51      complete-kpi-kci      5
52      aa-performance        15
53      complete-ethernet-port 15
54      extended-service-ingress-egress 5
55      complete-network-ing-egr 15
56      aa-partition          15
57      complete-pm           5
0       unknown-record-name   0
59      kpi-bearer-traffic-gtp-endpoint 5
60      kpi-ip-reas           5
61      kpi-radius-group      5
62      kpi-ref-pt-failure-cause-code 5
63      kpi-dhcp-group        5
        complete-pm           5

```

```

=====
A:ALA-49#

```

To configure an accounting policy for access ports, select a service record (for example, `service-ingress-octets`). To change the record name to another service record then the record command with the new record name can be entered and it will replace the old record name.

When configuring an accounting policy for network ports, a network record should be selected. When changing the record name to another network record, the record command with the new record name can be entered and it will replace the old record name.

If the change required modifies the record from network to service or from service to network, then the old record name must be removed using the **no** form of this command.

Only one record may be configured in a single accounting policy. For example, if an accounting-policy is configured with a **access-egress-octets** record, in order to change it to **service-ingress-octets**, use the **no record** command under the accounting-policy to remove the old record and then enter the **service-ingress-octets** record.

Note that collecting excessive statistics can adversely affect the CPU utilization and take up large amounts of storage space.

The **no** form of the command removes the record type from the policy.

Default No accounting record is defined

Parameters *record-name* — The accounting record name. The following table lists the accounting record names available and the default collection interval.

Record Type	Accounting Record Name	Default Interval
1	<code>service-ingress-octets</code>	5
2	<code>service-egress-octets</code>	5

Record Type	Accounting Record Name	Default Interval
3	service-ingress-packets	5
4	service-egress-packets	5
5	network-ingress-octets	15
6	network-egress-octets	15
7	network-ingress-packets	15
8	network-egress-packets	15
9	compact-service-ingress-octets	5
10	combined-service-ingress	5
11	combined-network-ing-egr-octets	15
12	combined-service-ing-egr-octets	5
13	complete-service-ingress-egress	5
14	combined-sdp-ingress-egress	5
15	complete-sdp-ingress-egress	5
16	complete-subscriber-ingress-egress	5
17	aa-protocol	15
18	aa-application	15
19	aa-app-group	15
20	aa-subscriber-protocol	15
21	aa-subscriber-application	15
23	custom-record-subscriber	5
24	custom-record-service	5
25	custom-record-aa-sub	15
26	queue-group-octets	15
27	queue-group-packets	15
28	combined-queue-group	15
29	combined-mpls-lsp-ingress	5
30	combined-mpls-lsp-egress	5
31	combined-ldp-lsp-egress	5

Record Type	Accounting Record Name	Default Interval
3	service-ingress-packets	5
4	service-egress-packets	5
5	network-ingress-octets	15
6	network-egress-octets	15
7	network-ingress-packets	15
8	network-egress-packets	15
9	compact-service-ingress-octets	5
10	combined-service-ingress	5
11	combined-network-ing-egr-octets	15
12	combined-service-ing-egr-octets	5
13	complete-service-ingress-egress	5
14	combined-sdp-ingress-egress	5
15	complete-sdp-ingress-egress	5
16	complete-subscriber-ingress-egress	5
17	aa-protocol	15
18	aa-application	15
19	aa-app-group	15
20	aa-subscriber-protocol	15
21	aa-subscriber-application	15
23	custom-record-subscriber	5
24	custom-record-service	5
25	custom-record-aa-sub	15
26	queue-group-octets	15
27	queue-group-packets	15
28	combined-queue-group	15
29	combined-mpls-lsp-ingress	5
30	combined-mpls-lsp-egress	5
31	combined-ldp-lsp-egress	5

Record Type	Accounting Record Name	Default Interval
3	service-ingress-packets	5
4	service-egress-packets	5
5	network-ingress-octets	15
6	network-egress-octets	15
7	network-ingress-packets	15
8	network-egress-packets	15
9	compact-service-ingress-octets	5
10	combined-service-ingress	5
11	combined-network-ing-egr-octets	15
12	combined-service-ing-egr-octets	5
13	complete-service-ingress-egress	5
14	combined-sdp-ingress-egress	5
15	complete-sdp-ingress-egress	5
16	complete-subscriber-ingress-egress	5
17	aa-protocol	15
18	aa-application	15
19	aa-app-group	15
20	aa-subscriber-protocol	15
21	aa-subscriber-application	15
23	custom-record-subscriber	5
24	custom-record-service	5
25	custom-record-aa-sub	15
26	queue-group-octets	15
27	queue-group-packets	15
28	combined-queue-group	15
29	combined-mpls-lsp-ingress	5
30	combined-mpls-lsp-egress	5
31	combined-ldp-lsp-egress	5

Record Type	Accounting Record Name	Default Interval
32	saa	5
33	complete-pm	5
34	video	10
35	kpi-system	5
36	kpi-bearer-mgmt	5
37	kpi-bearer-traffic	5
38	kpi-ref-point	5
39	kpi-path-mgmt	5
40	kpi-iom-3	5
41	kci-system	5
42	kci-bearer-mgmt	5
43	kci-path-mgmt	5
44	complete-kpi	5
45	complete-kci	5
46	kpi-bearer-group	5
47	kpi-ref-path-group	5
48	kpi-kci-bearer-mgmt	5
49	kpi-kci-path-mgmt	5
50	kpi-kci-system	5
51	complete-kpi-kci	5
52	aa-performance	15
53	complete-ethernet-port	15
54	extended-service-ingress-egress	5
55	complete-network-ing-egr	15

to

Syntax **to file** *file-id*

Context config>log>accounting-policy *policy-id*

This command specifies the destination for the accounting records selected for the accounting policy.

Default No destination is specified.

Parameters *file-id* — The *file-id* option specifies the destination for the accounting records selected for this destination. The characteristics of the file-id must have already been defined in the config>log>file context. A file-id can only be used once.

The file is generated when the file policy is referenced. This command identifies the type of accounting file to be created. The file definition defines its characteristics.

If the **to** command is executed while the accounting policy is in operation, then it becomes active during the next collection interval.

Values 1 — 99

Accounting Policy Custom Record Commands

collection-interval

Syntax	collection-interval <i>minutes</i> no collection-interval
Context	config>log>acct-policy
Description	This command configures the accounting collection interval. The no form of the command returns the value to the default.
Default	60
Parameters	<i>minutes</i> — Specifies the collection interval in minutes. Values 5 — 120

custom-record

Syntax	[no] custom-record
Context	config>log>acct-policy
Description	This command enables the context to configure the layout and setting for a custom accounting record associated with this accounting policy. The no form of the command reverts the configured values to the defaults.

aa-specific

Syntax	[no] aa-specific
Context	config>log>acct-policy>cr
Description	This command enables the context to configure information for this custom record. The no form of the command

aa-sub-counters

Syntax	aa-sub-counters [all] no aa-sub-counters
Context	config>log>acct-policy>cr>aa
Description	This command enables the context to configure subscriber counter information. The no form of the command
Parameters	all — Specifies all counters.

long-duration-flow-count

Syntax	long-duration-flow-count
Context	config>log>acct-policy>cr>aa>aa-sub-cntr
Description	This command includes the long duration flow count. The no form of the command excludes the long duration flow count in the AA subscriber's custom record.
Default	no long-duration-flow-count

medium-duration-flow-count

Syntax	[no] medium-duration-flow-count
Context	config>log>acct-policy>cr>aa>aa-sub-cntr
Description	This command includes the medium duration flow count in the AA subscriber's custom record. The no form of the command excludes the medium duration flow count.
Default	no medium-duration-flow-count

short-duration-flow-count

Syntax	[no] short-duration-flow-count
Context	config>log>acct-policy>cr>aa>aa-sub-cntr
Description	This command includes the short duration flow count in the AA subscriber's custom record. The no form of the command excludes the short duration flow count.
Default	no short-duration-flow-count

total-flow-duration

- Syntax** [no] total-flow-duration
- Context** config>log>acct-policy>cr>aa>aa-sub-cntr
- Description** This command includes the total flow duration flow count in the AA subscriber's custom record.
The **no** form of the command excludes the total flow duration flow count.

total-flows-completed-count

- Syntax** [no] total-flows-completed-count
- Context** config>log>acct-policy>cr>aa>aa-sub-cntr
- Description** This command includes the total flows completed count in the AA subscriber's custom record.
The **no** form of the command excludes the total flow duration flow count.

from-aa-sub-counters

- Syntax** [no] from-aa-sub-counters
- Context** config>log>acct-policy>cr>aa
- Description** This command enables the context to configure Application Assurance “from subscriber” counter parameters.
The **no** form of the command excludes the “from subscriber” count.

all

- Syntax** all
- Context** config>log>acct-policy>cr>aa>aa-from-sub-cntr
config>log>acct-policy>cr>aa>aa-to-sub-cntr
- Default** This command include all counters.

flows-active-count

Syntax	[no] flows-active-count
Context	config>log>acct-policy>cr>aa>aa-from-sub-cntr config>log>acct-policy>cr>aa>aa-to-sub-cntr
Description	This command includes the active flow count. The no form of the command excludes the active flow count in the AA subscriber's custom record.
Default	no flows-active-count

flows-admitted-count

Syntax	[no] flows-admitted-count
Context	config>log>acct-policy>cr>aa>aa-from-sub-cntr config>log>acct-policy>cr>aa>aa-to-sub-cntr
Description	This command includes the admitted flow count. The no form of the command excludes the flow's admitted count in the AA subscriber's custom record.
Default	no flows-admitted-count

flows-denied-count

Syntax	[no] flows-denied-count
Context	config>log>acct-policy>cr>aa>aa-from-sub-cntr config>log>acct-policy>cr>aa>aa-to-sub-cntr
Description	This command includes the flow's denied count in the AA subscriber's custom record. The no form of the command excludes the flow's denied count.
Default	no flows-denied-count

forwarding-class

Syntax	[no] forwarding-class
Context	config>log>acct-policy>cr>aa>aa-from-sub-cntr config>log>acct-policy>cr>aa>aa-to-sub-cntr
Description	This command enables the collection of a Forwarding Class bitmap information added to the XML aa-sub and router level accounting records.

Default no forwarding-class

max-throughput-octet-count

Syntax [no] max-throughput-octet-count

Context config>log>acct-policy>cr>aa>aa-from-sub-cntr
config>log>acct-policy>cr>aa>aa-to-sub-cntr

Description This command includes the maximum throughput as measured in the octet count.
The **no** form of the command excludes the maximum throughput octet count.

max-throughput-packet-count

Syntax [no] max-throughput-packet-count

Context config>log>acct-policy>cr>aa>aa-from-sub-cntr
config>log>acct-policy>cr>aa>aa-to-sub-cntr

Description This command includes the maximum throughput as measured in the packet count.
The **no** form of the command excludes the maximum throughput packet count.

max-throughput-timestamp

Syntax [no] max-throughput-timestamp

Context config>log>acct-policy>cr>aa>aa-from-sub-cntr
config>log>acct-policy>cr>aa>aa-to-sub-cntr

Description This command includes the timestamp of the maximum throughput.
The **no** form of the command excludes the timestamp.

octets-admitted-count

Syntax [no] octets-admitted-count

Context config>log>acct-policy>cr>aa>aa-from-sub-cntr
config>log>acct-policy>cr>aa>aa-to-sub-cntr

Description This command includes the admitted octet count in the AA subscriber's custom record.
The **no** form of the command excludes the admitted octet count.

Default no octets-admitted-count

octets-denied-count

Syntax	[no] octets-denied-count
Context	config>log>acct-policy>cr>aa>aa-from-sub-cntr config>log>acct-policy>cr>aa>aa-to-sub-cntr
Description	This command includes the denied octet count in the AA subscriber's custom record. The no form of the command excludes the denied octet count.
Default	no octets-denied-count

packets-admitted-count

Syntax	[no] packets-admitted-count
Context	config>log>acct-policy>cr>aa>aa-from-sub-cntr config>log>acct-policy>cr>aa>aa-to-sub-cntr
Description	This command includes the admitted packet count in the AA subscriber's custom record. The no form of the command excludes the admitted packet count.
Default	no packets-admitted-count

packets-denied-count

Syntax	[no] packets-denied-count
Context	config>log>acct-policy>cr>aa>aa-from-sub-cntr config>log>acct-policy>cr>aa>aa-to-sub-cntr
Description	This command includes the denied packet count in the AA subscriber's custom record. The no form of the command excludes the denied packet count.
Default	no packets-denied-count

to-aa-sub-counters

Syntax	to-aa-sub-counters no to-aa-sub-counters
Context	config>log>acct-policy>cr>aa
Description	This command enables the context to configure Application Assurance “to subscriber” counter parameters. The no form of the command excludes the “to subscriber” count.

override-counter

Syntax	[no] override-counter <i>override-counter-id</i>
Context	config>log>acct-policy>cr
Description	This command enables the context to configure override counter (HSMDA) parameters. The no form of the command removes the ID from the configuration.
Parameters	<i>override-counter-id</i> — Specifies the override counter ID. Values 1 — 8

queue

Syntax	[no] queue <i>queue-id</i>
Context	config>log>acct-policy>cr
Description	This command specifies the queue-id for which counters will be collected in this custom record. The counters that will be collected are defined in egress and ingress counters. The no form of the command reverts to the default value.
Parameters	<i>queue-id</i> — Specifies the queue-id for which counters will be collected in this custom record.

e-counters

Syntax	[no] e-counters
Context	config>log>acct-policy>cr>override-cntr config>log>acct-policy>cr>queue config>log>acct-policy>cr>ref-override-cntr config>log>acct-policy>cr>ref-queue
Description	This command configures egress counter parameters for this custom record. The no form of the command reverts to the default value.

i-counters

Syntax	i-counters [all] no i-counters
Context	config>log>acct-policy>cr>override-cntr config>log>acct-policy>cr>ref-override-cntr config>log>acct-policy>cr>ref-queue
Description	This command configures ingress counter parameters for this custom record. The no form of the command
Parameters	all — Specifies all ingress counters should be included.

in-profile-octets-discarded-count

Syntax	[no] in-profile-octets-discarded-count
Context	config>log>acct-policy>cr>oc>e-count config>log>acct-policy>cr>roc>e-count config>log>acct-policy>cr>queue>e-count config>log>acct-policy>cr>ref-queue>e-count
Description	This command includes the in-profile octets discarded count. The no form of the command excludes the in-profile octets discarded count.

in-profile-octets-forwarded-count

Syntax	[no] in-profile-octets-forwarded-count
Context	config>log>acct-policy>cr>oc>e-count config>log>acct-policy>cr>roc>e-count config>log>acct-policy>cr>queue>e-count config>log>acct-policy>cr>ref-queue>e-count
Description	This command includes the in-profile octets forwarded count. The no form of the command excludes the in-profile octets forwarded count.

in-profile-packets-discarded-count

- Syntax** [no] in-profile-packets-discarded-count
- Context** config>log>acct-policy>cr>oc>e-count
config>log>acct-policy>cr>roc>e-count
config>log>acct-policy>cr>queue>e-count
config>log>acct-policy>cr>ref-queue>e-count
- Description** This command includes the in-profile packets discarded count.
The **no** form of the command excludes the in-profile packets discarded count.

in-profile-packets-forwarded-count

- Syntax** [no] in-profile-packets-forwarded-count
- Context** config>log>acct-policy>cr>oc>e-count
config>log>acct-policy>cr>roc>e-count
config>log>acct-policy>cr>queue>e-count
config>log>acct-policy>cr>ref-queue>e-count
- Description** This command includes the in-profile packets forwarded count.
The **no** form of the command excludes the in-profile packets forwarded count.

out-profile-octets-discarded-count

- Syntax** [no] out-profile-octets-discarded-count
- Context** config>log>acct-policy>cr>oc>e-count
config>log>acct-policy>cr>roc>e-count
config>log>acct-policy>cr>queue>e-count
config>log>acct-policy>cr>ref-queue>e-count
- Description** This command includes the out of profile packets discarded count.
The **no** form of the command excludes the out of profile packets discarded count.

out-profile-octets-forwarded-count

- Syntax** [no] out-profile-octets-forwarded-count
- Context** config>log>acct-policy>cr>oc>e-count
 config>log>acct-policy>cr>roc>e-count
 config>log>acct-policy>cr>queue>e-count
 config>log>acct-policy>cr>ref-queue>e-count
- Description** This command includes the out of profile octets forwarded count.
 The **no** form of the command excludes the out of profile octets forwarded count.

out-profile-packets-discarded-count

- Syntax** [no] out-profile-packets-discarded-count
- Context** config>log>acct-policy>cr>oc>e-count
 config>log>acct-policy>cr>roc>e-count
 config>log>acct-policy>cr>queue>e-count
 config>log>acct-policy>cr>ref-queue>e-count
- Description** This command includes the out of profile packets discarded count.
 The **no** form of the command excludes the out of profile packets discarded count.

out-profile-packets-forwarded-count

- Syntax** [no] out-profile-packets-forwarded-count
- Context** config>log>acct-policy>cr>oc>e-count
 config>log>acct-policy>cr>roc>e-count
 config>log>acct-policy>cr>queue>e-count
 config>log>acct-policy>cr>ref-queue>e-count
- Description** This command includes the out of profile packets forwarded count.
 The **no** form of the command excludes the out of profile packets forwarded count.

all-octets-offered-count

Syntax	[no] all-octets-offered-count
Context	config>log>acct-policy>cr>oc>i-count config>log>acct-policy>cr>roc>i-count config>log>acct-policy>cr>queue>i-count config>log>acct-policy>cr>ref-queue>i-count
Description	This command includes all octets offered in the count. The no form of the command excludes the octets offered in the count.
Default	no all-octets-offered-count

all-packets-offered-count

Syntax	[no] all-packets-offered-count
Context	config>log>acct-policy>cr>oc>i-count config>log>acct-policy>cr>roc>i-count config>log>acct-policy>cr>queue>i-count config>log>acct-policy>cr>ref-queue>i-count
Description	This command includes all packets offered in the count. The no form of the command excludes the packets offered in the count.
Default	no all-packets-offered-count

high-octets-discarded-count

Syntax	[no] high-octets-discarded-count
Context	config>log>acct-policy>cr>oc>i-count config>log>acct-policy>cr>roc>i-count config>log>acct-policy>cr>queue>i-count config>log>acct-policy>cr>ref-queue>i-count
Description	This command includes the high octets discarded count. The no form of the command excludes the high octets discarded count.
Default	no high-octets-discarded-count

high-octets-offered-count

Syntax	[no] high-octets-offered-count
Context	config>log>acct-policy>cr>oc>i-count config>log>acct-policy>cr>roc>i-count config>log>acct-policy>cr>queue>i-count config>log>acct-policy>cr>ref-queue>i-count
Description	This command includes the high octets offered count. The no form of the command excludes the high octets offered count.

high-packets-discarded-count

Syntax	[no] high-packets-discarded-count
Context	config>log>acct-policy>cr>oc>i-count config>log>acct-policy>cr>roc>i-count config>log>acct-policy>cr>queue>i-count config>log>acct-policy>cr>ref-queue>i-count
Description	This command includes the high packets discarded count. The no form of the command excludes the high packets discarded count.
Default	no high-packets-discarded-count

high-packets-offered-count

Syntax	[no] high-packets-offered-count
Context	config>log>acct-policy>cr>oc>i-count config>log>acct-policy>cr>roc>i-count config>log>acct-policy>cr>queue>i-count config>log>acct-policy>cr>ref-queue>i-count
Description	This command includes the high packets offered count. The no form of the command excludes the high packets offered count.
Default	no high-packets-offered -count

in-profile-octets-forwarded-count

Syntax	[no] in-profile-octets-forwarded-count
Context	config>log>acct-policy>cr>oc>i-count config>log>acct-policy>cr>roc>i-count config>log>acct-policy>cr>queue>i-count config>log>acct-policy>cr>ref-queue>i-count
Description	This command includes the in profile octets forwarded count. The no form of the command excludes the in profile octets forwarded count.
Default	no in-profile-octets-forwarded-count

in-profile-packets-forwarded-count

Syntax	[no] in-profile-packets-forwarded-count
Context	config>log>acct-policy>cr>oc>i-count config>log>acct-policy>cr>roc>i-count config>log>acct-policy>cr>queue>i-count config>log>acct-policy>cr>ref-queue>i-count
Description	This command includes the in profile packets forwarded count. The no form of the command excludes the in profile packets forwarded count.
Default	no in-profile-packets-forwarded-count

low-octets-discarded-count

Syntax	[no] low-octets-discarded-count
Context	config>log>acct-policy>cr>oc>i-count config>log>acct-policy>cr>roc>i-count config>log>acct-policy>cr>queue>i-count config>log>acct-policy>cr>ref-queue>i-count
Description	This command includes the low octets discarded count. The no form of the command excludes the low octets discarded count.
Default	no low-octets-discarded-count

low-packets-discarded-count

Syntax	[no] low-packets-discarded-count
Context	config>log>acct-policy>cr>oc>i-count config>log>acct-policy>cr>roc>i-count config>log>acct-policy>cr>queue>i-count config>log>acct-policy>cr>ref-queue>i-count
Description	This command includes the low packets discarded count. The no form of the command excludes the low packets discarded count.
Default	no low-packets-discarded-count

low-octets-offered-count

Syntax	[no] low-octets-offered-count
Context	config>log>acct-policy>cr>oc>i-count config>log>acct-policy>cr>roc>i-count config>log>acct-policy>cr>queue>i-count config>log>acct-policy>cr>ref-queue>i-count
Description	This command includes the low octets discarded count. The no form of the command excludes the low octets discarded count.

low-packets-offered-count

Syntax	[no] low-packets-offered-count
Context	config>log>acct-policy>cr>oc>i-count config>log>acct-policy>cr>roc>i-count config>log>acct-policy>cr>queue>i-count config>log>acct-policy>cr>ref-queue>i-count
Description	This command includes the low packets discarded count. The no form of the command excludes the low packets discarded count.

out-profile-octets-forwarded-count

Syntax	[no] out-profile-octets-forwarded-count
Context	config>log>acct-policy>cr>oc>i-count config>log>acct-policy>cr>roc>i-count config>log>acct-policy>cr>queue>i-count config>log>acct-policy>cr>ref-queue>i-count
Description	This command includes the out of profile octets forwarded count. The no form of the command excludes the out of profile octets forwarded count.
Default	no out-profile-octets-forwarded-count

out-profile-packets-forwarded-count

Syntax	[no] out-profile-packets-forwarded-count
Context	config>log>acct-policy>cr>oc>i-count config>log>acct-policy>cr>roc>i-count config>log>acct-policy>cr>queue>i-count config>log>acct-policy>cr>ref-queue>i-count
Description	This command includes the out of profile packets forwarded count. The no form of the command excludes the out of profile packets forwarded count.
Default	no out-profile-packets-forwarded-count

uncoloured-octets-offered-count

Syntax	[no] uncoloured-packets-offered-count
Context	config>log>acct-policy>cr>queue>i-count config>log>acct-policy>cr>ref-queue>i-count
Description	This command includes the uncoloured octets offered in the count. The no form of the command excludes the uncoloured octets offered in the count.

uncoloured-packets-offered-count

Syntax	[no] uncoloured-packets-offered-count
Context	config>log>acct-policy>cr>queue>i-count config>log>acct-policy>cr>ref-queue>i-count
Description	This command includes the uncolored packets offered count.

The **no** form of the command excludes the uncoloured packets offered count.

ref-aa-specific-counter

Syntax	ref-aa-specific-counter any no ref-aa-specific-counter
Context	config>log>acct-policy>cr
Description	This command enables the use of significant-change so only those aa-specific records which have changed in the last accounting interval are written. The no form of the command disables the use of significant-change so all aa-specific records are written whether or not they have changed within the last accounting interval.
Parameters	any — Indicates that a record is collected as long as any field records activity when non-zero significant-change value is configured.

ref-override-counter

Syntax	ref-override-counter <i>ref-override-counter-id</i> ref-override-counter all no ref-override-counter
Context	config>log>acct-policy>cr
Description	This command configures a reference override counter. The no form of the command reverts to the default value.
Default	no ref-override-counter

ref-queue

Syntax	ref-queue <i>queue-id</i> ref-queue all no ref-queue
Context	config>log>acct-policy>cr
Description	This command configures a reference queue. The no form of the command reverts to the default value.
Default	no ref-queue

significant-change

Syntax	significant-change <i>delta</i> no significant-change
Context	config>log>acct-policy>cr
Description	This command configures the significant change required to generate the record.
Parameters	<i>delta</i> — Specifies the delta change (significant change) that is required for the custom record to be written to the xml file. Values 0 — 4294967295 (For custom-record-aa-sub only values 0 or 1 are supported.)

Show Commands

accounting-policy

Syntax `accounting-policy [acct-policy-id] [access | network]`

Context show>log

Description This command displays accounting policy information.

Parameters *policy-id* — The policy ID that uniquely identifies the accounting policy, expressed as a decimal integer.

Values 1 — 99

access — Only displays access accounting policies.

network — Only displays network accounting policies.

Output **Accounting Policy Output** — The following table describes accounting policy output fields.

Table 44: Show Accounting Policy Output Fields

Label	Description
Policy ID	The identifying value assigned to a specific policy.
Type	Identifies accounting record type forwarded to the configured accounting file. access — Indicates that the policy is an access accounting policy. network — Indicates that the policy is a network accounting policy. none — Indicates no accounting record types assigned.
Def	Yes — Indicates that the policy is a default access or network policy. No — Indicates that the policy is not a default access or network policy.
Admin State	Displays the administrative state of the policy. Up — Indicates that the policy is administratively enabled. Down — Indicates that the policy is administratively disabled.
Oper State	Displays the operational state of the policy. Up — Indicates that the policy is operationally up. Down — Indicates that the policy is operationally down.

Table 44: Show Accounting Policy Output Fields (Continued)

Label	Description
Intvl	Displays the interval, in minutes, in which statistics are collected and written to their destination. The default depends on the record name type.
File ID	The log destination.
Record Name	The accounting record name which represents the configured record type.
This policy is applied to	Specifies the entity where the accounting policy is applied.

Sample Output

```
A:ALA-1# show log accounting-policy
=====
Accounting Policies
=====
Policy Type   Def Admin Oper  Intvl   File Record Name
Id           State State  State   Id
-----
1    network No  Up    Up    15     1    network-ingress-packets
2    network Yes Up    Up    15     2    network-ingress-octets
10   access  Yes Up    Up     5     3    complete-service-ingress-egress
=====
A:ALA-1#
```

```
A:ALA-1# show log accounting-policy 10
=====
Accounting Policies
=====
Policy Type   Def Admin Oper  Intvl   File Record Name
Id           State State  State   Id
-----
10   access  Yes Up    Up     5     3    complete-service-ingress-egress

Description : (Not Specified)

This policy is applied to:
  Svc Id: 100  SAP : 1/1/8:0    Collect-Stats
  Svc Id: 101  SAP : 1/1/8:1    Collect-Stats
  Svc Id: 102  SAP : 1/1/8:2    Collect-Stats
  Svc Id: 103  SAP : 1/1/8:3    Collect-Stats
  Svc Id: 104  SAP : 1/1/8:4    Collect-Stats
  Svc Id: 105  SAP : 1/1/8:5    Collect-Stats
  Svc Id: 106  SAP : 1/1/8:6    Collect-Stats
  Svc Id: 107  SAP : 1/1/8:7    Collect-Stats
  Svc Id: 108  SAP : 1/1/8:8    Collect-Stats
  Svc Id: 109  SAP : 1/1/8:9    Collect-Stats
...
=====
A:ALA-1#
```

```

A:ALA-1# show log accounting-policy network
=====
Accounting Policies
=====
Policy Type      Def Admin Oper  Intvl      File Record Name
Id              State State
-----
1      network No  Up   Up   15        1  network-ingress-packets
2      network Yes Up   Up   15        2  network-ingress-octets
=====
A:ALA-1#

A:ALA-1# show log accounting-policy access
=====
Accounting Policies
=====
Policy Type      Def Admin Oper  Intvl      File Record Name
Id              State State
-----
10     access Yes Up   Up   5         3  complete-service-ingress-egress
=====
A:ALA-1#

```

accounting-records

- Syntax** `accounting-records`
- Context** `show>log`
- Description** This command displays accounting policy record names.
- Output** **Accounting Records Output.** The following table describes accounting records output fields.

Table 45: Accounting Policy Output Fields

Label	Description
Record #	The record ID that uniquely identifies the accounting policy, expressed as a decimal integer.
Record Name	The accounting record name.
Def. Interval	The default interval, in minutes, in which statistics are collected and written to their destination.

Sample Output

NOTE: aa, video and subscriber records are not applicable to the 7950 XRS.

```

A:ALA-1# show log accounting-records
=====
Accounting Policy Records
=====

```

Show Commands

Record #	Record Name	Def. Interval
1	service-ingress-octets	5
2	service-egress-octets	5
3	service-ingress-packets	5
4	service-egress-packets	5
5	network-ingress-octets	15
6	network-egress-octets	15
7	network-ingress-packets	15
8	network-egress-packets	15
9	compact-service-ingress-octets	5
10	combined-service-ingress	5
11	combined-network-ing-egr-octets	15
12	combined-service-ing-egr-octets	5
13	complete-service-ingress-egress	5
14	combined-sdp-ingress-egress	5
15	complete-sdp-ingress-egress	5
16	complete-subscriber-ingress-egress	5
17	aa-protocol	15
18	aa-application	15
19	aa-app-group	15
20	aa-subscriber-protocol	15
21	aa-subscriber-application	15
22	aa-subscriber-app-group	15

=====
A:ALA-1#

applications

Syntax applications

Context show>log

Description This command displays a list of all application names that can be used in event-control and filter commands.

Output **Sample Output**

```
*A:7950 XRS-20# show log applications

=====
Log Event Application Names
=====
Application Name
-----
BGP
...
CHASSIS
...
IGMP
...
LDP
LI
...
MIRROR
...
MPLS
```

```

...
OSPF
PIM
...
PORT
...
SYSTEM
...
USER
...
VRTR
...
=====
A:ALA-1#

```

event-control

Syntax `event-control [application [event-name | event-number]]`

Context `show>log`

Description This command displays event control settings for events including whether the event is suppressed or generated and the severity level for the event.

If no options are specified all events, alarms and traps are listed.

Parameters **application** — Only displays event control for the specified application.

Default All applications.

Values bgp, cflowd, chassis, debug, igmp, lldp, mirror, ospf, pim, port, snmp, system, user, vrtr

event-name — Only displays event control for the named application event.

Default All events for the application.

event-number — Only displays event control for the specified application event number.

Default All events for the application.

Output **Show Event Control Output** — The following table describes the output fields for the event control.

Label	Description
Application	The application name.
ID#	The event ID number within the application. L ID# — An “L” in front of an ID represents event types that do not generate an associated SNMP notification. Most events do generate a notification, only the exceptions are marked with a preceding “L”.
Event Name	The event name.
P	CL — The event has a cleared severity/priority.

Label	Description (Continued)
	CR – The event has critical severity/priority.
	IN – The event has indeterminate severity/priority.
	MA – The event has major severity/priority.
	MI – The event has minor severity/priority.
	WA – The event has warning severity/priority.
g/s	gen – The event will be generated/logged by event control.
	sup – The event will be suppressed/dropped by event control.
	thr – Specifies that throttling is enabled.
Logged	The number of events logged/generated.
Dropped	The number of events dropped/suppressed.

Sample Output

```
A:gal171# show log event-control
=====
Log Events
=====
Application
ID#      Event Name                               P  g/s  Logged  Dropped
-----
BGP:
  2001  bgpEstablished                          MI  gen   0       0
  2002  bgpBackwardTransition                   WA  gen   0       0
  2003  tBgpMaxPrefix90                         WA  gen   0       0
  2004  tBgpMaxPrefix100                       CR  gen   0       0
L  2005  sendNotification                        WA  gen   0       0
L  2006  receiveNotification                     WA  gen   0       0
L  2007  bgpInterfaceDown                       WA  gen   0       0
L  2008  bgpConnNoKA                            WA  gen   0       0
L  2009  bgpConnNoOpenRcvd                      WA  gen   0       0
L  2010  bgpRejectConnBadLocAddr                 WA  gen   0       0
L  2011  bgpRemoteEndClosedConn                  WA  gen   0       0
L  2012  bgpPeerNotFound                         WA  gen   0       0
L  2013  bgpConnMgrTerminated                    WA  gen   0       0
L  2014  bgpTerminated                           WA  gen   0       0
L  2015  bgpNoMemoryPeer                         CR  gen   0       0
L  2016  bgpVariableRangeViolation               WA  gen   0       0
L  2017  bgpCfgViol                              WA  gen   0       0
CFLOWD:
  2001  cflowdCreated                           MI  gen   0       0
  2002  cflowdCreateFailure                     MA  gen   0       0
  2003  cflowdDeleted                           MI  gen   0       0
  2004  cflowdStateChanged                      MI  gen   0       0
  2005  cflowdCleared                           MI  gen   0       0
  2006  cflowdFlowCreateFailure                 MI  gen   0       0
  2007  cflowdFlowFlushFailure                  MI  gen   0       0
  2008  cflowdFlowUnsuppProto                   MI  sup   0       0
CCAG:
```



```

...
CHASSIS:
    2001 cardFailure                MA gen      0      0
    2002 cardInserted              MI gen      4      0
    2003 cardRemoved               MI gen      0      0
    2004 cardWrong                 MI gen      0      0
    2005 EnvTemperatureTooHigh     MA gen      0      0
...
DEBUG:
L 2001 traceEvent                 MI gen      0      0
DOT1X:
FILTER:
    2001 filterPBRPacketsDropped  MI gen      0      0
IGMP:
    2001 vRtrIcmpIfRxQueryVerMismatch WA gen      0      0
    2002 vRtrIcmpIfCModeRxQueryMismatch WA gen      0      0
IGMP_SNOOPING:
IP:
L 2001 clearRTMError              MI gen      0      0
L 2002 ipEtherBroadcast           MI gen      0      0
L 2003 ipDuplicateAddress         MI gen      0      0
L 2004 ipArpInfoOverwritten      MI gen      0      0
L 2005 fibAddFailed              MA gen      0      0
L 2006 qosNetworkPolicyMallocFailed MA gen      0      0
L 2007 ipArpBadInterface         MI gen      0      0
L 2008 ipArpDuplicateIpAddress    MI gen      0      0
L 2009 ipArpDuplicateMacAddress   MI gen      0      0
ISIS:
    2001 vRtrIsisDatabaseOverload  WA gen      0      0
    2002 vRtrIsisManualAddressDrops WA gen      0      0
    2003 vRtrIsisCorruptedLSPDetected WA gen      0      0
    2004 vRtrIsisMaxSeqExceedAttempt WA gen      0      0
    2005 vRtrIsisIDLenMismatch     WA gen      0      0
    2006 vRtrIsisMaxAreaAdrrsMismatch WA gen      0      0
....
USER:
L 2001 cli_user_login             MI gen      2      0
L 2002 cli_user_logout           MI gen      1      0
L 2003 cli_user_login_failed     MI gen      0      0
L 2004 cli_user_login_max_attempts MI gen      0      0
L 2005 ftp_user_login            MI gen      0      0
L 2006 ftp_user_logout           MI gen      0      0
L 2007 ftp_user_login_failed     MI gen      0      0
L 2008 ftp_user_login_max_attempts MI gen      0      0
L 2009 cli_user_io               MI sup      0      48
L 2010 snmp_user_set             MI sup      0      0
L 2011 cli_config_io             MI gen     4357      0
VRRP:
    2001 vrrpTrapNewMaster         MI gen      0      0
    2002 vrrpTrapAuthFailure       MI gen      0      0
    2003 tmnxVrrpIPListMismatch    MI gen      0      0
    2004 tmnxVrrpIPListMismatchClear MI gen      0      0
    2005 tmnxVrrpMultipleOwners    MI gen      0      0
    2006 tmnxVrrpBecameBackup      MI gen      0      0
L 2007 vrrpPacketDiscarded       MI gen      0      0
VRTR:
    2001 tmnxVRtrMidRouteTCA       MI gen      0      0
    2002 tmnxVRtrHighRouteTCA     MI gen      0      0
    2003 tmnxVRtrHighRouteCleared  MI gen      0      0

```

Show Commands

```

2004 tmnxVRtrIllegalLabelTCA          MA gen          0          0
2005 tmnxVRtrMcastMidRouteTCA        MI gen          0          0
2006 tmnxVRtrMcastMaxRoutesTCA       MI gen          0          0
2007 tmnxVRtrMcastMaxRoutesCleared   MI gen          0          0
2008 tmnxVRtrMaxArpEntriesTCA        MA gen          0          0
2009 tmnxVRtrMaxArpEntriesCleared     MI gen          0          0
2011 tmnxVRtrMaxRoutes                MI gen          0          0
=====
A:ALA-1#

```

```
A:ALA-1# show log event-control ospf
```

```

=====
Log Events
=====
Application
ID#      Event Name                               P   g/s    Logged    Dropped
-----
2001 ospfVirtIfStateChange                 WA gen          0          0
2002 ospfNbrStateChange                   WA gen          1          0
2003 ospfVirtNbrStateChange               WA gen          0          0
2004 ospfIfConfigError                    WA gen          0          0
2005 ospfVirtIfConfigError                 WA gen          0          0
2006 ospfIfAuthFailure                    WA gen          0          0
2007 ospfVirtIfAuthFailure                WA gen          0          0
2008 ospfIfRxBadPacket                    WA gen          0          0
2009 ospfVirtIfRxBadPacket                WA gen          0          0
2010 ospfTxRetransmit                      WA sup         0          0
2011 ospfVirtIfTxRetransmit                WA sup         0          0
2012 ospfOriginateLsa                      WA sup         0          404
2013 ospfMaxAgeLsa                         WA gen          3          0
2014 ospfLsdbOverflow                      WA gen          0          0
2015 ospfLsdbApproachingOverflow           WA gen          0          0
2016 ospfIfStateChange                     WA gen          2          0
2017 ospfNssaTranslatorStatusChange        WA gen          0          0
2018 vRtrOspfSpfRunsStopped                WA gen          0          0
2019 vRtrOspfSpfRunsRestarted              WA gen          0          0
2020 vRtrOspfOverloadEntered                WA gen          1          0
2021 vRtrOspfOverloadExited                WA gen          0          0
2022 ospfRestartStatusChange               WA gen          0          0
2023 ospfNbrRestartHelperStatusChange      WA gen          0          0
2024 ospfVirtNbrRestartHelperStsChg        WA gen          0          0
=====
A:ALA-1#

```

```
A:ALA-1# show log event-control ospf ospfVirtIfStateChange
```

```

=====
Log Events
=====
Application
ID#      Event Name                               P   g/s    Logged    Dropped
-----
2001 ospfVirtIfStateChange                 WA gen          0          0
=====
A:ALA-1#

```

file-id

Syntax `file-id [log-file-id]`

Context `show>log`

Description This command displays event file log information.
If no command line parameters are specified, a summary output of all event log files is displayed.
Specifying a file ID displays detailed information on the event file log.

Parameters *log-file-id* — Displays detailed information on the specified event file log.

Output **Log File Output** — The following table describes the output fields for a log file summary.

Label	Description
file-id	The log file ID.
rollover	The rollover time for the log file which is how long in between partitioning of the file into a new file.
retention	The retention time for the file in the system which is how long the file should be retained in the file system.
admin location	The primary flash device specified for the file location. none — indicates no specific flash device was specified.
backup location	The secondary flash device specified for the file location if the admin location is not available. none — Indicates that no backup flash device was specified.
oper location	The actual flash device on which the log file exists.
file-id	The log file ID.
rollover	The rollover time for the log file which is how long in between partitioning of the file into a new file.
retention	The retention time for the file in the system which is how long the file should be retained in the file system.
file name	The complete pathname of the file associated with the log ID.
expired	Indicates whether or not the retention period for this file has passed.
state	in progress — Indicates the current open log file. complete — Indicates the old log file.

Sample Output

```
A:ALA-1# show log file-id
=====
File Id List
=====
file-id  rollover  retention  admin      backup      oper
         location  location  location  location  location
-----
1         60         4         cf1:      cf2:      cf1:
2         60         3         cf1:      cf3:      cf1:
3         1440      12        cf1:      none      cf1:
10        1440      12        cf1:      none      none
11        1440      12        cf1:      none      none
15        1440      12        cf1:      none      none
20        1440      12        cf1:      none      none
=====
A:ALA-1#
```

```
A:ALA-1# show log file-id 10
=====
File Id List
=====
file-id  rollover  retention  admin      backup      oper
         location  location  location  location  location
-----
10  1440      12        cf3:      cf2:      cf1:
Description : Main
=====
File Id 10 Location cf1:
=====
file name                               expired  state
-----
cf1:\log\log0302-20060501-012205        yes     complete
cf1:\log\log0302-20060501-014049        yes     complete
cf1:\log\log0302-20060501-015344        yes     complete
cf1:\log\log0302-20060501-015547        yes     in progress
=====
A:ALA-1#
```

filter-id

- Syntax** **filter-id** [*filter-id*]
- Context** show>log
- Description** This command displays event log filter policy information.
- Parameters** *filter-id* — Displays detailed information on the specified event filter policy ID.

Output **Event Log Filter Summary Output** — The following table describes the output fields for event log filter summary information.

Table 46: Event Log Filter Summary Output Fields

Label	Description
Filter Id	The event log filter ID.
Applied	no. The event log filter is not currently in use by a log ID. yes. The event log filter is currently in use by a log ID.
Default Action	drop. The default action for the event log filter is to drop events not matching filter entries. forward. The default action for the event log filter is to forward events not matching filter entries.
Description	The description string for the filter ID.

Sample Output

```
*A:ALA-48>config>log# show log filter-id
=====
Log Filters
=====
Filter Applied Default Description
Id           Action
-----
1           no       forward
5           no       forward
10          no       forward
1001        yes      drop    Collect events for Serious Errors Log
=====
*A:ALA-48>config>log#
```

Event Log Filter Detailed Output — The following table describes the output fields for detailed event log filter information .

Table 47: Event Log Filter Detail Output Fields

Label	Description
Filter-id	The event log filter ID.
Applied	no — The event log filter is not currently in use by a log ID. yes — The event log filter is currently in use by a log ID.

Table 47: Event Log Filter Detail Output Fields (Continued)

Label	Description
Default Action	<p><code>drop</code> – The default action for the event log filter is to drop events not matching filter entries.</p> <p><code>forward</code> – The default action for the event log filter is to forward events not matching filter entries.</p>
Description (Filter-id)	The description string for the filter ID.

Table 48: Log Filter Match Criteria Output Fields

Label	Description
Entry-id	The event log filter entry ID.
Action	<p><code>default</code> – There is no explicit action for the event log filter entry and the filter’s default action is used on matching events.</p> <p><code>drop</code> – The action for the event log filter entry is to drop matching events.</p> <p><code>forward</code> – The action for the event log filter entry is to forward matching events.</p>
Description (Entry-id)	The description string for the event log filter entry.
Application	The event log filter entry application match criterion.
Event Number	The event log filter entry application event ID match criterion.
Severity	<p><code>cleared</code> – The log event filter entry application event severity cleared match criterion.</p> <p><code>indeterminate</code> – The log event filter entry application event severity indeterminate match criterion.</p> <p><code>critical</code> – The log event filter entry application event severity critical match criterion.</p> <p><code>major</code> – The log event filter entry application event severity cleared match criterion.</p> <p><code>minor</code> – The log event filter entry application event severity minor match criterion.</p> <p><code>warning</code> – The log event filter entry application event severity warning match criterion.</p>

Table 48: Log Filter Match Criteria Output Fields (Continued)

Label	Description
Subject	Displays the event log filter entry application event ID subject string match criterion.
Router	Displays the event log filter entry application event ID router <i>router-instance</i> string match criterion.
Operator	<p>There is an operator field for each match criteria: application, event number, severity, and subject.</p> <p>equal – Matches when equal to the match criterion.</p> <p>greaterThan – Matches when greater than the match criterion.</p> <p>greaterThanOrEqualTo – Matches when greater than or equal to the match criterion.</p> <p>lessThan – Matches when less than the match criterion.</p> <p>lessThanOrEqualTo – Matches when less than or equal to the match criterion.</p> <p>notEqual – Matches when not equal to the match criterion.</p> <p>off – No operator specified for the match criterion.</p>

Sample Output

```

*A:ALA-48>config>log# show log filter-id 1001
=====
Log Filter
=====
Filter-id      : 1001      Applied      : yes      Default Action: drop
Description    : Collect events for Serious Errors Log
-----
Log Filter Match Criteria
-----
Entry-id      : 10              Action       : forward
Application    :                  Operator     : off
Event Number  : 0              Operator     : off
Severity      : major          Operator     : greaterThanOrEqualTo
Subject       :                  Operator     : off
Match Type    : exact string           :
Router        :                  Operator     : off
Match Type    : exact string           :
Description   : Collect only events of major severity or higher
-----
*A:ALA-48>config>log#

```

log-collector

- Syntax** `log-collector`
- Context** `show>log`
- Description** Show log collector statistics for the main, security, change and debug log collectors.
- Output** **Log-Collector Output** — The following table describes log-collector output fields.

Table 49: Show Log-Collector Output Fields

Label	Description
<code><Collector Name></code>	<p>Main — The main event stream contains the events that are not explicitly directed to any other event stream.</p> <p>Security — The security stream contains all events that affect attempts to breach system security such as failed login attempts, attempts to access MIB tables to which the user is not granted access or attempts to enter a branch of the CLI to which access has not been granted.</p> <p>Change — The change event stream contains all events that directly affect the configuration or operation of this node.</p> <p>Debug — The debug-trace stream contains all messages in the debug stream.</p>
<code>Dest. Log ID</code>	Specifies the event log stream destination.
<code>Filter ID</code>	The value is the index to the entry which defines the filter to be applied to this log's source event stream to limit the events output to this log's destination. If the value is 0, then all events in the source log are forwarded to the destination.
<code>Status</code>	<p>Enabled — Logging is enabled.</p> <p>Disabled — Logging is disabled.</p>
<code>Dest. Type</code>	<p>Console — A log created with the console type destination displays events to the physical console device.</p> <p>Events are displayed to the console screen whether a user is logged in to the console or not.</p> <p>A user logged in to the console device or connected to the CLI via a remote telnet or SSH session can also create a log with a destination type of 'session'. Events are displayed to the session device until the user logs off. When the user logs off, the 'session' type log is deleted.</p> <p>Syslog — All selected log events are sent to the syslog address.</p> <p>SNMP traps — Events defined as SNMP traps are sent to the configured SNMP trap destinations and are logged in NOTIFICATION-LOG-MIB tables.</p>

Table 49: Show Log-Collector Output Fields (Continued)

Label	Description
File	All selected log events will be directed to a file on one of the CPM's compact flash disks.
Memory	All selected log events will be directed to an in-memory storage area.

Sample Output

```
A:ALA-1# show log log-collector
=====
Log Collectors
=====
Main          Logged   : 1224          Dropped   : 0
  Dest Log Id: 99   Filter Id: 0      Status: enabled  Dest Type: memory
  Dest Log Id: 100 Filter Id: 1001  Status: enabled  Dest Type: memory

Security      Logged   : 3          Dropped   : 0

Change        Logged   : 3896         Dropped   : 0

Debug         Logged   : 0          Dropped   : 0

=====
A:ALA-1#
```

log-id

Syntax	log-id [<i>log-id</i>] [severity <i>severity-level</i>] [application <i>application</i>] [sequence <i>from-seq</i> [<i>to-seq</i>]] [count <i>count</i>] [router <i>router-instance</i> [expression]] [subject <i>subject</i> [regexp]] [ascending descending]
Context	show>log
Description	<p>This command displays an event log summary with settings and statistics or the contents of a specific log file, SNMP log, or memory log.</p> <p>If the command is specified with no command line options, a summary of the defined system logs is displayed. The summary includes log settings and statistics.</p> <p>If the log ID of a memory, SNMP, or file event log is specified, the command displays the contents of the log. Additional command line options control what and how the contents are displayed.</p> <p>Contents of logs with console, session or syslog destinations cannot be displayed. The actual events can only be viewed on the receiving syslog or console device.</p>
Parameters	<p><i>log-id</i> — Displays the contents of the specified file log or memory log ID. The log ID must have a destination of an SNMP or file log or a memory log for this parameter to be used.</p> <p>Default Displays the event log summary</p> <p>Values 1 — 99</p> <p>severity <i>severity-level</i> — Displays only events with the specified and higher severity.</p> <p>Default All severity levels</p> <p>Values cleared, indeterminate, critical, major, minor, warning</p> <p>application <i>application</i> — Displays only events generated by the specified application.</p> <p>Default All applications</p> <p>Values bgp, cflowd, chassis, debug, igmp, lldp, mirror, ospf, pim, port, snmp, system, user, vtr</p> <p>expression — Specifies to use a regular expression as match criteria for the router instance string.</p> <p>sequence <i>from-seq</i> [<i>to-seq</i>] — Displays the log entry numbers from a particular entry sequence number (<i>from-seq</i>) to another sequence number (<i>to-seq</i>). The <i>to-seq</i> value must be larger than the <i>from-seq</i> value.</p> <p>If the <i>to-seq</i> number is not provided, the log contents to the end of the log is displayed unless the count parameter is present in which case the number of entries displayed is limited by the count.</p> <p>Default All sequence numbers</p> <p>Values 1 — 4294967295</p> <p>count <i>count</i> — Limits the number of log entries displayed to the <i>number</i> specified.</p> <p>Default All log entries</p> <p>Values 1 — 4294967295</p>

router-instance — Specifies a router name up to 32 characters to be used in the display criteria.

subject *subject* — Displays only log entries matching the specified text *subject* string. The subject is the object affected by the event, for example the port-id would be the subject for a link-up or link-down event.

regexp — Specifies to use a regular expression as parameters with the specified *subject* string..

ascending / descending — Specifies sort direction. Logs are normally shown from the newest entry to the oldest in **descending** sequence number order on the screen. When using the **ascending** parameter, the log will be shown from the oldest to the newest entry.

Default Descending

Output **Show Log-ID Output** — The following table describes the log ID field output.

Label	Description
Log Id	An event log destination.
Source	no — The event log filter is not currently in use by a log ID. yes — The event log filter is currently in use by a log ID.
Filter ID	The value is the index to the entry which defines the filter to be applied to this log's source event stream to limit the events output to this log's destination. If the value is 0, then all events in the source log are forwarded to the destination.
Admin State	Up — Indicates that the administrative state is up. Down — Indicates that the administrative state is down.
Oper State	Up — Indicates that the operational state is up. Down — Indicates that the operational state is down.
Logged	The number of events that have been sent to the log source(s) that were forwarded to the log destination.
Dropped	The number of events that have been sent to the log source(s) that were not forwarded to the log destination because they were filtered out by the log filter.
Dest. Type	Console — All selected log events are directed to the system console. If the console is not connected, then all entries are dropped. Syslog — All selected log events are sent to the syslog address. SNMP traps — Events defined as SNMP traps are sent to the configured SNMP trap destinations and are logged in NOTIFICATION-LOG-MIB tables. File — All selected log events will be directed to a file on one of the CPM's compact flash disks.

Label	Description (Continued)
	Memory — All selected log events will be directed to an in-memory storage area.
Dest ID	The event log stream destination.
Size	The allocated memory size for the log.
Time format	The time format specifies the type of timestamp format for events sent to logs where log ID destination is either syslog or file. When the time format is UTC, timestamps are written using the Coordinated Universal Time value. When the time format is local, timestamps are written in the system's local time.

Sample Output

```
A:ALA-1# show log log-id
=====
Event Logs
=====
Log Source      Filter Admin Oper  Logged  Dropped Dest      Dest  Size
Id              Id      State State                Type      Id
-----
1  none         none   up   down  52      0      file      10    N/A
2  C            none   up   up    41      0      syslog    1     N/A
99 M           none   up   up    2135   0      memory    500
=====
A:ALA-1#
```

Sample Memory or File Event Log Contents Output

```
A:gall171# show log log-id 99
=====
Event Log 99
=====
Description : Default System Log
Memory Log contents [size=500  next event=70  (not wrapped)]

69 2007/01/25 18:20:40.00 UTC CRITICAL: SYSTEM #2029 Base Redundancy
"The active CPM card A is operating in singleton mode.  There is no standby CPM
card."

68 2007/01/25 17:48:38.16 UTC WARNING: SYSTEM #2006 Base LOGGER
"New event throttle interval 10, configuration modified"

67 2007/01/25 00:34:53.97 UTC CRITICAL: SYSTEM #2029 Base Redundancy
"The active CPM card A is operating in singleton mode.  There is no standby CPM
card."

66 2007/01/24 22:59:22.00 UTC CRITICAL: SYSTEM #2029 Base Redundancy
```

```

"The active CPM card A is operating in singleton mode.  There is no standby CPM card."

65 2007/01/24 02:08:47.92 UTC CRITICAL: SYSTEM #2029 Base Redundancy
"The active CPM card A is operating in singleton mode.  There is no standby CPM card."
...
=====
A:gal171

A:NS061550532>config>log>snmp-trap-group# show log log-id 1
=====
Event Log 1
=====
SNMP Log contents [size=100  next event=3  (not wrapped)]
Cannot send to SNMP target address 10.1.1.1.
Waiting to replay starting from event #2

14 2000/01/05 00:54:09.11 UTC WARNING: MPLS #2007 Base VR 1:
"Instance is in administrative state: inService, operational state: inService"

13 2000/01/05 00:54:09.11 UTC WARNING: MPLS #2008 Base VR 1:
"Interface linkToIxia is in administrative state: inService, operational state:
inService"
....
=====
A:NS061550532>config>log>snmp-trap-group#

```

snmp-trap-group

- Syntax** `snmp-trap-group [log-id]`
- Context** `show>log`
- Description** This command displays SNMP trap group configuration information.
- Parameters** *log-id* — Displays only SNMP trap group information for the specified trap group log ID.
- Values** 1 — 99
- Output** **SNMP Trap Group Output** — The following table describes SNMP trap group output fields.

Table 50: SNMP Trap Group Output Fields

Label	Description
Log-ID	The log destination ID for an event stream.
Address	The IP address of the trap receiver,
Port	The destination UDP port used for sending traps to the destination, expressed as a decimal integer.
Version	Specifies the SNMP version format to use for traps sent to the trap receiver. Valid values are snmpv1, snmpv2c, snmpv3.

Table 50: SNMP Trap Group Output Fields (Continued)

Label	Description
Community	The community string required by snmpv1 or snmpv2c trap receivers.
Security-Level	The required authentication and privacy levels required to access the views on this node.
Replay	Indicates whether or not the replay parameter has been configured, enabled or disabled, for the trap-target address.
Replay from	Indicates the sequence ID of the first missed notification that will be replayed when a route is added to the routing table by which trap-target address can be reached. If no notifications are waiting to be replayed this field shows n/a.
Last Replay	Indicates the last time missed events were replayed to the trap-target address. If no events have ever been replayed this field shows never.

Sample Output

```
A:SetupCLI>config>log>snmp-trap-group# show log snmp-trap-group 44
=====
SNMP Trap Group 44
=====
Description : none
-----
Name       : ntt-test
Address    : 10.10.10.3
Port       : 162
Version    : v2c
Community  : ntttesting
Sec. Level : none
Replay     : disabled
Replay from : n/a
Last replay : never
-----
Name       : test2
Address    : 20.20.20.5
Port       : 162
Version    : v2c
Community  : ntttesting
Sec. Level : none
Replay     : disabled
Replay from : n/a
Last replay : never
=====
A:SetupCLI>config>log>snmp-trap-group#
```

syslog

- Syntax** `syslog [syslog-id]`
- Context** `show>log`
- Description** This command displays syslog event log destination summary information or detailed information on a specific syslog destination.
- Parameters** *syslog-id* — Displays detailed information on the specified syslog event log destination.

Values 1 — 10

- Output** **Syslog Event Log Destination Summary Output** — The following table describes the syslog output fields.

Table 51: Show Log Syslog Output Fields

Label	Description
Syslog ID	The syslog ID number for the syslog destination.
IP Address	The IP address of the syslog target host.
Port	The configured UDP port number used when sending syslog messages.
Facility	The facility code for messages sent to the syslog target host.
Severity Level	The syslog message severity level threshold.
Below Level Dropped	A count of messages not sent to the syslog collector target because the severity level of the message was above the configured severity. The higher the level, the lower the severity.
Prefix Present	Yes — A log prefix was prepended to the syslog message sent to the syslog host. No — A log prefix was not prepended to the syslog message sent to the syslog host.
Description	A text description stored in the configuration file for a configuration context.
LogPrefix	The prefix string prepended to the syslog message.
Log-id	Events are directed to this destination.

Sample Output

```
*A:ALA-48>config>log# show log syslog
=====
Syslog Target Hosts
=====
Id      Ip Address          Port      Sev Level
      Below Level Drop          Facility  Pfx Level
```

Show Commands

```
-----  
2      unknown                               514      info  
      0                                     local7   yes  
3      unknown                               514      info  
      0                                     local7   yes  
5      unknown                               514      info  
      0                                     local7   yes  
10     unknown                               514      info  
      0                                     local7   yes  
=====
```

*A:ALA-48>config>log#

```
*A:MV-SR>config>log# show log syslog 1  
=====
```

Syslog Target 1

```
=====
```

IP Address	: 192.168.15.22
Port	: 514
Log-ids	: none
Prefix	: Sr12
Facility	: local1
Severity Level	: info
Prefix Level	: yes
Below Level Drop	: 0
Description	: Linux Station Springsteen

```
=====
```

*A:MV-SR>config>log#

Clear Commands

log

Syntax	log <i>log-id</i>
Context	clear
Description	<p>Reinitializes/rolls over the specified memory/file event log ID. Memory logs are reinitialized and cleared of contents. File logs are manually rolled over by this command.</p> <p>This command is only applicable to event logs that are directed to file destinations and memory destinations.</p> <p>SNMP, syslog and console/session logs are not affected by this command.</p>
Parameters	<i>log-id</i> . The event log ID to be initialized/rolled over.
	Values 1 — 100

Clear Commands

Facility Alarms

In This Chapter

This chapter provides information about configuring event and accounting logs in the system.

Topics in this chapter include:

- [Facility Alarms Overview on page 500](#)
- [Facility Alarms vs. Log Events on page 501](#)
- [Facility Alarm Severities and Alarm LED Behavior on page 503](#)
- [Facility Alarm Hierarchy on page 504](#)
- [Facility Alarm Hierarchy on page 504](#)

Facility Alarms Overview

Facility Alarms provide a useful tool for operators to easily track and display the basic status of their equipment facilities.

CLI display (show routines) allows the system operator to easily identify current facility alarm conditions and recently cleared alarms without searching event logs or monitoring various card and port show commands to determine the health of managed objects in the system such as cards and ports.

The SR-OS alarm model is based on RFC 3877, *Alarm Management Information Base (MIB)*, (which evolved from the IETF DISMAN drafts).

Facility Alarms vs. Log Events

Facility Alarms are different than (log) events. Events are a single point in time and are generally stateless. Facility Alarms have a state (at least two states: active and clear) and duration and can be modelled with state transition events (raised, cleared).

The Facility Alarms module processes log events in order to generate the raised and cleared state for the alarms. If a raising log event is suppressed under event-control, then the associated Alarm will not be raised. If a clearing log event is suppressed under event-control, then it is still processed for the purpose of clearing the associated alarm. Log event filtering, throttling and discarding of events during overload do not affect Facility Alarm processing. Log events are processed by the Facility Alarm module before they are discarded in all cases.

Figure 9 illustrates the relationship of log events, alarms and the LEDs.

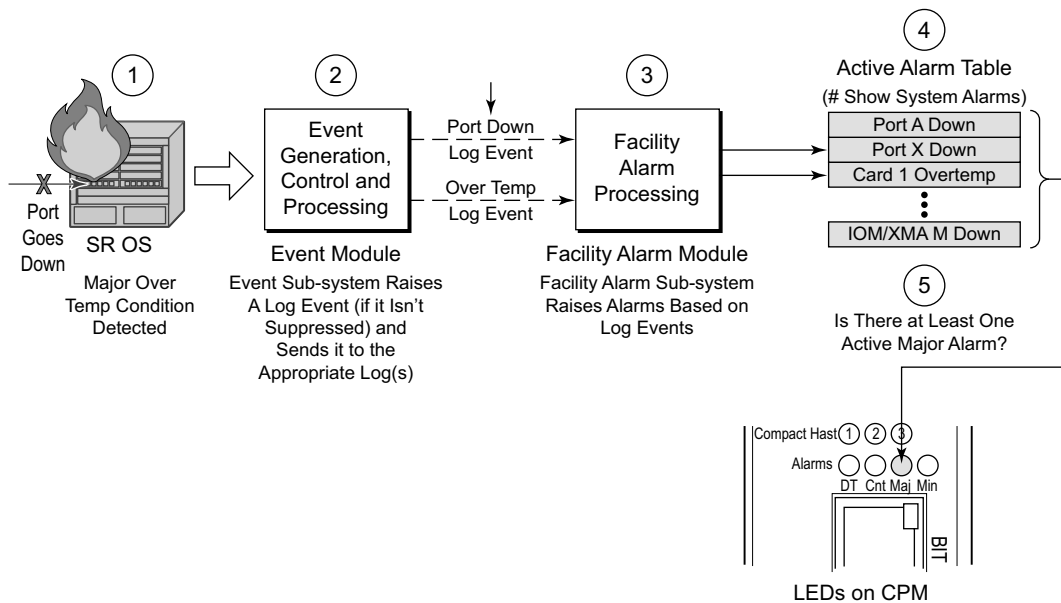

OSSG651

Figure 9: Log Events, Alarms and LEDs

Facility Alarms are different and independent functionality from other uses of the term *alarm* in SR-OS such as:

- Log events that use the term **alarm** (tmnxEqPortSonetAlarm)
- **configure card fp hi-bw-mcast-src [alarm]**
- **configure mcast-management multicast-info-policy bundle channel source-override video analyzer alarms**
- **configure port ethernet report-alarm**
- **configure system thresholds no memory-use-alarm**
- **configure system thresholds rmon no alarm**
- **configure system security cpu-protection policy alarm**

Facility Alarm Severities and Alarm LED Behavior

The Alarm LEDs on the CPM/CCM reflects the current status of the Facility Alarms:

- The Critical Alarm LED is lit if there is 1 or more active Critical Facility Alarms
- Similarly with the Major and Minor alarm LEDs
- The OT Alarm LED is not controlled by the Facility Alarm module

The supported alarm severities are as follows:

- Critical (with an associated LED on the CPM/CCM)
- Major (with an associated LED on the CPM/CCM)
- Minor (with an associated LED on the CPM/CCM)
- Warning (no LED)

Alarms inherit their severity from the raising event.

Log events that are a raising event for a facility alarm configured with a severity of *indeterminate* or *cleared* will result in those alarms not being raised (but clearing events are processed in order to clear alarms regardless of the severity of the clearing event).

Changing the severity of a raising event only affects subsequent occurrences of that event and alarms. Alarms that are already raised when their raising event severity is changed maintain their original severity.

Facility Alarm Hierarchy

Facility Alarms for *children* objects is not raised for failure of a *parent* object. For example, when an MDA fails (or is *shutdown*) there is not a set of port alarms raised.

When a parent alarm is cleared, children alarms that are still in occurrence on the node appears in the active alarms list. For example, when a port fails there is a port alarm, but if the MDA is later shutdown the port alarm is cleared (and a card alarm will be active for the MDA). If the MDA comes back into service, and the port is still down, then a port alarm becomes active once again.

The supported Facility Alarm hierarchy is as follows (parent objects that are *down* cause alarms in all children to be masked):

- CPM -> Compact Flash
- CCM -> Compact Flash
- IOM/IMM -> MDA -> Port -> Channel
- XCM -> XMA -> Port
- MCM -> MDA -> Port -> Channel

Note that a *masked* alarm is not the same as a *cleared* alarm. The cleared alarm queue does not display entries for previously raised alarms that are currently masked. If the masking event goes away, then the previously raised alarms will once again be visible in the active alarm queue.

Facility Alarm List

The following table(s) show the supported Facility Alarms.

Table 52: Alarm, Alarm Name/Raising Event, Sample Details String and Clearing Event

Alarm *1	Alarm Name/Raising Event	Sample Details String	Clearing Event
7-2001-1	tmnxEqCardFailure	Class MDA Module: failed, reason: Mda 1 failed startup tests	tmnxChassisNotification Clear
7-2003-1	tmnxEqCardRemoved	Class CPM Module: removed	tmnxEqCardInserted
7-2004-1	tmnxEqWrongCard	Class IOM Module: wrong type inserted	tmnxChassisNotification Clear
7-2005-1	tmnxEnvTempTooHigh	Chassis 1: temperature too high	tmnxChassisNotification Clear
7-2006-1	tmnxEqFanFailure	Fan 2 failed	tmnxChassisNotification Clear
7-2007-1	tmnxEqPowerSupplyFailureOvt	Power supply 2 over temperature	tmnxChassisNotification Clear
7-2008-1	tmnxEqPowerSupplyFailureAc	Power supply 1 AC failure	tmnxChassisNotification Clear
7-2009-1	tmnxEqPowerSupplyFailureDc	Power supply 2 DC failure	tmnxChassisNotification Clear
7-2011-1	tmnxEqPowerSupplyRemoved	Power supply 1, power lost	tmnxEqPowerSupplyInserted
7-2017-1	tmnxEqSyncIfTimingHoldover	Synchronous Timing interface in holdover state	tmnxEqSyncIfTimingHoldoverClear
7-2019-1	tmnxEqSyncIfTimingRef1Alarm with attribute tmnxSyncIfTimingNotifyAlarm == 'los(1)'	Synchronous Timing interface, alarm los on reference 1	tmnxEqSyncIfTimingRef1AlarmClear
7-2019-2	tmnxEqSyncIfTimingRef1Alarm with attribute tmnxSyncIfTimingNotifyAlarm == 'oof(2)'	Synchronous Timing interface, alarm oof on reference 1	same as 7-2019-1
7-2019-3	tmnxEqSyncIfTimingRef1Alarm with attribute tmnxSyncIfTimingNotifyAlarm == 'oopir(3)'	Synchronous Timing interface, alarm oopir on reference 1	same as 7-2019-1
7-2021-x	same as 7-2019-x but for ref2	same as 7-2019-x but for ref2	same as 7-2019-x but for ref2
7-2030-x	same as 7-2019-x but for the BITS input	same as 7-2019-x but for the BITS input	same as 7-2019-x but for the BITS input
7-2033-1	tmnxChassisUpgradeInProgress	Class CPM Module: software upgrade in progress	tmnxChassisUpgradeComplete

Table 52: Alarm, Alarm Name/Raising Event, Sample Details String and Clearing Event (Continued)

Alarm *1	Alarm Name/Raising Event	Sample Details String	Clearing Event
7-2050-1	tmnxEqPowerSupplyFailureInput	Power supply 1 input failure	tmnxChassisNotification Clear
7-2051-1	tmnxEqPowerSupplyFailureOutput	Power supply 1 output failure	tmnxChassisNotification Clear
7-2073-x	same as 7-2019-x but for the BITS2 input	same as 7-2019-x but for the BITS2 input	same as 7-2019-x but for the BITS2 input
59-2004-1	linkDown	Interface intf-towards-node-B22 is not operational	linkUp

Table 53: Alarm Name/Raising Event, Cause, Effect and Recovery

Alarm *1	Alarm Name/Raising Event	Cause	Effect	Recovery
7-2001-1	tmnxEqCardFailure	Generated when one of the cards in a chassis has failed. The card type may be IOM , MDA , , CCM, CPM, Compact Flash, etc. The reason is indicated in the details of the log event or alarm, and also available in the tmnxChassisNotifyCardFailure Reason attribute included in the SNMP notification.	The effect is dependant on the card that has failed. IOM or MDA failure will cause a loss of service for all services running on that card. A fabric failure can impact traffic to/from all cards.	Before taking any recovery steps collect a tech-support file, then try resetting (clear) the card. If that doesn't work then try removing and then re-inserting the card. If that doesn't work then replace the card.
7-2003-1	tmnxEqCardRemoved	Generated when a card is removed from the chassis. The card type may be IOM , MDA , , CCM, CPM, Compact Flash, etc.	The effect is dependant on the card that has been removed. IOM or MDA removal will cause a loss of service for all services running on that card. A fabric removal can impact traffic to/ from all cards.	Before taking any recovery steps collect a tech-support file, then try re-inserting the card. If that doesn't work then replace the card.
7-2004-1	tmnxEqWrongCard	Generated when the wrong type of card is inserted into a slot of the chassis. Even though a card may be physically supported by the slot, it may have been administratively configured to allow only certain card types in a particular slot location. The card type may be IOM , MDA , , CCM, CPM, Compact Flash, etc.	The effect is dependant on the card that has been incorrectly inserted. Incorrect IOM or MDAnsertion will cause a loss of service for all services running on that card.	Insert the correct card into the correct slot, and ensure the slot is configured for the correct type of card.
7-2005-1	tmnxEnvTempTooHigh	Generated when the temperature sensor reading on an equipment object is greater than its configured threshold.	This could be causing intermittent errors and could also cause permanent damage to components.	Remove or power down the affected cards, or improve the cooling to the node. More powerful fan trays may also be required.

Table 53: Alarm Name/Raising Event, Cause, Effect and Recovery (Continued)

Alarm *1	Alarm Name/Raising Event	Cause	Effect	Recovery
7-2006-1	tmnxEqFanFailure	Generated when one of the fans in a fan tray has failed.	This could be cause temperature to rise and resulting intermittent errors and could also cause permanent damage to components.	Replace the fan tray immediately, improve the cooling to the node, or reduce the heat being generated in the node by removing cards or powering down the node.
7-2007-1	tmnxEqPowerSupplyFailureOvt	Generated when the temperature sensor reading on a power supply module is greater than its configured threshold.	This could be causing intermittent errors and could also cause permanent damage to components.	Remove or power down the affected power supply module or improve the cooling to the node. More powerful fan trays may also be required. The power supply itself may be faulty so replacement may be necessary.
7-2008-1	tmnxEqPowerSupplyFailureAc	Generated when an AC failure is detected on a power supply.	Reduced power can cause intermittent errors and could also cause permanent damage to components.	First try re-inserting the power supply. If that doesn't work, then replace the power supply.
7-2009-1	tmnxEqPowerSupplyFailureDc	Generated when an DC failure is detected on a power supply.	Reduced power can cause intermittent errors and could also cause permanent damage to components.	First try re-inserting the power supply. If that doesn't work, then replace the power supply.
7-2011-1	tmnxEqPowerSupplyRemoved	Generated when one of the chassis's power supplies is removed.	Reduced power can cause intermittent errors and could also cause permanent damage to components.	Re-insert the power supply.

Table 53: Alarm Name/Raising Event, Cause, Effect and Recovery (Continued)

Alarm *1	Alarm Name/Raising Event	Cause	Effect	Recovery
7-2017-1	tmnxEqSyncIfTimingHoldover	Generated when the synchronous equipment timing subsystem transitions into a holdover state.	Any node-timed ports will have very slow frequency drift limited by the central clock oscillator stability. The oscillator meets the holdover requirements of a Stratum 3 and G.813 Option 1 clock.	Address issues with the central clock input references.
7-2019-1	tmnxEqSyncIfTimingRef1Alarm with attribute tmnxSyncIfTimingNotifyAlarm == 'los(1)'	Generated when an alarm condition on the first timing reference is detected. The type of alarm (los, oof, etc) is indicated in the details of the log event or alarm, and is also available in the tmnxSyncIfTimingNotifyAlarm attribute included in the SNMP notification. The SNMP notification will have the same indices as those of the tmnxCpmCardTable.	Timing reference 1 cannot be used as a source of timing into the central clock.	Address issues with the signal associated with timing reference 1.
7-2019-2	tmnxEqSyncIfTimingRef1Alarm with attribute tmnxSyncIfTimingNotifyAlarm == 'oof(2)'	same as 7-2019-1	same as 7-2019-1	same as 7-2019-1
7-2019-3	tmnxEqSyncIfTimingRef1Alarm with attribute tmnxSyncIfTimingNotifyAlarm == 'oopir(3)'	same as 7-2019-1	same as 7-2019-1	same as 7-2019-1
7-2021-x	same as 7-2019-x but for ref2	same as 7-2019-x but for the second timing reference	same as 7-2019-x but for the second timing reference	same as 7-2019-x but for the second timing reference
7-2030-x	same as 7-2019-x but for the BITS input	same as 7-2019-x but for the BITS timing reference	same as 7-2019-x but for the BITS timing reference	same as 7-2019-x but for the BITS timing reference

Table 53: Alarm Name/Raising Event, Cause, Effect and Recovery (Continued)

Alarm *1	Alarm Name/Raising Event	Cause	Effect	Recovery
7-2033-1	tmnxChassisUpgradeInProgress	The tmnxChassisUpgradeInProgress notification is generated only after a CPM switchover occurs and the new active CPM is running new software, while the IOMs are still running old software. This is the start of the upgrade process. The tmnxChassisUpgradeInProgress notification will continue to be generated every 30 minutes while at least one IOM is still running older software.	A s/w mismatch between the CPM and IOM is generally fine for a short duration (during an upgrade) but may not allow for correct long term operation.	Complete the upgrade of all IOMs.
7-2050-1	tmnxEqPowerSupplyFailureInput	Generated when an input failure is detected on a power supply.	Reduced power can cause intermittent errors and could also cause permanent damage to components.	First try re-inserting the power supply. If that doesn't work, then replace the power supply.

Table 53: Alarm Name/Raising Event, Cause, Effect and Recovery (Continued)

Alarm *1	Alarm Name/Raising Event	Cause	Effect	Recovery
7-2051-1	tmnxEqPowerSupplyFailureOutput	Generated when an output failure is detected on a power supply.	Reduced power can cause intermittent errors and could also cause permanent damage to components.	First try re-inserting the power supply. If that doesn't work, then replace the power supply.
7-2073-x	same as 7-2019-x but for the BITS2 input	same as 7-2019-x but for the BITS 2 timing reference	same as 7-2019-x but for the BITS 2 timing reference	same as 7-2019-x but for the BITS 2 timing reference
59-2004-1	linkDown	A linkDown trap signifies that the SNMP entity, acting in an agent role, has detected that the ifOperStatus object for one of its communication links is about to enter the down state from some other state (but not from the notPresent state).	The indicated interface is taken down.	If the ifAdminStatus is down then the interface state is deliberate and there is no recovery. If the ifAdminStatus is up then try to determine that cause of the interface going down: cable cut, distal end went down, etc.

The linkDown Facility Alarm is supported for the following objects (note that all objects may not be supported on all platforms):

Table 54: linkDown Facility Alarm Support

Object	Supported?
Ethernet Ports	Yes
Sonet Section, Line and Path (POS)	Yes
TDM Ports (E1, T1, DS3) including CES MDAs/CMAs	Yes
TDM Channels (DS3 channel configured in an STM-1 port)	Yes
ATM Ports	Yes
Ethernet LAGs	No
APS groups	No
Bundles (MLPPP, IMA, etc)	No
ATM channels, Ethernet VLANs, Frame Relay DLCIs	No

Configuring Logging with CLI

This section provides information to configure logging using the command line interface.

Topics in this section include:

- [Basic Facility Alarm Configuration on page 514](#)
- [Common Configuration Tasks on page 515](#)

Basic Facility Alarm Configuration

The most facility alarm configuration must have the following:

- Log ID or accounting policy ID
- A log source
- A log destination

The following displays an alarm configuration example.

```
A:ALA-12>config>system# alarms
#-----
      no shutdown
      exit
-----
```

Common Configuration Tasks

The following sections are basic alarm tasks that can be performed.

- [Configuring the Maximum Number of Alarms To Clear on page 515](#)
-

Configuring the Maximum Number of Alarms To Clear

The number of alarms to clear can be configured using the command listed below.

Use the following CLI syntax to configure a log file:

CLI Syntax: `config>system
 alarms
 max-cleared max-alarms`

The following displays facility alarm configuration example:

```
ALA-12>config>system# alarms
-----
...
max-cleared 100
exit
...
-----
```

Facility Alarms Command Reference

Command Hierarchies

- [Facility Alarm Configuration Commands on page 517](#)
- [Show Commands on page 517](#)

Facility Alarm Configuration Commands

```
config
  — system
    — alarms
      — max-cleared max-alarms
      — [no] shutdown
```

Show Commands

```
show
  — system
    — alarms [cleared] [severity severity-level] [count count] [newer-than days]
```

Configuration Commands

Generic Commands

alarms

Syntax	alarms
Context	config>system
Description	This command enters the context to configure facility alarm parameters.

max-cleared

Syntax	max-cleared <i>max-alarms</i>
Context	config>system>alarms
Description	This command configures the maximum number of cleared alarms that the system will store and display.
Default	500
Parameters	<i>max-alarms</i> — Specify the maximum number of cleared alarms.

shutdown

Syntax	[no] shutdown
Context	config>system>alarms
Description	This command enables or disables the Facility Alarm functionality. When enabled, the Facility Alarm sub-system tracks active and cleared facility alarms and controls the Alarm LEDs on the CPMs/CFMs. When Facility Alarm functionality is enabled, the alarms are viewed using the <code>show system alarms</code> command(s).
Default	no shutdown

Show Commands

alarms

- Syntax** `alarms [cleared] [severity severity-level] [count count] [newer-than days]`
- Context** `show>system`
- Description** This command displays facility alarms on the system.
- Output** **Facility Alarm Output** — The following table describes the alarms output fields.

Sample Output

Table 55: Show Facility Alarms Output Fields

Label	Description
Index	Alarm index number.
Date/Time	Date and time string for the alarm.
Severity	Severity level of the alarm.
Alarm	Alarm identifier.
Resource	Facility associated with the alarm.
Details	Description of the alarm.

```
A:Dut-A# show system alarms
=====
Alarms [Critical:1 Major:2 Minor:0 Warning:0 Total:3]
=====
Index      Date/Time          Severity    Alarm        Resource
  Details
-----
8          2011/04/01 18:36:43.80 MAJOR       7-2011-1     Power Supply 1
  Power supply 1, power lost

7          2011/04/01 18:35:57.00 MAJOR       7-2005-1     Chassis 1
  Chassis 1: temperature too high

6          2011/04/01 18:35:24.80 CRITICAL    7-2006-1     Fan 1
  Fan 1 failed
=====
```

Cleared alarms table:

```
A:Dut-A# show system alarms cleared
=====
```

Show Commands

```
Cleared Alarms [Size:500 Total:5 (not wrapped)]
=====
Index      Date/Time                Severity    Alarm      Resource
  Details
-----
5          2011/04/01 18:11:55.00 MAJOR      7-2005-1   Chassis 1
  Clear Chassis temperature too high alarm

3          2011/04/01 18:11:54.50 CRITICAL   7-2051-1   Power Supply 1
  Clear Power Supply failure

2          2011/04/01 18:11:54.40 CRITICAL   7-2050-1   Power Supply 1
  Clear Power Supply failure

4          2011/04/01 18:11:54.10 MINOR      7-2004-1   Fan 1
  Clear Fan wrong type failure

1          2011/04/01 18:11:54.00 CRITICAL   7-2007-1   Power Supply 1
  Clear Power Supply failure
=====
```

Standards and Protocol Support

Ethernet Standards

IEEE 802.1ab-REV/D3 Station and Media Access Control Connectivity Discovery
IEEE 802.1d Bridging
IEEE 802.1p/Q VLAN Tagging
IEEE 802.1s Multiple Spanning Tree
IEEE 802.1w Rapid Spanning Tree Protocol
IEEE 802.1x Port Based Network Access Control
IEEE 802.1ad Provider Bridges
IEEE 802.1ah Provider Backbone Bridges
IEEE 802.1ag Service Layer OAM
IEEE 802.3ah Ethernet in the First Mile
IEEE 802.1ak Multiple MAC Registration Protocol
IEEE 802.3 10BaseT
IEEE 802.3ad Link Aggregation
IEEE 802.3ae 10Gbps Ethernet
IEEE 802.3ah Ethernet OAM
IEEE 802.3u 100BaseTX
IEEE 802.3x Flow Control
IEEE 802.3z 1000BaseSX/LX
ITU-T Y.1731 OAM functions and mechanisms for Ethernet based networks
ITU-T G.8031 Ethernet linear protection switching
ITU-T G.8032 Ethernet Ring Protection Switching (version 2)

OSPF

RFC 1765 OSPF Database Overflow
RFC 2328 OSPF Version 2
RFC 2370 Opaque LSA Support
RFC 2740 OSPF for IPv6 (OSPFv3)
draft-ietf-ospf-ospfv3-update-14.txt
RFC 3101 OSPF NSSA Option
RFC 3137 OSPF Stub Router Advertisement
RFC 3623 Graceful OSPF Restart – GR helper

RFC 3630 Traffic Engineering (TE) Extensions to OSPF Version 2
RFC 4203 OSPF Extensions in Support of Generalized Multi-Protocol Label Switching (GMPLS) - (support of Link Local/Remote Identifiers and SRLG sub-TLVs)
RFC 5185 OSPF Multi-Area Adjacency
RFC5243 OSPF Database Summary List Optimization

BGP

RFC 1397 BGP Default Route Advertisement
RFC 1772 Application of BGP in the Internet
RFC 1965 Confederations for BGP
RFC 1997 BGP Communities Attribute
RFC 2385 Protection of BGP Sessions via MD5
RFC 2439 BGP Route Flap Dampening
RFC 2558 Multiprotocol Extensions for BGP-4
RFC 2918 Route Refresh Capability for BGP-4
RFC 3107 Carrying Label Information in BGP-4
RFC 3392 Capabilities Advertisement with BGP4
RFC 4271 BGP-4 (previously RFC 1771)
RFC 4360 BGP Extended Communities Attribute
RFC 4364 BGP/MPLS IP Virtual Private Networks (VPNs)(previously RFC 2547bis BGP/MPLS VPNS)
RFC 4456 BGP Route Reflection: Alternative to Full-mesh IBGP (previously RFC 1966 & 2796)
RFC 4486 Subcodes for BGP Cease Notification Message
RFC 4577 OSPF as the Provider/Customer Edge Protocol for BGP/MPLS IP Virtual Private Networks (VPNs)

RFC 4659 BGP/MPLS IP Virtual Private Network (VPN) Extension for IPv6 VPN
RFC 4684 Constrained Route Distribution for Border Gateway Protocol/MultiProtocol Label Switching (BGP/MPLS) Internet Protocol (IP) Virtual Private Networks (VPNs)
RFC 4724 Graceful Restart Mechanism for BGP – GR helper
RFC 4760 Multi-protocol Extensions for BGP
RFC 4798 Connecting IPv6 Islands over IPv4 MPLS Using IPv6 Provider Edge Routers (6PE)
RFC 4893 BGP Support for Four-octet AS Number Space
RFC 5004 Avoid BGP Best Path Transitions from One External to Another
RFC 5065 Confederations for BGP (obsoletes 3065)
RFC 5291 Outbound Route Filtering Capability for BGP-4
RFC 5575 Dissemination of Flow Specification Rules
RFC 5668 4-Octet AS Specific BGP Extended Community
draft-ietf-idr-add-paths
draft-ietf-idr-best-external

IS-IS

ISO/IEC 10589:2002, Second Edition Intermediate System to Intermediate System Intra-Domain Routeing Information Exchange Protocol
RFC 1195 Use of OSI IS-IS for Routing in TCP/IP and Dual Environments
RFC 2973 IS-IS Mesh Groups
RFC 3359 Reserved Type, Length and Value (TLV) Codepoints in Intermediate System to Intermediate System
RFC 3719 Recommendations for Interoperable Networks using

Standards and Protocols

Intermediate System to Intermediate System (IS-IS)
RFC 3787 Recommendations for Interoperable IP Networks using Intermediate System to Intermediate System (IS-IS)
RFC 5120 M-ISIS: Multi Topology (MT) Routing in IS-IS (Partial)
RFC 5301 Dynamic Hostname Exchange Mechanism for IS-IS
RFC 5302 Domain-wide Prefix Distribution with Two-Level IS-IS
RFC 5303 Three-Way Handshake for IS-IS Point-to-Point Adjacencies
RFC 5304 IS-IS Cryptographic Authentication
RFC 5305 IS-IS Extensions for Traffic Engineering TE
RFC 5306 Restart Signaling for IS-IS
RFC 5307 IS-IS Extensions in Support of Generalized Multi-Protocol Label Switching (GMPLS)
RFC 5309 Point-to-Point Operation over LAN in Link State Routing Protocols
RFC 6329 IS-IS Extensions Supporting IEEE 802.1aq Shortest Path Bridging (Partial)
draft-ietf-isis-mi IS-IS Multi-Instance

IPSec

RFC 2401 Security Architecture for the Internet Protocol
RFC 2406 IP Encapsulating Security Payload (ESP)
RFC 2409 The Internet Key Exchange (IKE)
RFC 2560 X.509 Internet Public Key Infrastructure Online Certificate Status Protocol - OCSP
RFC 3706 IKE Dead Peer Detection
RFC 3947 Negotiation of NAT-Traversal in the IKE
RFC 3948 UDP Encapsulation of IPsec ESP Packets
RFC 4210 Internet X.509 Public Key Infrastructure Certificate Management Protocol (CMP)
RFC 4211 Internet X.509 Public Key Infrastructure

Certificate Request Message Format (CRMF)
RFC 5996 Internet Key Exchange Protocol Version 2 (IKEv2)
RFC 5998 An Extension for EAP-Only Authentication in IKEv2
draft-ietf-ipsec-isakmp-xauth-06.txt – Extended Authentication within ISAKMP/Oakley (XAUTH)
draft-ietf-ipsec-isakmp-modecfg-05.txt – The ISAKMP Configuration Method

IPv6

RFC 1981 Path MTU Discovery for IPv6
RFC 2375 IPv6 Multicast Address Assignments
RFC 2460 Internet Protocol, Version 6 (IPv6) Specification
RFC 2461 Neighbor Discovery for IPv6
RFC 2462 IPv6 Stateless Address Auto configuration
RFC 2463 Internet Control Message Protocol (ICMPv6) for the Internet Protocol Version 6 Specification
RFC 2464 Transmission of IPv6 Packets over Ethernet Networks
RFC 2529 Transmission of IPv6 over IPv4 Domains without Explicit Tunnels
RFC 2545 Use of BGP-4 Multiprotocol Extension for IPv6 Inter-Domain Routing
RFC 2710 Multicast Listener Discovery (MLD) for IPv6
RFC 2740 OSPF for IPv6
RFC 3306 Unicast-Prefix-based IPv6 Multicast Addresses
RFC 3315 Dynamic Host Configuration Protocol for IPv6
RFC 3587 IPv6 Global Unicast Address Format
RFC3590 Source Address Selection for the Multicast Listener Discovery (MLD) Protocol
RFC 3810 Multicast Listener Discovery Version 2 (MLDv2) for IPv6
RFC 4007 IPv6 Scoped Address Architecture
RFC 4193 Unique Local IPv6 Unicast Addresses
RFC 4291 IPv6 Addressing Architecture

RFC 4552 Authentication/Confidentiality for OSPFv3
RFC 4659 BGP-MPLS IP Virtual Private Network (VPN) Extension for IPv6 VPN
RFC 5072 IP Version 6 over PPP
RFC 5095 Deprecation of Type 0 Routing Headers in IPv6
draft-ietf-isis-ipv6-05
draft-ietf-isis-wg-multi-topology-xx.txt

Multicast

RFC 1112 Host Extensions for IP Multicasting (Snooping)
RFC 2236 Internet Group Management Protocol, (Snooping)
RFC 3376 Internet Group Management Protocol, Version 3 (Snooping)
RFC 2362 Protocol Independent Multicast-Sparse Mode (PIMSM)
RFC 3618 Multicast Source Discovery Protocol (MSDP)
RFC 3446 Anycast Rendezvous Point (RP) mechanism using Protocol Independent Multicast (PIM) and Multicast Source Discovery Protocol (MSDP)
RFC 4601 Protocol Independent Multicast - Sparse Mode (PIM-SM): Protocol Specification (Revised)
RFC 4604 Using IGMPv3 and MLDv2 for Source-Specific Multicast
RFC 4607 Source-Specific Multicast for IP
RFC 4608 Source-Specific Protocol Independent Multicast in 232/8
RFC 4610 Anycast-RP Using Protocol Independent Multicast (PIM)
draft-ietf-pim-sm-bsr-06.txt
draft-rosen-vpn-mcast-15.txt
Multicast in MPLS/BGP IP VPNs
draft-ietf-mboned-msdp-mib-01.txt
draft-ietf-l3vpn-2547bis-mcast-07: Multicast in MPLS/BGP IP VPNs

draft-ietf-l3vpn-2547bis-mcast-bgp-05: BGP Encodings and Procedures for Multicast in MPLS/BGP IP VPNs
 RFC 3956: Embedding the Rendezvous Point (RP) Address in an IPv6 Multicast Address

MPLS-GENERAL

RFC 2430 A Provider Architecture DiffServ & TE
 RFC 2474 Definition of the DS Field the IPv4 and IPv6 Headers (Rev)
 RFC 2597 Assured Forwarding PHB Group (rev3260)
 RFC 2598 An Expedited Forwarding PHB
 RFC 3031 MPLS Architecture
 RFC 3032 MPLS Label Stack Encoding
 RFC 3443 Time To Live (TTL) Processing in Multi-Protocol Label Switching (MPLS) Networks
 RFC 4182 Removing a Restriction on the use of MPLS Explicit NULL
 RFC 3140 Per-Hop Behavior Identification Codes
 RFC 5332 MPLS Multicast Encapsulations

MPLS — LDP

RFC 3037 LDP Applicability
 RFC 3478 Graceful Restart Mechanism for LDP – GR helper
 RFC 5036 LDP Specification
 RFC 5283 LDP extension for Inter-Area LSP
 RFC 5443 LDP IGP Synchronization
 RFC 6388 LDP Extensions for Point-to-Multipoint and Multipoint-to-Multipoint LSP
 RFC 6826 Multipoint LDP in-band signaling for Point-to-Multipoint and Multipoint-to-Multipoint Label Switched Paths
 draft-pdutta-mpls-ldp-hello-reduce-04.txt, Targeted LDP Hello Reduction

MPLS/RSVP-TE

RFC 2702 Requirements for Traffic Engineering over MPLS
 RFC2747 RSVP Cryptographic Authentication

RFC 2961 RSVP Refresh Overhead Reduction Extensions
 RFC3097 RSVP Cryptographic Authentication - Updated Message Type Value
 RFC 3209 Extensions to RSVP for Tunnels
 RFC 3473 Generalized Multi-Protocol Label Switching (GMPLS) Signaling
 Resource ReserVation Protocol-Traffic Engineering (RSVP-TE) Extensions – (support of of IF_ID RSVP_HOP object with unnumbered interface and RSVP-TE Graceful Restart Helper Procedures)
 RFC 3477 Signalling Unnumbered Links inResourceReSerVationProtocol-Traffic Engineering (RSVP-TE)
 RFC 3564 Requirements for Diff-Serv-aware TE
 RFC 3906 Calculating Interior Gateway Protocol (IGP) Routes Over Traffic Engineering Tunnels
 RFC 4090 Fast reroute Extensions to RSVP-TE for LSP Tunnels
 RFC 4124 Protocol Extensions for Support of Diffserv-aware MPLS Traffic Engineering
 RFC 4125 Maximum Allocation Bandwidth Constraints Model for Diffserv-aware MPLS Traffic Engineering
 RFC 4127 Russian Dolls Bandwidth Constraints Model for Diffserv-aware MPLS Traffic Engineering
 draft-newton-mpls-te-dynamic-overbooking-00 A Diffserv-TE Implementation Model to dynamically change booking factors during failure events
 RFC 4561 Definition of a RRO Node-Id Sub-Object
 RFC 4875 Extensions to Resource Reservation Protocol - Traffic Engineering (RSVP-TE) for Point-to-Multipoint TE Label Switched Paths (LSPs)
 RFC 5151 Inter-domain MPLS and GMPLS Traffic Engineering – RSVP-TE Extensions
 RFC 5712 MPLS Traffic Engineering Soft Preemption

RFC 5817 Graceful Shutdown in GMPLS Traffic Engineering Networks

MPLS — OAM

RFC 4379 Detecting Multi-Protocol Label Switched (MPLS) Data Plane Failures
 RFC 6425 Detecting Data Plane Failures in Point-to-Multipoint Multiprotocol Label Switching (MPLS) - Extensions to LSP Ping

MPLS-TP (7750/7450 only)

RFC5586 MPLS Generic Associated Channel
 RFC5921 A Framework for MPLS in Transport Networks
 RFC5960 MPLS Transport Profile Data Plane Architecture
 RFC6370 MPLS-TP Identifiers
 RFC6378 MPLS-TP Linear Protection
 RFC6428 Proactive Connectivity Verification, Continuity Check and Remote Defect indication for MPLS Transport Profile
 RFC6426 MPLS On-Demand Connectivity and Route Tracing
 RFC6478 Pseudowire Status for Static Pseudowires
 draft-ietf-mpls-tp-ethernet-addressing-02 MPLS-TP Next-Hop Ethernet Addressing

RIP

RFC 1058 RIP Version 1
 RFC 2080 RIPng for IPv6
 RFC 2082 RIP-2 MD5 Authentication
 RFC 2453 RIP Version 2

TCP/IP

RFC 768 UDP
 RFC 1350 The TFTP Protocol (Rev.
 RFC 791 IP
 RFC 792 ICMP
 RFC 793 TCP
 RFC 826 ARP
 RFC 854 Telnet
 RFC 951 BootP (rev)
 RFC 1519 CIDR
 RFC 1542 Clarifications and Extensions for the Bootstrap Protocol
 RFC 1812 Requirements for IPv4 Routers

Standards and Protocols

RFC 2347 TFTP option Extension
RFC 2328 TFTP Blocksize Option
RFC 2349 TFTP Timeout Interval and Transfer
Size option
RFC 2401 Security Architecture for Internet Protocol
RFC 2428 FTP Extensions for IPv6 and NATs
RFC 3596 DNS Extensions to Support IP version 6
draft-ietf-bfd-mib-00.txt Bidirectional Forwarding Detection Management Information Base
RFC 5880 Bidirectional Forwarding Detection
RFC 5881 BFD IPv4 and IPv6 (Single Hop)
RFC 5883 BFD for Multihop Paths
RFC 5286 Basic Specification for IP Fast Reroute: Loop-Free Alternates

RRRP

RFC 2787 Definitions of Managed Objects for the Virtual Router Redundancy Protocol
RFC 3768 Virtual Router Redundancy Protocol
draft-ietf-rrrp-unified-spec-02: Virtual Router Redundancy Protocol Version 3 for IPv4 and IPv6

PPP

RFC 1332 PPP IPCP
RFC 1377 PPP OSINLCP
RFC 1638/2878 PPP BCP
RFC 1661 PPP (rev RFC2151)
RFC 1662 PPP in HDLC-like Framing
RFC 1877 PPP Internet Protocol Control Protocol Extensions for Name Server Addresses
RFC 1989 PPP Link Quality Monitoring
RFC 1990 The PPP Multilink Protocol (MP)
RFC 1994 "PPP Challenge Handshake Authentication Protocol (CHAP)
RFC 2516 A Method for Transmitting PPP Over Ethernet RFC 2615 PPP over SONET/SDH
RFC 2686 The Multi-Class Extension to Multi-Link PPP

Frame Relay

FRF.1.2 - PVC User-to-Network Interface (UNI) Implementation Agreement
FRF.5 - Frame Relay/ATM PVC Network Interworking Implementation
ANSI T1.617 Annex D, DSS1 — Signalling Specification For Frame Relay Bearer Service.
FRF2.2 -PVC Network-to- Network Interface (NNI) Implementation Agreement.
FRF.12 Frame Relay Fragmentation Implementation Agreement
FRF.16.1 Multilink Frame Relay UNI/ NNI Implementation Agreement
ITU-T Q.933 Annex A- Additional procedures for Permanent Virtual Connection (PVC) status management

ATM

RFC 1626 Default IP MTU for use over ATM AAL5
RFC 2514 Definitions of Textual Conventions and OBJECT_IDENTITIES for ATM Management
RFC 2515 Definition of Managed Objects for ATM Management RFC 2684 Multiprotocol Encapsulation over ATM Adaptation Layer 5
AF-TM-0121.000 Traffic Management Specification Version 4.1
ITU-T Recommendation I.610 - B-ISDN Operation and Maintenance Principles and Functions version 11/95
ITU-T Recommendation I.432.1 – BISDN user-network interface – Physical layer specification: General characteristics
GR-1248-CORE - Generic Requirements for Operations of ATM Network Elements (NEs). Issue 3
GR-1113-CORE - Bellcore, Asynchronous Transfer Mode (ATM) and ATM Adaptation Layer (AAL) Protocols Generic Requirements, Issue 1
AF-ILMI-0065.000 Integrated Local Management Interface (ILMI) Version 4.0

AF-TM-0150.00 Addendum to Traffic Management v4.1 optional minimum desired cell rate indication for UBR
AF-PHY-0086.001, Inverse Multiplexing for ATM (IMA) Specification Version 1.1

DHCP

RFC 2131 Dynamic Host Configuration Protocol (REV)
RFC 3046 DHCP Relay Agent Information Option (Option 82)
RFC 1534 Interoperation between DHCP and BOOTP

Policy Management and Credit Control

3GPP TS 29.212 - Policy and Charging Control (PCC) over Gx/Sd Reference Point (Release 11) - Gx support as it applies to wireline environment (BNG)
RFC 3588 – Diameter Base Protocol
RFC 4006 – Diameter Credit Control Application

NAT

RFC 6333 Dual-Stack Lite Broadband Deployments Following IPv4 Exhaustion
RFC 6334 Dynamic Host Configuration Protocol for IPv6 (DHCPv6) Option for Dual-Stack Lite
RFC 6888 Common Requirements For Carrier-Grade NATs (CGNs)
RFC 5508 NAT Behavioral Requirements for ICMP
RFC 5382 NAT Behavioral Requirements for TCP
RFC 6146 Statefull NAT64

VPLS

RFC 4762 Virtual Private LAN Services Using LDP
RFC5501: Requirements for Multicast Support in Virtual Private LAN Services (previously draft-ietf-l2vpn-vpls-mcast-reqts-04)
RFC6074: Provisioning, Auto-Discovery, and Signaling in Layer 2 Virtual Private Networks (L2VPNs) (previously draft-ietf-l2vpn-signaling-08)

draft-ietf-l2vpn-vpls-mcast-13.txt
Multicast in VPLS

RFC 7041 Extensions to the Virtual Private LAN Service (VPLS) Provider Edge (PE) Model for Provider Backbone Bridging

Pseudowire

RFC 3985 Pseudo Wire Emulation Edge-to-Edge (PWE3)

RFC 4385 Pseudo Wire Emulation Edge-to-Edge (PWE3) Control Word for Use over an MPLS PSN

RFC 3916 Requirements for Pseudo-Wire Emulation Edge-to-Edge (PWE3)

RFC 4717 Encapsulation Methods for Transport ATM over MPLS Networks (draft-ietf-pwe3-atm-encap-10.txt)

RFC 4816 PWE3 ATM Transparent Cell Transport Service (draft-ietf-pwe3-cell-transport-04.txt)

RFC 4448 Encapsulation Methods for Transport of Ethernet over MPLS Networks (draft-ietf-pwe3-ethernet-encap-11.txt)

RFC 4619 Encapsulation Methods for Transport of Frame Relay over MPLS Networks (draft-ietf-pwe3-frame-relay-07.txt)

RFC 4446 IANA Allocations for PWE3

RFC 4447 Pseudowire Setup and Maintenance Using LDP (draft-ietf-pwe3-control-protocol-17.txt)

RFC 5085, Pseudowire Virtual Circuit Connectivity Verification (VCCV): A Control Channel for Pseudowires

RFC 5659 An Architecture for Multi-Segment Pseudowire Emulation Edge-to-Edge

draft-ietf-l2vpn-vpws-iw-oam-03.txt, OAM Procedures for VPWS Interworking

draft-ietf-pwe3-mppls-eth-oam-iwk-07.txt, MPLS and Ethernet OAM Interworking RFC6073, Segmented Pseudowire

draft-ietf-pwe3-dynamic-ms-pw-16.txt, Dynamic Placement of Multi Segment Pseudo Wires

RFC 6310, Pseudowire (PW) OAM Message Mapping

RFC6391 Flow Aware Transport of Pseudowires over an MPLS PSN

RFC 6575, ARP Mediation for IP Interworking of Layer 2 VPN

RFC 6718, Pseudowire Redundancy

RFC 6870, Pseudowire Preferential Forwarding Status bit

MFA Forum 9.0.0 The Use of Virtual trunks for ATM/MPLS Control Plane Interworking

MFA Forum 12.0.0 Multiservice Interworking - Ethernet over MPLS

MFA forum 13.0.0 - Fault Management for Multiservice Interworking v1.0

MFA Forum 16.0.0 – Multiservice Interworking - IP over MPLS

ANCP/L2CP

RFC5851 ANCP framework
draft-ietf-ancp-protocol-02.txt ANCP Protocol

Voice /Video Performance:

ITU-T G.107 The E Model- A computational model for use in planning.

ETSI TS 101 329-5 Annex E extensions- QoS Measurement for VoIP - Method for determining an Equipment Impairment Factor using Passive Monitoring

ITU-T Rec. P.564 - Conformance testing for voice over IP transmission quality assessment models

ITU-T G.1020 - Appendix I- Performance Parameter Definitions for Quality of Speech and other Voiceband Applications Utilizing IP Networks- Mean Absolute Packet Delay Variation.& Markov Models.

RFC 3550 Appendix A.8- RTP: A Transport Protocol for Real-Time Applications- Estimating the Interarrival Jitter.

Circuit Emulation

RFC 4553 Structure-Agnostic Time Division Multiplexing (TDM) over Packet (SAToP)

RFC 5086 Structure-Aware Time Division Multiplexed (TDM) Circuit Emulation Service over Packet Switched Network (CESoPSN)

MEF-8 Implementation Agreement for the Emulation of PDH Circuits over Metro Ethernet Networks, October 2004

RFC 5287 Control Protocol Extensions for the Setup of Time-Division Multiplexing (TDM) Pseudowires in MPLS Networks

SONET/SDH

ITU-G.841 Telecommunication Standardization Section of ITU, Types and Characteristics of SDH Networks Protection Architecture, issued in October 1998 and as augmented by Corrigendum1 issued in July 2002

AAA

RFC 2865 Remote Authentication Dial In User Service

RFC 2866 RADIUS Accounting
draft-grant-tacacs-02.txt

SSH

RFC 4250 The Secure Shell (SSH) Protocol Protocol Assigned Numbers

RFC 4251 The Secure Shell (SSH) Protocol Architecture

RFC 4254 The Secure Shell (SSH) Connection Protocol

OpenFlow

ONF OpenFlow Switch Specification version 1.3.1 (Hybrid-switch/ FlowTable)

Timing

GR-253-CORE SONET Transport Systems: Common Generic Criteria. Issue 3, September 2000

ITU-T G.781 Telecommunication Standardization Section of ITU, Synchronization layer functions, issued 09/2008

ITU-T G.813 Telecommunication Standardization Section of ITU, Timing characteristics of SDH equipment slave clocks (SEC), issued 03/2003.

GR-1244-CORE Clocks for the Synchronized Network: Common Generic Criteria, Issue 3, May 2005

Standards and Protocols

ITU-T G.8261 Telecommunication Standardization Section of ITU, Timing and synchronization aspects in packet networks, issued 04/2008.

ITU-T G.8262 Telecommunication Standardization Section of ITU, Timing characteristics of synchronous Ethernet equipment slave clock (EEC), issued 08/2007.

ITU-T G.8264 Telecommunication Standardization Section of ITU, Distribution of timing information through packet networks, issued 10/2008.

ITU-T G.8265.1 Telecommunication Standardization Section of ITU, Precision time protocol telecom profile for frequency synchronization, issued 10/2010.

Network Management

ITU-T X.721: Information technology-OSI-Structure of Management Information

ITU-T X.734: Information technology-OSI-Systems Management: Event Report Management Function

M.3100/3120 Equipment and Connection Models

TMF 509/613 Network Connectivity Model

RFC 1157 SNMPv1

RFC 1215 A Convention for Defining Traps for use with the SNMP

RFC 1657 BGP4-MIB

RFC 1724 RIPv2-MIB

RFC 1850 OSPF-MIB

RFC 1907 SNMPv2-MIB

RFC 2011 IP-MIB

RFC 2138 RADIUS

RFC 2206 RSVP-MIB

RFC 2452 IPv6 Management Information Base for the Transmission Control Protocol

RFC 2465 Management Information Base for IPv6: Textual Conventions and General Group

RFC 2558 SONET-MIB

RFC 2571 SNMP-FRAMEWORKMIB

RFC 2572 SNMP-MPD-MIB

RFC 2573 SNMP-TARGET-&-NOTIFICATION-MIB

RFC 2574 SNMP-USER-BASED-SMMIB

RFC 2575 SNMP-VIEW-BASED-ACM-MIB

RFC 2576 SNMP-COMMUNITY-MIB

RFC 2578 Structure of Management Information Version 2 (SMIV2)

RFC 2665 EtherLike-MIB

RFC 2819 RMON-MIB

RFC 2863 IF-MIB

RFC 2864 INVERTED-STACK-MIB

RFC 2987 VRRP-MIB

RFC 3014 NOTIFICATION-LOGMIB

RFC 3019 IP Version 6 Management Information Base for The Multicast Listener Discovery Protocol

RFC 3164 Syslog

RFC 3273 HCRMON-MIB

RFC 3411 An Architecture for Describing Simple Network Management Protocol (SNMP) Management Frameworks

RFC 3412 - Message Processing and Dispatching for the Simple Network Management Protocol (SNMP)

RFC 3413 - Simple Network Management Protocol (SNMP) Applications

RFC 3414 - User-based Security Model (USM) for version 3 of the Simple Network Management Protocol (SNMPv3)

RFC 3418 - SNMP MIB

RFC 3826 The Advanced Encryption Standard (AES) Cipher Algorithm in the SNMP User-based Security Model

RFC 4113 Management Information Base for the User Datagram Protocol (UDP)

RFC 4292 IP-FORWARD-MIB

RFC 4293 MIB for the Internet Protocol

RFC 5101 - Specification of the IP Flow Information Export (IPFIX) Protocol for the Exchange of IP Traffic Flow Information

RFC 6241: NETCONF Configuration Protocol

RFC 6242 Using the NETCONF Protocol over Secure Shell (SSH)

draft-ietf-mpls-lsr-mib-06.txt

draft-ietf-mpls-te-mib-04.txt

draft-ietf-mpls-ldp-mib-07.txt

draft-ietf-isis-wg-mib-05.txt

IANA-IFTType-MIB

IEEE8023-LAG-MIB

draft-ietf-ospf-mib-update-04.txt

Index

B

BOF

- overview
 - compact flash
 - storing log files 335

I

in-band port (no shutdown) 389

in-band port (shutdown) 387

L

Log

- overview 332, 500
 - accounting 349
 - accounting design considerations 365
 - accounting files 365
 - accounting records 349
 - default system log 348
 - destinations 334
 - event control 341
 - event filter policies 344
 - event log entries 345
 - event logs 339
 - event sources 340
 - log files 335
 - log manager 343
 - SNMP trap groups 337
 - syslog 337
- configuring
 - accounting policy 379
 - basic 375, 514
 - command reference
 - file ID commands 414
 - filter commands 414
 - log ID commands 415
 - syslog commands 416
 - event control 380
 - event log 376, 515
 - file ID 378
 - log filter 382

- log types 374
- management tasks 394
- overview 374
- SNMP trap group 383
- syslog target 391

R

replay parameter 385

S

Security

- overview
 - AAA 20
 - accounting 30
 - RADIUS 30
 - TACACS+ 30
 - authentication 21
 - RADIUS 22
 - TACACS+ 25
 - authorization 26
 - 26
 - local 26
 - RADIUS 26
 - TACACS+ 27
 - controls 32
 - encryption 56
 - SSH 50
- configuring
 - accounting 65
 - RADIUS 85
 - TACACS+ 90
 - authentication 62
 - RADIUS 83
 - TACACS+ 88
 - authorization 63
 - RADIUS 84
 - TACACS+ 89
 - basic 66
 - login controls 92
 - management access filters 68

Index

- profiles 76
- SSH 91
- users 77
- encryption 56
- keychains 59
- peer CPM queuing 51
- SSH 50
- VSAAs 49
- SNMP**
 - overview
 - access control 282
 - access groups 283
 - users 284
 - USMs 283
 - views 283
 - architecture 280
 - MIBs 280
 - versions 281
 - configuring
 - access options 295
 - basic 291
 - command reference
 - security commands 299
 - show commands 300, 517
 - system commands 299
 - community strings 293
 - SNMPv1 and SNMPv2 290
 - SNMPv3 290
 - USM community options 297
 - view options 294
 - command reference
 - system commands 299
 - user commands 300