



NSP

Network Services Platform

Release 24.4

System Administrator Guide

3HE-20030-AAAA-TQZZA
Issue 7
November 2024

© 2024 Nokia.

Use subject to Terms available at: www.nokia.com/terms

Legal notice

Nokia is committed to diversity and inclusion. We are continuously reviewing our customer documentation and consulting with standards bodies to ensure that terminology is inclusive and aligned with the industry. Our future customer documentation will be updated accordingly.

This document includes Nokia proprietary and confidential information, which may not be distributed or disclosed to any third parties without the prior written consent of Nokia.

This document is intended for use by Nokia's customers ("You"/"Your") in connection with a product purchased or licensed from any company within Nokia Group of Companies. Use this document as agreed. You agree to notify Nokia of any errors you may find in this document; however, should you elect to use this document for any purpose(s) for which it is not intended, You understand and warrant that any determinations You may make or actions You may take will be based upon Your independent judgment and analysis of the content of this document.

Nokia reserves the right to make changes to this document without notice. At all times, the controlling version is the one available on Nokia's site.

No part of this document may be modified.

NO WARRANTY OF ANY KIND, EITHER EXPRESS OR IMPLIED, INCLUDING BUT NOT LIMITED TO ANY WARRANTY OF AVAILABILITY, ACCURACY, RELIABILITY, TITLE, NON-INFRINGEMENT, MERCHANTABILITY OR FITNESS FOR A PARTICULAR PURPOSE, IS MADE IN RELATION TO THE CONTENT OF THIS DOCUMENT. IN NO EVENT WILL NOKIA BE LIABLE FOR ANY DAMAGES, INCLUDING BUT NOT LIMITED TO SPECIAL, DIRECT, INDIRECT, INCIDENTAL OR CONSEQUENTIAL OR ANY LOSSES, SUCH AS BUT NOT LIMITED TO LOSS OF PROFIT, REVENUE, BUSINESS INTERRUPTION, BUSINESS OPPORTUNITY OR DATA THAT MAY ARISE FROM THE USE OF THIS DOCUMENT OR THE INFORMATION IN IT, EVEN IN THE CASE OF ERRORS IN OR OMISSIONS FROM THIS DOCUMENT OR ITS CONTENT.

Copyright and trademark: Nokia is a registered trademark of Nokia Corporation. Other product names mentioned in this document may be trademarks of their respective owners.

© 2024 Nokia.

Contents

- About this document**.....17
- Part I: NSP administration basics**19
- 1 NSP administration overview**.....21
 - 1.1 What does NSP administration involve?21
 - 1.2 How do I receive product and documentation alerts?21
 - 1.3 How do I view technical-support alerts?.....22
- 2 NSP access and UI administration**25
 - 2.1 What is NSP access administration?25
 - 2.2 How do I enable single-address DR NSP system access?27
 - 2.3 How do I configure NSP system settings?29
 - 2.4 How do I configure alarm-severity colors?30
 - 2.5 How do I configure linked URLs?30
 - 2.6 How do I configure event logging?.....31
 - 2.7 How do I configure an e-mail server for notifications?32
- 3 Map layout**35
 - 3.1 What is the map layout?.....35
 - 3.2 How do I select and move map objects?40
 - 3.3 Workflow: create and configure a physical map layout40
 - 3.4 Workflow: create and configure an IGP map layout41
 - 3.5 How do I create a physical map layout?41
 - 3.6 How do I create an IGP map layout?43
 - 3.7 How do I create a region for a physical map layout?43
 - 3.8 How do I create a region for an IGP map layout?45
 - 3.9 How do I place a region on the map layout?.....46
 - 3.10 How do I create a zone in the map layout?.....47
 - 3.11 How do I associate NEs or routers with a region?48
 - 3.12 How do I enable GEO positioning for NEs and routers?49
 - 3.13 How do I rename a layout?50
 - 3.14 How do I move an object to a specific GEO location?50
 - 3.15 How do I search for objects in the map layout?51
 - 3.16 How do I cancel un-deployed changes to the map layout?.....52
 - 3.17 How do I reset warning messages?52
 - 3.18 What are best practices when using the Map Layout?52

4	Resource pool management	55
4.1	How are resource pools used with programmable functions?	55
4.2	How do I search for a resource pool?	55
4.3	How do I view summary information for a resource pool?	56
4.4	How do I configure an IP address pool?	57
4.5	Why use IPv4 subnet re-purposing?	58
4.6	How do I configure a string pool?	58
4.7	How do I configure an RD-RT pool?	59
4.8	How do I configure a Numeric pool?	60
4.9	What are threshold policies?	61
4.10	How do I configure a threshold policy?	62
4.11	How do I reserve resources?	63
4.12	How do I release a resource?	64
4.13	How do I commit a resource?	65
5	NSP File Server	67
5.1	What is the NSP File Server?	67
5.2	How do I use the NSP File Server?	67
Part II: NSP security administration		73
6	SELinux administration	75
6.1	Overview	75
Deploying SELinux		76
6.2	What is SELinux?	76
6.3	How do I enable SELinux on an NSP deployer host?	77
6.4	How do I enable SELinux in an NSP cluster?	79
6.5	How do I enable SELinux on an NSP Flow Collector?	82
6.6	How do I enable SELinux on an NSP Flow Collector Controller?	84
SELinux for Classic Management		88
6.7	What does enabling NFM-P SELinux involve?	88
6.8	How do I enable SELinux on the NFM-P?	88
6.9	How do I enable SELinux enforcing mode for the NFM-P?	93
SELinux troubleshooting		96
6.10	What does NSP SELinux troubleshooting involve?	96
6.11	How do I switch between SELinux modes on NSP system components?	96
6.12	How do I troubleshoot SELinux on NSP system components?	98
6.13	How do I troubleshoot SELinux on the NFM-P?	100

7	TLS administration	103
7.1	What is NSP TLS?	103
7.2	How do I update the K3s certificate for an NSP deployer host VM?	106
7.3	How do I update the NSP container registry TLS certificate?	107
7.4	How do I replace the internal or external NSP TLS certificate?	108
8	NSP user security	113
	Local user management	113
8.1	What is local user management?	113
8.2	What are the NSP user management requirements and restrictions?	113
8.3	How do I create an NSP local user?	115
8.4	How do I import users and groups from NFM-P?	116
8.5	What are the user password policies?	118
8.6	How do I set global user password requirements?	119
8.7	How do I set global user session limits?	120
8.8	How do I modify a user account?	121
8.9	How do I suspend a local user account?	122
	NSP User Access Control	124
8.10	What is User Access Control?.....	124
8.11	Workflow: Configure User Access Control	126
8.12	How do I configure alarm access using roles?.....	127
8.13	How do I configure a role?	128
8.14	How do I set network resource access levels?	131
8.15	How do I configure a user group?	132
8.16	How do I enable User Access Control?.....	133
8.17	What are NSP operator roles and responsibilities?.....	134
8.18	How do I update the NSP TLS certificate for LDAPS remote authentication?	135
	User session management and logging	137
8.19	What is user session management?	137
8.20	How do I terminate user sessions?	137
8.21	How do I send a message to active users?	138
8.22	How do I view user events?	139
8.23	How do I set the User Activity Log to auto-refresh?	140
8.24	How do I set limits for log event retention?	140
8.25	How do I export activity log events?.....	141

Network resource groups	143
8.26 What are group directories and resource groups?	143
8.27 Workflow: create group directories and resource groups.....	143
8.28 How do I create a group directory?	144
8.29 How do I configure a resource group?	144
8.30 How do I associate a resource group with a group directory?	146
8.31 How do I search for a management object?	146
9 Classic management security	149
Securing NFM-P system access	149
9.1 What is NFM-P security?.....	149
9.2 How do I change an NFM-P main database password in a standalone system?	149
9.3 How do I change an NFM-P main database password in a redundant system?.....	152
9.4 How do I update the supported NFM-P TLS versions and ciphers?	158
NFM-P user security	167
9.5 What is NFM-P user security?.....	167
9.6 How do I manage NFM-P user accounts and groups?	167
9.7 What is user activity logging?.....	172
9.8 How do I configure sample span rule?.....	177
9.9 What is remote NFM-P user access?.....	178
9.10 Sample: how do I configure NFM-P user authentication?	180
9.11 Workflow: configure and manage NFM-P user security	183
9.12 How do I reserve an admin account login?	186
9.13 How do I create a scope of command role?.....	186
9.14 How do I create a scope of command profile?	187
9.15 How do I create a span of control?	188
9.16 How do I create a span of control profile?.....	189
9.17 How do I create a span rule?	189
9.18 How do I create an NFM-P user group?.....	190
9.19 How do I add or remove workspaces for a user group?	192
9.20 How do I create an NFM-P user account?	193
9.21 How do I copy an NFM-P user account?.....	195
9.22 How do I configure global user account and password expiry?	195
9.23 How do I configure the GUI client inactivity timeout?.....	196
9.24 How do I configure the minimum allowable user name length?	197
9.25 How do I configure authentication failure actions?.....	197
9.26 How do I configure suspended account actions?.....	198

9.27	How do I configure automated E-mail notification?	198
9.28	How do I list inactive user accounts?	199
9.29	How do I suspend or reinstate an NFM-P user account?.....	199
9.30	How do I change an NFM-P user password?.....	200
9.31	How do I disable an NFM-P user password?	201
9.32	How do I change the password of the current NFM-P user?	202
9.33	How do I export the local tab preferences of one or more users?	202
9.34	How do I assign local tab preferences to users?	203
9.35	How do I send a broadcast message to GUI clients?	204
9.36	How do I view and manage the active GUI client sessions?.....	205
9.37	How do I disconnect an XML API JMS client connection or remove a durable subscription?.....	205
9.38	How do I view the user activity log?	206
9.39	How do I view the user activity associated with an object?.....	208
9.40	How do I change the maximum number of concurrent NFM-P admin operator positions?.....	209
9.41	How do I configure the number of allowed client sessions for a client delegate server?	210
9.42	How do I enable secure access for remote LDAP users?	211
9.43	How do I enable remote user authorization via RADIUS?	212
9.44	How do I enable remote user authorization via TACACS+?	215
9.45	How do I configure NFM-P remote user authentication?	217
9.46	How do I change the NFM-P Task Manager settings?.....	219
9.47	How do I export all workspaces and local tab preferences?	221
9.48	How do I import workspaces and local tab preferences?.....	221
10	Classic management NE security	223
10.1	What is NFM-P NE security?.....	223
10.2	What are RADIUS, TACACS+, and LDAP?	224
10.3	What is device SSH security?	225
10.4	How do I restore support for disabled NE SSH algorithms?	225
10.5	What are CPM filters and traffic management?	228
10.6	What is DoS protection?	229
10.7	What is DDoS protection?.....	230
10.8	What is IP security?	232
10.9	HSM	232
10.10	Workflow: manage NE user and device security.....	233
10.11	How do I configure a MAF?.....	235
10.12	How do I configure a CPM filter?	236
10.13	How do I configure an NE DoS protection policy?	239

10.14	How do I view NE DoS protection violations?	240
10.15	How do I configure an NE DDoS protection policy?.....	241
10.16	How do I configure NE TLS client authentication?	243
10.17	How do I configure NE TLS server authentication?	245
10.18	How do I configure TLS server group list?	247
10.19	How do I configure TLS client group list?.....	248
10.20	How do I configure TLS server signature list?.....	248
10.21	How do I configure TLS client signature list?	249
10.22	How do I configure a site user profile?	250
10.23	How do I configure a user account on a managed device?	251
10.24	How do I configure an NE password policy?.....	252
10.25	How do I configure an LDAP site authentication policy?	253
10.26	How do I configure an NE RADIUS authentication policy?	254
10.27	How do I configure an NE TACACS+ authentication policy?	255
10.28	How do I configure an OmniSwitch RADIUS, TACACS+, or LDAP security authentication policy?	257
10.29	How do I configure device system security settings?.....	257
10.30	How do I configure and manage PKI site security on an NE?	260
10.31	How do I configure a PKI certificate authority profile?	264
10.32	How do I configure the automatic renewal of the PKI certificate?.....	265
10.33	How do I configure a PKI common name list?	266
10.34	How do I configure an Enrollment over Secure Transport profile?.....	267
10.35	How do I add an HSM to the NFM-P?.....	268
10.36	How do I create a file transmission profile?	269
10.37	How do I perform CMPv2 actions?	270
10.38	How do I delete a security policy?.....	273
10.39	How do I manually unlock a user account?.....	274
10.40	How do I clear the password history of a user on a managed device?.....	275
10.41	How do I clear collected statistics on a CPM filter?	275
10.42	How do I manage OCSP cache entries on an NE?.....	277
10.43	What is TCP enhanced authentication?	278
10.44	Workflow: configure TCP enhanced authentication for NEs	279
10.45	How do I configure a global TCP key chain?	280
10.46	How do I distribute global key chains to NEs?	281
10.47	How do I verify the distribution of a global key chain to NEs?	282
10.48	How do I identify differences between a global and local key chain policy or two local key chains?	283

Part III: NSP system administration	285
11 NSP system configuration and management	287
11.1 What is NSP system configuration and management?	287
11.2 How do I add an NSP feature package?	287
11.3 How do I update the NSP system configuration?	287
11.4 How do I change the nsp user password?	290
11.5 How do I change the NSP cluster registry password?	291
11.6 How do I remove the stale NSP allowlist entries?	292
11.7 How do I disable NSP websocket event notifications?	294
11.8 How do I install custom Mistral actions for NSP Workflows?	295
11.9 How do I remove Mistral actions from NSP?	296
11.10 How do I configure a generic mediator?	298
11.11 How do I configure an NSP Workflows trigger framework?	300
11.12 How do I manage NSP Analytics logging?	302
11.13 How do I configure e-mail notification of scheduled Analytics reports?	303
12 NSP cluster administration	305
NSP cluster control and operation	305
12.1 How do I manage NSP clusters?	305
12.2 Workflow: stop and start DR NSP clusters	306
12.3 How do I stop an NSP cluster?	309
12.4 How do I start an NSP cluster?	311
12.5 How do I identify the master node in an NSP cluster?	312
12.6 How do I display the NSP cluster status?	313
12.7 How do I restart a Kubernetes pod?	314
12.8 How do I delete Errored or Evicted pods?	315
NSP cluster lifecycle management	317
12.9 What is Kubernetes cluster lifecycle management?	317
12.10 How do I move a Kubernetes pod to a different node?	317
12.11 How do I add an NSP cluster node?	319
12.12 How do I remove an NSP cluster node?	322
12.13 How do I change NSP system addressing?	325
12.14 How do I back up the NSP deployer host?	325
12.15 How do I restore the NSP deployer host?	327
12.16 How do I replace an NSP cluster node?	329
12.17 How do I restore the NSP Elasticsearch log data?	336

13 NSP cluster database administration	339
13.1 How do I check NSP database synchronization?.....	339
13.2 How do I back up and restore the NSP cluster data?	341
13.3 How do I configure scheduled NSP backups?	342
13.4 How do I back up the NSP cluster databases?	343
13.5 How do I restore the Kubernetes etcd data in an NSP cluster?	347
13.6 How do I restore the NSP cluster databases?	350
14 NSP logging and monitoring	357
14.1 What is System Health?	357
14.2 What are the System Health functions?.....	357
14.3 What is Log Viewer?	358
14.4 What is Grafana?	358
14.5 What is user activity log forwarding?.....	359
14.6 What is the syslog record format for NSP application log forwarding?	360
15 NSP license administration	363
15.1 What is an NSP license?.....	363
15.2 How do I view an NSP license?	363
15.3 How do I apply an NSP license?.....	365
Part IV: NSP disaster recovery	367
16 Disaster recovery for NSP clusters	369
16.1 What are the NSP cluster DR functions?	369
16.2 Workflow: prepare for an NSP DR switchover	370
16.3 How do I identify the NSP cluster DR roles?.....	372
16.4 How do I perform an NSP DR switchover?	373
16.5 How do I display the NSP DR failover setting?	375
16.6 How do I disable NSP DR failovers?.....	376
16.7 How do I enable NSP DR failovers?	377
17 Disaster recovery for NSP components	379
17.1 What are the NSP component DR functions?.....	379
17.2 What is auxiliary database redundancy?	379
17.3 How do I perform an auxiliary database switchover?.....	380
17.4 What is classic management redundancy?.....	381
17.5 What are the NFM-P system redundancy models?.....	382
17.6 What are the NFM-P redundancy functions?	387
17.7 How do I respond to NFM-P redundancy failures?	394

17.8	Workflow: manage NFM-P redundancy	398
17.9	How do I view the NFM-P system redundancy status?	399
17.10	How do I view the NFM-P auxiliary server status?	402
17.11	How do I perform a server activity switch?	404
17.12	How do I configure main database switchover behavior?	405
17.13	How do I perform a main database switchover using the NFM-P client GUI?	406
17.14	How do I perform a main database switchover using a CLI script?	407
17.15	How do I enable or disable automatic database realignment?	408
17.16	How do I configure the IPDR file-transfer policy?	411
Part V: NSP component administration		413
18	MDM administration	415
18.1	What is MDM administration?	415
18.2	How do I install adaptor artifacts that are not supported in the Artifacts view?	415
18.3	How do I enable mTLS on the NSP mediation interface?	418
18.4	How do I enable TLS for telemetry and gNMI on_change support?	419
18.5	How do I manage MDM model definitions?	422
18.6	How do I manage MDM device mappings?	424
18.7	How do I uninstall MDM adaptors?	426
18.8	How do I uninstall MDM adaptor suites?	429
18.9	How do I restart an MDM server?	432
19	NSP Flow Collector / Controller administration	435
19.1	Overview	435
NSP Flow Collector Controller configuration and management		436
19.2	What does NSP Flow Collector Controller administration involve?	436
19.3	How do I start or stop an NSP Flow Collector Controller?	436
19.4	How do I display the NSP Flow Collector Controller status or release level?	437
19.5	How do I open the NSP Flow Collector Controller web UI?	438
19.6	How do I force an NSP Flow Collector Controller to extract a network data snapshot?	439
NSP Flow Collector configuration and management		440
19.7	What does NSP Flow Collector administration involve?	440
19.8	How do I start or stop an NSP Flow Collector?	440
19.9	How do I display the NSP Flow Collector status or release level?	441
19.10	Workflow: configure flow statistics collection	443
19.11	How do I open the NSP Flow Collector web UI?	443
19.12	How do I specify the NEs and MDAs for flow statistics collection	444
19.13	How do I configure the AA flow data persistence?	445

19.14	How do I configure flow statistics aggregation?	445
19.15	How do I configure the transfer of result files?	446
19.16	How do I configure CSV file compression and renaming?	447
19.17	How do I configure an AA Cflowd special-study policy?	448
19.18	How do I configure an AA application or protocol filter?	449
20	NSP auxiliary database administration	451
20.1	What is an NSP auxiliary database?	451
20.2	How do I start an auxiliary database cluster?	453
20.3	How do I stop an auxiliary database cluster?	453
20.4	How do I check the auxiliary database status?	455
20.5	How do I change the samauxdb RHEL user password?	457
20.6	How do I schedule auxiliary database backups?	458
20.7	How do I check the auxiliary database backup status?	459
20.8	How do I perform an auxiliary database backup?	460
20.9	How do I manage auxiliary database backups?	461
20.10	How do I restore an auxiliary database?	463
20.11	How do I change an auxiliary database user password?	470
20.12	How do I change the auxiliary database external IP addresses?	471
20.13	How do I test auxiliary database disk performance?	476
20.14	How do I add an auxiliary database station?	477
20.15	How do I replace an auxiliary database station?	489
20.16	How do I remove an auxiliary database station?	494
20.17	How do I recreate an auxiliary database?	501
20.18	How do I customize auxiliary database tables?	505
20.19	How do I create and manage custom auxiliary database table attributes?	507
21	Classic management administration	511
	NFM-P component administration	511
21.1	Workflow: redundant NFM-P shutdown and restart	511
21.2	How do I start a main server?	515
21.3	How do I stop a main server?	516
21.4	How do I start a main database?	517
21.5	How do I stop a main database?	518
21.6	How do I start an auxiliary server?	518
21.7	How do I stop an auxiliary server?	519

NFM-P administration and management	521
21.8 What is global NFM-P system configuration?	521
21.9 How do I change default text-field and ID ranges?	521
21.10 What are the system preferences configuration procedures?.....	526
21.11 How do I set the NFM-P system preferences?.....	526
21.12 How do I create or configure a format policy?.....	532
21.13 How do I create or configure a range policy?.....	533
21.14 How do I modify the base configuration of all GUI clients?	535
21.15 How do I change the default user file locations on a client delegate server?	536
21.16 How do I enable main database backup file synchronization?	537
21.17 How do I modify the default time period of statistics displayed by the Statistics Manager search filters?.....	539
21.18 How do I modify the default time period of statistics displayed on object properties forms?	540
21.19 How do I enable the preservation of the XML API statistics pool size?.....	541
21.20 How do I configure auto-assigned service ID ranges and uniqueness checking?	543
NFM-P alarm administration	546
21.21 What are alarm thresholds?	546
21.22 What is alarm suppression?	548
21.23 What is the alarm purge algorithm?	549
21.24 What is automatic deletion of correlated alarms?	550
21.25 What is alarm debouncing?.....	550
21.26 How do I filter alarms for XML API clients using the NFM-P GUI?	552
21.27 How do I configure alarm policies?	552
21.28 How do I configure alarm severity and deletion behavior?	554
21.29 How do I configure alarm history logging?	555
21.30 How do I show or hide the alarm Additional Text button?.....	556
21.31 How do I configure alarm debouncing ?.....	557
21.32 How do I configure alarm filters for XML API clients?	557
21.33 How do I reload all alarms from the historical alarm database?	559
21.34 How do I manually promote or demote the severity of an alarm?.....	559
21.35 How do I create an alarm e-mail policy?	560
21.36 How do I optimize alarm event notifications?.....	561
NFM-P license management	563
21.37 What are NFM-P licenses?	563
21.38 How do I view the NFM-P license information?.....	564
21.39 How do I export the NFM-P license information or create a license point inventory?	565
21.40 How do I update the NFM-P license in a standalone deployment?.....	565

21.41	How do I update the NFM-P license in a redundant deployment?	567
21.42	How do I list the backed-up NFM-P license files?	570
21.43	How do I change the default NFM-P license expiry notification date?	571
	NFM-P network management configuration	573
21.44	How do I configure implicitly clearing alarm behavior for node reboots?	573
21.45	How do I configure backup-file retention for unmanaged NEs?	574
21.46	How do I enable alarm reporting to identify duplicate NE system IP addresses?	576
21.47	How do I enable dynamic system IP address updates for 7705 SAR nodes?	578
21.48	How do I enable LSP on-demand resynchronization?	579
21.49	How do I enable debug configuration file reloading on an NE for mirror services?	580
21.50	How do I configure throttle rates for subscriber trap events?	582
21.51	How do I configure the windowing trap delayer option for subscriber table resyncs?	583
21.52	How do I create a default SNMPv2 OmniSwitch user?	585
	Setting NFM-P OLC states	587
21.53	What is an OLC state?	587
21.54	How do I display equipment or service OLC states?	589
21.55	How do I display the OLC state change schedules?	589
21.56	How do I change the OLC state of one or more objects?	590
21.57	How do I lock the OLC state?	591
21.58	How do I schedule an OLC state change?	592
21.59	How do I change the OLC state assigned to one or more alarms?	592
21.60	How do I add the OLC state property to a manually created service template?	593
	NFM-P platform modification and replacement	595
21.61	What is platform modification?	595
21.62	How do I test NFM-P disk performance?	596
21.63	How do I relink the Oracle executable files?	599
21.64	How do I change the IP address or hostname of an NFM-P component?	600
	NFM-P maintenance	602
21.65	What is NFM-P system maintenance?	602
21.66	How do I back up the main database?	607
21.67	How do I collect and store NFM-P log and configuration files?	608
	Daily maintenance	609
21.68	How do I check the main database performance?	609
21.69	How do I back up the NFM-P log and configuration files?	610
	Weekly maintenance	612
21.70	How do I back up and restore NE configuration files?	612
21.71	How do I check the NE scheduled backup status?	612

21.72	How do I back up the NE configuration files?	614
21.73	How do I restore the NE configuration files?.....	615
21.74	Why collect device hardware inventory data?.....	616
21.75	How do I collect port inventory data for a specific managed device?	616
21.76	How do I manage main database audit logs?	618
21.77	How do I reduce the number of Oracle audit logs?	618
21.78	How do I check for performance monitoring statistics collection?.....	618
	Monthly maintenance	620
21.79	Why generate and store a user account list?	620
21.80	How do I generate and store user account data?	620
21.81	How do I test an NFM-P main database restore?	621
21.82	Why check the NFM-P platform performance?	625
21.83	How do I check Windows client station performance?	626
21.84	How do I check network connections between components?.....	627
21.85	How do I measure NFM-P performance?.....	628
21.86	How do I check network management connections?.....	629
21.87	How do I test main server and database redundancy switches?	631
22	Classic management database administration	633
22.1	What is the NFM-P main database?	633
22.2	How do I restore and reinstantiate the NFM-P main database?	634
22.3	Workflow: NFM-P database management	635
22.4	How do I view the main database properties?	637
22.5	How do I configure the Oracle database user lockout threshold?.....	638
22.6	How do I unlock the Oracle database user account?.....	639
22.7	How do I configure Oracle database error monitoring?	641
22.8	How do I configure a size constraint policy?	641
22.9	How do I configure an ageout constraint policy?	643
22.10	How do I create a database file policy to manage database log or core dump files?	644
22.11	How do I configure the statistics data retention period for the main database?.....	646
22.12	How do I back up the main database from the client GUI?	646
22.13	How do I back up the main database from a CLI?	648
22.14	How do I schedule main database backups?.....	651
22.15	How do I restore a standalone main database?.....	652
22.16	How do I restore the primary main database in a redundant system?.....	660
22.17	How do I delete the inactive residential subscriber instances?.....	671
22.18	How do I export an NFM-P main database?	673

22.19	How do I import an NFM-P main database?	676
22.20	How do I reinitiate the main database from the client GUI?	680
22.21	How do I reinitiate the main database from a CLI?	681
A	Classic management scope of command roles and permissions	683
A.1	What are the predefined NFM-P scope of command profiles and roles?.....	683
A.2	What are the permissions assignable to NFM-P scope of command roles?.....	686
A.3	What is the permissions access for NFM-P scope of command roles?	710

About this document

Purpose

The *NSP System Administrator Guide* is intended for operators who have NSP system administrator privileges and need to understand or perform Network Services Platform system management or maintenance. The guide describes how to perform operations for system and component configuration, security, access, and database management.

Scope

The scope of this document is limited to NSP system administration. Readers of the guide are advised to familiarize themselves with the different aspects of the administration process. Each part, chapter, or section describes a specific area of interest or administrative function.

Safety information

For your safety, this document contains safety statements. Safety statements are given at points where risks of damage to personnel, equipment, and operation may exist. Failure to follow the directions in a safety statement may result in serious consequences.

Document support

Customer documentation and product support URLs:

- [Documentation Center](#)
- [Technical support](#)

How to comment

Please send your feedback to [Documentation Feedback](#).

Part I: NSP administration basics

Overview

Purpose

This part of the *NSP System Administrator Guide* introduces the document content and structure, and provides fundamental NSP administration information.

Contents

Chapter 1, NSP administration overview	21
Chapter 2, NSP access and UI administration	25
Chapter 3, Map layout	35
Chapter 4, Resource pool management	55
Chapter 5, NSP File Server	67

1 NSP administration overview

1.1 What does NSP administration involve?

1.1.1 Guide description

The *NSP System Administrator Guide* describes how to perform various NSP management operations as requirements arise, or as directed by technical support.

The guide is written for an NSP operator who has the NSP administrator role assigned to their NSP user group.

1.1.2 NSP administrator responsibilities

An NSP system administrator can manage all NSP functional areas, and is primarily responsible for the following:

- basic, global GUI and operational configuration, as described in this part, [Part I: “NSP administration basics”](#)
- system security, such as TLS configuration and user management, as described in [Part II: “NSP security administration”](#)
- low-level system control and configuration, as described in [Part III: “NSP system administration”](#)
- fault tolerance administration, as described in [Part IV: “NSP disaster recovery”](#)
- control and configuration of ancillary NSP components, as described in [Part V: “NSP component administration”](#)



Note: It is strongly recommended that you perform an administrative procedure in this document only under the guidance of technical support.

1.2 How do I receive product and documentation alerts?

1.2.1 Product alerts

You can subscribe to receive the following types of NSP alerts from the [Alerts Subscription](#) page of the Nokia Support portal:

- Maintenance
- Security
- LifeCycle
- Informational
- Product Change

You must also regularly check your NFM-P platform vendor websites for information about OS patches, updates, and information about software and hardware issues.

1.2.2 Documentation alerts

You can subscribe to receive NSP documentation alerts for the following from the [Documentation Alerts Subscription](#) page of the Nokia Support portal:

- Manuals and Guides
- Release Information
- Technical Notes

1.3 How do I view technical-support alerts?

 **Note:** You must register to view online technical-support information. Contact your Nokia account representative for more information.

1.3.1 Steps

1 _____

Use a browser to open the Nokia [Support portal](#).

2 _____

Click Log in.

3 _____

Enter your user credentials when prompted.

4 _____

Click Products.

5 _____

Specify NSP (Network Services Platform).

 **Note:** The product may be listed as a favorite below the PRODUCT NAME heading.

6 _____

Click Product Alerts.

7 _____

The Alerts for NSP (Network Services Platform) page opens.

8 _____

To view an alert, click on a link in the Alert (PDF) column.

9

To receive an e-mail notification each time an alert is issued, click [Subscribe for Alerts](#). See [1.2.1 "Product alerts" \(p. 21\)](#) for information.

END OF STEPS

2 NSP access and UI administration

2.1 What is NSP access administration?

2.1.1 Introduction

This chapter describes NSP UI access requirements and best practices, and includes procedures for configuring global UI settings and client access.

2.1.2 Browser access to redundant NSP clusters

If you open a browser to the primary NSP URL in a DR deployment, the primary NSP sign-in page opens.

If you open a browser to the standby NSP URL, the browser is redirected to the primary NSP URL if the standby server is operational; otherwise, the browser shows the standby URL as unreachable.

Single-address DR NSP system access

To reduce the number of IP addresses that an NSP operator requires for access to the servers in a DR NSP deployment, you can use a reverse-proxy server to set one IP address for NSP access, regardless of which NSP cluster is active.

See [2.2 “How do I enable single-address DR NSP system access?” \(p. 27\)](#) for proxy-server configuration information.

2.1.3 Best practices for NSP UI access

Some HTTP errors or stalled user sessions can be avoided by adhering to the following best practices:

- The NSP UI is supported on the latest version of Google Chrome. Although other browser types are supported, Chrome is the preferred browser. For information about additional browser support, see the *NSP Planning Guide*.
- It is recommended to use the NSP menu for access to NSP functions, as user-created links to the functions may be broken by a server activity switch or software upgrade.
- Enable cookies in your browser.
- Before signing in as a different user, close all other NSP tabs and sign out of the last tab.
- If multiple NSP tabs are open in one browser, close all other NSP tabs before signing out of the last NSP tab; do not just close the browser.
- Avoid pausing a polling function for more than ten minutes.
- In the event of an NSP server activity switch or shutdown, close all browser tabs; you can sign in again when the server returns to service.

2.1.4 OSS API access to NSP functions

NSP functions publish RESTCONF API URLs for access to managed resources and internal NSP services. Each domain documents the available URLs, which are accessible through a browser to clients such as OSS applications.

See the [Network Developer Portal](#) for information about OSS access to the NSP using RESTCONF APIs.

2.1.5 User documentation access

You can open the NSP Help Center from each NSP view by clicking on the ? icon. The Help Center provides domain-specific help and access to other NSP documentation.

2.1.6 Session connection loss

NSP UI sessions that are terminated by a connection loss may require up to two minutes to reset after the connection is restored. In the interim, the UI may seem to function, but executing a command results in a browser error. The condition persists until an automated system function clears the former session.

2.1.7 Dual management of SR OS devices

NSP supports dual management of SR OS devices running in classic management interface configuration mode. That is, a classic SR OS device can be discovered in both NFM-P and in Device Discovery. The device appears in Device Management, but full NSP functions are not available.

Dual management allows the CLI and FTP credentials for the classic device to be stored in the Device Management data store. This in turn allows the NSP Workflows API to execute CLI commands or perform file transfer operations without the need for the workflow to provide credentials.

For more information about dual management and the NSP Workflows API, see the NSP Workflows actions and functions page on the [Network Developer Portal](#).

Duplicate NEs appearing in NSP views

In a dual-management scenario, MDM uses the system interface IPv6 address as the NE ID if both the IPv4 and IPv6 addresses are set. However, some NSP UI views may display both NE IDs.

To prevent the duplicate display of a dual-managed classic NE, set only the IPv4 or IPv6 system address, as required.

2.1.8 Keyboard-based navigation

You can use the keyboard to navigate and interact with many NSP views. Keyboard navigation allows you to highlight and select interactive elements using keystrokes instead of a pointing device.

The following table lists the accessibility options.

Keystroke	Action
Tab	Advance to next element
Shift + Tab	Return to previous element
Alt + down arrow Option/Alt + down arrow in Apple/OSX	Open pop-up or drop-down menu
Shift + F10 Shift + Fn + F10 in Apple/OSX	Open contextual menu
Ctrl + c Command + c in Apple/OSX	Copy
Ctrl + v Command + v in Apple/OSX	Paste
Enter	Open folder or expandable object such as tile Invoke action on button or menu item
F8 Fn + F8 in Apple/OSX	Move over larger elements or to next page
F5 Shift + Fn + F5 in Apple/OSX	Refresh
Shift + F1 Shift + Fn + F1 in Apple/OSX	Open tool tip
Esc	Close tool tip or menu
Arrow	After tile in matrix selected using Tab key, navigate among tiles Up and down arrows for navigation through items in open contextual or pop-up menu Up and down arrows for navigation between table rows Left and right arrows for navigation across table column headers
Shift + right or left arrow	Reorder data-table columns in selected header

2.2 How do I enable single-address DR NSP system access?

2.2.1 Purpose

Use this procedure to reduce the number of IP addresses a user requires for access to the NSP clusters in a DR NSP deployment.

The procedure describes implementing a reverse proxy that presents only one IP address for system access. The reverse proxy maps the IP address to the appropriate NSP cluster.

i **Note:** The procedure describes using the mod_proxy Apache HTTP module. Using a different proxy agent or mod_proxy configuration is supported but not described. Also, mod_proxy installation is not described. Reverse proxy implementation is specific to a network; the network administrator must determine which implementation is best suited to the management network.

2.2.2 Steps

1 _____

Log in as the root user on the station that is to host the reverse proxy.

2 _____

Open a console window.

3 _____

Open the httpd.conf file in the mod_proxy installation directory using a plain-text editor such as vi.

4 _____

Edit the file to include the following:

```
<VirtualHost *:*>
  <Proxy nspOS://dr>
    BalancerMember http://NSP1
    BalancerMember http://NSP2
  </Proxy>
  ProxyPreserveHost Off
  ProxyPass / nspOS://dr/
  ProxyPassReverse / nspOS://dr/
</VirtualHost>
```

where

NSP1 and NSP2 are the advertised addresses of the NSP clusters

5 _____

Close the console window.

END OF STEPS _____

2.3 How do I configure NSP system settings?

2.3.1 Purpose

Use this procedure to specify the default operating parameters for NSP users.

2.3.2 Steps

1 _____

Log in to NSP as an administrator.

2 _____

On the NSP banner bar, click **User, Settings**.

3 _____

Click **System Settings** on the navigation panel.

4 _____

Configure any of the following global parameters:

- Specify the Polling Time interval for information display updates.
- Set the GUI Language preference.
- Set or modify the Security Statement text that appears on the NSP sign-in page. You can also set an option that requires users to acknowledge the security statement before they can login.
- Select or clear the **Row Color With Severity** option to display or hide the alarm severity color in alarm tables.
- Configure the Time Zone parameter, which affects the timestamp of alarm messages.
- To specify a tile server for map operations, configure the Map Settings parameters:
 - Background Map Layer URL: link to a map available under an open license, in the following format:
`https://tile_server/path/file.png`
 - Background Map Layer Attribution: optional free-form text field for crediting an open license provider for legal purposes

5 _____

Click **Save** when you have finished changing system settings.

END OF STEPS _____

2.4 How do I configure alarm-severity colors?

2.4.1 Purpose

Use this procedure to specify the display colors for alarm levels.

2.4.2 Steps

- 1 _____
Login to NSP as an administrator.
- 2 _____
On the NSP banner bar, click **User, Settings**.
- 3 _____
Click **Alarm Colors** on the navigation panel.
- 4 _____
Under Select Alarm Type, select a severity level and then click on a color tile in the Background Color palette to assign a background color to the severity level. The hexadecimal code for the color appears in the text field beside the palette.
Repeat this step to set custom colors for other alarm severity levels.
- 5 _____
Click **Save** when you have finished changing settings.

END OF STEPS _____

2.5 How do I configure linked URLs?

2.5.1 Purpose

Use this procedure to link up to 20 external URLs that NSP users can open in a new browser tab from the More menu on the NSP banner.

2.5.2 Steps

- 1 _____
Login to NSP as an administrator.
- 2 _____
On the NSP banner bar, click **User, Settings**.

-
- 3 _____
Click **Linked URLs** on the navigation panel.
 - 4 _____
Click **+Add**. The Add Linked URLs form opens.
 - 5 _____
Configure the Name and URL parameters.
 - 6 _____
Click **Add**. The form closes.
 - 7 _____
Click **Save**.
 - 8 _____
To edit a linked URL, click **⋮ More, Edit**.
 - 9 _____
To remove a linked URL, click **⋮ More, Delete**.
 - 10 _____
Click **Save** when you have finished changing settings.

END OF STEPS _____

2.6 How do I configure event logging?

2.6.1 Purpose

Use this procedure to configure the recording of assurance events, or to purge all event records from the database.

 **Note:** Events can be retained for up to 30 days.

2.6.2 Steps

- 1 _____
Login to NSP as an administrator.
- 2 _____
On the NSP banner bar, click **User, Settings**.
- 3 _____

Click **Event Logging Policy** on the navigation panel.

4

Turn on the **Enable event logging** option.

5

To specify how long event records are retained, configure the Retention Time parameter.

6

Click **Delete Stored Events** to remove preexisting log events.

7

Click **Save** when you have finished changing settings.

END OF STEPS

2.7 How do I configure an e-mail server for notifications?

2.7.1 Purpose

Use this procedure to configure connection information for an e-mail server. The e-mail feature may be used to contact NSP users or send alarm notifications as configured in an alarm policy. It can also be used to send an automatic e-mail message to users if their account has been locked.

2.7.2 Steps

1

Sign in to the NSP as an administrator.

2

On the NSP banner bar, click **User, Settings**.

3

Click **E-mail Server Configuration** on the navigation panel.

4

Configure the parameters listed in the following table.

Parameters	Notes
E-mail server address	IPv4 address, hostname, or FQDN of e-mail server An e-mail server with an IPv6 address must use a hostname or FQDN. A hostname or FQDN must be DNS resolvable.

Parameters	Notes
Port number	TCP listening port on e-mail server
E-mail address	Sending e-mail address of e-mail notifications
Username and Password	Authentication credentials for e-mail server
Protocol	E-mail authentication protocol The SMTP option is unsecure. In order to enable secure e-mail notifications using the SMTPS or STARTTLS option, you must: <ul style="list-style-type: none">• Ensure that the required TLS certificate is in the <code>/opt/nsp/NSP-CN-DEP-release-ID/NSP-CN-release-ID/tls/securemail</code> directory.• Run the NSP installer to install the certificate.
Account Lock Email	Enable to send an automated e-mail message to users whose accounts have been locked.
Account Lock Email Subject	The Subject line of the account lockout e-mail message
Account Lock Email Body	The body text of the account lockout e-mail message

5

The **TEST** and **TEST EMAIL TO CURRENT USER** functions are highlighted when the e-mail server configuration is updated.

Perform one or more of the following, as required.

- a. To send a test message to the specified e-mail server and address, click **TEST**.
- b. Click **TEST EMAIL TO CURRENT USER** to send a test message to the currently logged in user. Such an action is recommended to verify successful e-mail delivery before turning on the global Verify Email setting in Users and Security.

6

Click **Save** when you have finished changing settings.

END OF STEPS

3 Map layout

3.1 What is the map layout?

3.1.1 Introduction

The Map Layout function lets administrators specify a common map layout with global location information for NEs and routers, for use in NSP map views.

In the physical map layer, NEs are grouped into geographical regions and zones that are organized against a map background. In the IGP layer, routers are similarly grouped into regions and zones against the same map background. The map can be zoomed out to the regional or continental level, or zoomed in to the city street level, providing precise information about network equipment locations.

The IGP map layer is initially created the first time you select the IGP layer in the Map Layout. It is created based on information derived from the physical layer. Routers in a newly-created IGP layer have corresponding NEs at the same location in the physical layer. Regions and zones in a newly-created IGP layer have corresponding regions and zones at the same location in the physical layer. The regions and zones in the initially-generated IGP layer cannot be deleted and the routers in these regions and zones cannot be excluded. In cases where a router has discovered a subnet, the subnet object is placed in the same region as its designated router. The physical layer must be configured before you can create an IGP layer.

Once the IGP layer is created, you can create additional regions and zones in the IGP layer that do not have corresponding regions and zones in the physical layer. Similarly, you can add routers without corresponding NEs to regions in the IGP layer.

Figure 3-1 Map Layout with regions







Use the controls on the map palette to adjust the behaviour and appearance of the map and objects.

When objects share the same physical location, the map shows a multi-layered icon shaded in blue. To see the co-located objects individually, drag them off of the multi-layered icon.

Table 3-1 Map Palette controls

Fit to Screen	Zoom the map to fit the selected region to available screen area.
Clustering controls	Display or hide region and zone boundaries. Option to move all contained objects when moving a region or zone. Display options for connectors to any NEs/routers that are external to a region or zone: <ul style="list-style-type: none"> • Group external NEs/routers with their immediate parent zone or region; the map displays all connectors to zones or subzones that contain the external NEs. This option shows greater detail. • Group external NEs/routers with their top-level region; the map displays a single connector to the region icon. This option shows less detail.

Table 3-1 Map Palette controls (continued)

 Adjust vertices	Adjust icon size for NEs/routers, zones, and regions. Show/hide text labels for map objects.
 Adjust Links	Show or hide links between NEs/routers, zones, and regions.
 Map View	Turn on Bird's-eye View (shows entire map in small inset). Adjust the opacity of the background map.
 Zoom	Zoom into and out from the map.

3.1.2 Regions

A region is the basic organizational object of a map layout. The layout must contain at least one region, in which NEs/routers are placed. Typically, a region would represent an organizational area of network equipment. Double-clicking a region on the map layout displays its contained NEs/routers and nested zones. Double-clicking a nested zone within a region displays its contained NEs/routers and further-nested zones. Right-clicking a region object and choosing the **Back To** menu option takes you up one level in the map hierarchy.

NEs and routers must be assigned to a region to appear on the map layout. NEs and routers that are not assigned to a region can be manually assigned to one.

Figure 3-2 Exploring region contents - physical layer

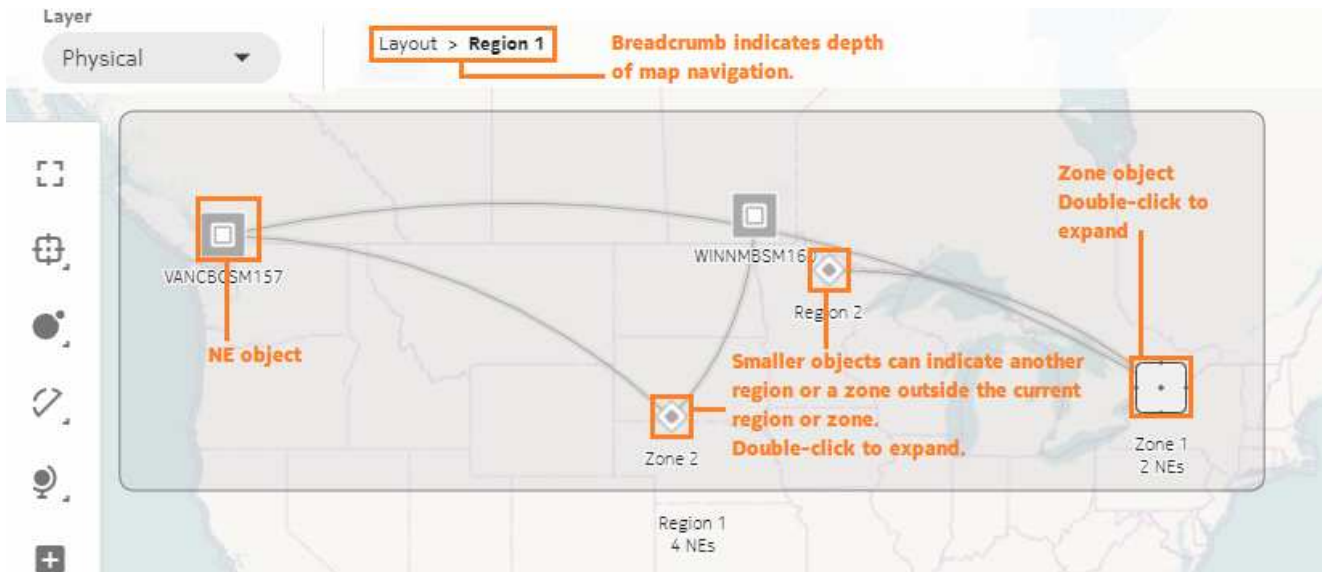
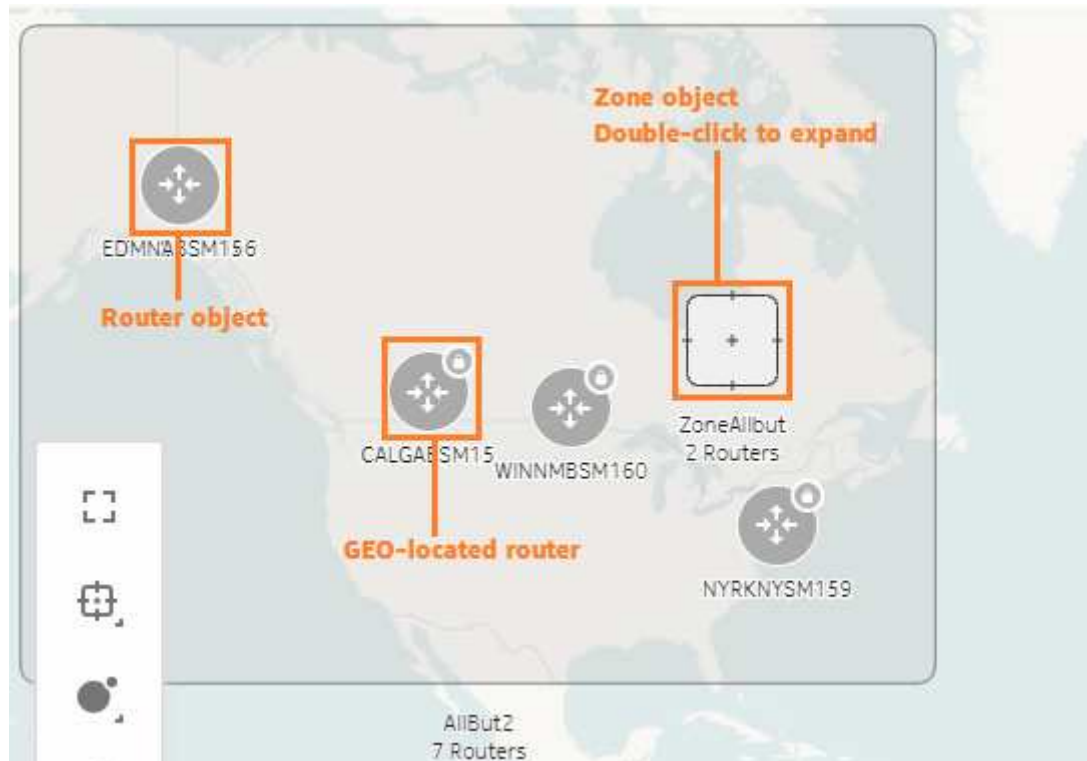

Figure 3-3 Exploring region contents - IGP layer



Right-click on a region to do the following:

- **Open** expands the region to display its NEs/routers and zones
- **Review** open the region in a configuration form in which you can view the contents of the region
- **Edit** open the region in a configuration form in which you can add or remove NEs/routers from the region
- **Delete** removes the region from the map layout, along with all contained NEs/routers and zones

Zones

A region may contain more NEs/routers than can manageably fit on the map layout; for example, in a densely-populated area. You can organize the map layout by sub-grouping the NEs/routers into zones. You can add zones to a region and you can add zones within zones. Double-clicking a zone displays its contained NEs/routers and nested zones. Right-clicking a zone object and choosing the **Back To** menu option takes you up one level in the map hierarchy.

Figure 3-4 Exploring zone contents - physical layer

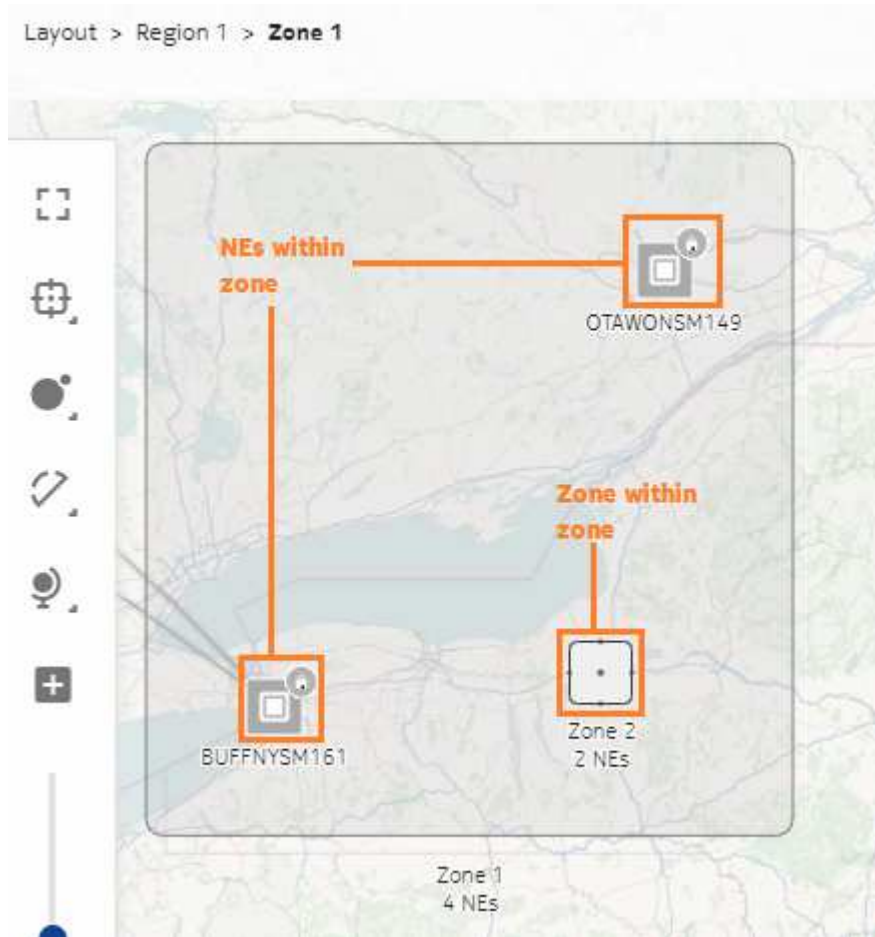

Right-click on a zone to do the following:

- **Open** expands the zone to display its NEs/routers and zones
- **Rename** opens a configuration form in which you can change the zone name
- **Cut** removes the zone from the map and places it on the clipboard. Right-click at another location and choose **Paste** to place the zone.
- **Delete** removes the zone from the map layout, and places all contained NEs/routers in the current Zone or Region

3.1.3 Import regions and zones from NFM-P

You can choose an option to import NFM-P equipment groups to automatically create regions and zones. Equipment group hierarchies and layout information are imported from NFM-P and converted into regions on the map layout. Any nested equipment groups from NFM-P become zones in the map layout.

3.1.4 Import NE location information from NFM-P

You can choose an option to import your NEs' stored GEO location information. Information from either the Coordinates field or the Latitude/Longitude In Degrees fields is used to establish the geographical location of imported NEs.

The following examples reflect the types of supported latitude/longitude string formats:

- N 45 58 23, W 34 56 12
- N37 37' 00 latitude, W122 22' 00 longitude
- N36*39.246' W121*40.121'

You can enable GEO positioning for the map layout after it is created; see [3.12 "How do I enable GEO positioning for NEs and routers?"](#) (p. 49).

3.2 How do I select and move map objects?

3.2.1 Manage map objects

You can select map objects singly by clicking them. Select multiple objects by pressing Ctrl+Click and dragging over the objects. Select additional objects by pressing Ctrl+Click. Selected objects can be moved by dragging them on the map. Additionally, you can move zones and NEs by right-clicking them and using Cut/Paste menu commands.

Press Alt+Click to select and move GEO located (G) NEs.

Be aware of the following limitations when moving map objects:

- You cannot multi-select connector objects. If you select a group of objects that includes a connector, Cut and Paste commands in the right-click menu will not work.
- When you move a connector from a lower level of the map (i.e., from within a region or zone), the position of the connector is not saved. If you want to move a region or zone permanently, you must move it as a region or zone - not as a connector.

3.3 Workflow: create and configure a physical map layout

3.3.1 Steps

1

(Optional) Specify a Background Map Layer URL in the NSP system settings; see [2.3 "How do I configure NSP system settings?"](#) (p. 29).

2

Create a physical layout; see [3.5 "How do I create a physical map layout?"](#) (p. 41).

You can import NFM-P equipment groups to automatically create map regions or zones as part of this step, or you can create an empty layout and add regions one at a time.

3 _____
(Optional) Add regions to the layout; see [3.7 “How do I create a region for a physical map layout?”](#) (p. 43).

4 _____
(Optional) Position regions on the map view; see [3.9 “How do I place a region on the map layout?”](#) (p. 46).

5 _____
(Optional) Create zones to organize NEs within regions; see [3.10 “How do I create a zone in the map layout?”](#) (p. 47).

END OF STEPS _____

3.4 Workflow: create and configure an IGP map layout

i **Note:** The physical map layout layer must be configured before you can create an IGP layer.

3.4.1 Steps

1 _____
Create an IGP layout; see [3.6 “How do I create an IGP map layout?”](#) (p. 43).

2 _____
(Optional) Add regions to the layout; see [3.8 “How do I create a region for an IGP map layout?”](#) (p. 45).

3 _____
(Optional) Position regions on the map view; see [3.9 “How do I place a region on the map layout?”](#) (p. 46).

4 _____
(Optional) Create zones to organize routers within regions; see [3.10 “How do I create a zone in the map layout?”](#) (p. 47).

END OF STEPS _____

3.5 How do I create a physical map layout?

3.5.1 Purpose

Complete this procedure to create a common physical map layout for NSP map views. You can only create one layout.

You can create your map layout with regions and zones, based on imported NFM-P equipment groups, or you can create an empty layout and add regions one at a time.

3.5.2 Steps

1

Open Map Layouts and Groups.

2

On the **Layouts** list on the left-hand side of the GUI, click **+ Add Layout**. The Add New Layout form appears.

3

Specify a name for the layout.

4

Complete one of the following substeps:

1. If you want NE objects to be positioned on the map layout based on the NEs' geographical coordinates, turn on the **GEO NE positioning** option.
NE coordinate information may be stored in the NFM-P database, or directly on individual NEs.
2. If you want to automatically organize NEs into regions or zones, based on equipment groups imported from NFM-P, enable the **Automatically Create Regions** option and enable one of the import options:
 - **Import NFM-P Top Level Equipment Groups Into Regions:** each top level equipment group from NFM-P is created as a region in NSP, with sub-groups created as zones within the regions.
 - **Import NFM-P Top Level Equipment Groups Into Zones:** a single region is created in NSP, with each top level equipment group from NFM-P created as a zone within the region. This option is intended for smaller networks where only one region is needed. Each NFM-P equipment group is imported and converted to a region or zone. NFM-P map coordinates are also imported.

The GEO NE Positioning and Automatically Create Regions options cannot be enabled at the same time. If you choose to import map information from NFM-P, then you cannot enable the GEO NE Positioning option. You can enable GEO positioning for the layout after it is imported.

5

Click **Ok**.

6

The new layout is added to the **Layouts** list.

Click **Map Layout** to view the layout in graphic format.

Complete [3.7 “How do I create a region for a physical map layout?” \(p. 43\)](#) to create and add more regions to the layout.

END OF STEPS

3.6 How do I create an IGP map layout?

3.6.1 Purpose

Complete this procedure to add an IGP map layout to the common map layout for NSP map views. The IGP map is created with information from regions, zones, and NEs in the physical map layout. The resulting IGP map is populated with corresponding regions, zones, and routers. You must have a physical map configured before you can create an IGP map.

3.6.2 Steps

1

Open Map Layouts and Groups.

2

On the **Layouts** list on the left-hand side of the GUI, click on the existing map layout.

You must configure a physical map layout before you can configure an IGP layer; see [3.5 “How do I create a physical map layout?” \(p. 41\)](#).

3

Select IGP from the **Layer** drop--down list. You are taken to the IGP layer view.

4

You are prompted to generate an IGP layer. Click **Ok**.

5

The IGP layout is generated. This process may take several minutes.

Click  **Map Layout** to view the layout in graphic format.

Complete [3.8 “How do I create a region for an IGP map layout?” \(p. 45\)](#) to add more regions to the layout.



END OF STEPS

3.7 How do I create a region for a physical map layout?

3.7.1 Purpose

Complete this procedure to add regions to a physical map layout. You can create multiple regions.

3.7.2 Steps

- 1 _____
Open Map Layouts and Groups.
- 2 _____
In the Map Layout view, select **Physical** from the **Layer** drop-down list.
- 3 _____
On the right-hand side of the GUI, click **+ Add Region**. The Add Region form appears.
You can also perform this function from the  **Map Layout** view.
- 4 _____
Specify a name and description for the region and follow the instructions in the form, clicking **Continue** to navigate through the pages.
- 5 _____
In the Add NEs step, specify NEs for the region, either through inclusion filters or manually:
 - **Filter NEs based on NE attributes.** Select **Attribute Filter** from the drop-down list, click **Add Context Filter** and select an NE attribute. When the new filter appears in the list, click  **Add Filter** and type an attribute value. You can specify multiple attributes.
 - **Add NEs to the region manually.** Select **Manual Entry** from the drop-down list. You can then click **Import** to import a comma-separated list of NE management IP addresses, or click **Add Management IP** and specify an individual NE management IP address.
 - **Filter NEs based on advanced filter expressions.** Select **Advanced Filter** from the drop-down list. Type a filter expression in the **Filter Contents** field, starting with an NE attribute, followed by a Boolean operator and an attribute value. The system suggests possible attributes, operators, and attribute values as you type, and displays error messages in red when an expression is invalid. You can combine attribute-value expressions using AND and OR operators.

When you have finished configuring your filters, click **Continue**. The filter results are listed in the Review and Adjustments form.
- 6 _____
Review the list of NEs to include in the region. If you want to exclude any of the listed NEs, click  **Exclude** on the item. Click **Finish** to save the region.

END OF STEPS

3.8 How do I create a region for an IGP map layout?

3.8.1 Purpose

Complete this procedure to add regions to the IGP map layout. You can create multiple regions.

3.8.2 Steps

1 _____
Open Map Layouts and Groups.

2 _____
In the Map Layout view, select **IGP** from the **Layer** drop-down list.

3 _____
On the left-hand side of the GUI, select a map layout in the Layouts list.

4 _____
On the right-hand side of the GUI, click **+ Add Region**. The Add Region form appears.

5 _____
Specify a name and description for the region and follow the instructions in the form, clicking **Continue** to navigate through the pages.

6 _____
In the Add Routers step, specify Routers for the region, either through inclusion filters or manually:

- **Filter Routers based on Router attributes.** Select **Attribute Filter** from the menu, click **Add Context Filter** and select a Router attribute. When the new filter appears in the list, click **+Add Filter** and type an attribute value. You can specify multiple attributes.
- **Add Routers to the region manually.** Select **Manual Entry** from the menu. You can then click **Import** to import a comma-separated list of Router IDs, or click **Add Router ID** and specify an individual Router ID.
- **Filter Routers based on advanced filter expressions.** Select **Advanced Filter** from the menu. Type a filter expression in the **Filter Contents** field, starting with a Router attribute, followed by a Boolean operator and an attribute value. The system suggests possible attributes, operators, and attribute values as you type, and displays error messages in red when an expression is invalid. You can combine attribute-value expressions using AND and OR operators.

If you are creating a filter to include a large number of routers, it is better to specify an attribute with a range of values to include the routers. Specifying a large number of individual router attribute values linked together with OR operators creates a complex inclusion filter that will burden system resources and possibly cause the import process to fail.

When you have finished configuring your filters, click **Continue**. The filter results are listed in the Review and Adjustments form.

7

Review the list of Routers to include in the region. If you want to exclude any of the listed Routers, click  **Exclude** on the item. Click **Finish** to save the region.

END OF STEPS

3.9 How do I place a region on the map layout?

3.9.1 Purpose

If a newly-created region is GEO located and contains at least one GEO-located NE or router, the region is placed automatically on the map layout. If the region is not GEO-located, it must be manually placed and sized on the map.

 **Note:** If no background map graphic appears in the Map Layout view, it can be configured through the NSP system settings; see [2.3 “How do I configure NSP system settings?”](#) (p. 29).

3.9.2 Steps

1

Open Map Layouts and Groups.

2

In the Map Layout view, from the **Layer** drop-down list, select Physical or IGP, depending on which map layer you want to add a region to.

3

Click  **Map Layout** view to view the layout as a map.

4

Click  **Unplaced Regions**.

A  red flag on the icon indicates that unplaced regions are present. Newly-created regions may take up to 30 seconds to become completely available in the Map Layout view.

5

In the **Unplaced Regions** list, click on a region icon to place it on the map. On the map, click and drag the region into position.

The Move Zone/Region With Contents option must be enabled on the map palette under  **Clustering Controls** before you can add a region to the map.

-
- 6 _____
Double-click the region to expand it and move NE or router icons into position.
 - 7 _____
Click  **Deploy Layout Changes To Common Layout** to save your changes.

END OF STEPS _____

3.10 How do I create a zone in the map layout?

 **Note:** You can create a zone within a region, or within another zone.

3.10.1 Steps

- 1 _____
Open Map Layouts and Groups.
- 2 _____
In the Map Layout view, click on the **Layer** selector and choose Physical or IGP, depending on which map layer you want to add a zone to.
- 3 _____
Click  **Map Layout** view to view the layout as a map.
- 4 _____
Double-click a region on the map. The region expands.
- 5 _____
Complete [Step 6](#) or [Step 7](#) as needed.
- 6 _____
To add a zone to the region, do the following:
 - a. Click **+ Add Zone** on the right-hand side of the GUI. The Add New Zone form appears.
 - b. Specify a name for the zone and click **Ok**. The zone is placed in the region.
Zone names must be unique across the map layout.
 - c. Click and drag the zone into position on the map.
- 7 _____
To add a zone to a zone, do the following:
 - a. Double-click on the zone you want to add a zone to. The zone expands.
 - b. Click **+ Add Zone** on the right-hand side of the GUI. The Add New Zone form appears.

- c. Specify a name for the zone and click **Ok**. The zone is placed in the parent zone.
Zone names must be unique across the map layout.
- d. Click and drag the zone into position on the map.

8

Click  **Deploy Layout Changes To Common Layout** to save your changes.

END OF STEPS

3.11 How do I associate NEs or routers with a region?

3.11.1 Purpose

Use this procedure to search for NEs or routers and associate them with a region in the map layout.

 **Note:** Nokia recommends that each NE/router be associated with only one region.

3.11.2 Steps

1

Open Map Layouts and Groups.

2





Click  **NEs Without a Region** or **Routers Without a Region**.

A  red flag on the icon indicates that NEs or routers with no region are present.

3

The NEs|Routers Without a Region form opens with a list of all objects not associated with a region.

Do one of the following to associate an NE/router with a region:

- Search the list and click on an object you want to associate with a region. Click  **Associate**. A list of available regions is displayed. Click on the region you want to add the object to and click  **Associate** to add it to the region.
- Click  **Add Filter** and type the name of the region you want to add NEs/routers to. The list contents reduce to show only objects not associated with the specified region.
Click on an object in the list and click  **Associate** to add it to the region.

4

Click **Close**.

5

After you have associated NEs or routers with a region, you must go to the  **Map Layout** view and place those objects on the map.

1. Expand the region(s) you associated NEs/routers to.
Newly-associated NEs/routers may take up to 30 seconds to become completely available in the Map Layout view.
2. Drag NEs/routers into position and click  **Deploy Layout Changes To Common Layout** to save your changes.

If you do not place an NE or router after associating it with a region, it is assigned a default location in the region.

END OF STEPS

3.12 How do I enable GEO positioning for NEs and routers?

3.12.1 Purpose

You can enable an option on your map layout to move all NE and router objects into positions on the map, based on each object's stored system coordinates information (latitude/longitude).

GEO positioned NEs and routers appear with Lock badges  on the icons. You must press Alt+Click to select and move GEO positioned objects. Regions containing GEO positioned objects are also flagged.

System coordinates string format

NE and router system coordinates information must be formatted in such a way that NSP recognizes it. The coordinates are configured as GPS latitude and longitude information, in a pair of four-dimensional vectors:

<direction hours minutes seconds>, <direction hours minutes seconds>

where *direction* is one of the four basic values: N, S, E, W, *hours* ranges from 0 to 180 (for latitude) and 0 to 90 for longitude, and *minutes* and *seconds* ranges from 0 to 60. W 122 56 89 is an example of longitude and N 85 66 43 is an example of latitude.

NSP recognizes system coordinates in the following formats:

- N 45 58 23, W 34 56 12
- N45 58' 23 latitude, W34 56' 12 longitude
- N45*58.23' W34*56.12'
- Decimal Degrees (DD) coordinates are supported in the following formats:
 - '-48.3537, -11.7750',
 - '(48.3537, -11.7750)'
 - (48.3537, -11.7750)
 - ('-48.3537, -11.7750')

For signed notation (+/-), the range for Latitude is -180 to +180, and for Longitude is -90 to +90.

3.12.2 Steps

- 1 _____
Open Map Layouts and Groups.
- 2 _____
In the Layouts list, hover over the **⋮ More** icon on a layout item and click  **Edit**.
- 3 _____
In the Edit Layout form, depending on which map layer you are working in, enable either the **GEO NE Positioning** or **GEO Router Positioning** option and click **Ok**.
Objects are positioned on the map according to their stored location data.

END OF STEPS _____

3.13 How do I rename a layout?

3.13.1 Purpose

You can a rename map layout after it has been created.

3.13.2 Steps

- 1 _____
Open Map Layouts and Groups.
- 2 _____
In the Layouts list, hover over the **⋮ More** icon on a layout item and click  **Edit**.
- 3 _____
In the Edit Layout form, type a new name and click **Ok**.

END OF STEPS _____

3.14 How do I move an object to a specific GEO location?

3.14.1 Purpose

You can specify a precise map location information for an individual NE, router, or zone object. You can also restore an object's location to its original location, based on information retrieved from the NSP database.

This function applies only to map layouts with GEO information enabled.

3.14.2 Steps

- 1 _____
Open Map Layouts and Groups.
- 2 _____
Right-click on an object on the map and select **Move To** from the menu.
- 3 _____
Specify **Latitude** and **Longitude** coordinates for the object and click **OK**.
To move an object back to its original location, right-click on the object and select **Restore to NE | Router | Zone GEO Location** from the menu.

END OF STEPS _____

3.15 How do I search for objects in the map layout?

3.15.1 Purpose

Use this procedure to search for an NE, router, region, or zone on the map layout.

3.15.2 Steps

- 1 _____
Open Map Layouts and Groups.
- 2 _____
Click  **Search**.
- 3 _____
Select any of the available object types from the menu. For example:
 - Region name
 - Zone name
 - NE - by name, management IP, or system ID
 - Router - by name or router ID
- 4 _____
Type a search string in the text field. The list populates with near matches as you type.
The list displays a maximum of 50 results. If the item you are trying to find is not in the list, refine your search string to reduce the number of possible matches.

5

Click on an entry in the list to go to the object's location in the map layout.

END OF STEPS

3.16 How do I cancel un-deployed changes to the map layout?

3.16.1 Purpose

Use this procedure to cancel changes you have made to the map layout that have not yet been deployed.

3.16.2 Steps

1

Click the  **Refresh** button and then click **Continue**.

END OF STEPS

3.17 How do I reset warning messages?

3.17.1 Purpose

A variety of warning messages appear as you perform various functions in the Map Layout. When displayed, certain types of warnings give you the option to stop displaying them in future operations. You can reset the warning dialogs so that they appear again.

3.17.2 Steps

1

Open Map Layouts and Groups.

2

Click  **More, Reset All Warning Dialogs** in the upper-left corner of the GUI.

END OF STEPS

3.18 What are best practices when using the Map Layout?

3.18.1 Best practices

It is recommended to observe the following practices when configuring the Map Layout.

3.18.2 Editing the Map Layout

The Map Layout function is best accessed by only a single administrative user at a time, via a single instance of the Map Layout. Simultaneous access by multiple users can result in version conflicts and error messages.

While working in the map layout, if you are unsure if there have been changes to the map layout, click  **Refresh** before continuing to make changes.

3.18.3 Each NE in one region only

Nokia recommends that each NE in the Map Layout be associated with only one region. Placing the same NE in multiple regions can result in inaccurate NE counts in the Unplaced Regions list. Also, duplicate NEs will share the same physical location on the map, regardless of which region they are in.

4 Resource pool management

4.1 How are resource pools used with programmable functions?

4.1.1 Resource pool usage

Resource pools are sets of alphanumeric strings that are used with programmable NSP functions, such as network intents. NSP maintains a list of available resource pools and allows administrators to create and modify pools. Resource pools provide a quick, reusable method to assign IP addresses, numbers, or text strings to ports when you are setting up automated processes.

 **Note:** Resource pools have no relationship with network resource groups. The two have completely different functions in NSP.

You can create and manage the following types of resource pools:

- IP Address
- Numerical
- Text String
- Route Distinguisher or Route Target

You can assign utilization alarm thresholds to resource pools so that Warning, Minor, and Major alarms are generated when resource pool utilization exceeds a prescribed threshold. You assign utilization alarm thresholds to resource pools through threshold policies.

4.1.2 Dashboard view

The Dashboard is the default view of the Resource Management GUI. It displays your resource pools as dashlets. You can select which type of pools are displayed from the drop-down menu. The number of pools displayed in the Dashboard can be controlled by filtering the view based on pool name, scope, description, and threshold policy.

4.2 How do I search for a resource pool?

4.2.1 Steps

1 _____
Open Network Intents.

2 _____
In the upper right-hand corner of the Network Intents GUI, click **More, Open Resource Management**.

The Resource Management GUI opens in a separate browser tab.

-
- 3

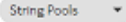
In the Dashboard view, select the type of resource pool you are searching from the drop-down list  .
 - 4

Type a search string in the text field. As you type your string, matching pool objects appear in the dashboard.
 - 5

By default, four searchable pool attributes are enabled. Your search string matches pool objects against any of those attributes.

To narrow the scope of your search, click  **Remove Attribute** on attributes you don't want to search under.

To add a searchable attribute, click  **Add Filter** and select an attribute from the menu.
 - 6

If you enable the **Equals** option, the search only returns pool objects with attribute strings that *exactly match* your search string. If the option is disabled, the search returns pool objects that contain your search string as *part of* an attribute string.

The selection of resource pool dashlets in the dashboard is updated dynamically as you specify a search string, and as you specify filter attributes.

END OF STEPS

4.3 How do I view summary information for a resource pool?



4.3.1 Steps

- 1

You examine configuration and utilization details for a resource pool in the Pool Summary view. Open a pool in one of the following ways, depending on the view you are working in.

 - In the Dashboard view, hover over a resource pool object and click **View**.
 - In a resource pool list view, click  **More, View Pool** on a list item.
- 2

The resource pool opens in the Pool Summary view, which displays read-only configuration and utilization data for a resource pool. It also lists reserved resources in the pool.

 - **Reserve a resource:** Click  **Reserve Resource**; see 4.11 “How do I reserve resources?” (p. 63) for information.
 - **Modify the resource pool:** Click  **Edit Pool** and change the pool configuration as needed.
- 3

Click the **Resource Management** breadcrumb to return to the resource pools list.

END OF STEPS

4.4 How do I configure an IP address pool?

4.4.1 Purpose

An IP address pool defines a range of IP addresses that can be applied to specific configurations in NSP programmable functions. The range is defined by an IP mask and an allocation mask.

To support IPv4 subnet repurposing, subnets can be configured with one or more purpose tags.

4.4.2 Steps

1

Open Network Intents.

2

In the upper right-hand corner of the Network Intents GUI, click **More, Open Resource Management**.

The Resource Management GUI opens in a separate browser tab.

3

Select the **IP Pools** view from the drop-down list.

4

Do one of the following:

- **Create a new pool:** Click **+ Add Pool**.
- **Modify an existing pool:** In the pool list, click **Table Row Actions, Update Pool** on a list item.

5

In the Create | Edit IP Pool form, configure the parameters as required.

6

Click **+ Add** on the IPv4 Networks and Masks list or select a list item and click **Table Row Actions, Edit**.

1. Type an IPv4 network/mask length pair in the **IPv4 Mask** field. Use the format **<ip_address>/<bit_length>**.
2. Type a purpose string in the **Purpose** field and click **+ Add**. The purpose string is added to the network/mask pair. You can specify additional purpose strings to support IPv4 subnet re-purposing.

3. Click **Add | Update**.

You are returned to the Create | Edit IP Pool form.

7

To assign a threshold policy to the pool, click in the **Threshold Policy** field and select a policy from the Select Threshold Policy form.

8

Click **Create** or **Update** to save your changes.

END OF STEPS

4.5 Why use IPv4 subnet re-purposing?

4.5.1 Manage address depletion

The networking industry is facing the depletion of un-allocated IPv4 address space. To enable service providers to grow in business, techniques have been introduced to use IPv4 address space more efficiently. While dynamic IP allocation mechanisms like DHCP make it easy to assign new IPv4 addresses to endpoints, it is an operational challenge to update static addresses because all endpoints in the corresponding subnet must be updated accordingly.

The major challenge with traditional resource management is that pools are typically used for one purpose only. Providers would have pools of IPv4 addresses, specific for subscriber host addresses, business services, in-band management, control-plane loopback addresses, transfer networks, management systems, gateway addresses, etc. If operators implement a strategy like using /31 instead of /30 for network interfaces, the freed address space can be used for other purposes. However, only complete address blocks can be taken from one pool and added to another pool.

Under the principle of multi-purpose pools, operators do not need to define dedicated pools for single purposes. Especially for public IPv4 addresses, a single IPv4 pool is sufficient. Every address block inside the pool has purpose tags assigned so that the operator can decide the purpose for each address block. If demand changes over time, the purpose tags can be updated. When address blocks can be assigned multiple purpose tags, they can be used more universally. In addition, purpose tags are only used for new allocations: the user can update the address block purpose without affecting existing reservations or allocations. If all purpose tags are removed from an address block, no new reservations are allocated, providing an efficient method to drain an address block.

4.6 How do I configure a string pool?

4.6.1 Purpose

A String pool defines a template for alpha-numeric values, with a defined syntax, length, and maximum capacity. String pools are applied to specific configurations in NSP programmable functions.

In the event that a string pool reaches maximum utilization, you can modify the string length and maximum capacity of the pool to increase its size.

4.6.2 Steps

- 1 _____
Open Network Intents.
- 2 _____
In the upper right-hand corner of the Network Intents GUI, click **⋮ More, Open Resource Management**.
The Resource Management GUI opens in a separate browser tab.
- 3 _____
Select the **String Pools** view from the drop-down list.
- 4 _____
Do one of the following:
 - **Create a new pool:** Click **+ Add Pool**.
 - **Modify an existing pool:** In the pool list, click **⋮ Table Row Actions, Update Pool** on a list item.
- 5 _____
In the Create | Update String Pool form, configure the parameters as required.
Specify the **Pattern** as a regular expression. **String Length** and **Max Capacity** must be integers.
- 6 _____
To assign a threshold policy to the pool, click in the **Threshold Policy** field and select a policy from the Select Threshold Policy form.
- 7 _____
Click **Create** or **Update** to save your changes.

END OF STEPS _____

4.7 How do I configure an RD-RT pool?

4.7.1 Purpose

A Route Distinguisher-Route Target (RD-RT) pool defines a range of numerical values that can be applied to specific configurations in NSP programmable functions.

In the event that an RD-RT pool reaches maximum utilization, you can decrease the minimum value

and/or increase the maximum value of the pool to increase the pool size.

4.7.2 Steps

- 1 _____
Open Network Intents.
- 2 _____
In the upper right-hand corner of the Network Intents GUI, click **⋮ More, Open Resource Management**.
The Resource Management GUI opens in a separate browser tab.
- 3 _____
Select the **RD-RT Pools** view from the drop-down list.
- 4 _____
Do one of the following:
 - **Create a new pool:** Click **+ Add Pool**.
 - **Modify an existing pool:** In the pool list, click **⋮ Table Row Actions, Update Pool** on a list item.
- 5 _____
In the Create | Edit RD-RT Pool form, configure the parameters as required.
Minimum Value and **Maximum Value** must be integers.
- 6 _____
To assign a threshold policy to the pool, click in the **Threshold Policy** field and select a policy from the Select Threshold Policy form.
- 7 _____
Click **Create** or **Update** to save your changes.

END OF STEPS _____

4.8 How do I configure a Numeric pool?

4.8.1 Purpose

A Numeric pool defines a range of numerical values that can be applied to specific configurations in NSP programmable functions.

In the event that a numeric pool reaches maximum utilization, you can decrease the minimum value and/or increase the maximum value of the pool to increase the pool size.

4.8.2 Steps

- 1 _____
Open Network Intents.

- 2 _____
In the upper right-hand corner of the Network Intents GUI, click **⋮ More, Open Resource Management**.
The Resource Management GUI opens in a separate browser tab.

- 3 _____
Select the **Numeric Pools** view from the drop-down list.

- 4 _____
Do one of the following:
 - **Create a new pool:** Click **+ Add Pool**.
 - **Modify an existing pool:** In the pool list, click **⋮ Table Row Actions, Update Pool** on a list item.

- 5 _____
In the Create | Edit Numeric Pool form, configure the parameters as required.
Minimum Value and **Maximum Value** must be integers.

- 6 _____
To assign a threshold policy to the pool, click in the **Threshold Policy** field and select a policy from the Select Threshold Policy form.

- 7 _____
Click **Create** or **Update** to save your changes.

END OF STEPS _____

4.9 What are threshold policies?

4.9.1 Threshold policies

Threshold policies define a set of numerical thresholds that are used to generate utilization alarms for resource pools. Depending on their intended usage, threshold policies can be configured to define Warning, Minor, and Major alarm thresholds as percentages or integer counts. When you configure a resource pool, you can associate it with a threshold policy.

4.10 How do I configure a threshold policy?

4.10.1 Steps

- 1 _____
Open Network Intents.
- 2 _____
In the upper right-hand corner of the Network Intents GUI, click **⋮ More, Open Resource Management**.
The Resource Management GUI opens in a separate browser tab.
- 3 _____
Select the **Threshold Policies** view from the drop-down list.
- 4 _____
Do one of the following:
 - **Create a new policy:** Click **+ CREATE THRESHOLD POLICY**.
 - **Modify an existing policy:** In the policy list, click **⋮ Table Row Actions, Edit Threshold Policy** on a list item.
- 5 _____
In the Create | Edit Threshold Policy form, configure the parameters as required.
- 6 _____
Select a **Threshold Type** from the drop-down list.
- 7 _____
Configure **Warning**, **Minor**, and **Major** threshold values.
For a Utilization % threshold policy, the threshold values must be percentages, ascending from the Warning to Major levels.
For a Free Count threshold policy, the threshold values must be integers, ascending from the Warning to Major levels.
- 8 _____
Click **CREATE** or **UPDATE** to save your changes.

END OF STEPS _____

4.11 How do I reserve resources?

4.11.1 Purpose

You reserve pool a resource to allocate it for a specific task. You reserve a resource from a resource pool in the Pool Summary view.

4.11.2 Steps

- 1 _____
Open Network Intents.
- 2 _____
In the upper right-hand corner of the Network Intents GUI, click **⋮ More, Open Resource Management**.
The Resource Management GUI opens in a separate browser tab.
- 3 _____
Select a resource pool type from the drop-down list at the top of the GUI.
- 4 _____
In the pools list, double-click the resource pool from which you want to reserve a resource.
The Pool Summary view opens.
- 5 _____
Click **+ Reserve Resource**.
- 6 _____
In the Reserve Resource form, specify the resource **Reference** and **Owner** in their respective fields.
- 7 _____
Enable the **Confirmed** option to indicate that the resources are allocated and in use.
If the Confirmed option is not enabled, the resources are reserved with the implication that they will be in use.
- 8 _____
Specify the resource values you are reserving in the **Reserve Values** field.
You can specify multiple resource values. After typing a value, click **+ Add** to add it to the list.
- 9 _____
Enable the **All Or Nothing** option if you want the resource reservation to go ahead only if all of the specified resources are available to be reserved.

If the All Or Nothing option is disabled, the system reserves only the resources that are available.

10

Click **Submit** to reserve the resources.

END OF STEPS

4.12 How do I release a resource?

4.12.1 Purpose

You release a resource back to a resource pool in the Pool Summary view, based on values in its **Reference** or **Owner** fields.

4.12.2 Steps

1

Open Network Intents.

2

In the upper right-hand corner of the Network Intents GUI, click **More, Open Resource Management**.

The Resource Management GUI opens in a separate browser tab.

3

Select a resource pool type from the drop-down list at the top of the GUI.

4

In the pools list, double-click the resource pool from which you want to release a resource.
The Pool Summary view opens.

5

Click **More, Release By Reference** or **Release By Owner**.

6

Specify a **Reference** or **Owner** string value, as required.

7

Click **Submit**.

END OF STEPS

4.13 How do I commit a resource?

4.13.1 Purpose

Use the Commit Resource command to allocate all available pool resources as a batch, where you need a number of resources but do not need to specify precisely which ones. The Commit Resource command returns resources from whatever is available in the pool. The Commit Resource command is available for Numeric, IP Address, and RD-RT pools.

You commit resources from a resource pool in the Pool Summary view.

4.13.2 Steps

1 _____
Open Network Intents.

2 _____
In the upper right-hand corner of the Network Intents GUI, click **⋮ More, Open Resource Management**.
The Resource Management GUI opens in a separate browser tab.

3 _____
Select a resource pool type from the drop-down list at the top of the GUI.

4 _____
In the pools list, double-click the resource pool from which you want to commit resources.
The Pool Summary view opens.

5 _____
On the resource pool list item, click **⋮ Table Row Actions, Commit Resource**.

END OF STEPS _____

5 NSP File Server

5.1 What is the NSP File Server?

5.1.1 Overview

The NSP File Server is a file import and management utility that facilitates NSP artifact management for NSP functions such as Device Management, Workflows, and Network Intents.

The NSP File Server.

- facilitates file management for NSP functions
- allows you to:
 - navigate between folders and list files
 - create and remove folders
 - import and remove files
 - search for directories and files by name
 - export a directory listing to a file

Typical uses for the File Server include:

- organizing software images for NE upgrades
- managing input for mass operations such as migrations
- NE backup storage
- managing files used for ZTP
- debug and troubleshooting file storage

5.2 How do I use the NSP File Server?

5.2.1 Purpose

Perform this procedure to perform file-management functions using the NSP File Server.

 **Note:** The NSP File Server supports the typical multi-select functions using the Shift and CTRL keys.

5.2.2 Steps

1

From the  **NSP Menu**, select **File Server**.

The left pane displays the Directory List; the content pane, which is adjacent, lists the objects in the selected directory, and the collapsible Info pane at the right side displays information about the currently selected file or directory.

Basic navigation

2

To scroll through a list of directories or files, use either of the following:

- the scroll bar
- the Page Up and Page Down keys
- the up and down cursor keys.

3

To display the content of a directory in the Directory List, click on the directory.

The directory contents are displayed in the content pane.

4

To open a directory in the content pane, double-click on the directory, or click  beside the directory and click **Open Directory**.

5

To collapse or expand the Info pane, click  or  at the right content pane border.

Display operations

6

To filter the list of objects in the content pane, click  beside a column heading and specify the search criteria using Boolean AND and OR operators.

The list is filtered as specified to show only the matching items.

7

To adjust or customize the information display in the content pane, click use the following, as required:

- Clear sorting—reset the sorting criteria to the defaults
- Clear filters—clear all filters that are applied
- Manage columns...—specify which columns are displayed
- Autosize all columns—automatically adjust the column widths to accommodate the information that is displayed
- Compact rows—compress the information display

8

To refresh the display, click  in the window header.

Directory operations

9

To create a directory at the same level as the current directory:

1. Click **+** in the Root Directory List pane.
The Create Root Directory form opens.
2. Specify a directory name.
3. Click **CREATE**. The new directory is added to the Root Directory List.

10

To create a child directory of a listed root directory:

1. Select the directory in the Root Directory List pane or directory list.
2. Click **⋮**, **Create Directory** beside the directory.
The Create Directory form opens.
3. Specify a directory name.
4. Click **CREATE**. The directory is created.

11

To rename a directory:

1. Select the directory in the Directory List.
2. Click **⋮**, **Rename Directory** beside the directory.
The Update Directory Name form opens.
3. Specify a directory name.
4. Click **RENAME**. The directory is renamed.

12

To import a file to the directory:

1. Select the directory in the Directory List.
2. Click **⋮**, **Import File** beside the directory, or click **↗** above the content pane.
A file browser window opens.
3. Click Open. The file is imported to the current directory.

13

To delete a directory:

1. Select the directory in the Directory List.
2. Click **⋮**, **Delete Directory** beside the directory.
The Delete Directory Name form opens.
3. Click **DELETE**. The directory is deleted.

14

To export a list of directory contents to a file:

1. Select the directory in the Directory List.
2. Click , **Export selected**, *format* beside the content-pane header.

The directory listing is saved as a file in your browser downloads folder.

File operations



15

To rename a file:

1. Click , **Rename File** beside the file.
The Update File form opens.
2. Specify a new name.
3. Click **RENAME**. The file is renamed.

16

To import a file to a directory:

1. Select the directory in the Directory List.
2. Click , **Import File** beside the directory, or click  above the content pane.
A file browser window opens.
3. Click Open. The file is imported to the directory.

17

To download a file, click , **Download File** beside the file:

The file is saved in your browser downloads folder.

18

To delete a file:

1. Click , **Delete File** beside the file.
The Delete File form opens.
2. Click **DELETE**. The file is deleted.

19

To view a file:

1. Click , **View File** beside the file.
A File Viewer form opens and displays the file content.
2. When you are finished viewing the content, click OK to close the form.

Using the global search function

20

To search for File Server file or directory by name:



Note: Searches are case-insensitive.

1. Type part or all of the object name in the search window at the top right of the File Server page, and then click .

The Directory List is hidden, and the matching files and directories are listed.

2. As required, click beside an object to choose an action to perform on the object.

Directory object:

- Open Directory—display the directory content
- Create Directory—create a child directory
- Import File—import a file to the directory, as described in [Step 12](#)
- Delete Directory—remove the directory from the File Server

File object:

- Open Parent Directory—open the directory that contains the file
- Import File—import a file to the directory, as described in [Step 16](#)
- Download File—download the file
- Delete File—remove the file from the File Server
- View File—display the file content

3. To close the global search function and return to the File Server home view, click beside the search window.

The search window closes, and the Directory List and content pane are displayed.

END OF STEPS

Part II: NSP security administration

Overview

Purpose

This part of the *NSP System Administrator Guide* describes how to configure and manage NSP platform, user, and network security.

Contents

Chapter 6, SELinux administration	75
Chapter 7, TLS administration	103
Chapter 8, NSP user security	113
Chapter 9, Classic management security	149
Chapter 10, Classic management NE security	223

6 SELinux administration

6.1 Overview

6.1.1 Purpose

This chapter describes how to implement, manage, and troubleshoot SELinux in an NSP deployment.

6.1.2 Contents

6.1 Overview	75
Deploying SELinux	76
6.2 What is SELinux?	76
6.3 How do I enable SELinux on an NSP deployer host?	77
6.4 How do I enable SELinux in an NSP cluster?	79
6.5 How do I enable SELinux on an NSP Flow Collector?	82
6.6 How do I enable SELinux on an NSP Flow Collector Controller?	84
SELinux for Classic Management	88
6.7 What does enabling NFM-P SELinux involve?	88
6.8 How do I enable SELinux on the NFM-P?	88
6.9 How do I enable SELinux enforcing mode for the NFM-P?	93
SELinux troubleshooting	96
6.10 What does NSP SELinux troubleshooting involve?	96
6.11 How do I switch between SELinux modes on NSP system components?	96
6.12 How do I troubleshoot SELinux on NSP system components?	98
6.13 How do I troubleshoot SELinux on the NFM-P?	100

Deploying SELinux

6.2 What is SELinux?

6.2.1 Introduction

For greater system security, you can enable RHEL SELinux on NSP components. SELinux logs user operations in Application Visibility and Control, or AVC messages that are stored in local logs. SELinux has two modes, permissive and enforcing; the support for each is described in [6.2.2 “SELinux support scope” \(p. 76\)](#).

See the RHEL documentation for comprehensive SELinux configuration and implementation information.

i **Note:** The SELinux policies for the NSP product are to be applied only to the NSP product and the RHEL OS packages listed in the *NSP Installation and Upgrade Guide*. Any SELinux denials for other software packages are not the responsibility of Nokia.

SELinux permissive mode

No SELinux policy is enforced in permissive mode, and no operations are denied. However, SELinux does log AVC messages while in permissive mode. AVC messages may be of use for troubleshooting, debugging, and SELinux policy improvements. An AVC message is logged each time a violation occurs.

SELinux enforcing mode

In enforcing mode, SELinux enforces the policies specified in the NSP SELinux configuration, and logs AVC messages as required.

6.2.2 SELinux support scope

The procedures in this section describe enabling SELinux on the following:

- NSP deployer host
- NSP cluster VM
- NSP Flow Collector
- NSP Flow Collector Controller

i **Note:** An NSP auxiliary database supports SELinux only in permissive mode, which is enabled by default.

[“SELinux for Classic Management” \(p. 88\)](#) describes enabling SELinux on the following, which support SELinux enforcing mode:

- NFM-P main server
- NFM-P main database
- NFM-P auxiliary server

6.3 How do I enable SELinux on an NSP deployer host?

6.3.1 Purpose

Perform this procedure to enable SELinux on the NSP deployer host in an NSP cluster.

i **Note:** You must enable permissive mode on the NSP deployer host before you can enable enforcing mode on the NSP deployer host.

i **Note:** You require root user privileges on the NSP deployer host.

i **Note:** A leading # character in a command line represents the root user prompt, and is not to be included in a typed command.

i **Note:** *release-ID* in a file path has the following format:

R.r.p-rel.version

where

R.r.p is the NSP release, in the form *MAJOR.minor.patch*

version is a numeric value

6.3.2 Steps

1 _____
Log in as the root user on the NSP deployer host.

2 _____
Open a console window.

3 _____
Enter the following:
`# cd /opt/nsp/nsp-k8s-deployer-release-ID/tools/selinux/tools/bin ↵`

Check for required OS packages

4 _____
Enter the following:
`# ./selinuxenable.sh -c ↵`
Any missing OS packages required by SELinux are listed.

5 _____
If the message indicates that one or more required SELinux packages are not installed, enter the following:
`# dnf -y install package_1 package_2 ... package_n ↵`
where *package_1 package_2 ... package_n* are the names of the listed packages

The packages are installed.

Enable permissive mode

6

```
# ./selinuxenable.sh -p ↵
```

The SELinux mode is set to permissive.

Apply SELinux labels

7

Enter the following:

```
# cd /opt/nsp/nsp-k8s-deployer-release-ID/tools ↵
```

8

Enter the following:

```
# selinux/installer/bin/nsp-selinux-config.bash ↵
```

The script loads the required AVC policy, `k3s_nsp_domain.pp`, and labels the files and directories named in the policy.

9

Enter the following to back up the system audit logs:

```
# cp /var/log/audit/audit.log* backup_location ↵
```

where `backup_location` is a secure location on a separate station

10

Enter the following to delete the system audit logs and thereby clear the SELinux AVC history:

```
# rm -f /var/log/audit/audit.log* ↵
```

11

Enter the following:

```
# systemctl reboot ↵
```

The station reboots.

After the reboot, the SELinux labels take effect as SELinux runs in targeted permissive mode in the `nsp_domain_t` domain.

12

After the reboot, enter the following to verify that the required processes are running in the `nsp_domain_t` domain:

```
# ps -aefZ | grep -v grep | egrep  
'k3s|harbor|traefik|coredns|provisioner|registry' ↵
```

Process entries like the following are listed:

```
system_u:system_r:nsp_domain_t:s0 process_description
```

13

If any listed entry does not include `nsp_domain_t`, contact technical support for assistance.

14

Enter the following to verify that the policy file is loaded.

```
# semodule -l | grep k3s_nsp_domain ↵
```

The policy file is listed, as shown below:

```
k3s_nsp_domain
```

15

If the `k3s_nsp_domain` policy is not listed, contact technical support for assistance.

16

Close the open console windows.

END OF STEPS

6.4 How do I enable SELinux in an NSP cluster?

6.4.1 Purpose

Perform this procedure to enable SELinux on the member nodes of an NSP cluster.

i **Note:** You must enable permissive mode on all NSP cluster nodes before you can enable enforcing mode on the nodes.

i **Note:** You require root user privileges on each NSP cluster node.

i **Note:** A leading `#` character in a command line represents the root user prompt, and is not to be included in a typed command.

6.4.2 Steps

1

Perform [Step 3](#) to [Step 11](#) on each node in the NSP cluster.

2

Go to [Step 12](#).

3

Log in as the root user on the NSP cluster node.

4 _____
Open a console window.

5 _____
Enter the following:
`# cd /opt/nsp/nsp-deployer/tools/selinux/tools/bin ↵`

Check for required OS packages

6 _____
Enter the following:
`# ./selinuxenable.sh -c ↵`
Any missing OS packages required by SELinux are listed.

7 _____
If the message indicates that one or more required SELinux packages are not installed, enter the following:
`# dnf -y install package_1 package_2 ... package_n ↵`
where *package_1 package_2 ... package_n* are the names of the listed packages
The packages are installed.

Enable permissive mode

8 _____
`# ./selinuxenable.sh -p ↵`
The SELinux mode is set to permissive.

Apply SELinux labels

9 _____
Enter the following:
`#
/opt/nsp/nsp-deployer/tools/selinux/installer/bin/nsp-selinux-config.
bash ↵`
The script loads the required AVC policy, *k8s_nsp_domain.pp*, and labels the files and directories named in the policy.

10 _____
Enter the following to back up the system audit logs:
`# cp /var/log/audit/audit.log* backup_location ↵`
where *backup_location* is a secure location on a separate station

11

Enter the following to delete the system audit logs and thereby clear the SELinux AVC history:

```
# rm -f /var/log/audit/audit.log* ↵
```

Restart NSP cluster

12

Perform [12.3 “How do I stop an NSP cluster?” \(p. 309\)](#) to gracefully shut down the NSP cluster and preserve the cluster data.

13

Enter the following:

```
# systemctl reboot ↵
```

The node reboots.

After the reboot, the SELinux labels take effect as SELinux runs in targeted permissive mode in the `nsp_domain_t` domain.

14

After the reboot, enter the following to verify that the required processes are running in the `nsp_domain_t` domain:

```
# ps -aefZ | egrep 'kube-apiserver | kube-scheduler |  
kube-controller-manager | /usr/local/bin/etcd |  
/usr/local/bin/kube-proxy | /usr/local/bin/kubelet|/kube-state-metrics  
| /usr/bin/kube-controllers' | egrep -v 'grep' ↵
```

Process entries like the following are listed:

```
system_u:system_r:nsp_domain_t:s0 process_description
```

15

If any listed entry does not include `nsp_domain_t`, contact technical support for assistance.

16

Enter the following to verify that the policy file is loaded.

```
# semodule -l | grep k8s_nsp_domain ↵
```

The policy file is listed, as shown below:

```
k8s_nsp_domain
```

17

Start the NSP cluster; perform [12.4 “How do I start an NSP cluster?” \(p. 311\)](#).

18 _____
Close the open console windows.

END OF STEPS _____

6.5 How do I enable SELinux on an NSP Flow Collector?

6.5.1 Purpose

Perform this procedure to enable SELinux on a station that hosts an NSP Flow Collector that is not collocated on a station with an NSP Flow Collector Controller.

i **Note:** You must enable permissive mode on the NSP Flow Collector station before you can enable enforcing mode on the station.

i **Note:** You require root user privileges on the NSP Flow Collector station.

i **Note:** A leading # character in a command line represents the root user prompt, and is not to be included in a typed command.

6.5.2 Steps

1 _____
Log in as the root user on the NSP Flow Collector station.

2 _____
Open a console window.

3 _____
Enter the following:
`# cd /opt/nsp/tools/selinux/tools/bin ↵`

Check for required OS packages

4 _____
Enter the following:
`# ./selinuxenable.sh -c ↵`
Any missing OS packages required by SELinux are listed.

5 _____
If the message indicates that one or more required SELinux packages are not installed, enter the following:
`# dnf -y install package_1 package_2 ... package_n ↵`
where *package_1 package_2 ... package_n* are the names of the listed packages

The packages are installed.

Enable permissive mode

6

```
# ./selinuxenable.sh -p ↵
```

The SELinux mode is set to permissive.

Apply SELinux labels

7

Enter the following:

```
# /opt/nsp/tools/selinux/installer/bin/nsp-selinux-config.bash ↵
```

The script loads the required AVC policy, `fc_nsp_domain.pp`, and labels the files and directories named in the policy.

8

Enter the following to back up the system audit logs:

```
# cp /var/log/audit/audit.log* backup_location ↵
```

where *backup_location* is a secure location on a separate station

9

Enter the following to delete the system audit logs and thereby clear the SELinux AVC history:

```
# rm -f /var/log/audit/audit.log* ↵
```

10

Stop the NSP Flow Collector.

1. Enter the following to switch to the nsp user:

```
# su - nsp ↵
```

2. Enter the following:

```
bash$ /opt/nsp/flow/fc/bin/flowCollector.bash stop ↵
```

The NSP Flow Collector stops.

3. Enter the following to switch back to the root user:

```
bash$ su - ↵
```

11

Enter the following:

```
# systemctl reboot ↵
```

The station reboots.

After the reboot, the SELinux labels take effect as SELinux runs in targeted permissive mode in the `nsp_domain_t` domain.

12

After the reboot, enter the following to verify that the karaf processes are running in the `nsp_domain_t` domain:

```
# ps -aefZ | grep karaf | grep -v grep ↵
```

Process entries like the following are listed:

```
system_u:system_r:nsp_domain_t:s0 process_description
```

13

If any listed entry does not include `nsp_domain_t`, contact technical support for assistance.

14

Enter the following to verify that the policy file is loaded.

```
# semodule -l | egrep 'nsp' ↵
```

The policy file is listed, as shown below:

```
fc_nsp_domain
```

15

If the `fc_nsp_domain` policy is not listed, contact technical support for assistance.

16

Close the open console windows.

END OF STEPS

6.6 How do I enable SELinux on an NSP Flow Collector Controller?

6.6.1 Purpose

Perform this procedure to enable SELinux on a station that hosts:

- only an NSP Flow Collector Controller
- a collocated NSP Flow Collector Controller and Flow Collector

i **Note:** You must enable permissive mode on the NSP Flow Collector Controller station before you can enable enforcing mode on the station.

i **Note:** You require root user privileges on the NSP Flow Collector Controller station.

i **Note:** A leading # character in a command line represents the root user prompt, and is not to be included in a typed command.

6.6.2 Steps

1 _____
Log in as the root user on the NSP Flow Collector Controller station.

2 _____
Open a console window.

3 _____
Enter the following:
`# cd /opt/nsp/tools/selinux/tools/bin ↵`

Check for required OS packages

4 _____
Enter the following:
`# ./selinuxenable.sh -c ↵`
Any missing OS packages required by SELinux are listed.

5 _____
If the message indicates that one or more required SELinux packages are not installed, enter the following:
`# dnf -y install package_1 package_2 ... package_n ↵`
where *package_1 package_2 ... package_n* are the names of the listed packages
The packages are installed.

Enable permissive mode

6 _____
`# ./selinuxenable.sh -p ↵`
The SELinux mode is set to permissive.

Apply SELinux labels

7 _____
Enter the following:
`# /opt/nsp/tools/selinux/installer/bin/nsp-selinux-config.bash ↵`
The script loads the required AVC policy, `fcc_nsp_domain.pp`, and labels the files and directories named in the policy.

8

Enter the following to back up the system audit logs:

```
# cp /var/log/audit/audit.log* backup_location ↵
```

where *backup_location* is a secure location on a separate station

9

Enter the following to delete the system audit logs and thereby clear the SELinux AVC history:

```
# rm -f /var/log/audit/audit.log* ↵
```

10

Stop the NSP Flow Collector Controller.

i **Note:** If the NSP Flow Collector Controller is collocated on a station with an NSP Flow Collector, stopping the NSP Flow Collector Controller also stops the Flow Collector.

1. Enter the following to switch to the nsp user:

```
# su - nsp ↵
```

2. Enter the following:

```
bash$ /opt/nsp/flow/fcc/bin/flowCollectorController.bash stop ↵
```

The NSP Flow Collector Controller stops.

3. Enter the following to switch back to the root user:

```
bash$ su - ↵
```

11

Enter the following:

```
# systemctl reboot ↵
```

The station reboots.

After the reboot, the SELinux labels take effect as SELinux runs in targeted permissive mode in the *nsp_domain_t* domain.

12

After the reboot, enter the following to verify that the karaf processes are running in the *nsp_domain_t* domain:

```
# ps -aefZ | grep karaf | grep -v grep ↵
```

Process entries like the following are listed:

```
system_u:system_r:nsp_domain_t:s0 process_description
```

13

If any listed entry does not include *nsp_domain_t*, contact technical support for assistance.

14

Enter the following to verify that the policy file is loaded.

```
# semodule -l | egrep 'nsp' ↵
```

The policy file is listed, as shown below:

```
fcc_nsp_domain
```

15

If the `fcc_nsp_domain` policy is not listed, contact technical support for assistance.

16

Close the open console windows.

END OF STEPS

SELinux for Classic Management

6.7 What does enabling NFM-P SELinux involve?

6.7.1 Description

6.8 “How do I enable SELinux on the NFM-P?” (p. 88) describes how to enable SELinux on NFM-P components in permissive mode.

When all components are fully operational in permissive mode, you can use 6.9 “How do I enable SELinux enforcing mode for the NFM-P?” (p. 93) to enable enforcing mode on each component, if required.

6.8 How do I enable SELinux on the NFM-P?

6.8.1 Purpose



CAUTION

Service Disruption

Enabling SELinux in a standalone or redundant NFM-P system creates a network management outage. A standalone system requires a full shutdown and restart; a redundant system requires one or more server activity switches that each may cause a brief service interruption.

Perform the procedure only during a scheduled maintenance period of sufficient duration with the guidance of technical support.

Perform this procedure to enable SELinux on the components of an NFM-P system. You must perform the procedure on each main server, main database, and auxiliary server station.

i **Note:** You must enable permissive mode on each component before you can enable enforcing mode on the components.

i **Note:** You require the following user privileges:

- on each main and auxiliary server station — root, nsp
- on each main database station — root

i **Note:** The following RHEL CLI prompts in command lines denote the active user, and are not to be included in typed commands:

- # —root user
- bash\$ —nsp user

6.8.2 Steps

Check for required OS packages

1

Before you can enable SELinux on a station, you must ensure that the required RHEL OS packages are installed.

Perform the following steps on each main server, main database, and auxiliary server station.

1. Log in to the station as the root user.
2. Open a console window.
3. Enter the following:

```
# cd /opt/nsp/nfmp/config/selinux/tools/bin ↵
```

4. Enter the following:

```
# ./selinuxenable.sh -c ↵
```

Any missing OS packages required by SELinux are listed.

5. If the message indicates that one or more required SELinux packages are not installed, enter the following:

```
# dnf -y install package_1 package_2 ... package_n ↵
```

where *package_1 package_2 ... package_n* are the names of the listed packages

The packages are installed.

Close client sessions

2

Close the open NFM-P GUI and XML API client sessions, as required.

1. Open a GUI client using an account with security management privileges, such as admin.
2. Choose Administration→Security→NFM-P User Security from the main menu. The NFM-P User Security - Security Management (Edit) form opens.
3. Click on the Sessions tab.
4. Click Search. The form lists the open GUI and XML API client sessions.
5. Identify the GUI session that you are using based on the value in the Client IP column.
6. Select all sessions except for the following:
 - the session that you are using
 - the sessions required to monitor the network during a redundant system upgrade
7. Click Close Session.
8. Click Yes to confirm the action.
9. Click Search to refresh the list and verify that only the required sessions are open.
10. Close the NFM-P User Security - Security Management (Edit) form.
11. Close your GUI client.

-
12. Sign out of the NSP UI, if you are signed in.

3

If the NFM-P system is standalone:

1. Perform [Step 5](#) to [Step 10](#) on the main server, main database, and auxiliary server.
2. Go to [Step 13](#).

4

If the NFM-P system is redundant:

1. Perform [Step 5](#) to [Step 12](#) on the standby server complex.
After this step, the initial standby server complex is the new primary complex.
2. Perform [Step 5](#) to [Step 10](#) on the initial primary server complex, which is the new standby server complex.
3. If you want to restore the initial primary and standby roles of the server complexes, go to [Step 11](#). Otherwise, go to [Step 13](#).

Stop system components

5

Stop the main server.

1. Log in to the main server station as the nsp user.
2. Open a console window.
3. Enter the following:

```
bash$ cd /opt/nsp/nfmp/server/nms/bin ↵
```

4. Enter the following:

```
bash$ ./nmserver.bash stop ↵
```

5. Enter the following:

```
bash$ ./nmserver.bash appserver_status ↵
```

The server status is displayed; the server is fully stopped if the status is the following:

```
Application Server is stopped
```

If the server is not fully stopped, wait five minutes and then repeat this step. Do not perform the next step until the server is fully stopped.

6. Enter the following to switch to the root user:

```
bash$ su - ↵
```

6

Stop the Oracle proxy and database services.

1. Log in to the database station as the root user.
2. Open a console window.
3. Enter the following to stop the Oracle proxy:

```
# systemctl stop nfmp-oracle-proxy.service ↵
```

4. Enter the following to stop the main database:

```
# systemctl stop nfmp-main-db.service ↵
```

7

If the system includes one or more auxiliary servers, stop each auxiliary server.

1. Log in to the auxiliary server station as the nsp user.
2. Open a console window.
3. Enter the following:

```
bash$ /opt/nsp/nfmp/auxserver/nms/bin/auxnmserver.bash auxstop ↵
```

The auxiliary server stops.

Enable SELinux permissive mode

8

Enter the following as the root user on each main server, main database, and auxiliary server station:

```
# /opt/nsp/nfmp/config/selinux/tools/bin/selinuxenable.sh -p ↵
```

Apply SELinux labels and reboot

9

Perform the following steps as the root user on each main server, main database, and auxiliary server station.

1. Enter the following:

```
# /opt/nsp/nfmp/config/selinux/installer/bin/nsp-selinux-config.  
bash ↵
```

2. Enter the following to back up all system audit logs:

```
# cp /var/log/audit/audit.log* backup_location ↵
```

where *backup_location* is a secure location on a station outside the NFM-P deployment

3. Enter the following to delete the system audit logs and thereby clear the SELinux AVC history:

```
# rm -f /var/log/audit/audit.log* ↵
```

4. Enter the following:

```
# systemctl reboot ↵
```

The station reboots.

After the reboot, the SELinux labels take effect as SELinux runs in targeted permissive mode in the `nsp_domain_t` domain.

Verify system startup

10

After each station is rebooted, verify that the main server, main database, and auxiliary servers are operational.



Note: If any command in a substep indicates that the component is not yet operational, wait one minute and then re-issue the command.

1. Enter the following as the root user on the main database station:

```
# systemctl status nfmp-main-db.service ↵
```

If the command output includes the following, the database is operational:

```
Active: active (running) since time
```

2. Enter the following as the root user on the main database station:

```
# systemctl status nfmp-oracle-proxy.service ↵
```

If the command output includes the following, the database proxy is operational:

```
Active: active (running) since time
```

3. Enter the following as the nsp user on the main server station:

```
bash$ ./nmserver.bash appserver_status ↵
```

If the command output includes the following, the main server is operational:

```
Application Server process is running. See nms_status for more detail.
```

4. On each auxiliary server station, enter the following as the nsp user:

```
bash$ ./auxnmserver.bash auxappserver_status ↵
```

If the command output includes the following, the auxiliary server is operational:

```
Auxiliary Server process is running. See auxnms_status for more detail.
```

Switch redundancy roles

11

If automatic database realignment is not enabled, perform a database switchover.

1. As the nsp user on the main server station, enter the following:

```
bash$ /opt/nsp/nfmp/server/nms/bin/switchoverdb.bash -u username -p password ↵
```

where *username* and *password* are the login credentials of an NFM-P user with the required privilege level and scope of command

The script displays the following confirmation message:

```
The standby database will become the new primary database, and the old primary will become the new standby. Do you want to proceed? (YES/no) :
```

-
2. Enter the following to initiate the switchover:

YES ↵

The NFM-P server initiates a database switchover. Progress is indicated by a rolling display of dots in the console window. The database switchover is complete when the CLI prompt reappears.

12

Enter the following to perform a server activity switch:

```
bash$ /opt/nsp/nfmp/server/nms/bin/nmsserver.bash force_restart ↵
```

The server activity switch begins. The standby main server restarts as the primary main server, and the primary restarts as the standby.

13

Close the open console windows.

END OF STEPS

6.9 How do I enable SELinux enforcing mode for the NFM-P?

6.9.1 Purpose



CAUTION

Potential Security Risk

Enabling SELinux enforcing mode when any AVCs remain unresolved may pose a security risk.

Before you attempt to enable enforcing mode, you must resolve any AVCs associated with the `nsp_domain_t` domain that are raised during a soak period in permissive mode.

It is strongly recommended that the system run in permissive mode for at least seven days with no `nsp_domain_t` AVCs on any NFM-P main server, main database, or auxiliary server.

Perform this procedure to enable SELinux enforcing mode in an NFM-P system.

i **Note:** You must perform the procedure on each component that supports SELinux enforcing mode, as listed in [6.2.2 “SELinux support scope” \(p. 76\)](#).

i **Note:** You must enable permissive mode on each component, as described in [6.8 “How do I enable SELinux on the NFM-P?” \(p. 88\)](#), before you can enable enforcing mode on the components.

i **Note:** You do not need to stop any NFM-P processes in order to switch from permissive to enforcing mode.

i **Note:** You require root user privileges on each station.

 **Note:** A leading # character in a command line represents the root user prompt, and is not to be included in a typed command.

6.9.2 Steps

1 _____
Log in to the component station as the root user.

2 _____
Open a console window.

3 _____
Enter the following:
`# cd /opt/nsp/nfmp/config/selinux/tools/bin ↵`

4 _____
Enter the following to list all system and NSP-domain AVCs:
`# ./settroubleshoot.bash collect-avcs ↵`
The AVCs are listed.

5 _____
If the command returns any NSP-domain AVCs, enter the following:
`# ./settroubleshoot.bash resolve-nsp-avcs my_policy ↵`
where *my_policy* is a file name other than *nsp_domain* that does not include 'module'
A policy module file with a .te extension is created in /opt/nsp/nfmp/config/selinux/tools/bin/tmp/
policy.

6 _____



WARNING

Extreme Security Risk

The policy module file generated in [Step 5](#) must be reviewed by an experienced SELinux user before the file is loaded in a subsequent step, or system security may be seriously compromised.

The reviewer must ensure that the file does not include any entry that may constitute a security risk to your system.

Ensure that the generated policy module file passes a security review.

1. Enlist an experienced SELinux user to review the policy module file.
2. If the review reveals any AVCs that need to be included in the generic NSP SELinux policy, the reviewer must open a support ticket and include the SELinux logs data generated by running the following script:

```
/opt/nsp/nfmp/config/selinux/tools/bin/cgselinuxlogs.sh
```

3. Make note of the policy created in [Step 5](#) in the event that the experienced SELinux user needs to modify or remove the policy in the future. Maintenance of the policy is the responsibility of the SELinux user.

i **Note:** If the review reveals any AVC issues, you must not proceed to the next step until the AVC issues are resolved.

7

Enter the following:

```
# cd /opt/nsp/nfmp/config/selinux/tools/bin/tmp/policy ↵
```

8

Enter the following to create the required policy file:

```
# make ↵
```

A policy file with a .pp extension is created in the current directory.

9

Enter the following to load the policy file:

```
# semodule -i policy.pp ↵
```

where *policy* is the name of the policy file generated in [Step 8](#)

10

Enable enforcing mode.

1. Enter the following:

```
# cd /opt/nsp/nfmp/config/selinux/tools/bin ↵
```

2. # `./selinuxenable.sh -e` ↵

SELinux is enabled in enforcing mode.

11

Enter the following:

```
# getenforce ↵
```

The SELinux mode is displayed.

12

View the command output to verify that SELinux is enabled in enforcing mode.

13

Close the console window.

END OF STEPS

SELinux troubleshooting

6.10 What does NSP SELinux troubleshooting involve?

6.10.1 Description

In the event that a system or component in SELinux enforcing mode has functional issues and an AVC is present, a change to permissive mode, as described in 6.11 “How do I switch between SELinux modes on NSP system components?” (p. 96), may resolve the issue. If enabling permissive mode resolves the issue, and the AVC is in the NSP domain, it is strongly recommended that you raise a support ticket to report the AVC.

6.12 “How do I troubleshoot SELinux on NSP system components?” (p. 98) and 6.13 “How do I troubleshoot SELinux on the NFM-P?” (p. 100) describe further troubleshooting actions that you can pursue to resolve an SELinux issue.

6.11 How do I switch between SELinux modes on NSP system components?

6.11.1 Purpose



CAUTION

Potential Security Risk

Enabling SELinux enforcing mode when any AVCs remain unresolved may pose a security risk.

Before you attempt to enable enforcing mode, you must resolve any AVCs associated with the nsp_domain_t domain that are raised during a soak period in permissive mode.

It is strongly recommended that the system run in permissive mode for at least seven days with no nsp_domain_t AVCs on any NSP component.

Perform this procedure to switch between SELinux permissive and enforcing modes on one or more of the following:

- NSP deployer host
- NSP cluster nodes
- NSP Flow Collector Controller
- NSP Flow Collector



Note: You do not need to stop any NSP processes in order to switch between SELinux modes.



Note: You require root user privileges on a station to switch SELinux modes.



Note: A leading # character in a command line represents the root user prompt, and is not to be included in a typed command.



Note: *release-ID* in a file path has the following format:

R.r.p-rel.version

where

R.r.p is the NSP release, in the form *MAJOR.minor.patch*

version is a numeric value

6.11.2 Steps

1

Log in as the root user on the station.

2

Open a console window.

3

Enter one of the following, depending on the NSP component type:

a. NSP deployer host:

```
# cd /opt/nsp/nsp-k8s-deployer-release-ID/tools/selinux/tools/bin ↵
```

b. NSP cluster node:

```
# cd /opt/nsp/nsp-deployer/tools/selinux/tools/bin ↵
```

c. NSP Flow Collector Controller or Flow Collector:

```
# cd /opt/nsp/tools/selinux/tools/bin ↵
```

4

To switch from permissive to enforcing mode, enter the following:

```
# ./selinuxenable.sh -e ↵
```

The following messages are displayed, and the SELinux mode changes to enforcing:

```
Checking that the required selinux packages are installed.
```

```
Required packages installed
```

```
selinux currently enabled in permissive mode, change to enforcing mode.
```

5

To switch from enforcing to permissive mode, enter the following:

```
# ./selinuxenable.sh -p ↵
```

The following messages are displayed, and the SELinux mode changes to permissive.

```
Checking that the required selinux packages are installed.
```

```
Required packages installed
```

```
selinux currently enabled in enforcing mode, change to permissive mode.
```

6

Close the console window.

END OF STEPS

6.12 How do I troubleshoot SELinux on NSP system components?

6.12.1 Purpose

Perform this procedure to list and resolve any open AVCs on one of the following:

- NSP deployer host
- NSP cluster nodes
- NSP Flow Collector Controller
- NSP Flow Collector
- NSP auxiliary database

i **Note:** You require root user privileges on a station to switch SELinux modes.

i **Note:** A leading # character in a command line represents the root user prompt, and is not to be included in a typed command.

i **Note:** *release-ID* in a file path has the following format:

R.r.p-rel.version

where

R.r.p is the NSP release, in the form *MAJOR.minor.patch*

version is a numeric value

6.12.2 Steps

1

Log in as the root user on the station.

2

Open a console window.

3

Enter one of the following, depending on the NSP component type:

a. NSP deployer host:

```
# cd /opt/nsp/nsp-k8s-deployer-release-ID/tools/selinux/tools/bin ↵
```

b. NSP cluster node:

```
# cd /opt/nsp/nsp-deployer/tools/selinux/tools/bin ↵
```

c. NSP Flow Collector Controller, Flow Collector, or auxiliary database:

```
# cd /opt/nsp/tools/selinux/tools/bin ↵
```

4

To switch from permissive to enforcing mode, enter the following:

```
# ./settroubleshoot.bash collect-avcs ↵
```

The following messages are displayed:

```
Generating RAW AVC file...  
+ Total Number of distinct AVCs: n  
  + Number of AVCS related to nsp_domain: n
```

5

If the number of `nsp_domain` AVCs is zero, go to [Step 9](#).

6

Enter the following to generate an AVC list file:

```
# ./settroubleshoot.bash resolve-nsp-avcs AVC_list ↵
```

where `AVC_list` is a name to assign to the generated file

The following messages are displayed, and an AVC list file with a `.te` extension is created in the directory described in the messages:

```
Generating RAW AVC file...  
nsp_domain_t AVCs present... generating te file  
Generated /path/AVC_list.te file  
IMPORTANT: The /path/tmp/policy/AVC_list/AVC_list.te file generated by  
this script must be reviewed by an experienced SELinux user before  
loading  
You must ensure that the /path/tmp/policy/AVC_list/AVC_list.te file  
does not include entries that may constitute a security risk to your  
system.
```

7



WARNING

Extreme Security Risk

The generated file must be reviewed by an experienced SELinux user before the file is loaded in a subsequent step, or system security may be seriously compromised.

The reviewer must ensure that the file does not include any entry that may constitute a security risk to your system.

Enlist an experienced SELinux user to review the AVC list file.

8

If the review reveals any AVCs that need to be included in the generic NSP SELinux policy, perform the following steps.

1. Enter the following to capture the local SELinux log files for further analysis by Nokia:

```
# ./cgsselinuxlogs ↵
```

Messages like the following are displayed:

```
Creating log file... /path/selinux
```

```
Deleting previous generated selinux logs in /path/selinux
```

```
Running selinux_capture_logs.sh, please wait (have patience..).
```

```
...
```

```
Log files going to directory /path/selinux
```

```
.  
.
.
```

Provide the following to Nokia for review:

```
/tmp/nspselinux/selinuxLogsselinux-station_descriptor-timestamp.  
tar.gz
```

2. Direct the SELinux user to make note of the generated file in the event that the policy requires modification in the future.

Note: Maintenance of the policy is the responsibility of the SELinux user.

3. Direct the SELinux user to open a Nokia support ticket that includes the generated `/tmp/nspselinux/selinuxLogsselinux-station_descriptor-timestamp.tar.gz` file.

9

Close the console window.

END OF STEPS

6.13 How do I troubleshoot SELinux on the NFM-P?

6.13.1 Purpose

Perform this procedure if SELinux enforcing mode is enabled and you suspect that SELinux is affecting NFM-P operation.

 **Note:** The procedure applies only to the NFM-P components that support SELinux enforcing mode, as listed in [6.2.2 “SELinux support scope”](#) (p. 76).

 **Note:** You must perform the procedure on each NFM-P station that has SELinux enforcing mode enabled.

 **Note:** You require root user privileges on each station.

i **Note:** A leading # character in a command line represents the root user prompt, and is not to be included in a typed command.

6.13.2 Steps

1 _____
Log in as the root user on the standalone or primary NFM-P main server station.

2 _____
Open a console window.

3 _____
Enter the following:
`# cd /opt/nsp/nfmp/config/selinux/tools/bin ↵`

4 _____
Switch to SELinux permissive mode.

i **Note:** The NFM-P main server can remain running during the switch from enforcing to permissive mode.

1. Enter the following:
`# ./selinuxenable.sh -p ↵`
2. Enter the following to verify that SELinux is in permissive mode:
`# getenforce ↵`
The SELinux mode is displayed.
3. View the command output to verify that SELinux is enabled in permissive mode.

5 _____
Enter the following to list all system and NSP-domain AVCs:
`# ./settroubleshoot.bash collect-avcs ↵`
The AVCs are listed.

6 _____
If the command returns any NSP-domain AVCs, enter the following:
`# ./settroubleshoot.bash resolve-nsp-avcs my_policy ↵`
where *my_policy* is a file name other than *nsp_domain* that does not include 'module'
A policy module file with a .te extension is created in /opt/nsp/nfmp/config/selinux/tools/bin/tmp/policy.

7



WARNING

Extreme Security Risk

The policy module file generated in [Step 6](#) must be reviewed by an experienced SELinux user before the file is loaded in a subsequent step, or system security may be seriously compromised.

The reviewer must ensure that the file does not include any entry that may constitute a security risk to your system.

Ensure that the generated policy module file passes a security review.

1. Enlist an experienced SELinux user to review the policy module file.
2. If the review reveals any AVCs that need to be included in the generic NSP SELinux policy, the reviewer must open a support ticket and include the SELinux logs data generated by running the following script:

```
/opt/nsp/nfmp/config/selinux/tools/bin/cgselinuxlogs.sh
```

3. Make note of the policy created in [Step 6](#) in the event that the experienced SELinux user needs to modify or remove the policy in the future. Maintenance of the policy is the responsibility of the SELinux user.



Note: If the review reveals any AVC issues, you must not proceed to the next step until the AVC issues are resolved.

8

Enter the following:

```
# cd /opt/nsp/nfmp/config/selinux/tools/bin/tmp/policy ↵
```

9

Enter the following to create the required policy file:

```
# make ↵
```

A policy file with a .pp extension is created in the current directory.

10

Enter the following to load the policy file:

```
# semodule -i policy.pp ↵
```

where *policy* is the name of the policy file generated in [Step 9](#)

11

Close the console window.

END OF STEPS

7 TLS administration

7.1 What is NSP TLS?

7.1.1 NSP TLS administration overview

The NSP uses TLS to secure the following:

- Kubernetes infrastructure elements; see [7.1.2 “Kubernetes infrastructure security”](#) (p. 103)
 - Kubernetes infrastructure of NSP cluster
 - Kubernetes infrastructure of NSP deployer host
 - NSP container registry
- internal NSP subsystems and services; see [7.1.3 “NSP internal TLS”](#) (p. 104)
- external interfaces between NSP components and for client access; see [7.1.4 “NSP external TLS”](#) (p. 104)

The NSP includes a Public Key Infrastructure, or PKI server, to distribute TLS certificates. A PKI server can generate internal and external certificates using private root CA certificates. See the *NSP Installation and Upgrade Guide* for more information about NSP TLS deployment using a PKI server.

You can generate your own TLS certificates. The NSP PKI server can be used as a certificate authority to sign your certificates, or you can use other tools to generate and sign certificates.

Support for deprecated TLS versions

You can choose to use TLS 1.2 or 1.3 by selecting either option for the Protocol Version parameter on the TLS server profile form (see [10.17 “How do I configure NE TLS server authentication?”](#) (p. 245), [Step 3](#)) or on the TLS client profile form (see [10.16 “How do I configure NE TLS client authentication?”](#) (p. 243), [Step 5](#)). External systems such as OSS clients may use older versions, which are deprecated. You can enable the older TLS versions in the NSP for compatibility with such systems.

The `tlsv1ProtocolsEnabled` parameter in the `nsp-config.yml` file enables or disables the support for deprecated TLS versions:

7.1.2 Kubernetes infrastructure security

The NSP Kubernetes infrastructure certificates undergo automatic scheduled renewal, but manual renewal or replacement options are also available; see [“Kubernetes infrastructure certificate replacement”](#) (p. 105) for information.

NSP cluster

The TLS certificates that secure the NSP Kubernetes infrastructure automatically and silently renew monthly.

No alarm is raised regarding the expiry or renewal; however, the renewal action is logged in the `/var/log/messages` file on the NSP cluster host. The following is the starting log entry for a renewal operation:

```
timestamp node1-3 systemd: Starting Renew K8S control plane certificates...
```

NSP deployer host

The NSP automatically renews the Kubernetes infrastructure TLS certificates twice annually, based on an internal schedule; no operator action is required.

NSP container registry

The NSP cluster communication with the NSP container registry for pulling container images and Helm charts is secured using a TLS certificate that you can manually update.

7.1.3 NSP internal TLS

The internal TLS certificate secures the internal NSP processes. For maximum security, an NSP PKI server uses an internally generated private root CA to create the certificate. Consequently, no certificate from any external CA is trusted for access to system processes.

A PKI server generates an internal certificate automatically during initialization. During an NSP system installation or upgrade, the NSP PKI server must be running in order for each component to request and receive an internal certificate, as described in each NSP and NFM-P installation and upgrade procedure.

When you add or replace an NSP system element such as an NSP Flow Collector or an NFM-P component, the PKI server provides an internal certificate during initialization, as described in the component installation procedure.

 **Note:** To reduce complexity, each upgrade procedure instructs you to start the PKI server, regardless of the upgrade conditions.

7.1.4 NSP external TLS

The external TLS certificate secures the NSP interfaces used by clients and external systems. The certificate can be signed by an external CA, or by the private root CA of an NSP PKI server.

7.1.5 Managing NSP TLS certificates

NSP internal or external TLS certificate replacement may be required when:

- a certificate nears or reaches expiry
- a component is added to the NSP system
- an NSP component is replaced
- an NSP component address changes
- responding to a CA or algorithm compromise

[7.4 “How do I replace the internal or external NSP TLS certificate?” \(p. 108\)](#) describes how to replace the internal TLS certificate, the external certificate, or both, in an NSP system.

Kubernetes infrastructure certificate replacement

You can manually update the NSP deployer host certificate, as may be required for security reasons, or, for example, if the NSP deployer host is shut down at the scheduled renewal time. See [7.2 “How do I update the K3s certificate for an NSP deployer host VM?”](#) (p. 106) for information.

You can also manually replace the NSP container registry certificate; see [7.3 “How do I update the NSP container registry TLS certificate?”](#) (p. 107) for information.

Internal certificate replacement

To replace the internal certificate used in an NSP system, you must start the PKI server, enable the NSP to regenerate internal certificates, and then run the installation script.

External certificate replacement

The external certificate replacement method depends on the TLS deployment method:

- Manual—The replacement process is the same as the manual TLS deployment process described in the *NSP Installation and Upgrade Guide*.
- Automated—The following options are available for generating private root-CA-signed certificates.
 - Provide a set of TLS key and certificate files to the PKI server for signing certificate requests from NSP components during deployment or configuration.
 - Start the PKI server without providing a TLS file set. The PKI server prompts the operator for certificate parameters, signs the certificate using the embedded private root CA, and then generates a TLS file set.

i **Note:** Some system conversion or migration operations may include additional TLS configuration requirements; see the *NSP Installation and Upgrade Guide* for more information.

TLS certificate expiry notifications

The NSP checks the expiry date of each TLS certificate during initialization, and every 24 hours thereafter. After an NSP TLS certificate expires, the NSP cluster continues to operate, but functions that depend on secure communication are unavailable.

When a certificate expires or approaches expiry, the NSP raises one of the following server or internal certificate alarms:

- Warning, if the certificate is to expire within 30 days of the current time
- Critical, if the certificate is to expire within 7 days of the current time
- Critical, if the certificate is expired

i **Note:** The NSP raises one alarm per certificate.

i **Note:** The alarms for internal or external NSP certificate expiry do not clear automatically.

i **Note:** No alarm is raised for an expiring or expired NSP Kubernetes infrastructure certificate.

i **Note:** The Days Remaining value in an expiry alarm is based on the number of complete 24-hour periods until the certificate expiry time. If fewer than 24 hours remain until expiry, the

Days Remaining value is zero; however, the NSP does not raise an alarm about the certificate expiry until the next periodic check, 24 hours later.

7.2 How do I update the K3s certificate for an NSP deployer host VM?

7.2.1 Purpose

Under normal operating conditions, the NSP deployer host TLS certificate renews automatically, and no manual action is required. However, if the certificate is corrupt, the auto-renewal fails, or as a regular security exercise, you can use the following steps to update the certificate manually.

i **Note:** You require root user privileges on the NSP deployer host.

i **Note:** *release-ID* in a file path has the following format:

R.r.p-rel.version

where

R.r.p is the NSP release, in the form *MAJOR.minor.patch*

version is a numeric value

7.2.2 Steps

1 _____
Log in as the root user on the NSP deployer host.

2 _____
Open a console window.

3 _____
Enter the following:
`# cd /opt/nsp/nsp-registry-release-ID/bin ↵`

4 _____
Enter the following to update the certificate:
`# ./nspregistryctl update --k3s-cert ↵`
The NSP updates the certificate and creates a new renewal schedule based on the current time.

5 _____
Enter the following to ensure that all pods are running after the certificate update:

i **Note:** The nsp deployer log file is `/var/log/nspdeployerctl.log`.

`# kubectl get pods -A ↵`

The status of each pod is listed; the NSP cluster is operational when each pod STATUS value is Running or Completed.

6

If the cluster fails to become operational after the typical initialization period, record the cluster status and contact technical support.

7

When the cluster is operational, close the console window.

END OF STEPS

7.3 How do I update the NSP container registry TLS certificate?

7.3.1 Purpose



CAUTION

Service Disruption

Performing the procedure restarts the containerd service, which is temporarily service-affecting.

Ensure that you perform the procedure only during a scheduled maintenance window under the guidance of technical support.

Under normal operating conditions, the NSP container registry certificate renews automatically, and no manual action is required. However, if the certificate is corrupt, the auto-renewal fails, or as a regular security exercise, you can use the following steps to update the certificate manually.



Note: You require root user privileges on the NSP deployer host.



Note: *release-ID* in a file path has the following format:

R.r.p-rel.version

where

R.r.p is the NSP release, in the form *MAJOR.minor.patch*

version is a numeric value

7.3.2 Steps

1

Log in as the root user on the NSP deployer host.

2

Open a console window.

3

Enter the following:

```
# cd /opt/nsp/nsp-registry-release-ID/bin ↵
```

-
- 4 _____
- Enter the following to update the certificate:
- ```
./nspregistryctl update -c ↵
```
- The NSP container registry certificate is updated.
- 5 \_\_\_\_\_
- Enter the following:
- ```
# cd /opt/nsp/nsp-k8s-deployer-release-ID/bin ↵
```
- 6 _____
- Enter the following to update the certificate on each NSP cluster member:
- ```
./nspk8sctl update -r ↵
```
- The update is performed, and the containerd service restarts.
- 7 \_\_\_\_\_
- Log in as the root user on the NSP cluster host.
- 8 \_\_\_\_\_
- Open a console window.
- 9 \_\_\_\_\_
- Enter the following to ensure that all system pods are running after the certificate update:
- ```
# kubectl get pods -A ↵
```
- The status of each pod is listed; the NSP cluster is operational when each pod STATUS value is Running or Completed.
- 10 _____
- If the cluster fails to become operational after the typical initialization period, record the cluster status and contact technical support.
- 11 _____
- When the cluster is operational, close the console window.
- END OF STEPS** _____

7.4 How do I replace the internal or external NSP TLS certificate?

7.4.1 Purpose

Perform this procedure to replace the PKI-server-generated TLS certificates, or custom CA TLS certificates, or both, in an NSP system.

 **Note:** You must perform the procedure on each NSP cluster in a DR deployment.

i **Note:** You require root user privileges on each NSP cluster VM in each data center.

i **Note:** *release-ID* in a file path has the following format:

R.r.p-rel.version

where

R.r.p is the NSP release, in the form *MAJOR.minor.patch*

version is a numeric value

7.4.2 Steps

1 _____
Log in as the root user on the NSP deployer host.

2 _____
Open a console window.

3 _____
Configure the NSP to preserve the existing deployment.

1. Open the following file using a plain-text editor such as vi:

`/opt/nsp/NSP-CN-DEP-release-ID/NSP-CN-release-ID/config/nsp-config.yml`

2. Edit the following line in the **platform** section, **kubernetes** subsection to read as shown below:

```
deleteOnUndeploy:false
```

3. Save and close the file.

4 _____
Enter the following to stop the NSP cluster:

i **Note:** If the NSP cluster VMs do not have the required SSH key, you must include the `--ask-pass` argument in the command, as shown in the following example, and are subsequently prompted for the root password of each cluster member:

```
nspdeployerctl --ask-pass uninstall --undeploy
```

```
# /opt/nsp/NSP-CN-DEP-release-ID/bin/nspdeployerctl uninstall  
--undeploy ↵
```

5 _____
If you are changing the deployment, such as adding or removing a component, or changing a component address, update the NSP configuration.

1. Open the following file with a plain-text editor such as vi:

`/opt/nsp/NSP-CN-DEP-release-ID/NSP-CN-release-ID/config/nsp-config.yml`

2. Update the configuration as required.
3. Save and close the file.

6

If you are updating the PKI-server-generated TLS certificates, copy the new CA certificate files to the following directory:

```
/opt/nsp/NSP-CN-DEP-release-ID/NSP-CN-release-ID/tls/ca
```

7

If you are updating the custom-CA-signed TLS certificates, modify the NSP configuration to include the new certificate information.

1. Open the following file with a plain-text editor such as vi:

```
/opt/nsp/NSP-CN-DEP-release-ID/NSP-CN-release-ID/config/nsp-config.yml
```

2. Edit the parameters in the **tls** section, as required.

3. Save and close the file.

8

Enter the following to start the NSP cluster:

i **Note:** If the NSP cluster VMs do not have the required SSH key, you must include the `--ask-pass` argument in the command, as shown in the following example, and are subsequently prompted for the root password of each cluster member:

```
nspdeployerctl --ask-pass install --config --deploy
```

```
# /opt/nsp/NSP-CN-DEP-release-ID/bin/nspdeployerctl install --config --deploy ↵
```

The NSP cluster starts, and the configuration update is put into effect.

9

If you need to update the TLS configuration on NSP components outside the NSP cluster, start the NSP PKI server; see the *NSP Installation and Upgrade Guide for information*.

10

Configure each other NSP component to obtain the updated TLS configuration.

For information about configuring TLS for components such as the NFM-P main/auxiliary servers, NSP Flow Collectors, Flow Collector Controllers, or an auxiliary database, see the *NSP Installation and Upgrade Guide*.

For information about configuring TLS for other components and products such as the WS-NOC, see the specific component or product documentation.

11

If the PKI server is running, enter Ctrl+C to stop the PKI server.

i **Note:** You must not stop the PKI server until each NSP component has obtained the updated certificates from the PKI server.

12

Close the open console windows.

END OF STEPS

8 NSP user security

Local user management

8.1 What is local user management?

8.1.1 Introduction

The NSP uses Keycloak-based OAUTH2 user authentication, which supports locally defined users for NSP access. If the NSP is integrated with NFM-P, you can also import the NFM-P users to the NSP local user database. Remote authentication agents are also supported.

i **Note:** NSP Users and Security supports up to 5000 users.

For all local and remote users, the Users and Security GUI lists information that includes the authentication source, the user creation time, and the most recent login time.

Local user accounts can be used for machine-to-machine interaction, rather than creating user accounts in your corporate user database. They also provide a backup mechanism for cases where NSP cannot communicate with the corporate user database.

i **Note:** The NSP does not support case-sensitive usernames; local and remote usernames are saved in lowercase. Username entry at sign-in is case-insensitive.

8.1.2 Migration from deprecated CAS authentication

i **Note:** Support for the legacy CAS authentication mode is deprecated, and is to end in an upcoming release.

Migration from the legacy CAS authentication mode to OAUTH2 is strongly recommended, and is to be mandatory when CAS support is discontinued. During the migration to an integrated NSP and NFM-P deployment, you can import the NFM-P users to the NSP local user database.

i **Note:** The WS-NOC supports only the legacy CAS authentication.

i **Note:** Unlike CAS, OAUTH2 does not defer authentication to the NFM-P.

See “To migrate from CAS to OAUTH2 NSP user authentication” in the *NSP Installation and Upgrade Guide* for more information.

8.2 What are the NSP user management requirements and restrictions?

8.2.1 Remote user accounts in NSP

Remote users will have a local account instance created in the NSP database. The remote user accounts appear in Users and Security, Users list, flagged as remote users. Remote users continue to use their login credentials, as defined on the remote server. System administrators can edit certain fields of a remote user’s local account instance, including first/last name, description

and email address (see [8.8 “How do I modify a user account?” \(p. 121\)](#)). Remote users are subject to the same global user session limits as locally defined NSP users.

Active Directory

If NSP is configured for remote user authentication with an Active Directory server, the AD users also appear as local accounts in the NSP database. However, AD users are bulk imported to NSP at system startup. The bulk import of AD users into NSP is automatic and cannot be avoided, but customers can manage the scope of the import by defining remote NSP users with a unique distinguished name on the AD server, and limiting the user search scope to that DN only. Refer to the userDn and searchScope parameters in the *NSP Installation and Upgrade Guide*.

LDAP, RADIUS, and TACACS

As LDAP, RADIUS, and TACACS users login to NSP, a local account instance is created in NSP database. Only the remote users that have logged into NSP appear as local instances of those user accounts in Users and Security.

8.2.2 Email verification

When the global Verify Email setting is enabled, new NSP users must complete a verification process on their first login to NSP.

When a new user logs in to NSP for the first time, the login page displays a message, stating that an e-mail has been sent to the user’s e-mail address to verify their account. The user goes to their e-mail account and locates the account verification e-mail message. The user clicks on the URL link in the e-mail message. The NSP login page opens to NSP.

8.2.3 Forgotten passwords

The NSP sign-in page has a Forgot Password option. If a user clicks this option, they are prompted for their username. A message "You should receive an e-mail shortly ..." appears on the sign-in page. In order to ensure that the Forgot Password option works for local users, configure all local user accounts with e-mail addresses. The Forgot Password feature functions only for local NSP users; remote users cannot reset a password through NSP.

8.2.4 User account lockout messaging

The NSP provides the ability to automatically send an e-mail message to users whose accounts have been locked. A user receives an e-mail when they are temporarily or permanently locked out through Brute Force Detection protection mechanisms. Local user accounts must be configured with an e-mail address to be sent lockout messages.

The lockout e-mail function is enabled through the NSP system settings; see [2.7 “How do I configure an e-mail server for notifications?” \(p. 32\)](#). You can specify the Subject line and body text for the e-mail message.

 **Note:** Lockout messages are not sent to users whose accounts have been set to Suspended status by an administrator. That is a separate function.

8.3 How do I create an NSP local user?

8.3.1 Purpose

This procedure describes how to create a local NSP user account. It does not apply to users managed through external databases.

 **Note:** NSP Users and Security supports up to 5000 users.

8.3.2 Steps

1 _____
Open **Users and Security**.

2 _____
Select **Users** from the drop-down list on the toolbar.

3 _____
Click **+ Create User**.

4 _____
In the Create User form, specify user identification information for the account in the Identification section. The **Username** and **User Group** fields are mandatory.

 **Note:** Any uppercase characters in the username are saved as lowercase.

The **Username** value:

- can be 1 to 40 characters long
- cannot include a space
- cannot have a leading or trailing space
- can include only the following special characters:
 - @ (at sign)
 - - (hyphen)
 - _ (underscore)
 - . (period)

5 _____
In the Password section, specify and confirm a password for the user account.

 **Note:** The NSP does not support case-sensitive usernames; local and remote usernames are saved in lowercase. Username entry at sign-in is case-insensitive.

- If you want this password to be temporary, enable the **Force User to Change Password** option. The new user will be forced to change their password when they first login to NSP.
- Enable the **Show Password** option to see the password characters as you type them.

-
- Click on the **Password Requirements** link to view a list of minimum security requirements for the password.

6

Click **Create**.

7

In an NSP deployment that includes the NFM-P, the NFM-P requires a user group with the same name as the NSP user group; otherwise, the NSP user cannot:

- Open an NFM-P client.
- View NSP GUI alarms that quote NFM-P as the source.
- Open some NSP GUI fault-management views.

If your NSP deployment includes the NFM-P, and the NFM-P does not have a user group with the same name as the NSP user group, perform [9.18 “How do I create an NFM-P user group?”](#) (p. 190).

END OF STEPS

8.4 How do I import users and groups from NFM-P?

8.4.1 Purpose

NFM-P users must be imported into the NSP. The Import function migrates all user accounts and user groups from your NFM-P user database into NSP. The imported users become local NSP users. The imported user groups can be assigned roles that provide the users in the groups access to NSP functions and resources.



Note: NSP Users and Security supports up to 5000 users.

Imported NFM-P users require new passwords. Users that have an e-mail address receive a random password by e-mail. Users without an e-mail address are assigned a global default password set by the administrator. Each imported user must change the password during the first login attempt after the import. It is recommended that the NFM-P system administrator assign e-mail addresses to users before the import in order to ensure the greatest security.

Before importing NFM-P users, consider the following requirements and limitations:

- If you intend to use e-mail notification of new user passwords, you must ensure that the NSP e-mail server is configured in NSP system settings, and that e-mail Notifications option is enabled in the NSP system settings.
- If NFM-P is configured with remote identity providers, those identity providers must be configured in nsp.sso section of nsp-config.yml.
- The NFM-P user parameters imported to NSP are: user name, description, user group, account state, and e-mail address.
- All NFM-P user IDs are converted to lowercase upon import. If two NFM-P user IDs are identical except for case, only one of them is imported. You must clean up any duplicate user IDs in NFM-P prior to import to ensure that all users are imported.

- NSP user groups are case sensitive, as are NFM-P user groups. When NFM-P user groups are imported to NSP, they keep uppercase and lowercase characters. For example, if NFM-P has user groups GROUP1, Group1 and group1, all three are imported into NSP.
- Any NFM-P user names that conflict with existing NSP local users are not imported and do not cause any change to local users.
- NSP supports a maximum of 1000 local users. To ensure that only necessary users are included in the migration, clean up your NFM-P user database before importing to NSP.
- NFM-P remote users are not imported into NSP (remote users include NSP, LDAP, RADIUS, and TACACS users that have access to the NFM-P GUI.)
- NSP authentication does not support local and remote user authentication for the same user ID. To preserve the use of a remote user ID, the local user ID must be changed to a unique value.

8.4.2 Steps

- 1 _____
Open **Users and Security**.
- 2 _____
Select **Users** from the drop-down list on the toolbar.
- 3 _____
Click  **More Actions, Import NFM-P Users and Groups**.
- 4 _____
In the Temporary Password for Imported Users form, specify and confirm a global temporary password for all imported users.
The global temporary password is only applied to imported users with no e-mail address.
- 5 _____
Click OK.
The imported users are listed in the Users view. The imported user groups are listed in the User Groups view.
- 6 _____
The NFM-P imported users can now log in to NSP. All imported users will be required to change their password during first login. NFM-P users that have an e-mail address must check their e-mail for their random login password.

 **Note:** In the event that the import fails for certain users or user groups, you can investigate problems in the nspos-tomcat pod logfile at:
`/opt/nsps/os/tomcat/logs/AccessControlApi.log`

END OF STEPS

8.4.3 Post-import considerations

After importing users from NFM-P, be aware of the following requirements and limitations:

- An imported NFM-P user group that had Administrator scope of command in NFM-P must be assigned to a role with administrative privileges in NSP.
- Lawful Intercept (LI) users are imported to NSP with LI privilege. NFM-P LI users cannot be deleted and must remain in NFM-P after import to NSP.
- NFM-P XML SOAP OSS users must remain in NFM-P after import to perform XML SOAP OSS transactions with NFM-P.
- Non-NFM-P XML SOAP OSS users that are imported to NSP can be deleted from NFM-P after import to NSP.
- NFM-P user groups must exist in NFM-P to define user access permissions through span and scope of control profiles.
- New NFM-P XML SOAP OSS users must be created.

8.5 What are the user password policies?

8.5.1 Introduction

When an operator attempts to sign in to the NSP and a password change is required, the new password must conform to the password policy of the authenticating agent, as described in the following table.

Authenticating agent	Requirement
NSP	User password complexity rules are configurable; the following are the default rules. An NSP local-user password must: <ul style="list-style-type: none"> • have at least ten characters • not be the same as the previous three passwords • include at least one of the following special characters () ? ~ ! @ # \$ % & * _ + • include at least one lowercase character • include at least one uppercase character • include at least one digit • not be the username • not equal the e-mail address
NFM-P	When an NFM-P-authenticated user is prompted to change their password during an NSP login attempt, the new password must conform to the NFM-P password requirements. See “NFM-P user security” (p. 167) for the NFM-P password requirements and expiration policy.

Authenticating agent	Requirement
WS-NOC	When a WS-NOC-authenticated user is prompted to change their password during an NSP login attempt, the password must conform to the WS-NOC password requirements, which are described in the Common Functions section of the <i>WS-NOC Administration Guide</i> .
LDAP, RADIUS and TACACS+	A password-change policy is not applied during an NSP user login attempt. If a password change is required, the user must contact the system administrator for information about the LDAP, RADIUS, or TACACS+ password requirements.

8.6 How do I set global user password requirements?

8.6.1 Purpose

The password policy defines global password requirements for local NSP user accounts, including password contents and length, and expiry and reuse limits. The password policy settings apply only to local NSP user accounts. The password policy does not apply to users managed through external databases.

8.6.2 Steps

- 1 _____
Open **Users and Security**.
- 2 _____
Select **Users** from the drop-down list on the toolbar.
- 3 _____
Click **More Actions, Password Policy**.
- 4 _____
In the Password Policy form, configure user password requirements in any of the following ways:

Not Recently Used	Specifies the number of unique password that must be used before the current password can be used again.
Password Expiry	Specifies the number of days a password can be used before it expires.
Special Characters	Specifies the minimum number of special characters that must be used in the password. Allowable special characters are: <code>()@#\$\$%&!*_+~</code>

Uppercase Characters	Specifies the minimum number of uppercase characters that must be used in the password.
Lowercase Characters	Specifies the minimum number of lowercase characters that must be used in the password.
Digits	Specifies the minimum number of numerical characters that must be used in the password.
Minimum Length	Specifies the minimum number of characters that must be used in the password.
Must Not Be Username	Enable this option to prevent the account username from being used as a password.
Must Not Be Email Address	Enable this option to prevent the account e-mail address from being used as a password.

5

Click **Save**.

END OF STEPS

8.7 How do I set global user session limits?

8.7.1 Purpose

You can configure limits for NSP user sessions such as maximum inactivity time, maximum GUI sessions per user, and so on. These configurations are set globally and apply to all users. They cannot be configured per user.

8.7.2 Steps

1

Open **Users and Security**.

2

Select **Users** from the drop-down list on the toolbar.

3

Click **More Actions, Session Settings**.

4

In the Session Settings form, configure user session limits in any of the following ways:

UI Session Inactivity Timeout	The number of minutes of user session inactivity before the user is automatically logged out of NSP ¹ .
--------------------------------------	--

Maximum Session Time	The absolute maximum length of a user session (in minutes) before the user is automatically logged out of NSP.
Maximum Time to Complete Login	The maximum time allowed (in minutes) for a user to complete an NSP login.
Maximum Time to Complete Login Steps	The maximum time allowed (in minutes) for an NSP login sequence that involves multiple steps; for example, if the user must change their password during login.
Maximum UI Sessions Per User	The maximum number of simultaneous GUI sessions per user account. When this parameter is set to zero, the number of sessions per user is unlimited.
Maximum OSS Sessions Per User	The maximum number of simultaneous OSS sessions per user account. When this parameter is set to zero, the number of sessions per user is unlimited.
OSS Access Token Lifespan	The number of minutes before an OSS access token expires.
Verify Email	The user is required to verify their e-mail address at first login or after e-mail address changes.
Forget Password	Provides the user with a "Forgot Password?" login page link. The link prompts the user to start a password reset process. This setting applies only to local users; it does not apply to remote users.

Notes:

1. Some NSP UI views are in continuous communication while in use, and a user session does not become idle as long as the user has that view open. For example, viewing an alarm list.

5 _____

Click **Save**.

END OF STEPS _____

8.8 How do I modify a user account?

8.8.1 Purpose

You can modify all aspects of a local user account, except for the username. You can also change a user's password or compel the user to change their password.

You can modify select parameters on remote user accounts. You cannot change the username or password on a remote user account, nor can you compel a password change.

8.8.2 Steps

1 _____
Open **Users and Security**.

2 _____
Select **Users** from the drop-down list on the toolbar.

3 _____
In the Users list, select the user account you want to modify.

4 _____
On the user account item, click  **Table Row Actions, Edit User**.

5 _____
On the Update User form, make any of the following changes:

- Change the user's **First Name**, **Last Name**, or their **Description** text.
- Set the **Account State** parameter to **Active|Suspended**.
- Assign the user to a different **User Group**.
- Change the user **Email Address**.
- Enable the **Force User To Change Password** option to compel the user to set a new password at their next NSP login.
- To change the user's password yourself, turn on the **Change Password** toggle to make the user account **Password** fields editable. Specify and confirm a new password.

6 _____
Click **Update**.

END OF STEPS _____

8.9 How do I suspend a local user account?

8.9.1 Purpose

You can temporarily suspend an NSP local user account. After suspension, the user will lose access to the NSP system after they logout and login again.

8.9.2 Steps

1 _____
Open **Users and Security**.

2 _____

Select **Users** from the drop-down list on the toolbar.

3 _____

In the Users list, select the user account you want to suspend.

4 _____

On the user account item, click **⋮ Table Row Actions, Edit User**.

5 _____

On the Update User form, set the **Account State** parameter to **Suspended**.

6 _____

Click **Update**.

END OF STEPS _____

NSP User Access Control

8.10 What is User Access Control?

8.10.1 Overview

User Access Control (UAC) is disabled by default in NSP. While UAC is disabled, users continue with the same access they currently have to GUI views and resources. For example, users could be managed through an NFM-P user database or a WS-NOC user database. User access to views and resources are defined based on functional areas within NSP. A user's user group is configured with roles that define what they can access within NSP.

In CLM deployments, UAC applies to CLM users.

When UAC is enabled, access is assigned at the NSP level and applies across the NSP GUI. Users will see their specified NSP access permissions enforced when they login to NSP. The user access configuration specified in NSP is enforced **in place of** any pre-existing access control setup (from NFM-P or WS-NOC). Local NSP user access to NSP resources is always controlled through NSP, regardless of whether UAC is enabled or not.

As a network evolves, an NSP administrator must create or modify user groups, roles, and resource groups to provide the required user access to NSP functions. Be aware of functional cross-dependencies.

When UAC is enabled, it controls user access to NSP functions independently of the user management systems in NFM-P or WS-NOC.

UAC does not apply to WS-NOC or NFM-P GUI or OSS client sessions if pre-existing user access control mechanisms are in use. If you maintain your NSP user accounts in an NFM-P user database, all NFM-P functions related to user lifecycle management, such as password expiry time or failed-login lockout, also affect NSP user access. Local NSP user accounts are configured for UAC and lifecycle management entirely within the NSP.

Figure 8-1 User Access Control architecture

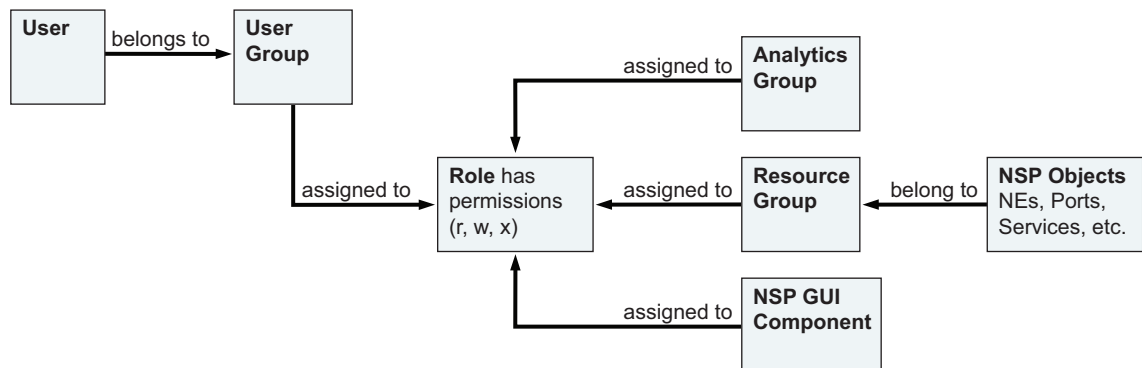

37372

8.10.2 Roles

A role object specifies which resources and NSP functions its associated user groups can access. Network resource access is assigned to a role through resource groups, while functional access and Analytics resource access are specified directly on a role object.

NSP administrator role

A predefined NSP administrator role, user group, and admin user account are automatically created during NSP system installation and cannot be modified. The admin user has full access to all NSP functions and resources, and can define the roles and resource groups that are assigned to user groups. The admin user can create additional roles with the Administrator designation, which carries the same unlimited functional and resource access.

Lawful Intercept role

The Lawful Intercept (LI) role designation is intended for use with an LI user group. The activities of LI users are not tracked under the User Activity Logging function. The admin user must assign GUI and resource access to Lawful Intercept-designated roles.

8.10.3 User groups

A user group associates a group of NSP users with one or more roles, thereby enabling user access to functional areas and resources. Administrators create user groups and assign roles to them, according to the type of network activities the user group is meant to perform. When a role is assigned to a user group, all users within the group have the same access to resources and functions, as specified on the role. A user group can be assigned multiple roles to allow broader access rights for its users.

Individual NSP users can be created by external authentication sources (NFM-P, LDAP, RADIUS, TACACS) where users are assigned to corresponding user groups. In order for the members of a user group to have access to NSP resources and functions, the user group name returned by the authentication source must exactly match a corresponding user group name in NSP.

Local NSP users and user groups can also be created in the NSP.

Users requiring WS-NOC access require a user group assignment that maps to a predefined WS-NOC role; for information, see *To map external user groups to predefined WS-NOC roles* in the *NSP Installation and Upgrade Guide*.

8.10.4 Resource groups

A resource group is a collection of network equipment or services which can be assigned to a role. The role is assigned to a user group, thereby granting the user group access to the network resources in the resource group. Resource groups are defined in Map Layouts and Groups.

8.11 Workflow: Configure User Access Control

8.11.1 Purpose

This workflow describes the recommended order of tasks to configure UAC across NSP. The sequence of tasks outlined here is especially recommended if you are setting up UAC in NSP for the first time. Once you have UAC deployed in NSP, you can configure your user groups, roles, and resource groups in any order.

8.11.2 Steps

Prerequisite: create group directories and resource groups

1

You create group directories and resource groups in Map Layouts and Groups. Resource groups (of NEs, ports, LAGs, or services) are applied to role objects to grant user access rights to network resources. See [8.28 “How do I create a group directory?”](#) (p. 144) and [8.29 “How do I configure a resource group?”](#) (p. 144)

Optional: configure Analytics reporting

2

If you intend to use NSP Analytics reporting, you must fully configure Analytics before you to configure Analytics resource access in your roles. You cannot configure resource access on a role if Analytics is not enabled in the NSP configuration.

Create roles

3

Create roles according to the type of tasks your user groups will be performing, and the types of resources they will need to access. A role object specifies access rights to specific NSP functions and resources; see [8.13 “How do I configure a role?”](#) (p. 128)

Import or create users and user groups

4

Choose one of the following options:

- Create local NSP users; see [8.3 “How do I create an NSP local user?”](#) (p. 115).
- If you have a user access control configuration from NFM-P, it is strongly recommended that you import your users and user groups from NFM-P. This ensures that all of your existing users are included in the new access control setup, and helps ensure a seamless transition from the NFM-P; see [8.4 “How do I import users and groups from NFM-P?”](#) (p. 116).
- If you are configuring user access control for a remote authentication source, create new user groups; see [8.15 “How do I configure a user group?”](#) (p. 132).

Enable UAC

5



Note: When you enable UAC in NSP, individual users will see their specified access rights enforced when they login to NSP. The user access configuration you create are enforced **in place of** any previous access-control setup, except in the NFM-P and WS-NOC, which each employ local user management. Local NSP user access to NSP resources is always controlled through NSP, regardless of whether UAC is enabled or not.

Once you have configured and reviewed your user groups and their associated roles, you can enable UAC; see [8.16 “How do I enable User Access Control?”](#) (p. 133)

Update LDAP TLS certificate

6

If the TLS certificate of the LDAPS remote authentication source is updated, you must also update the LDAPS certificate on the NSP deployer host, as described in [8.18 “How do I update the NSP TLS certificate for LDAPS remote authentication?”](#) (p. 135)

END OF STEPS

8.12 How do I configure alarm access using roles?

8.12.1 Purpose

Users can only view alarms for objects that are included in the resource groups assigned to their roles. Viewing service-related alarms requires access to the appropriate service-related objects.

Consider the following when configuring service-related alarm access:

- **Service Site:** the user must have access to the associated NE and service to view alarms for a service site.
- **SAPs:** the user must have access to the associated service and the (NE | port) to view alarms for a SAP.
- **Physical Links:** the user must have access to all endpoint objects to view alarms for a physical link.
- **LAGs:** the user must have access to the associated NE to view alarms for a LAG.
- **Tunnel Bindings:** the user must have access to the associated NE and service to view alarms for a tunnel binding.
- **Unhealthy NEs view:** the user must have access to any NEs that might appear in the page.

The following workflow describes the high-level steps required to create a role intended for alarm management, and to assign it to a user group. This workflow applies to all NSP users who need to view object alarms, regardless of which NSP UI they use for alarm viewing.

8.12.2 Steps

Create resource groups

1

Create an NE | port | LAG group directory; see [8.28 “How do I create a group directory?”](#) (p. 144)

2

Create an NE | port | LAG resource group in the group directory, and define a filter that includes the network elements the user needs to view; see [8.29 “How do I configure a resource group?”](#) (p. 144)

3

Create a service group directory; see [8.28 “How do I create a group directory?”](#) (p. 144)

4

Create a Service resource group in the service group directory, and define a filter that includes the services the user needs to view. You can create multiple service resource groups within a group directory; see [8.29 “How do I configure a resource group?”](#) (p. 144)

You can create the service resource group based on a Site ID (NE system address) to include all services for the associated NE.

Assign resource groups to roles

5

Add the resource groups to a role; see [8.13 “How do I configure a role?”](#) (p. 128).

6

Assign the role to the appropriate user group; see [8.15 “How do I configure a user group?”](#) (p. 132).

END OF STEPS _____

8.13 How do I configure a role?

8.13.1 Purpose

A role object specifies access rights to specific NSP functions and network resources. Roles are assigned to user groups, bringing all access rights defined on the role to all members of the user group.

Consider the following before configuring a role:

- If you intend to assign resource group access to a role, you must configure your resource groups before completing this procedure.
- If you intend to assign Data Collection and Analysis resource access in this role, you must first configure Data Collection and Analysis, and must assign Read/Write/Execute permission to the Analyze/Assure or Data Collection and Analysis category.
- A user with access to device discovery must also be given access to device management. Device management access is required to view discovered devices.



Note: Do not confuse the Access settings with the Deployment Control settings that are configured in the NSP settings; the Deployment Control settings determine which NSP views are activated and available.

8.13.2 Steps

- 1 _____
Open Users and Security.
- 2 _____
Select **Roles** from the drop-down list on the toolbar.
- 3 _____
Click **+ Create Role**. The Create Role form opens.
- 4 _____
In the Identification panel, specify a role name and description.
The Role Name and Description fields can employ **only** the following special characters: @ - _.
The Role Name string must not contain *any* spaces, including a leading or trailing space.
- 5 _____
In the Characteristics panel, you can enable special designations for the role:
 - To create an administrative role with access to all resource groups and function, enable the **Administrator** check box.
If you enable this option, no further steps are necessary. Click **Create** to save the role.

-
- If the role is intended specifically for Lawful Intercept users, enable the **Lawful Intercept** check box.
LI users are exempt from the User Activity Logging function.

6

To assign NSP functional access to the role, go to the Action Permissions panel and select an access level from the drop-down list for each NSP GUI you want to include in the role. For a description of the access permissions, see [8.17.2 “NSP action permissions” \(p. 134\)](#).

If you intend to assign Data Collection and Analysis resource access in this role, you must assign Read/Write/Execute permission to Data Collection and Analysis.

7

To assign network resource access to the role, go to the Resource Groups Access panel. (For a detailed explanation of the Resource Groups Access panel, see [8.14 “How do I set network resource access levels?” \(p. 131\)](#).)

You can assign resource group access globally, to resource group categories, to individual resource groups, or a combination of these.

- a. You can assign resource group access globally by resource type. Enable either or both options:
 - **Access To All Equipment** assigns full permissions on all NE resource groups and port resource groups to the role.
 - **Access To All Services** assigns full permissions on all service resource groups to the role.
- b. Expand the resource group category for resource groups you want to include in the role. (For a detailed explanation of the Network Resource Access panel, see [8.14 “How do I set network resource access levels?” \(p. 131\)](#).)
 - Select an access level from the drop-down list for each resource type you want to include in the role.
 - If you specify an access level to a resource group category, all resource groups within the category are included in the role at the same access level.If the Group Category list is empty or the resource group you are looking for does not appear, you can create resource groups in the Map Layouts and Groups view.

8

To assign Analytics resource access to the role, go to the Analytics Resource Access panel.

In order for the Analytics Resource Access panel to appear, Analytics reporting must be enabled and configured in NSP and you must assign Read/Write/Execute access to Analytics in this role.

Assign access to Analytics categories or individual Analytics resources in the Analytics Repository list:

- To obfuscate specific Analytics report data for user groups associated with the role, enable the **Data Anonymization** check box.

-
- Assign access to an entire Analytics category from by enabling the associated **Permissions** check box .
 - Assign access to individual Analytics resource items by expanding an Analytics category, selecting an Analytics resource, and enabling its corresponding **Permissions** check box .

Some Analytics categories have nested subcategories, each containing individual Analytics resources. An Analytics category or subcategory with access granted on all contained resources is displayed as fully-enabled . If access is granted on only some contained resources, it is displayed as partially-enabled .

i **Note:** The View/Execute permissions for a report in an Analytics report repository do not apply to drill-downs.
For example, a user group has View/Execute permission for report A but no permission for report B. If report B is a drill-down from report A, users will be able to execute report A via report B, although this might not seem obvious.

9

Click **Create** to save your changes and return to the Roles list.

END OF STEPS

8.14 How do I set network resource access levels?

8.14.1 Overview

This topic describes the features of the Resource Groups Access panel in the Create Role form. You can search for specific resources and you can search for resources with a common access level. Use this topic as a reference when performing the [8.13 “How do I configure a role?”](#) (p. 129) procedure.

8.14.2 Filter the list

You can filter the network resource list to a specific access level by selecting an access level from the drop-down list at the top of the Permissions column. The list is reduced to show only resources that have the same access level. The filter is set to a null value (no access level selected) by default so that all available resources are displayed in the list.

Network Resource Access

Access to all Equipment

Grants read/write/execute permissions

Access to all Services

Grants read/write/execute permissions

Permissions

Group Category

None

Read

Read / Write

Select an access level to filter the list to show only resources with that access level

8.14.3 Search the list

You can search the resource list by typing a string in the Search field at the top of the Group Category column. The list updates dynamically with matching entries as you type.

8.14.4 Set access permissions on a category

You can set global access permissions on an entire category of resources. Select an access level from the drop-down list next to a resource group category. The access permissions are set to the same level for all resources in the category.

8.14.5 Set access permissions on an individual item

You can set access permissions on a single resource group. Expand the resource group and then select an access level from the drop-down list next to a resource group.

8.15 How do I configure a user group?

8.15.1 Purpose

A user group is a definition of user roles and associated access rights. You assign NSP GUI and resource access rights to a user group through role objects. When a role is assigned to a user group, all access rights defined on the role are assigned to the user group.

To configure a complete user group, you must configure the roles before performing this procedure; see [8.13 “How do I configure a role?”](#) (p. 129)

8.15.2 Steps

- 1 _____
Open Users and Security.
- 2 _____
Select **User Groups** from the drop-down list on the toolbar.
- 3 _____
Click **+ Create User Group**. The Create User Group form opens.
To make changes to an existing user group, select the group in the list and click **⋮ Table Row Actions, Edit User Group**. The Edit User Group form opens.
- 4 _____
Specify a group name and description in the **Identification** panel.
The user group name you specify here must exactly match a corresponding user group name returned by your user repository.
The User Group Name and Description fields can employ **only** the following special characters:
@ - _.
The User Group Name string must not contain *any* spaces, including a leading or trailing space.
- 5 _____
To assign user roles to the group, click **+ Add Roles** on the Roles panel. The Add Roles form opens.
- 6 _____
Enable the check box for each role you want to assign to the group and click **Done**. The roles are added to the Selected Roles list.
To remove a role item from the Selected Roles list, click **🗑 Delete** on the item.
- 7 _____
Click **Create** to save your changes and return to the User Groups list.

END OF STEPS

8.16 How do I enable User Access Control?

8.16.1 Purpose

i **Note:** When you enable user access control, individual users will see their NSP access rights enforced when they login to NSP.

The user groups and roles you create are enforced **in place of** any previous access-control setup, except in the NFM-P and WS-NOC, which each employ local user management.

8.16.2 Steps

- 1 _____
Open Users and Security, User Groups.
- 2 _____
Click **More Actions, Settings**.
- 3 _____
In the Access Control Settings form, enable the **NSP User Access Control** option.
- 4 _____
Click **Save** to enable access control.

END OF STEPS _____

8.17 What are NSP operator roles and responsibilities?

8.17.1 NSP operators

Operator responsibilities determine whether you assign Read or Write privileges to the resource groups of an associated role. For example, the administrator role has Write privileges to all resources. A user with an assigned network operator role, however, may have Read access to the NEs in multiple resource groups for troubleshooting purposes, but be granted Write access only to the resource group for the NEs that they maintain.

i **Note:** When only functional access is configured in a role that has no assigned resource groups, the role has full access to all resource groups.

The following table lists and describes typical network operator roles and responsibilities as examples for NSP role creation.

Role	Responsibilities
Administrator	User Access Control, network monitoring, system administration
Network operator	Network fault detection and troubleshooting, equipment health and service infrastructure monitoring

Role	Responsibilities
Service operator	Multi-layer service provisioning
Network engineer, traffic path	Routing management, optimization, and planning
Network engineer, cross-domain	Network connectivity, optimization, and planning
Network engineer, provisioning	Device configuration, NE software and script management

8.17.2 NSP action permissions

Action Permissions are settings that control what users can see and do within different NSP modules. Permissions are configured per module and will include some or all of: None, Read, Read & Write, Read & Execute, Read Write & Execute. The following table lists the NSP action permissions.

Action permission	Description
Analytics Reports	Access to reports created from raw or aggregated data collected using the NFM-P or NSP telemetry.
Data Collection and Analysis Management	Access to telemetry subscriptions, aggregation and age-out policies, baselines, and indicators. Also provides access to OAM tests, templates, test suites, test results, and configuration objects when combined with the OAM Tests permission.
Device Management	Access to managed NEs, ZTP process, configuration deployments, configuration templates, configuration intent types, operations, operation schedules, operation types, and NE images.
File Server	Access to a utility for importing and managing files required by various NSP functions.
Network Intents	Access to intent artifacts, mediators, and policies. This will affect CRUD, lifecycle management, and import capabilities.
NE Inventory	Access to a tree of configured equipment (shelf, card slot, card, port) and logical objects (link aggregation groups, routing instances, ACL sets, BFD) on a selected NE.
Model Driven Configurator	Access to configure parameters and view state information on NEs managed by MDM for which MDC adaptors have been installed.
Device Discovery	Access to NE discovery rules, mediation policies, and reachability policies.
OAM Tests	Access to OAM tests, test templates, test suites, test results, and configuration objects. Access is available in Data Collection and Analysis Management when combined with the Data Collection and Analysis Management role.

Action permission	Description
Workflows	Access to workflow artifacts, actions, environment variables, executions, and triggers. This will affect CRUD, execution management, trigger management, and debugging capabilities.

8.18 How do I update the NSP TLS certificate for LDAPS remote authentication?

8.18.1 Purpose

The TLS certificate for LDAPS remote authentication must be current, or the remote authentication attempts fail.

Perform this procedure if the TLS certificate of the LDAPS remote authentication server is updated.

i **Note:** You must perform the procedure on each NSP cluster.

8.18.2 Steps

1 _____

Obtain the new certificate.

2 _____

Log in as the root user on the NSP deployer host.

3 _____

Open a console window.

4 _____

Transfer the certificate to the following directory on the NSP deployer host:

`/opt/nsp/NSP-CN-DEP-release-ID/NSP-CN-release-ID/tls/ldap`

5 _____

Enter the following to apply the certificate:

```
# /opt/nsp/NSP-CN-DEP-release-ID/bin/nspdeployerctl install --config
--deploy ↵
```

6 _____

Restart the Keycloak pod.

1. Log in as the root user on the NSP cluster host.

2. Enter the following:

```
# kubectl get pods -A | grep nspos-keycloak ↵
```

The following Keycloak pod information is displayed:

How do I update the NSP TLS certificate for LDAPS remote authentication?

```
namespace nspos-keycloak-pod_ID n/n Running 1 (timespan  
ago) timespan
```

3. Record the *pod_ID* value.

4. Enter the following:

```
# kubectl delete pod nspos-keycloak-pod_ID -n $(kubectl get pods -A  
| awk '/nspos-keycloak-pod_ID/ {print $1;exit}')
```

where *pod_ID* is the Keycloak pod ID recorded in substep 3

The Keycloak pod restarts, and the updated certificate is put into effect.

7

Close the console window.

END OF STEPS

User session management and logging

8.19 What is user session management?

8.19.1 User sessions

The session management function lets administrative users monitor active user sessions in NSP. The Sessions GUI lists all active NSP user sessions and RESTCONF API sessions.

Administrative users can manually terminate one or more user sessions and send messages to one or more active NSP users. Messages would typically be sent to forewarn users of an upcoming session termination, or for other operational events in the NSP system. Messages appear in any NSP views the recipient users have open. Messages are flagged as Information, Warning, or Urgent. Recipient users must have NSP open on their desktop to receive messages.

i **Note:** You cannot send messages to RESTCONF API sessions because they do not involve actual users. Exercise caution in terminating RESTCONF API sessions, as they often involve critical network functions.

8.19.2 User activity logging

Administrators can use the NSP user activity logging function to monitor users' actions across NSP functional areas. NSP user actions are logged in the Users and Security, User Activity Logs view, including actions invoked through RESTCONF APIs or NSP UIs.

NSP user event logs contain the following types of information:

- identity of user associated with event
- event type (configuration change, file access, etc.)
- executed operations and their results
- event time

You can retain activity logs for up to 365 days, with up to 10 000 000 log events, as configured in the User Activity Logs settings. You can also export activity logs to an external file for archival purposes.

i **Note:** The NFM-P and WS-NOC activity logging functions run separately from NSP activity logging.

8.20 How do I terminate user sessions?

8.20.1 Steps

- 1 _____
Open **Users and Security**.
- 2 _____
Select **Sessions** from the drop-down list on the toolbar.

3 _____
To terminate a single session, select a user session in the list and click  **Terminate Session** on the right-hand side of the item.

4 _____
To terminate multiple sessions, press the Ctrl key and click on the session items you want to terminate, or select all of the sessions by clicking  **Select All** on the toolbar, and then clicking  **Terminate Session** on the toolbar.
You can cancel a **Select All** command by clicking **Deselect All** on the toolbar.

5 _____
At the prompt, confirm the session termination.

END OF STEPS _____



8.21 How do I send a message to active users?

8.21.1 Steps

1 _____
Open Users and Security.

2 _____
Select **Sessions** from the drop-down list on the toolbar.

3 _____
Do one of the following:

1. To send a message to one user, select a user session in the list and click  **Table Row Actions, Send Message** on the right side of the item.
2. To send a message to all active users, click  **Send Broadcast Message** on the toolbar.

4 _____
In the message form that opens, select a message type and then type your message text in the box.

5 _____
Click **Send**.
A confirmation message appears.



Note: Although a message may be confirmed as Sent, this does not guarantee that the message is received by all users. Under some circumstances (user logged out, browser window closed, etc.) some users may not receive the message.

END OF STEPS

8.22 How do I view user events?

8.22.1 Purpose

This procedure describes basic user event viewing options.

8.22.2 Steps

1

Open Users and Security.

2

Select **User Activity Logs** from the drop-down list on the toolbar.

The User Activity Logs list displays a list of user events over a specified time period (All Available, by default).

3

Use any of the following viewing options to control what you see in the log:

- **Change the log event time period:** Click  and specify a new time period.
- **Filter the Log under a specific column:** Type a text string in the text field at the top of a column and press Enter.
When typing a search string for the User Name column, you must type a complete, case-sensitive, user name. For other columns, you can type a partial search string.
- **Sort the Log under a specific column:** Click on a column header to sort the list under that column, in alphabetical or numerical order. Click the column header a second time to reverse the sort order. Click the column header a third time to clear sorting under that column.

4

To view details about a specific log event, click on the event item in the log.

The Info panel displays expanded information about the event, including the name of the user who executed the event, affected objects, and affected parameters.

END OF STEPS

8.23 How do I set the User Activity Log to auto-refresh?

8.23.1 Purpose

The Auto Refresh function continually updates the Activity Log GUI with the most recent system events. Auto Refresh is disabled by default in User Activity Logs.

8.23.2 Steps

1 _____
Open Users and Security.

2 _____
Select **User Activity Logs** from the drop-down list on the toolbar.

3 _____

Consider the following when enabling Auto Refresh:

- **Auto Refresh On:** if you select an event item in the activity log when Auto Refresh is enabled, the event selection and associated information in the Info panel is cleared at the next auto-refresh. You must select the event again to re-display its information in the Info panel.
If you want an item selection to remain static while you view it, turn off Auto Refresh.
- **Auto Refresh Off:** with Auto Refresh disabled, the User Activity Log is only updated when you click  **Refresh List**.

4 _____
Click **Ok** to close the Saved Filters form.

END OF STEPS _____

8.24 How do I set limits for log event retention?

8.24.1 Purpose

Use the Settings form to set the maximum retention period for log events, the maximum number of log events to be retained, and overflow settings for log events that exceed the maximum.

8.24.2 Steps

1 _____
Open Users and Security.

2 _____
Select **User Activity Logs** from the drop-down list on the toolbar.

The User Activity Logs list displays a list of user events over a specified time period (All Available, by default).

3

Click  **More Actions, Settings**.

4

Set the maximum number of days that log events will be retained in the **Log Retention Period** field (minimum 30 days, maximum 365 days).

5

Set the maximum number of individual log events that can be retained during the retention period in the **Maximum Number of Logs** field (minimum 100000 events, maximum 10000000 events).

6

When either of the **Log Retention Period** or **Maximum Number of Logs** settings is approached or reached, a certain percentage of the stored log events are purged from the database.

Configure overflow settings for log events that approach or exceed the maximum settings:

- **Warning Threshold (%)**: percentage of maximum settings at which a warning message is sent.
- **Warning Purge Amount (%)**: percentage of total log events purged from the database when warning threshold is reached.
- **Critical Threshold (%)**: percentage of maximum settings at which a critical warning message is sent.
- **Critical Purge Amount (%)**: percentage of total log events purged from the database when critical threshold is reached.

7

Save your changes and close the form.

END OF STEPS

8.25 How do I export activity log events?

8.25.1 Purpose

You can export activity logs to an external file for archival purposes. You can export the entire log contents, or only selected events.

8.25.2 Steps

1 _____
Open Users and Security.

2 _____
Select **User Activity Logs** from the drop-down list on the toolbar.
The User Activity Logs list displays a list of user events over a specified time period (All Available, by default).

3 _____
On the User Activity Logs list, do one of the following:

- To export the entire activity log contents, click **More Actions, Export All** on the NSP banner.
- To export only selected log events, use Ctrl+click or Shift+click to select the events you want to export and then click **More Actions, Export Selected** on the NSP banner.

A Save As form appears.

4 _____
Specify a location to save the export file and click **Save**.
The exported log is saved as a .csv file in a .zip archive.

END OF STEPS _____

Network resource groups

8.26 What are group directories and resource groups?

8.26.1 Group directories and groups

Network resource group directories and resource groups are groupings of network equipment. Resource groups are associated with roles to grant NSP user access permissions to specific network resources. A resource group is a collection of network objects of the same type, and a group directory is a collection of resource groups.

 **Note:** Network resource groups have no relationship with resource pools. The two have completely different functions in NSP.

You can configure the following types of resource groups:

- Network element resource groups
- Port resource groups
- LAG resource groups
- Service resource groups

8.27 Workflow: create group directories and resource groups

8.27.1 Purpose

A resource group is a logical set of network equipment or services, specified by user-defined inclusion filters. A resource group can belong to multiple group directories.

8.27.2 Steps

- 1 _____
Create a group directory; see [8.28 “How do I create a group directory?”](#) (p. 144).
- 2 _____
Add new resource groups to the group directory; see [8.29 “How do I configure a resource group?”](#) (p. 144).
- 3 _____
Associate existing resource groups with the group directory; see [8.30 “How do I associate a resource group with a group directory?”](#) (p. 146).

END OF STEPS _____

8.28 How do I create a group directory?

8.28.1 Purpose

This procedure describes how to configure a group directory. After you create a specific type of group directory, you can add resource groups of the same type from within the group directory.

8.28.2 Steps

1

In the upper left-hand corner of the GUI, select from the **Manage the Following:** menu the type of group directory you want to configure:

- Network Element Group Directories
- Port Group Directories
- LAG Group Directories
- Service Group Directories

2

On the Group Directories list on the left-hand side of the GUI, click **+ Add Group Directory**. The Add a New Group Directory form appears.

3

Specify a name for the group directory.

4

Click **Ok**. An empty group directory is added to the Group Directories list.

To add a resource group to the group directory, see [8.29 "How do I configure a resource group?"](#) (p. 144)

END OF STEPS

8.29 How do I configure a resource group?

8.29.1 Purpose

This procedure describes how to configure a resource group. You create a specific type of resource group from within a group directory of the same type.

8.29.2 Steps

1

In the upper left-hand corner of the GUI, select from the **Manage the Following:** menu the type of group directory in which you want to configure a resource group:

- Network Element Group Directories
- Port Group Directories
- LAG Group Directories
- Service Group Directories

2

On the Group Directories list on the left-hand side of the GUI, click on the group directory to which you want to add a resource group.

3

On the right-hand side of the GUI, click **+ Add Resource Group**. The Add Group form appears.

4

Specify a name and description for the resource group and follow the instructions in the form, clicking **Continue** to navigate through the pages.

5

In the Add NEs|Ports|LAGs|Services step, specify network resources for the group, either through inclusion filters or manually:

- **Filter resources based on resource attributes.** Select **Attribute Filter** from the menu, click **Add Filter** and select a resource attribute. The available attributes varies according to the type of resource group you are configuring (NE, port, LAG, or service).

When the new filter appears in the list, click **+ Add Filter** and type an attribute value. You can repeat this step to specify multiple attributes.

- **Filter resources based on advanced filter expressions.** Select **Advanced Filter** from the menu. Type a filter expression in the **Filter Contents** field, starting with a resource attribute, followed by a Boolean operator and an attribute value. The system suggests possible attributes, operators, and attribute values as you type, and displays error messages in red when an expression is invalid. You can combine attribute-value expressions using AND and OR operators.

If you are creating a filter to include a large number of resources, it is better to specify an attribute with a range of values to include the resources. Specifying a large number of individual resource attribute values linked together with OR operators creates a complex inclusion filter that will burden system resources and possibly cause the import process to fail.

Any IPv6 addresses in an advanced filter expression *must* be enclosed in single quotation marks (' ').

When you have finished configuring your filters, click **Continue**. The filter results are listed in the Review and Adjustments form.

6

Click **Finish** to save the group.

END OF STEPS

8.30 How do I associate a resource group with a group directory?

8.30.1 Steps

1

On the Group Directories list on the left-hand side of the GUI, click on the group directory with which you want to associate a resource group.

2

Click  **Associate**.

3

In the **Associate Group(s)** form, click **+ Add** and type the name of a resource group in the **Name** field. The list populates with near matches as you type.

4

Select the resource group name you want to associate in the list and click **Done**. You can repeat these steps to select more resource groups for association with the group directory.

5

In the Associate Group(s) form, click **Associate**. The resource group is added to the group directory.

END OF STEPS

8.31 How do I search for a management object?

8.31.1 Purpose

Use this procedure to search for an NE, service, group directory, resource group, or network resource object. The availability of search objects depends on which context you are running: Network Element | Port | Service Group Directories.

8.31.2 Steps

1 _____
Click  **Search**.

2 _____

Select any of the available object types from the menu. For example:

- Group name
- Group directory name
- Service - name, ID, type
- NE - name, management IP, system ID
- Port - port name, NE name, description, system address

3 _____

Type a search string in the text field. The list populates with near matches as you type.

4 _____

Click **Done**.

END OF STEPS _____

9 Classic management security

Securing NFM-P system access

9.1 What is NFM-P security?

9.1.1 Password security

For increased security, it is recommended that you regularly change the passwords of the administrative user accounts on NFM-P components, as described in the following procedures:

- [11.4 “How do I change the nsp user password?”](#) (p. 290)
- [9.2 “How do I change an NFM-P main database password in a standalone system?”](#) (p. 149)
- [9.3 “How do I change an NFM-P main database password in a redundant system?”](#) (p. 152)

9.1.2 NFM-P user management scope

NSP Users and Security, rather than the NFM-P, manages NFM-P GUI client access. To gain GUI client access, an NFM-P operator must sign in to the NSP UI.

 **Note:** NFM-P user management is limited to NFM-P XML API client access; for such users, the NFM-P user group properties define the level of XML API access using the mechanisms described below.

9.2 How do I change an NFM-P main database password in a standalone system?

9.2.1 Purpose

Perform this procedure to change the password of a user associated with the main database in a standalone NFM-P system.



CAUTION

Service Disruption

The procedure requires a restart of the NFM-P main server, which is service-affecting.

It is strongly recommended that you perform this procedure only during a scheduled maintenance period.

 **Note:** Before you perform the procedure, you must ensure that each main server, auxiliary server, and main database is running and operational.

You can use the procedure to change only one user password at a time. To change multiple user passwords, you must perform the procedure multiple times.

When you change a password on one station, the NFM-P automatically updates the password on all other NFM-P stations.

How do I change an NFM-P main database password in a standalone system?

9.2.2 Steps

1 _____

Log in to the main server station as the nsp user.

2 _____

Open a console window.

3 _____

Navigate to the `/opt/nsp/nfmp/server/nms/bin` directory.

4 _____

Enter the following:

```
bash$ ./nmserver.bash passwd ↵
```

The script prompts you for the current Oracle SYS user password.

5 _____

Enter the password. The script validates the password, and then displays a list of user names like the following:

```
SAM Database Users:
- sys
- database_user (installation default is samuser)
Other Database Users:
- sqltxplain
- appqossys
- outln
- dip
- system
- exit
```

6 _____

Enter a user name. The script prompts you for a password.

7 _____

Enter the new password, which must:

- Be between 4 and 30 characters long
- Contain at least three of the following:
 - lower-case alphabetic character
 - upper-case alphabetic character
 - numeric character

- special character, which is one of the following:

\$ _

- Not contain four or more of the same character type in sequence
- Not be the same as the user name or the reverse user name
- Not contain a space character
- Differ by at least four characters from the current password

If the password is valid, the script prompts you to retype the password.

8

Enter the new password again. The following prompt is displayed:

WARNING: Changing passwords may cause instability to the NFM-P server as well as the Oracle proxy on the database server.

Do you want to proceed (yes/no)?:

9

Enter yes ↵. The script displays status messages and then exits. If the status indicates a password change failure, contact technical support.

10

Record the password in a secure location.

11

Perform the following steps.

1. Log in to the main database station as the root user.
2. Open a console window.
3. Enter the following to stop the Oracle proxy:

```
# systemctl stop nfmp-oracle-proxy.service ↵
```

4. Enter the following to stop the main database:

```
# systemctl stop nfmp-main-db.service ↵
```

12

Start the main database.

1. Return to the open console window on the main database station.
2. Enter the following:

```
# systemctl start nfmp-main-db.service ↵
```

3. Enter the following:

```
# systemctl start nfmp-oracle-proxy.service ↵
```

13

Restart the main server.

1. Navigate to the `/opt/nsp/nfmp/server/nms/bin` directory on the main server station.
2. Enter the following to restart the main server:

```
bash$ ./nmserver.bash force_restart ↵
```
3. Enter the following to display the server status:

```
bash$ ./nmserver.bash appserver_status ↵
```

The server status is displayed; the server is fully initialized if the status is the following:
Application Server process is running. See `nms_status` for more detail.

If the server is not fully initialized, wait five minutes and then repeat this step. Do not perform the next step until the server is fully initialized.

14

Close the open console windows.

END OF STEPS

9.3 How do I change an NFM-P main database password in a redundant system?

9.3.1 Purpose

Perform this procedure to change the password of a user associated with the main database in a redundant NFM-P system.



CAUTION

Service Disruption

The procedure requires a restart of each main server, which is service-affecting.

Perform the procedure only during a scheduled maintenance period.



Note: Before you perform the procedure, you must ensure that each main server, auxiliary server, and database is running and operational.

You can use the procedure to change only one user password at a time. To change multiple user passwords, you must perform the procedure multiple times.

When you change a password on one station, the NFM-P automatically updates the password on all other NFM-P stations.



Note: The samuser password expires after 180 days.

9.3.2 Steps

1

Log in to the primary main server station as the nsp user.

2 _____
Open a console window.

3 _____



CAUTION

Service Disruption

Contact technical support before you attempt to modify the `nms-server.xml` file.

Modifying the `nms-server.xml` file can have serious consequences that can include service disruption.

If you are changing the Oracle SYS user or Oracle database user password, disable the automatic database failover function.

1. Navigate to the `/opt/nsp/nfmp/server/nms/config` directory.
2. Open the `nms-server.xml` file using a plain-text editor such as `vi`.
3. Locate the following parameter entry:

```
dbAutoFailOver=value
```

4. Record the parameter value.
5. Edit the entry to read:

```
dbAutoFailOver="no"
```

6. Save and close the `nms-server.xml` file.
7. Navigate to the `/opt/nsp/nfmp/server/nms/bin` directory.
8. Enter the following:

```
bash$ ./nmserver.bash read_config ↵
```

The configuration change is applied, and automatic database failovers are disabled.



Note: Leave the console window open; it is required later in the procedure.

4 _____
Navigate to the `/opt/nsp/nfmp/server/nms/bin` directory.

5 _____
Enter the following:

```
bash$ ./nmserver.bash passwd ↵
```

The script prompts you for the current Oracle SYS user password.

6 _____
Enter the password. The script validates the password, and then displays a list of user names like the following

```
SAM Database Users:
```

```
- sys
- database_user (installation default is samuser)
Other Database Users:
- sqltxplain
- appqossys
- outln
- dip
- system
- exit
```

7

Enter a user name. The script prompts you for a password.

8

Enter the new password, which must:

- Be between 4 and 30 characters long
- Contain at least three of the following:
 - lower-case alphabetic character
 - upper-case alphabetic character
 - numeric character
 - special character, which is one of the following:
\$ _
- Not contain four or more of the same character type in sequence
- Not be the same as the user name or the reverse user name
- Not contain a space character
- Differ by at least four characters from the current password

If the password is valid, the script prompts you to retype the password.

9

Enter the new password again. The following prompt is displayed:

```
WARNING: Changing passwords may cause instability to the NFM-P server
as well as the Oracle proxy on the database server.
```

```
Do you want to proceed (yes/no)?:
```

10

Enter yes ↵. The script displays status messages and then exits. If the status indicates a password change failure, contact technical support.

11

Record the password in a secure location.

12

If you are changing a password other than the SYS or Oracle database user password, go to [Step 18](#).

13

Stop each main database; stop the standby first, and then the primary.

1. Log in to the database station as the root user.
2. Open a console window.
3. Enter the following:

```
# systemctl stop nfmp-oracle-proxy.service ↵
```
4. Enter the following:

```
# systemctl stop nfmp-main-db.service ↵
```

i **Note:** For convenience, leave the console window open; it is required later in the procedure.

14

Stop the standby main server.

1. Log in to the standby main server station as the nsp user.
2. Open a console window.
3. Navigate to the /opt/nsp/nfmp/server/nms/bin directory.
4. Enter the following:

```
bash$ ./nmserver.bash stop ↵
```

5. Enter the following:

```
bash$ ./nmserver.bash appserver_status ↵
```

The server status is displayed; the server is fully stopped if the status is the following:

```
Application Server is stopped
```

If the server is not fully stopped, wait five minutes and then repeat this step. Do not perform the next step until the server is fully stopped.

i **Note:** For convenience, leave the console window open; it is required later in the procedure.

15

Start each main database; start the primary first, and then the standby.

1. Return to the open console window on the database station.
2. Enter the following:

```
# systemctl start nfmp-main-db.service ↵
```
3. Enter the following:

```
# systemctl start nfmp-oracle-proxy.service ↵
```

-
4. Close the console window.

16

Restart the primary main server.

1. Return to the open console window on the primary main server station.
2. Enter the following:

```
bash$ ./nmserver.bash force_restart ↵
```

The primary main server restarts.

3. Enter the following:

```
bash$ ./nmserver.bash appserver_status ↵
```

The server status is displayed; the server is fully initialized if the status is the following:

```
Application Server process is running. See nms_status for more detail.
```

If the server is not fully initialized, wait five minutes and then repeat this step. Do not perform the next step until the server is fully initialized.



Note: For convenience, leave the console window open; it may be required later in the procedure.

17

Start the standby main server.

1. Return to the open console window on the standby main server station.
2. Enter the following:

```
bash$ ./nmserver.bash start ↵
```

3. Enter the following:

```
bash$ ./nmserver.bash appserver_status ↵
```

The server status is displayed; the server is fully initialized if the status is the following:

```
Application Server process is running. See nms_status for more detail.
```

If the server is not fully initialized, wait five minutes and then repeat this step. Do not perform the next step until the server is fully initialized.

4. Close the console window.
5. Log out of the standby main server station.

18



CAUTION

Service Disruption

Modifying the nms-server.xml file can have serious consequences that can include service disruption.

Contact technical support before you attempt to modify the file.

If the dbAutoFailOver value recorded in [Step 3](#) is yes, re-enable the automatic database failover function.

1. Navigate to the /opt/nsp/nfmp/server/nms/config directory on the primary main server station.
2. Open the nms-server.xml file using a plain-text editor such as vi.
3. Locate the following parameter entry:

```
dbAutoFailOver="no"
```

4. Edit the entry to read:

```
dbAutoFailOver="yes"
```

5. Save and close the nms-server.xml file.
6. Navigate to the /opt/nsp/nfmp/server/nms/bin directory.
7. Enter the following:

```
bash$ ./nmserver.bash read_config ↵
```

The configuration change is applied, and automatic database failovers are enabled.

19

Close the open console windows.

20

Log out of the primary main server station.

END OF STEPS

9.4 How do I update the supported NFM-P TLS versions and ciphers?

9.4.1 Purpose



CAUTION

Service Disruption

Updating the TLS version and cipher support requires a complete NFM-P system shutdown, which creates a network management outage.

Perform the procedure only during a scheduled maintenance period of sufficient duration with the guidance of technical support.

Outdated TLS versions or ciphers present a security risk. Perform this procedure to update the lists of supported TLS versions and ciphers in an NFM-P system.

- i** **Note:** An NFM-P system upgrade replaces the current TLS version and cipher support settings with the defaults for the new release. After an upgrade, you may need to reconfigure the settings.
- i** **Note:** You require the following user privileges:
 - on each main and auxiliary server station — root, nsp
 - on each NSP Flow Collector station — root
 - on each main database station — root, Oracle management user
- i** **Note:** The Oracle management user and group names are specified during database installation; the default is 'oracle' in the 'dba' group.
- i** **Note:** The following RHEL CLI prompts in command lines denote the active user, and are not to be included in typed commands:
 - # —root user
 - bash\$ —nsp, Oracle management users

9.4.2 Steps

Prepare new cipher and TLS files

1 _____
Log in to the standalone or primary NFM-P main server station as the nsp user.

2 _____
Enter the following:

```
bash$ cd /opt/nsp/nfmp/server/nms/bin/security_management/ssl ↵
```

3

Enter the following to create the default cipher list file:

```
bash$ ./ciphers_and_tls_update.bash create -cdc default-ciphers-file ↵
```

4

Enter the following to create the default TLS list file:

```
bash$ ./ciphers_and_tls_update.bash create -cdt default-TLS-file ↵
```

5

Enter the following to copy the default ciphers file to a new file:

```
bash$ cp default-ciphers-file new_ciphers_file ↵
```

where *new_ciphers_file* is the name to assign to the new ciphers file

6

Open *new_ciphers_file* using a plain-text editor such as vi.

7

Edit the file to remove any unsupported ciphers.

8

Save and close the file.

9

Enter the following to copy the default TLS file to a new file:

```
bash$ cp default-TLS-file new_TLS_file ↵
```

where *new_TLS_file* is the name to assign to the new TLS file

10

Open *new_TLS_file* using a plain-text editor such as vi.

11

Edit the file to remove any unsupported TLS versions.



Note: You must not remove TLSv1.2.



Note: TLSv1.0 and TLSv1.1 are deprecated in IETF RFC [draft-ietf-tls-oldversions-deprecate-06](#).

12

Save and close the file.

Distribute files to system components

13

If the NFM-P system is redundant, distribute the required files to the standby main server station.

1. Log in to the standby main server station as the root user.
2. Enter the following:

```
# cd /opt/nsp/nfmp/server/nms/bin/security_management/ssl ↵
```
3. Copy the following files from the primary main server station to the current directory:
 - /opt/nsp/nfmp/server/nms/bin/security_management/ssl/new_ciphers_file
 - /opt/nsp/nfmp/server/nms/bin/security_management/ssl/new_TLS_file

14

If the system includes one or more auxiliary servers, distribute the required files to each auxiliary server station.

1. Log in to the auxiliary server station as the root user.
2. Enter the following:

```
# cd /opt/nsp/nfmp/auxserver/nms/bin/security_management/ssl ↵
```
3. Copy the following files from the standalone or primary main server station to the current directory:
 - /opt/nsp/nfmp/server/nms/bin/security_management/ssl/new_ciphers_file
 - /opt/nsp/nfmp/server/nms/bin/security_management/ssl/new_TLS_file
4. Enter the following:

```
# chown nsp:nsp new_ciphers_file ↵
```
5. Enter the following:

```
# chown nsp:nsp new_TLS_file ↵
```

15

If the system includes one or more NSP Flow Collectors, distribute the required files to each NSP Flow Collector station.

1. Log in to the station as the nsp user.
2. Enter the following:

```
bash$ mkdir /opt/nsp/cipher_update ↵
```
3. Enter the following to switch to the root user

```
# su ↵
```
4. Transfer the following files from the standalone or primary main server station to the /opt/nsp/cipher_update directory:
 - /opt/nsp/nfmp/server/nms/bin/security_management/ssl/ciphers_and_tls_update.bash
 - /opt/nsp/nfmp/server/nms/bin/security_management/ssl/new_ciphers_file
 - /opt/nsp/nfmp/server/nms/bin/security_management/ssl/new_TLS_file

5. Enter the following:

```
# chmod a+x /opt/nsp/cipher_update/ciphers_and_tls_update.bash ↵
```

16

Distribute the required files to each main database station.

1. Log in to the main database station as the Oracle management user.
2. Enter the following:

```
bash$ mkdir ~user/cipher_update ↵
```

where *user* is the name of the Oracle management user

3. Enter the following to switch to the root user:

```
# su ↵
```

4. Copy the following files from the standalone or primary main server station to the *~user/cipher_update* directory, where *user* is the name of the Oracle management user:

- /opt/nsp/nfmp/server/nms/bin/security_management/ssl/ciphers_and_tls_update.bash
- /opt/nsp/nfmp/server/nms/bin/security_management/ssl/new_ciphers_file
- /opt/nsp/nfmp/server/nms/bin/security_management/ssl/new_TLS_file

5. Enter the following:

```
# chown -R user:group ~user/cipher_update/ ↵
```

where

user is the Oracle management user name

group is the Oracle management user group

6. Enter the following:

```
# chmod a+x ~user/cipher_update/ciphers_and_tls_update.bash ↵
```

where *user* is the Oracle management user name

Stop NFM-P system

17

Close the open client sessions.

1. Open an NFM-P GUI client using an account with security management privileges, such as admin.
2. Choose Administration→Security→NFM-P User Security from the main menu. The NFM-P User Security - Security Management (Edit) form opens.
3. Click on the Sessions tab.
4. Click Search. The form lists the open GUI and XML API client sessions.
5. Identify the GUI session that you are using based on the value in the Client IP column.
6. Select all sessions except for the session that you are using.
7. Click Close Session.
8. Click Yes.

9. Click Search to refresh the list and verify that only the current session is open.
10. Close the NFM-P User Security - Security Management (Edit) form.
11. Close the GUI.

18

If the NFM-P system is redundant, stop the standby main server.

1. Log in to the standby main server station as the nsp user.
2. Open a console window.
3. Enter the following:

```
bash$ /opt/nsp/nfmp/server/nms/bin/nmsserver.bash stop ↵
```

The main server stops.

19

If the system includes one or more auxiliary servers, stop each auxiliary server.

1. Log in to the auxiliary server station as the nsp user.
2. Open a console window.
3. Enter the following:

```
bash$ /opt/nsp/nfmp/auxserver/nms/bin/auxnmsserver.bash auxstop ↵
```

The auxiliary server stops.

20

If the system includes one or more NSP Flow Collector Controllers and Flow Collectors, stop each NSP Flow Collector Controller.

i **Note:** If the NSP Flow Collector Controller is collocated on a station with an NSP Flow Collector, stopping the NSP Flow Collector Controller also stops the Flow Collector.

1. Log in to the NSP Flow Collector Controller station as the nsp user.
2. Open a console window.
3. Enter the following:

```
bash$ /opt/nsp/flow/fcc/bin/flowCollectorController.bash stop ↵
```

The NSP Flow Collector Controller stops.

21

If the system includes one or more NSP Flow Collectors that are not collocated on a station with a Flow Collector Controller, stop each such Flow Collector.

1. Log in to the NSP Flow Collector station as the nsp user.
2. Open a console window.
3. Enter the following:

```
bash$ /opt/nsp/flow/fc/bin/flowCollector.bash stop ↵
```

The NSP Flow Collector stops.

22

Stop the standalone or primary main server.

1. Log in to the main server station as the nsp user.
2. Open a console window.
3. Enter the following:

```
bash$ /opt/nsp/nfmp/server/nms/bin/nmsserver.bash stop ↵
```

The main server stops.

23

If the NFM-P system is redundant, stop the standby database proxy.

1. Log in to the standby database station as the root user.
2. Open a console window.
3. Enter the following:

```
# systemctl stop nfmp-oracle-proxy.service ↵
```

The database proxy stops.

24

Stop the standalone or primary database proxy.

1. Log in to the database station as the root user.
2. Open a console window.
3. Enter the following:

```
# systemctl stop nfmp-oracle-proxy.service ↵
```

The database proxy stops.

Apply new cipher and TLS lists

25

Perform the following steps on each main database station to apply the new TLS configuration.

1. Log in as the Oracle management user.
2. Enter the following:

```
bash$ cd ~/cipher_update ↵
```

3. Enter the following:

Note: The `-fo` parameter is optional, and sets the cipher priority according to the order in the specified file. If the parameter is not included, the cipher priority is set to the default order.

```
bash$ ./ciphers_and_tls_update.bash apply -c new_ciphers_file -t  
new_TLS_file -fo ↵
```

where

`new_ciphers_file` is the updated ciphers file

new_TLS_file is the updated TLS file

The script applies the new configuration, and backs up the previous configuration in the following file:

ciphers_and_tls_backup.timestamp.tar.gz

26

Perform the following steps on each main server station to apply the new TLS configuration.

1. Log in as the nsp user.
2. Enter the following:

```
bash$ cd /opt/nsp/nfmp/server/nms/bin/security_management/ssl ↵
```

3. Enter the following:

Note: The `-fo` parameter is optional, and sets the cipher priority according to the order in the specified file. If the parameter is not included, the cipher priority is set to the default order.

```
bash$ ./ciphers_and_tls_update.bash apply -c new_ciphers_file -t  
new_TLS_file -fo ↵
```

where

new_ciphers_file is the updated ciphers file

new_TLS_file is the updated TLS file

The script applies the new configuration, and backs up the previous configuration in the following file:

ciphers_and_tls_backup.timestamp.tar.gz

27

If the system includes one or more auxiliary servers, perform the following steps on each auxiliary server station to apply the new TLS configuration.

1. Log in as the nsp user.
2. Enter the following:

```
bash$ cd /opt/nsp/nfmp/auxserver/nms/bin/security_management/ssl ↵
```

3. Enter the following:

Note: The `-fo` parameter is optional, and sets the cipher priority according to the order in the specified file. If the parameter is not included, the cipher priority is set to the default order.

```
bash$ ./ciphers_and_tls_update.bash apply -c new_ciphers_file -t  
new_TLS_file -fo ↵
```

where

new_ciphers_file is the updated ciphers file

new_TLS_file is the updated TLS file

The script applies the new configuration, and backs up the previous configuration in the following file:

`ciphers_and_tls_backup.timestamp.tar.gz`

28

If the system includes one or more NSP Flow Collectors, perform the following steps on each NSP Flow Collector Controller and Flow Collector station to apply the new TLS configuration.

1. Log in as the nsp user.
2. Enter the following:

```
bash$ cd /opt/nsp/cipher_update ↵
```

3. Enter the following:

Note: The `-fo` parameter is optional, and sets the cipher priority according to the order in the specified file. If the parameter is not included, the cipher priority is set to the default order.

```
bash$ ./ciphers_and_tls_update.bash apply -c new_ciphers_file -t new_TLS_file -fo ↵
```

where

`new_ciphers_file` is the updated ciphers file

`new_TLS_file` is the updated TLS file

The script applies the new configuration, and backs up the previous configuration in the following file:

`ciphers_and_tls_backup.timestamp.tar.gz`

Start NFM-P system

29

Start the standalone or primary database proxy.

As the root user on the database station, enter the following:

```
# systemctl start nfmp-oracle-proxy.service ↵
```

The database proxy starts.

30

If the NFM-P system is redundant, start the standby database proxy.

As the root user on the standby database station, enter the following:

```
# systemctl start nfmp-oracle-proxy.service ↵
```

The database proxy starts.

31

Start the standalone or primary main server.

As the nsp user on the main server station, enter the following:

```
bash$ /opt/nsp/nfmp/server/nms/bin/nmserver.bash start ↵
```

The main server starts.

32

If the NFM-P system is redundant, start the standby main server.

As the nsp user on the standby main server station, enter the following:

```
bash$ /opt/nsp/nfmp/server/nms/bin/nmsserver.bash start ↵
```

The main server starts.

33

If the system includes one or more auxiliary servers, start each auxiliary server.

As the nsp user on the auxiliary server station, enter the following:

```
bash$ /opt/nsp/nfmp/auxserver/nms/bin/auxnmsserver.bash auxstart ↵
```

The auxiliary server starts.

34

If the system includes one or more NSP Flow Collectors, start each NSP Flow Collector Controller and Flow Collector.

i **Note:** If the NSP Flow Collector Controller is collocated on a station with a Flow Collector, starting the NSP Flow Collector Controller also starts the Flow Collector.

1. Log in to the NSP Flow Collector Controller station as the nsp user.
2. Open a console window.
3. Enter the following:

```
bash$ /opt/nsp/flow/fcc/bin/flowCollectorController.bash start ↵
```

The NSP Flow Collector Controller starts.

35

If the system includes one or more NSP Flow Collectors that are not collocated on a station with a Flow Collector Controller, start each such Flow Collector.

1. Log in to the NSP Flow Collector station as the nsp user.
2. Open a console window.
3. Enter the following:

```
bash$ /opt/nsp/flow/fc/bin/flowCollector.bash start ↵
```

The NSP Flow Collector starts.

36

Close the open console windows.

END OF STEPS

NFM-P user security

9.5 What is NFM-P user security?

9.5.1 User security mechanisms

This section describes the NFM-P user security mechanisms for providing and restricting access to various objects and functions. NFM-P user security includes the following:

- user group and account management, which involves the following elements:
 - “[Scope of command roles](#)” (p. 169) — contains the roles that define the level of user control in NFM-P functional areas such as the read, create, update, and delete access permissions
 - “[Scope of command profiles](#)” (p. 169) — contains the appropriate scope of command role for the types of tasks to be performed
 - [9.6.5 “Span of control”](#) (p. 169) — list of objects to which a user has access
 - “[Span of control profiles](#)” (p. 171) — contains the required spans that allow group access to specific NFM-P objects
 - “[Span rules](#)” (p. 172) — directs the NFM-P to add new services to other spans in addition to the Default Service span
- global security parameters such as password expiry periods, the allowed number of login attempts, and any automated security e-mail notifications.
- managing user-group workspaces, which are customized configurations of NFM-P GUI elements; see “NFM-P custom workspaces” in the *NSP NFM-P User Guide* for comprehensive workspace information
- monitoring and managing active client sessions
- remote user access via LDAP/S, RADIUS, and TACACS+ authentication
- deleting NFM-P security elements that are no longer required, such as inactive user accounts or user groups.
- configuring task monitoring parameters and monitoring the progress of operational tasks:
 - GUI client write operations initiated by clicking Apply or OK
 - all write operations performed via the XML API
 - some read operations; for example, when you click Resync or Collect All

 **Note:** See [Appendix A, “Classic management scope of command roles and permissions”](#) for a list of the permissions, access levels, and descriptions of all predefined scope of command roles and profiles.

9.6 How do I manage NFM-P user accounts and groups?

9.6.1 Introduction

You can create NFM-P user accounts and user groups to:

- provide access to the NFM-P functional areas that match operator requirements
- restrict access to functions or objects based on operator expertise or authority

Users have view access, read-write access, or no access to NFM-P objects and functions based on:

- the user group to which the user belongs
- the scope of command profile assigned to the user group

Functional defaults

The default NFM-P user account called admin is assigned the Administrator scope of command role and a span of control profile that has Edit Access assigned to each default span.

i **Note:** Access Control is disabled by default. When Access Control is disabled, other NSP tools such as Sessions and User Activity Logs remain enabled and functional.

i **Note:** To restrict user access to top-level functions such as NFM-P and NE security management, the following guidelines are recommended:

- Assign the administrator scope of command role to a minimal number of NFM-P user accounts.
- Assign each NFM-P user to a user group that has the minimum privileges for performing the required tasks.

9.6.2 General NFM-P security management rules

The following general rules apply to NFM-P user and group security management:

- Only database space limits the number of accounts and groups that can be created.
- A user cannot belong to more than one user group.
- Only one session per user account can be open at the same time on a client station.
- A scope of command profile allows user-group access to one or more NFM-P functional areas.
- A span of control profile allows user-group access to one or more NFM-P managed objects.
- A user group is associated with only one scope of command profile that can contain multiple scope of command roles.
- A user group is associated with only one span of control profile that can contain multiple spans.
- By default, a user group is assigned access to all NFM-P objects.
- A user acquires span of control access rights from the associated user group.
- When you modify a user group, and a user in the group has an open client session, client actions may fail for the user. To put the new user group permissions into effect, the user must close the current client session and open a new session.
- You can modify but not delete a span of control profile that is assigned to a group.

9.6.3 Password management

An NFM-P user password must observe the following constraints:

- It must be 8 to 100 characters.
- It must contain at least three of the following character types:
 - lowercase

-
- uppercase
 - special ()?~!@#\$\$*_+_
 - numeric
 - It cannot be the user name in forward or reverse order.
 - It cannot include more than three consecutive instances of the same character.
 - It must change according to a configurable schedule to prevent account lockout.
 - It cannot be reused as a new password for the same user account.

9.6.4 Scope of command

A scope of command, which defines the actions that a user is allowed to perform, is a collection of configurable roles, which are sets of permissions. A scope of command profile contains one or more roles, and the profile is subsequently applied to a user group. Each user in the group acquires the access rights specified in the scope of command profile.

Scope of command roles

A scope of command role specifies the read, create, update, and delete access permissions for an NFM-P object type or functional area. You can create custom roles by assigning specific access permissions to different functional areas. The functional areas are organized in packages, methods, and classes. See [Appendix A, “Classic management scope of command roles and permissions”](#) for a list of all access permissions that can be assigned to a scope of command role.

 **Note:** When you enable the Create permission, the Update permission is automatically enabled.

 **Note:** When you enable the Update permission, the Create permission is not automatically enabled.

You can create an original scope of command role, or copy an existing role and modify the role permissions to create a role. The NFM-P has several predefined scope of command roles. See [Appendix A, “Classic management scope of command roles and permissions”](#) for a list of the permissions, access levels, and descriptions of all predefined scope of command roles and profiles.

 **Note:** When you create a scope of command role, you must enable create, update/execute, and delete access to allow the modification of a class or package.

Scope of command profiles

A scope of command profile contains one or more scope of command roles, and is assigned to a user group. Each user in the group acquires the permissions from the scope of command roles in the profile.

9.6.5 Span of control

The span of control for a user is a list of the objects over which the user has control, for example, a group of NEs or services. You can create an original span, or copy an existing span and modify the list of associated objects to create a new span. The objects that are in a span, or that can be added to a span, are called span objects.

The NFM-P has several predefined spans. Each new object, for example, a discovered NE, is added to the corresponding predefined span. [Table 9-1, “predefined spans of control” \(p. 169\)](#) lists the predefined spans and the type of span objects in each.

 **Note:** You cannot modify or delete a predefined span.

Table 9-1 predefined spans of control

Span	Included objects
Default Topology Group Span	Topology groups
Default Router Span	Managed NEs
Default Script Span	CLI and XML API scripts, service templates, tunnel templates, and auto-provision profiles
Default Test Suite Span	Test suites
Default Group Span	Ring groups and VLAN groups
Default Bulk Operation Span	Bulk operations
Default Service Span	Services
Default Customer Span	Customers

Spans are specified in span of control profiles that are associated with user groups. A user can create an NFM-P object only when the predefined span for the object type is in the span of control profile. For example, if you do not have the Default Group Span in your span of control profile, you cannot create a ring group.

NEs are added automatically to a span when the parent topology group, ring group, or VLAN group is in a span. An object that is automatically added to a span cannot be removed from the span, but an explicitly added object can be removed.

 **Note:** A user can view or configure a point-to-point connection only when each endpoint of the connection is in the user span of control. For example, when the endpoints of an LSP path are in different spans, you need view or configuration privileges in each span in order to view or configure the LSP path.

When you create a span, you can drag and drop NEs and topology groups into the span contents list.

Each user can control which objects the NFM-P displays in maps, lists, and navigation trees, based on the user span of control. The User Preferences form contains a parameter that globally specifies whether the Edit Access span objects of the user appear by default. Objects that are not in a View Access span of the user are not displayed, regardless of the user preference. See “To filter using span of control” in the *NSP NFM-P User Guide* for information about configuring the user span of control display preference.

In a list form, you can override the global display preference using the Span On parameter. The associated advanced filter form contains a selector for filtering the search results based on the span of control.

Span of control profiles



CAUTION

Service Disruption

It is recommended that you consider the effects of combining customer, service, and NE spans in a span of control profile.

For example, a user can modify a service only when the service, customer, and participating NEs are in one or more Edit Access spans of the user, and none of the objects is in a Blocked Edit or Blocked View span.

A span of control profile is a collection of one or more spans that is assigned to a user group. When you create a profile, each span in the profile is assigned one of the following access types:

- View Access—The user can view the span objects, unless the scope of command permissions deny read access.
- Edit Access—The user can modify the span objects, unless the scope of command permissions deny access.
- Blocked Edit—The user can view but not modify the span objects, regardless of the scope of command permissions.
- Blocked View—The user cannot view or modify the span objects, regardless of the scope of command permissions.

Blocked Edit and Blocked View spans restrict access to a subset of the objects in another span in the same profile. For example, when multiple span of control profiles each contain the Default Service Span, you can add a customer-specific Blocked View or Blocked Edit span to each profile so that the user group associated with a profile can view or configure only the services of specific customers.

A Blocked Edit or Blocked View span takes precedence over other spans. For example, when a user has an Edit Access span that contains all services and a Blocked View span that contains Customer A and Customer B, the user cannot view or configure the services that belong to Customer A and Customer B.

To ensure that span conflicts do not interfere with network troubleshooting, the NFM-P allows a user to execute tests on NEs and service sites that are not in an Edit Access span of the user. However, activities such as policy distribution, software upgrades, and statistics collection can be performed only by a user with Edit Access spans that contain the target objects.

CPAM span of control

CPAM topology maps support span of control for equipment group objects. There are no default CPAM spans. To allow movement of objects on CPAM maps, you must create a custom span of control for CPAM equipment groups and add it to the span of control profile for the required user group. See “CPAM span of control” in the *NSP NFM-P Control Plane Assurance Manager User Guide*. CPAM topology maps are accessed under Tools → Route Analysis in the NFM-P main menu.

Span rules

By default, the NFM-P automatically adds a new service to the Default Service span. Using an XML API client, you can create policies called span rules that add new services to other spans in addition to the Default Service span.

A span rule is associated with a format or range policy, and applies to the users and user groups that are specified in the format or range policy. You can associate multiple range policies with one user and service type, which enables the automatic addition of a new service to a specific span based on the service ID specified when the service is created.

When you create a span rule, you must specify one of the following to indicate which spans receive the services that the user creates:

- the Edit Access spans of each user associated with the format or range policy
- each span that is explicitly named in the rule

The span rules associated with a format or range policy take effect for new services only when the format or range policy is administratively enabled and has a valid configuration that includes at least one user or user group.

See [9.8 “How do I configure sample span rule?” \(p. 177\)](#) for a sample span rule configuration and implementation.

9.7 What is user activity logging?

9.7.1 Log records

The NFM-P logs each GUI and XML API user action, such as system access attempts and configuration changes in the main database. The following table lists the information in a user activity log record.

Table 9-2 User activity log record information

Field name	Description
Time	Time of activity
Session Type	Type of session, which is GUI, JMS, or XML API
Session ID	Client session identifier
Session IP Address	Client IP address
Session Time	Client session start time
Server IP Address	IP address of main server that reports the activity
Type	General activity type, which is Deployment, Operation, or Save
Sub Type	Specific activity type, which is Creation, Deletion, Modification, or name of the invoked method
Username	NFM-P username
Site Name	Name of affected NE, if applicable

Table 9-2 User activity log record information (continued)

Field name	Description
Site ID	IP address of affected NE, if applicable
Object Name	Name of affected object
Object ID	Fully qualified name of affected object
Object Type	Type of affected object
State	Activity status, which is Failure, Success, or Timeout
Request ID	Identifier assigned to the request, which is unique to a session
Additional Info	Information such as old and new parameter values after a modification
XML	NFM-P object class descriptor, if applicable, and activity details in XML request format

To view general user activity log entries in the GUI, or retrieve the entries using the XML API, you require an NFM-P user account that has the Administrator or NFM-P Management and Operations scope of command role.

You can also enable the forwarding of user activity logs to a remote syslog server, as described in [9.7.2 “Remote syslog server forwarding” \(p. 175\)](#).

i **Note:** Viewing or retrieving LI user activity entries requires the Lawful Intercept Management role, and is restricted to the entries of users in the same LI user group.

The logged activity types are the following:

- Operation—a request for the NFM-P
- Deployment—a change that is deployed to an NE
- Save—a change to an object in the NFM-P database

Each user activity creates an Operation log entry. If the activity results in an NE configuration change, a Deployment entry is logged. If the deployed information differs from the information in the NFM-P database, a Save entry is logged. If appropriate, a log entry contains the activity details in XML format.

The following table lists the user activity types and describes the associated sub types.

Table 9-3 User activity types

Type	Sub Type	sub type description
Deployment	Creation	NE object creation
	Deletion	NE object deletion
	Modification	NE object modification
Operation	<i>method</i>	Name of invoked method

Table 9-3 User activity types (continued)

Type	Sub Type	sub type description
Save	Creation	Database object creation
	Deletion	Database object deletion
	Modification	Database object modification

The User Activity form displays a filterable list of the logged user activities, and a filterable list of the logged client and server session activities. Client session activities include connection, disconnection, and access violation. Server session activities include startup and shutdown. The properties form of a client connection log record lists the activities performed by the user during the client session.

The client GUI allows direct navigation between the following objects:

- activity record and the associated session record
- activity record and the activity target object
- object properties form and the associated user activity list form
- NFM-P Task Manager task and the associated user activity list form
- session record and the associated user activity list form

The User Activity form lists the recent user session and activity entries; older entries are purged according to configurable storage criteria. See [21.11 “How do I set the NFM-P system preferences?” \(p. 526\)](#) for information about configuring the user activity log retention criteria using the System Preferences form.

To archive user activity log entries before the entries are purged from the NFM-P database, an XML API client can use a time-based filter to retrieve entries from the sysact package using the find and findToFile methods. See “Inventory retrieval methods” in the *NSP NFM-P XML API Developer Guide* for information about using the find and findToFile methods.

User activity logging is a valuable troubleshooting function. For example, if a port unexpectedly fails, you can quickly determine whether misconfiguration is the cause by doing one of the following:

- opening the port properties form and clicking User Activity to view the recent user activity associated with the port
- opening the User Activity form, filtering the list by object type or name, and then verifying the associated user activities



Note: Script execution is logged, but the actions that a script performs are not.

The following apply to user activity logging.

- A Deployment activity typically does not have an associated Save activity for the following reasons:
 - A Deployment activity takes place only after a successful Save activity, so a Deployment implies a Save.
 - A Save activity typically contains the same information as the associated Deployment activity.
- When a high-level object such as an NE is deleted, one aggregate activity record is created, rather than multiple NE child object activity records.

- The XML text in a log entry is limited to 4000 characters. If an activity generates more than 4000 characters of XML text, the text is truncated, and the truncation is indicated on the log entry form.

9.7.2 Remote syslog server forwarding

You can enable the forwarding of NFM-P user activity logs to a remote syslog server by specifying the target server parameters for **remote-syslog** using the NFM-P samconfig utility on a main server.

Each generated remote syslog message for user activity has the following fields:

- timestamp
- hostname of syslog producer
- program name
- User Activity Log message

The User Activity Log message is in JSON format, and includes the following:

User Activity Log syslog record example

The following is an example of an NFM-P User Activity Log record forwarded to a remote syslog server.

```
May 27 17:30:57 nfmp-mainserver-1 activitylogs: {"app":"NFM-P",
"clientHost":"203.0.113.7","reqMethod":"Save","addlParams":"{}",
"actionParams":[
], "respCodePhrase":"Success", "timeStamp":"2020-05-27 17:30:56.330
+0530", "affObjs": [
{"val":"securityManager", "key":"fdn"}
,
{"val":"TSecurity Manager", "key":"objectType"}
,
{"val":"0.0.0.0", "key":"siteId"}
,
{"val":"0.0.0.0", "key":"siteName"}
], "uid":"154", "host":"203.0.113.7", "action":"Modification", "user":
"admin", "reqURL":"N/A", "respCode":"1"}
```

The fields in the example have the following values:

i **Note:** In an NFM-P log record, the addlParams field is always empty, and the reqURL field always contains “N/A”.

- timestamp—May 27 17:30:57
- hostname of syslog entry producer—nfmp-mainserver-1
- program name—activitylogs
- User Activity Log entry—remainder that begins with "app":"NFM-P"

-
- app—function name from which action performed
 - clientHost—remote hostname or IP address that invokes action
 - reqMethod—type of action performed
 - actionParams—array; contains parameters passed to action
 - addIPParams—array; contains parameters or other such values not in other fields; always empty in NFM-P record
 - respCodePhrase—human-readable action response code
 - timeStamp—time at which action completed
 - affObjs—array of affected-object attributes, for example, FDN and ID
 - uid—record ID
 - host—IP address of syslog entry producer
 - action—name of action performed
 - user—username under which action performed
 - reqURL—HTTP URL of the executed HTTP Request; always contains “N/A” in NFM-P record
 - respCode—action response code, in integer format

9.7.3 Client session control

Each GUI or XML API client request creates an NFM-P client session. You can view a list of the active client sessions on the Sessions tab of the NFM-P User Security - Security Management form. Using this form, an admin user, or a user with an assigned Security scope of command role, can also terminate one or more client sessions. When a GUI client session is terminated in this manner, each client GUI displays a warning message and the connection is closed after a short delay. See [9.36 “How do I view and manage the active GUI client sessions?” \(p. 205\)](#) for more information.

Messaging connections

A list of active GUI connections and XML API JMS connections can be viewed on the Messaging Connections tab of the NFM-P User Security - Security Management form. Using this form, an admin user, or a user with an assigned Security scope of command role, can terminate one or more connections. When an XML API client connection is terminated, a notification is sent to the client, but the admin user must also remove the JMS client connection so that the server stops storing JMS messages for the session. See [9.37 “How do I disconnect an XML API JMS client connection or remove a durable subscription?” \(p. 205\)](#) for more information.

Client delegate sessions

The threshold for the number of client sessions allowed on a client delegate server is configurable from the client GUI. When a user tries to open a client session that exceeds the threshold, the client delegate server opens the session, displays a warning message, and generates an alarm. The threshold-crossing function can help to balance the session load across multiple client delegate servers. You need the Update user permission on the Server package to configure the threshold. See [9.41 “How do I configure the number of allowed client sessions for a client delegate server?” \(p. 210\)](#) for more information.

9.8 How do I configure sample span rule?

9.8.1 Overview

This section describes the configuration of a policy that instructs the NFM-P to automatically add each service created for a specific customer to an Edit Access span associated with the creator of the service. Only the service administrator for the customer can create or edit the specific customer services. In contrast, a typical service user can only view the specific customer services. The following table describes the tasks to configure a span rule.

Table 9-4 Sample span rule configuration

Task	Description
1. Create a span that contains the existing customer services.	<ul style="list-style-type: none"> Choose Administration→Security→NFM-P User Security from the NFM-P main menu. Choose Create→Span on the Span of Control tab. Specify a span name for the customer services. Use the Contents tab to specify the customer X services.
2. Create a span of control profile for the service administrator.	<ul style="list-style-type: none"> Choose Administration→Security→NFM-P User Security from the NFM-P main menu. Choose Create→Profile on the Span of Control tab. Add the Default Service Span as a View Access span to the span of control profile, which allows the user to create a service. Add the customer services span as an Edit Access span to the span of control profile.
3. Create a range policy for each service type that the service administrator for the customer can create. In the sample, the services are IES and VPRN.	<ul style="list-style-type: none"> Choose Administration→Format and Range from the NFM-P main menu. Choose Create→Range Policy. Specify IES Service as the Object Type. Specify Service ID as the Property Name. Configure a range. Click Add on the Users tab to assign the policy to the service administrator. Choose Create→Range Policy. Specify VPRN Service as the Object Type. Specify Service ID as the Property Name. Configure a range. Click Add on the Users tab to assign the policy to the service administrator.
4. Create a span rule that contains the customer span.	<ul style="list-style-type: none"> Choose Administration→Span Rules from the NFM-P main menu. Specify a name for the customer span rule. Set the Created In parameter to All listed spans. Add the customer span on the Spans tab.

After the span rule is created, the service administrator creates a new VPRN service for the customer. The NFM-P uses the VPRN range policy to automatically configure the service ID, and applies the associated customer span rule when the service is saved. As a result, the service is added to the customer span and to the Default Service Span. The service administrator has Edit Access to the customer span, and, therefore, can modify the service, as required.

9.9 What is remote NFM-P user access?

9.9.1 Remote user access overview



CAUTION

Security Risk

Using unsecure LDAP for remote authentication poses a great security risk.

If you intend to use LDAP for remote access, it is strongly recommended that you use only a server that uses secure LDAP, or LDAPS.

In addition to local account management, NFM-P user authentication and authorization can be accomplished via remote servers. The NFM-P supports the following remote user access protocols:

- LDAP/S—unsecured / secured LDAP
- RADIUS
- TACACS+

Functional description

You can configure NFM-P access for users that log in through a third-party server in a corporate network. For example, a person who does not have an NFM-P user account can log in to the NFM-P using their corporate credentials. The NFM-P forwards the credentials to a remote authentication server, and grants or denies access to the user based on the remote server response.

If a remote authentication server is configured to authorize users, the remote server also sends the name of a user group in a successful authentication response. If the NFM-P has a user group with the same name, the user is assigned to the group and granted access based on the group properties. Otherwise, the user is assigned to a default external user group.

When a remote session terminates, the associated NFM-P user account remains, and the user preferences, such as filters, apply to subsequent sessions.

Successful remote authentication for an XML API user requires that the remote server and the NFM-P use the same password format. The XML API users can log in using a clear-text or MD5-hashed password, if the remote server supports MD5 password hashing. See “Secure communication” in the *NSP NFM-P XML API Developer Guide* for more information.

Configuration

You use the NFM-P Remote Authentication Manager to configure the protocols and define the authentication order for users. For example, if you specify an order of RADIUS, LDAP, local, the NFM-P tries to authenticate each remote user via RADIUS; if the RADIUS servers are unavailable, the NFM-P tries LDAP, and upon failure tries to match the user credentials to a local NFM-P account.

[9.45 “How do I configure NFM-P remote user authentication?” \(p. 217\)](#) describes how to configure the general remote access properties, such as the authentication types, the authentication order, and the remote servers.

9.9.2 Assigning remote users to NFM-P user groups

User authorization is the assignment of a user to a user group after successful user authentication. By default, the NFM-P assigns a remote user to a default user group, if one is specified. Optionally, you can configure the NFM-P to assign a group specified by a remote server. If no default group is specified, and remote group assignment is not configured, the authorization fails and the user is denied access.

After a remote server authenticates a user, if the name of the user group sent by the remote server matches an NFM-P user group name, the NFM-P creates a user account for the login session and grants the appropriate access rights. Otherwise, authorization fails and the NFM-P denies user access.

RADIUS or TACACS+ user authorization

In order for a remote RADIUS or TACACS+ server to assign an NFM-P user group, you must preconfigure the NFM-P and the remote server. See [9.43 “How do I enable remote user authorization via RADIUS?” \(p. 212\)](#) for information about enabling authorization for RADIUS users, and [9.44 “How do I enable remote user authorization via TACACS+?” \(p. 215\)](#) for information about enabling authorization for TACACS+ users.

i **Note:** A RADIUS authentication success message that is sent to the NFM-P contains the user group name.
For TACACS+, authentication must succeed before an authorization message containing the user group name is sent to the NFM-P.

LDAP/S user authorization

For each LDAP or LDAPS server that you specify using the NFM-P Remote Authentication Manager, you can include LDAP group lookup criteria. The group name that the LDAP server returns in an authentication success message must match an existing NFM-P group name.

i **Note:** Microsoft Windows Active Directory uses LDAP or LDAPS as an underlying protocol.

9.9.3 One-time password use

For increased security, a GUI user can provide an authentication token to an LDAP, RADIUS or TACACS+ server that is validated only once. You can enable one-time password use during NFM-P remote authentication policy configuration, as described in [9.45 “How do I configure NFM-P remote user authentication?” \(p. 217\)](#).

i **Note:** The one-time password function is not available to XML API clients.
To change the one-time password setting in a remote authentication policy, you require a scope of command that has Update/Execute access to the srmrmtauth package.

After a communication failure between a GUI client and a main server when one-time password use is in effect, the GUI client is unable to obtain authentication using the cached credentials from the previous login attempt. When this occurs, the client prompts the user to log in to the remote authentication server again, but does not automatically close the GUI, in order to preserve the current view until the user is authenticated.

9.9.4 Combined local and remote authentication

An NFM-P operator can integrate an existing LDAP, RADIUS, or TACACS+ user account with an NFM-P user account by creating an NFM-P user account that has the same name as the remote account. A remote NFM-P user can subsequently log in to the NFM-P using the remote credentials, if the password observes the NFM-P password constraints.

i **Note:** If the password of a remote user does not abide by the NFM-P password constraints, the NFM-P cannot authenticate the user.

An NFM-P user name:

- can include the following:
 - alphanumeric characters from 0 to 9, a to z, and A to Z
 - the following special characters: . - _ @
- must:
 - be 1 to 40 characters in length
 - begin with an alphanumeric character
 - not include a space character

i **Note:** If a RADIUS or TACACS+ server is configured to perform user authorization, the NFM-P requires a user group from the remote server, and the following conditions apply:

- The user group sent by the remote server must be defined in the NFM-P.
- If an NFM-P user account is associated with a local user group and configured to use remote authentication, the local user group is replaced by the specified remote user group.

For example, a user named jane has the following accounts:

- a remote RADIUS account called jane and the password accessforjane
- a local NFM-P account called jane and the password LetJane1In!

When jane is authenticated by RADIUS, she gains access to the NFM-P by typing in jane and accessforjane. If the RADIUS server is down, jane is authenticated locally by the NFM-P after typing jane and LetJane1In!.

9.10 Sample: how do I configure NFM-P user authentication?

9.10.1 Use case

[Figure 9-1, “Sample NFM-P user and user group authentication” \(p. 181\)](#) shows an example of how NFM-P performs user and user group authentication.

i **Note:** RADIUS and TACACS+ authentication servers support multiple users. If the NFM-P cannot reach the first authentication server, the NFM-P sequentially attempts the user authentication using the remaining authentication servers.

If user authentication fails against the first authentication server in a sequence, for example, because of an incorrect password, there is no attempt to authenticate the user against the next authentication server in the sequence.

The NFM-P session log records unsuccessful user authentication attempts for known and unknown users. A user that is defined on an external AAA server but not in the NFM-P.

Figure 9-1 Sample NFM-P user and user group authentication

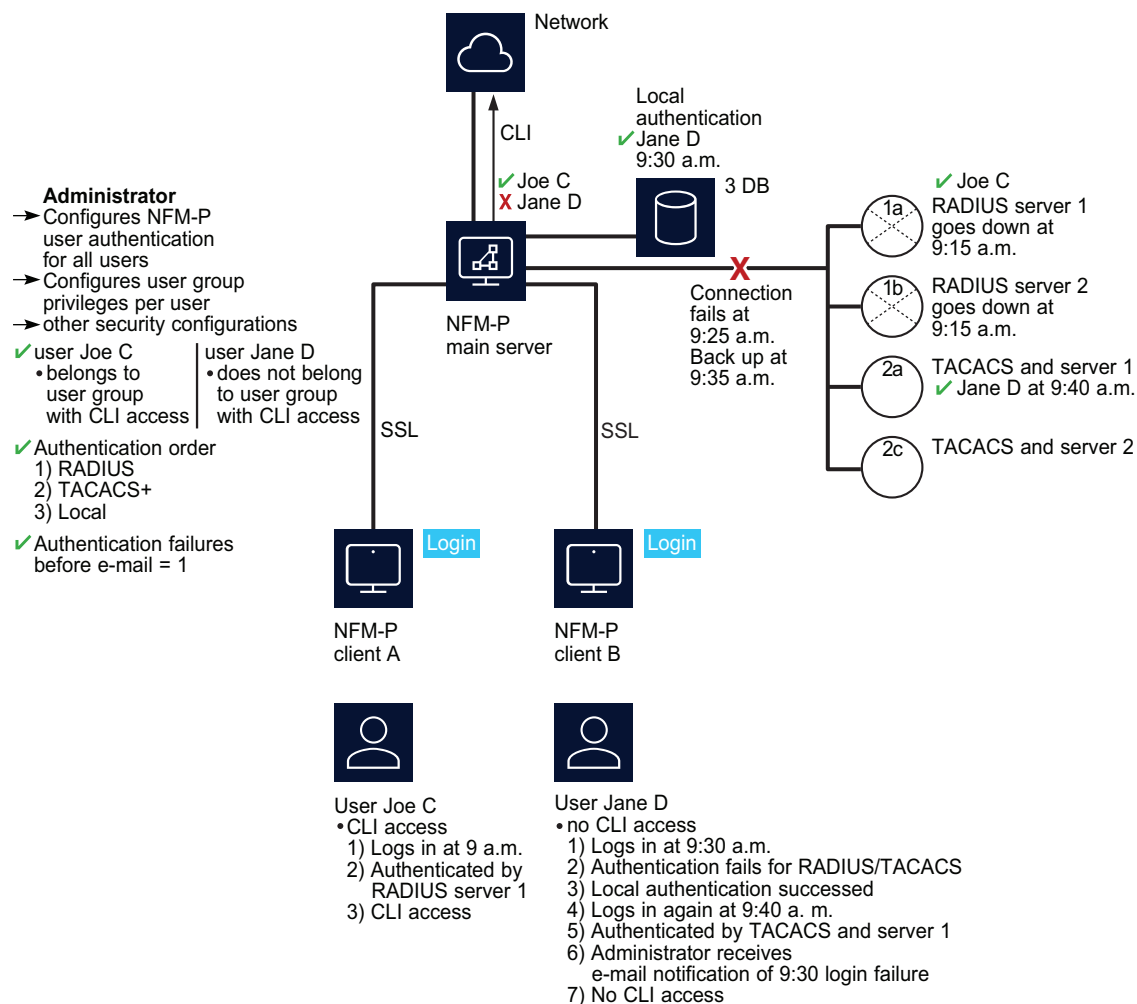

17770

The following table lists the high-level tasks required to configure this sample.

Table 9-5 Sample NFM-P user authentication configuration

Task	Description
Pre-configurations	Ensure correct RADIUS or TACACS+ server configuration, according to your company requirements. PAP authentication is supported for RADIUS and TACACS+. The NFM-P must be able to communicate with the authentication servers to validate users. All configuration tasks require admin user privileges. The NFM-P server IP address must be configured as the client of the RADIUS or TACACS+ server. The NFM-P and RADIUS or TACACS+ server secret keys must match.

Sample: how do I configure NFM-P user authentication?

Table 9-5 Sample NFM-P user authentication configuration (continued)

Task	Description
1. Configure the remote authentication order for all users	<p>Choose Administration→Security→NFM-P Remote User Authentication from the NFM-P main menu. Set the authentication order parameters to the following, and then specify the RADIUS and TACACS+ servers on the RADIUS and TACACS tabs.</p> <ul style="list-style-type: none"> • Authentication Order 1—radius • Authentication Order 2—tacplus • Authentication Order 3—local
2. Create scope of command profiles	<p>Choose Administration→Security→NFM-P User Security from the NFM-P main menu. Create a CLI scope of command profile and assign the default CLI management role to the profile. Create at least one scope of command profile that does not allow CLI access by assigning the <i>default</i> scope of command role, which has no access permissions to CLI management.</p>
3. Create and configure user groups	<p>Choose Administration→Security→NFM-P User Security from the NFM-P main menu. Create a CLI user group and at least one user group that does not allow CLI access. Assign the scope of command profile with CLI management access to the CLI user group. Assign the scope of command profile without CLI management access to the user group without CLI access. Authorization is done using user groups, so each user must belong to a user group with a local account on the NFM-P.</p>
4. Create and configure user accounts	<p>You can create local NFM-P user accounts by performing the following steps, or define remote users using RADIUS and TACACS+. The local accounts are available when RADIUS or TACACS+ authentication is not available.</p> <p>Choose Administration→Security→NFM-P User Security from the NFM-P main menu. Create users. Assign the appropriate user group to restrict or allow CLI access to each user.</p>
5. Configure notification	<p>Choose Administration→Security→NFM-P User Security from the NFM-P main menu. Configure the authentication failure action parameters, including the parameters that allow the e-mail account of the administrator to be notified after login failure.</p>

Consider the following:

- The NFM-P acts as a network access server. A network access server is considered a client of a remote access server.
- The sequence of activity between the NFM-P, which is the authentication client, and the remote server, which is the authentication server, is the following:
 - client requests authentication
 - server replies to authentication request
 - client requests logout and authentication stops
- When the remote authentication servers are down and local authentication is used, the user must log in using NFM-P credentials, as described in [9.9.4 “Combined local and remote authentication” \(p. 180\)](#).

9.11 Workflow: configure and manage NFM-P user security

9.11.1 Stages

- 1 _____
Assess the requirements for user access to the different NFM-P functional areas and develop a strategy for implementing user security. See [9.6 “How do I manage NFM-P user accounts and groups?” \(p. 167\)](#) for more information.
- 2 _____
Reserve a client GUI session for the admin user to ensure that the admin user can always log in; see [9.12 “How do I reserve an admin account login?” \(p. 186\)](#) .
- 3 _____
Create scope of command roles or modify the default role to meet your operational requirements; see [9.13 “How do I create a scope of command role?” \(p. 186\)](#) .
- 4 _____
Create scope of command profiles that contain the appropriate scope of command roles for the types of tasks to be performed; see [9.14 “How do I create a scope of command profile?” \(p. 187\)](#) .
- 5 _____
Create spans or modify the default span to meet your operational requirements. Add managed objects to the spans; see [9.15 “How do I create a span of control?” \(p. 188\)](#) .
- 6 _____
Create span of control profiles that contain the required spans; see [9.16 “How do I create a span of control profile?” \(p. 189\)](#) .
- 7 _____
Create span rules, as required, to automatically assign new services to spans other than the Default Service Span; see [9.17 “How do I create a span rule?” \(p. 189\)](#) .
- 8 _____
Manage user group security requirements, as required.
 - Create or modify user groups and assign scope of command and span of control profiles to each group, as required; see [9.18 “How do I create an NFM-P user group?” \(p. 190\)](#) .
 - Add workspaces to user groups; see [9.19 “How do I add or remove workspaces for a user group?” \(p. 192\)](#) .

9

Create, modify, or copy user accounts for performing the tasks that are associated with each user group; see [9.20 “How do I create an NFM-P user account?”](#) (p. 193) and [9.21 “How do I copy an NFM-P user account?”](#) (p. 195) .

10

Configure global user account parameters, as required.

- user-account expiry periods, password criteria, and a GUI inactivity timeout; see [9.22 “How do I configure global user account and password expiry?”](#) (p. 195) and [9.23 “How do I configure the GUI client inactivity timeout?”](#) (p. 196) .
- minimum username length; see [9.24 “How do I configure the minimum allowable user name length?”](#) (p. 197) .
- allowed number of authentication attempts; see [9.25 “How do I configure authentication failure actions?”](#) (p. 197) .
- suspended account actions; see [9.26 “How do I configure suspended account actions?”](#) (p. 198) .
- automated e-mail notification; see [9.27 “How do I configure automated E-mail notification?”](#) (p. 198) .

11

Configure global user activity logging, as required; see [21.11 “How do I set the NFM-P system preferences?”](#) (p. 526) .

12

Enable and configure NFM-P access for remote users, if required.

1. Configure authorization for remote users in which either the NFM-P or the remote authentication server associates the user with a user group:
 - for LDAP: [9.42 “How do I enable secure access for remote LDAP users?”](#) (p. 211)
 - for RADIUS: [9.43 “How do I enable remote user authorization via RADIUS?”](#) (p. 212)
 - for TACACS+: [9.44 “How do I enable remote user authorization via TACACS+?”](#) (p. 215)
2. Configure the general remote-access parameters, and specify LDAP, RADIUS, and TACACS+ servers, as required; see [9.45 “How do I configure NFM-P remote user authentication?”](#) (p. 217).

13

Manage user accounts, as required.

- List inactive user accounts; see [9.28 “How do I list inactive user accounts?”](#) (p. 199) .
- Suspend or reinstate user accounts; see [9.29 “How do I suspend or reinstate an NFM-P user account?”](#) (p. 199) .
- Manage passwords.
 - As administrator, change the password of an NFM-P user account; see [9.30 “How do I change an NFM-P user password?”](#) (p. 200) .

-
- Force a specified NFM-P user to change the account password during the next login attempt; see [9.31 “How do I disable an NFM-P user password?”](#) (p. 201) .
 - Change the account password of the current user; see [9.32 “How do I change the password of the current NFM-P user?”](#) (p. 202) .
 - Export user tab preferences; see [9.33 “How do I export the local tab preferences of one or more users?”](#) (p. 202) .
 - Assign user tab preferences; see [9.34 “How do I assign local tab preferences to users?”](#) (p. 203) .

14

Monitor and manage the active client sessions, as required.

- Broadcast a message to one or more GUI operators; see [9.35 “How do I send a broadcast message to GUI clients?”](#) (p. 204) .
- List and optionally close GUI client sessions; see [9.36 “How do I view and manage the active GUI client sessions?”](#) (p. 205) .
- List and optionally close XML API client sessions; see [9.37 “How do I disconnect an XML API JMS client connection or remove a durable subscription?”](#) (p. 205)
- View the NFM-P user activity logs to monitor GUI and XML API user activity; see [9.38 “How do I view the user activity log?”](#) (p. 206) and [9.39 “How do I view the user activity associated with an object?”](#) (p. 208) .

15

Configure or manage the following security functions, as required:

- Change the maximum number of concurrent NFM-P admin user sessions; see [9.40 “How do I change the maximum number of concurrent NFM-P admin operator positions?”](#) (p. 209) .
- Limit the number of client sessions that the NFM-P accepts from one or more client delegate servers; see [9.41 “How do I configure the number of allowed client sessions for a client delegate server?”](#) (p. 210) .

16

Change the default parameter setting for the Task Manager, as required; see [9.46 “How do I change the NFM-P Task Manager settings?”](#) (p. 219) .

17

Export or import all workspaces and tab preferences, as required.

- Export all workspaces and tab preferences; see [9.47 “How do I export all workspaces and local tab preferences?”](#) (p. 221) .
- Import all workspaces and tab preferences, import workspaces only, or import tabs only; see [9.48 “How do I import workspaces and local tab preferences?”](#) (p. 221) .

9.12 How do I reserve an admin account login?

9.12.1 Purpose

You can reserve one client GUI session for administrative users only. This allows an administrator to manage the existing client GUI sessions. You must have an account with an assigned Security scope of command role to perform this procedure.

9.12.2 Steps

- 1 _____
Choose Administration→Security→NFM-P User Security from the NFM-P main menu. The NFM-P User Security - Security Management (Edit) form opens.
- 2 _____
Configure the Reserve Administrator Login parameter.
- 3 _____
Save your changes and close the form.
- 4 _____
Log in as required.

END OF STEPS _____

9.13 How do I create a scope of command role?

9.13.1 Purpose

You can create a set of user permissions that define an operator role and apply one or more scope of command roles to a user group using a scope of command profile. You must have an account with an assigned Security scope of command role to perform this procedure.

i **Note:** You cannot delete a predefined scope of command role.

You cannot delete a scope of command role that is assigned to a scope of command profile when the scope of command profile is assigned to a user group that contains users.

Refer to [Appendix A, “Classic management scope of command roles and permissions”](#) for a complete list of command profiles, roles, and permission information.

9.13.2 Steps

- 1 _____
Using an account with an assigned Security scope of command role, choose Administration→Security→NFM-P User Security from the NFM-P main menu. The NFM-P User Security - Security Management (Edit) form opens.

-
- 2 _____
Click on the Scope of Command tab.
 - 3 _____
Click Create and choose Role. The Role (Create) form opens.
 - 4 _____
Configure the required parameters.
 - 5 _____
Configure the permissions for the scope of command role:
 1. Click on the Permissions tab. A list of the NFM-P packages, classes, and methods is displayed.
 2. Select the required access permissions, which are displayed in the list column headings, for each package, class, or method that you need to assign to the scope of command role.
 - 6 _____
Save your changes and close the form.

END OF STEPS _____

9.14 How do I create a scope of command profile?

9.14.1 Steps

- 1 _____
Using an account with an assigned Security scope of command role, choose Administration→Security→NFM-P User Security from the NFM-P main menu. The NFM-P User Security - Security Management (Edit) form opens.
- 2 _____
Click on the Scope of Command tab.
- 3 _____
Click Create and choose Profile. The Scope of Command Profile (Create) form opens.
- 4 _____
Configure the required parameters.
- 5 _____
Assign one or more scope of command roles to the profile:
 1. Click on the Roles tab and click Add. The Select Role - Role form opens.

-
2. Select one or more roles and click OK.

Note: You cannot delete a scope of command profile that is assigned to a user group that contains users.

6

Save your changes and close the form.

END OF STEPS

9.15 How do I create a span of control?

9.15.1 Purpose

You can specify a set of NFM-P objects in a span of control and the type of user access available for the objects. You can apply one or more spans to a user group using a span of control profile. You must have an account with an assigned Security scope of command role to perform this procedure.



Note: You cannot delete a span of control that is assigned to a user group that contains users.

9.15.2 Steps

1

Using an account with an assigned Security scope of command role, choose Administration→Security→NFM-P User Security from the NFM-P main menu. The NFM-P User Security - Security Management (Edit) form opens.

2

Click on the Span of Control tab.

3

Click Create and choose Span. The Span (Create) form opens.

4

Configure the required parameters.

5

Add one or more objects for user access:

1. Click on the Contents tab.
2. Click Add and choose an object type. The Select (*object_type*) form opens.
3. Select one or more objects and click OK.

-
- 6 _____
Save your changes and close the form.

END OF STEPS _____

9.16 How do I create a span of control profile?

9.16.1 Steps

- 1 _____
Using an account with an assigned Security scope of command role, choose Administration→Security→NFM-P User Security from the NFM-P main menu. The NFM-P User Security - Security Management (Edit) form opens.
- 2 _____
Click on the Span of Control tab.
- 3 _____
Click Create and choose Profile. The Span of Control Profile (Create) form opens.
- 4 _____
Configure the required parameters.
- 5 _____
Assign one or more spans to the profile:
1. Click on the Spans tab. The predefined spans are listed.
 2. Click Add and choose an access type. The Select *access_type* Spans form opens.
 3. Select one or more spans in the list and click OK.
- Note:** You cannot delete a span of control profile that is assigned to a user group that contains users.
- 6 _____
Save your changes and close the form.

END OF STEPS _____

9.17 How do I create a span rule?

9.17.1 Purpose

A span rule is a policy that specifies to which span of control profiles, in addition to the Default Service Span, a newly created service is automatically assigned. You must have an account with an assigned Security scope of command role to perform this procedure.

See [9.8 “How do I configure sample span rule?” \(p. 177\)](#) for a sample span rule configuration and implementation.

9.17.2 Steps

- 1 _____
Using an account with an assigned Security scope of command role, choose Administration→Span Rules from the NFM-P main menu. The Span Rules form opens.
- 2 _____
Click Create. The Service Creation Span Rule (Create) form opens.
- 3 _____
Configure the required parameters.
- 4 _____
Associate one or more spans with the rule:
 1. Click on the Spans tab and click Add. The Select Span(s) form opens.
 2. Select one or more spans in the list and click OK.
- 5 _____
Associate one or more format or range policies with the rule:
 1. Click on the Format and Range Policies tab and click Add. The Select Format or Range Policies form opens.
 2. Select one or more policies in the list and click OK.
- 6 _____
Save your changes and close the form.

END OF STEPS _____

9.18 How do I create an NFM-P user group?

9.18.1 Steps

- 1 _____
Using an account with an assigned Security scope of command role, choose Administration→Security→NFM-P User Security from the NFM-P main menu. The NFM-P User Security - Security Management (Edit) form opens.
- 2 _____
Click on the User Groups tab and click Create. The User Group (Create) form opens.

-
- 3 _____
Configure the required general parameters.
 - 4 _____
Enable and configure the Maximum User Group Operator Positions Allowed parameter to specify the maximum number of operator positions for the user group, where one operator position allows for one NFM-P non-web client session and one web client session for the user group.
 - 5 _____
Configure the parameters in the Expiry Periods panel.
 - 6 _____
If the user group is for remote XML API users, configure the required parameters in the Remote Users panel.
 - 7 _____
Select a scope of command profile in the Scope of Command panel.
 - 8 _____
Select a span of control profile in the Span of Control panel.
 - 9 _____
If you are modifying a user group, click on the Format and Range Policies tab. The Select Format or Range Policies form opens.
 - 10 _____
Select one or more policies and click OK.

 **Note:** When you change the scope of command or span of control profiles of a group, the permissions of each user in the group are altered immediately when you click OK. You cannot delete a user group that contains users.
 - 11 _____
Save your changes and close the form.
 - 12 _____
If an active client session is affected by the user group modification, restart the client.

END OF STEPS _____

9.19 How do I add or remove workspaces for a user group?

9.19.1 Steps

An NFM-P administrator can use this procedure to set conditions so that either users cannot change the list of workspaces on their User Preferences form or users can add additional workspaces to their workspace selector. To create or add new workspaces for a user group, see “NFM-P GUI custom workspace procedures” in the *NSP NFM-P User Guide* for more information.

1

Choose Administration→Security→NFM-P User Security from the NFM-P main menu. The NFM-P User Security - Security Management (Edit) form opens.

2

Click on the User Groups tab.

3

Click Create or choose a user group and click Properties. The User Group (Create|Edit) form opens.

4

To configure the Allow Mandatory Workspaces Only parameter in the Mandatory Workspaces panel, choose one of the following!:

a. Select the Allow Mandatory Workspaces Only check box.



Note: If you select the Allow Mandatory Workspaces Only check box, the Add button on the User Preferences→Workspaces form is dimmed and the user cannot change the list of workspaces on their User Preferences form.

Any existing user-defined workspaces in the User Preferences form are deleted when the Allow Mandatory Workspaces Only check box is selected.

The user can change the order that the workspaces appear in the workspace selector and set any workspace as the default workspace.

b. Deselect the Allow Mandatory Workspaces Only check box.



Note: The user can add additional workspaces to their workspace selector by clicking Add in the User Preferences form. See “NFM-P GUI custom workspace procedures” in the *NSP NFM-P User Guide* for more information.

The user can change the order that the workspaces appear in the workspace selector and set any workspace as the default workspace.

5

Add mandatory workspaces to a specific user group:

1. Click Add. The Add Workspace form opens.

2. Choose a workspace from the list and click OK. The Add Workspace form closes.

Note: All mandatory workspaces that are added to the user group by the administrator appear in the User Preferences→Workspaces form and in the workspace selector drop-down for each user in the user group and cannot be deleted.

6

To remove a workspace from the user group, choose a workspace in the Mandatory Workspaces panel and click Delete.

7

Click Move Up or Move Down to reorder the workspaces in the list. The workspace at the top of the list is the default workspace.



Note: You need a minimum of one workspace in the User Group.

If the last user workspace is deleted, the users default workspace in the User Preferences form is replaced by the user group default workspace.

8

Save your changes and close the form.

END OF STEPS

9.20 How do I create an NFM-P user account?



Note: If you want to delete an NFM-P user account, schedules associated with the user account are deleted only if the schedule is not associated with a scheduled task.

9.20.1 Steps

1

Using an account with an assigned Security scope of command role, choose Administration→Security→NFM-P User Security from the NFM-P main menu. The NFM-P User Security - Security Management (Edit) form opens.

2

Click on the Users tab and click Create. The User (Create) form opens.

3

Configure the required general parameters.

4

Click Select and choose a user group.

5

If required, test the validity of the user e-mail address by clicking Test e-mail beside the e-mail Address parameter.



Note: Before you test the validity of the user address, ensure that the outgoing SMTP server and test message are configured. See [9.27 “How do I configure automated E-mail notification?” \(p. 198\)](#) for information about configuring the outgoing server and test message.

6

Configure the parameters in the Password panel.

7

In the UI Session panel, configure the Maximum User Operator Positions Allowed parameter to specify the maximum number of operator positions for the user, where one operator position allows for one NFM-P non-web client session and one web client session for the user.

The value for the Maximum User Operator Positions Allowed parameter cannot be greater than the Maximum User Group Operator Positions Allowed parameter value of the user group to which the user belongs.



Note: When two or more sessions of the same type are registered from a user ID, two or more operator positions are consumed.

8

To enable XML API client access:

1. Configure the required parameters in the OSS Session panel.
2. To apply an alarm filter to control or limit the alarms that the NFM-P forwards to XML API clients over JMS, click Select in the OSS Session panel and choose an alarm filter. See [21.32 “How do I configure alarm filters for XML API clients?” \(p. 557\)](#) for more information.

9

Configure the required parameters in the Client IP Address panel.

10

Save your changes and close the form.

END OF STEPS

9.21 How do I copy an NFM-P user account?

9.21.1 Steps

- 1 _____
Using an account with an assigned Security scope of command role, choose Administration→Security→NFM-P User Security from the NFM-P main menu. The NFM-P User Security - Security Management (Edit) form opens.
- 2 _____
Click on the Users tab.
- 3 _____
Choose a user and click Properties. The User *type_of_user*, Group *user_group* (Edit) form opens.
- 4 _____
Click Copy. A User (Create) form opens for the second user.
- 5 _____
Configure the required parameters. You must change the User Name parameter and configure the User Password and Confirm Password parameters.
- 6 _____
Save your changes and close the form.

END OF STEPS _____

9.22 How do I configure global user account and password expiry?

9.22.1 Steps

- 1 _____
Using an account with an assigned Security scope of command role, choose Administration→Security→NFM-P User Security from the NFM-P main menu. The NFM-P User Security - Security Management (Edit) form opens.
- 2 _____
Configure the Password Reuse Cycle and Password History Duration (days) parameters.
- 3 _____
Configure the required parameters in the Expiry Periods panel.



Note: If you set any of the parameters to 0, the corresponding expiry period check is disabled.

You can specify how long an account can remain dormant before the account is locked using the Account Expiry (days) parameter.

When a user attempts to log in with an expired password, the user account is suspended.

When a user updates their password, the password expiry period is reset, and the new password again expires when the Password Expiry (days) parameter value is reached.

4

Save your changes and close the form.

END OF STEPS

9.23 How do I configure the GUI client inactivity timeout?

9.23.1 Steps

1

Choose Administration→Security→NFM-P User Security from the NFM-P main menu. The NFM-P User Security - Security Management (Edit) form opens.

2

Change the GUI inactivity check for all GUI clients.

1. Configure the Non-Web Client Timeout (minutes) parameter.
2. Click Apply.

3

Change the GUI inactivity check for all users in a user group:

1. Click on the User Groups tab. A list of user groups is displayed.
2. Choose a user group from the list and click Properties. The User Group *name* (Edit) form opens.
3. Enable the Non-Web Override Global Timeout parameter.
4. Configure the Non-Web Client Timeout (minutes) parameter.

4

Save your changes and close the form.

END OF STEPS

9.24 How do I configure the minimum allowable user name length?

9.24.1 Steps

The minimum number of characters for a user name length is one, and the maximum number of characters is 40.

1 _____

Using an account with an assigned Security scope of command role, choose Administration→Security→NFM-P User Security the NFM-P main menu. The NFM-P User Security - Security Management (Edit) form opens.

2 _____

In the User Name panel, check the Enable box.

3 _____

Configure the Minimum User Name Length Allowed parameter.

4 _____

Save your changes and close the form.

END OF STEPS _____

9.25 How do I configure authentication failure actions?

9.25.1 Purpose

You can specify an authentication message or a lockout for a user account that exceeds the configured number of login authentication attempts. Only non-admin accounts can be locked out. Admin accounts always have access.

9.25.2 Steps

1 _____

Using an account with an assigned Security scope of command role, choose Administration→Security→NFM-P User Security the NFM-P main menu. The NFM-P User Security - Security Management (Edit) form opens.

2 _____

Click on the E-mail tab and configure the required parameters in the Authentication Failure Actions panel.

If you set the Attempts before lockout parameter to 0, the lockout function is disabled.

-
- 3 _____
Save your changes and close the form.

END OF STEPS _____

9.26 How do I configure suspended account actions?

9.26.1 Steps

- 1 _____
Using an account with an assigned Security scope of command role, choose Administration→Security→NFM-P User Security the NFM-P main menu. The NFM-P User Security - Security Management (Edit) form opens.
- 2 _____
Click on the E-mail tab.
- 3 _____
Configure the parameters in the Suspended Account Actions panel.
- 4 _____
Save your changes and close the form.

END OF STEPS _____

9.27 How do I configure automated E-mail notification?

9.27.1 Purpose

You can configure the NFM-P to automatically send E-mail messages to users and administrators; for example, when locking out a user account that exceeds the allowed number of authentication attempts.

9.27.2 Steps

- 1 _____
Using an account with an assigned Security scope of command role, choose Administration→Security→NFM-P User Security the NFM-P main menu. The NFM-P User Security - Security Management (Edit) form opens.
- 2 _____
Click on the E-mail tab.

-
- 3 _____
Configure the required parameters in the Outgoing E-mail Server SMTP panel.
 - 4 _____
Configure the Test Message parameter.
 - 5 _____
Save your changes and close the form.

END OF STEPS _____

9.28 How do I list inactive user accounts?

9.28.1 Steps

- 1 _____
Choose Administration→Security→NFM-P User Security from the NFM-P main menu. The NFM-P User Security - Security Management (Edit) form opens.
- 2 _____
Click on the Users tab.
- 3 _____
Click Inactive User Search and perform one of the following:
 - a. Choose ≥90 Days.
 - b. Choose ≥180 Days.
 - c. Specify another period:
 1. Choose Custom User Inactivity Period. The Custom User Inactivity Period form opens.
 2. Configure the User inactive greater than or equal to parameter.User accounts that have been inactive for a number of days that are greater than or equal to the specified value are listed on the NFM-P User Security - Security Management (Edit) form.
- 4 _____
Save your changes and close the form.

END OF STEPS _____

9.29 How do I suspend or reinstate an NFM-P user account?

9.29.1 Steps

- 1 _____

Choose Administration→Security→NFM-P User Security from the NFM-P main menu. The NFM-P User Security - Security Management (Edit) form opens.

2

Click on the Users tab.

3

Select a user account and click Properties. The User *type_of_user* (Edit) form opens.

4

Configure the User State parameter to suspend or reinstate the user account.

5

Save your changes and close the form.

END OF STEPS

9.30 How do I change an NFM-P user password?

9.30.1 Purpose

An NFM-P administrator uses the Security Management form to maintain user accounts. An NFM-P operator can change their password from a separate form. If an operator forgets a password, an administrator can change the password for the operator.

When a user attempts to log in with an expired password, the user account is suspended. When a user updates their password, the password expiry period is reset, and the new password again expires when the Password Expiry (days) parameter value is reached.

9.30.2 Steps

1

Choose Administration→Security→NFM-P User Security from the NFM-P main menu. The NFM-P User Security - Security Management (Edit) form opens.

2

Click on the Users tab.

3

Select a user and click Properties. The User *type_of_user* (Edit) form opens.

4

Configure the User Password parameter and the Confirm Password parameter.

-
- 5 _____
Save your changes and close the form.

END OF STEPS _____

9.31 How do I disable an NFM-P user password?

9.31.1 Purpose

You can disable the password of a specific NFM-P user in order to block subsequent login attempts by forcing a password change.

i **Note:** Disabling a user password may affect current user sessions. For example, if the user attempts to open the NFM-P client when the password is invalidated, the user may be directed back to the NSP sign-in page. The operation fails until a valid password is assigned to the user.

9.31.2 Steps

- 1 _____
Open an NFM-P GUI client.
- 2 _____
Choose Administration→Security→NFM-P User Security from the main menu. The NFM-P User Security - Security Management (Edit) form opens.
- 3 _____
Click on the Users tab.
- 4 _____
Select a user and click Properties. The User *username* (Edit) form opens.
- 5 _____
Select the Force User Password Change parameter.
- 6 _____
Save your changes and close the form.
The next login attempt by the user is blocked, and the following message is displayed to the operator:

```
Your account password has expired and must be changed.
```

The operator must request a password from an administrator.



Note: To enable a password that you assign, you must deselect the Force User Password Change parameter.

END OF STEPS

9.32 How do I change the password of the current NFM-P user?

9.32.1 Steps

1

Open an NFM-P GUI client.

2

Choose Administration→Security→Change Password from the main menu. The Password Change form opens.

3

Configure the parameters.

4

Save your changes and close the form.

END OF STEPS

9.33 How do I export the local tab preferences of one or more users?

9.33.1 Purpose

You can export the local tab preferences of single or multiple users to a specified directory. You can reuse these saved tab preferences settings by importing them later.

The exported settings are the local tab preferences saved for the selected users, not the custom tab preferences saved in a workspace. See “To configure tab preferences” in the NSP *NFM-P User Guide* for information about saving tab preferences in a workspace.

9.33.2 Steps

1

Choose Administration→Security→NFM-P User Security from the NFM-P main menu. The NFM-P User Security - Security Management (Edit) form opens.

2

Click on the Users tab.

-
- 3 _____
Choose one or more users from the list.
 - 4 _____
Click Tab Preferences and choose Export to export the selected user's local tab preferences to a specified directory. The Export Directory window opens.
 - 5 _____
Specify the export directory, or create a directory or folder, and click OK. The selected user's local tab preferences are exported to the specified directory.
 - 6 _____
Close the form.

END OF STEPS _____

9.34 How do I assign local tab preferences to users?

9.34.1 Steps

- 1 _____
Choose Administration→Security→NFM-P User Security from the NFM-P main menu. The NFM-P User Security - Security Management (Edit) form opens.
- 2 _____
Click on the Users tab.
- 3 _____
Choose one or more users from the list.
- 4 _____
Click Tab Preferences and choose Assign to assign the tab preferences from the specified directory to the selected users. The Import Directory window opens. To export local tab preferences to a specified directory, see [9.33 "How do I export the local tab preferences of one or more users?" \(p. 202\)](#) .
- 5 _____
Navigate to the directory from which you need to assign a tab preference.

 **Note:** Only a single user's tab preferences can be in the specified directory or an error message appears.

How do I send a broadcast message to GUI clients?

6

Click Open and click Yes. The assigned tab preferences overwrite the local tab preferences of the selected users.

All affected users who currently have a client session opened, other than the client session where the assign has been initiated, receive a system-generated message informing them that the local tab preferences have been changed and they must restart the client, or risk losing the changes. A client operator can use the Reply function to reply to the message.

7

Close the forms.

END OF STEPS

9.35 How do I send a broadcast message to GUI clients?

9.35.1 Steps

1

Using an account with an assigned Security scope of command role, choose Administration→Security→NFM-P User Security from the NFM-P main menu. The NFM-P User Security - Security Management (Edit) form opens.

2

Click on the Sessions tab.

3

Select the required client session and click Text Message. The Text Message form opens.

4

Enter a message in the Text Message form and click Send.

5

Close the form.

END OF STEPS

9.36 How do I view and manage the active GUI client sessions?

9.36.1 Steps

1

Using an account with an assigned Security scope of command role, choose Administration→Security→NFM-P User Security from the NFM-P main menu. The NFM-P User Security - Security Management (Edit) form opens.

2

Click on the Sessions tab.

3

Specify a filter to create a filtered list of GUI or XML API JMS client sessions and click Search. The active client sessions are listed.

4

Review the session information.

5

To close a GUI client session, select a session in the list and click Close Session.



Note: Closing an XML API session has additional dependencies; see [9.37 “How do I disconnect an XML API JMS client connection or remove a durable subscription?”](#) (p. 204) for more information.

6

Close the form.

END OF STEPS

9.37 How do I disconnect an XML API JMS client connection or remove a durable subscription?

9.37.1 Steps

1

Using an account with an assigned Security scope of command role, choose Administration→Security→NFM-P User Security from the NFM-P main menu. The NFM-P User Security - Security Management (Edit) form opens.

2

Click on the Messaging Connections tab.

3 _____
Specify a filter and click Search. A list of active XML API client connections opens.

4 _____
Select a connection in the list and perform one of the following:

- a. Click Close Connection to shut down the client connection.
- b. Click Remove Connection to shut down the client connection and remove the durable subscription.

5 _____
Click Yes. The action is performed.

If you choose Close Connection, the connection is terminated, but the NFM-P continues to store JMS messages for the session.

If you choose Remove Connection, the NFM-P stops storing the JMS messages for the session.

 **Note:** When you remove a durable subscription, the XML API client can still attempt to connect to the XML API. You can prevent an XML API client from attempting to connect by suspending the XML API user account. See [9.29 “How do I suspend or reinstate an NFM-P user account?” \(p. 199\)](#) for more information.

6 _____
Close the form.

END OF STEPS _____

9.38 How do I view the user activity log?

9.38.1 Purpose

You can view user activity log entries associated with the following:

- a user
- a client session

 **Note:** Viewing user activity records other than LI activity records requires a user account with an assigned Administrator or NFM-P Management and Operations scope of command role.

 **Note:** Viewing LI user activity records requires a user account with an assigned Lawful Interception Management scope of command role. The scope is restricted to the records of users in the same LI user group.

9.38.2 Steps

1

Choose Administration→Security→User Activity from the NFM-P main menu. The NFM-P User Activity form opens.

2

Perform one of the following:

a. View the activities performed during a specific client session:

1. Configure the filter criteria, if required, and click Search. A list of session entries is displayed.

Note: Only client session entries with a State value of Connected contain activity entries.

2. Select the required session entry and click Properties. The Session form opens.

3. Click on the Activity tab.

4. Configure the filter criteria, if required, and click Search. A list of activity entries is displayed.

b. View the activities of a specific user.

1. Click on the Activity tab.

2. Specify the required username as the Username filter criterion and click Search. A list of user-specific entries is displayed.

3

Select an entry in the list and click Properties. The Activity form opens.

4

Review the general information, which matches the columnar information on the User Activity list form.

5

Depending on the activity Type and Sub Type, the Additional Info panel contains detailed activity information. If required, expand the panel to review the information. The following information is listed:

- **Type Operation, all Sub Types:**

- left pane—object hierarchy in tree form; each object is selectable

- right pane—properties and values of selected object in left pane

The Actions property, which is highlighted in yellow for an object creation or modification activity, has values that represent the actions associated with the activity, such as create and modify.

- **Type Deployment or Save, Sub Type Modification:**

- Property Name column—list of modified parameters

- New Value column—the parameter value set during the activity

- Old Value column—the previous parameter value

How do I view the user activity associated with an object?

6

If required, expand the XML panel to display more information about the activity. The panel displays the following information:

- Full Class Name—the NFM-P class descriptor of the affected object type
- Additional Info—the activity details in the form of an XML request

i **Note:** The displayed Additional Info text is limited to 4000 characters. If an activity generates more than 4000 characters of XML text, for example, access interface creation, the Additional Info panel of the log entry contains a “truncated” object, and the XML text contains a closing <truncated/> tag.

7

To navigate directly to the object of the activity, click View Object. The object properties form opens.

i **Note:** The View Object button is dimmed when there is no object associated with the activity, for example, a user login or logout operation.

8

View the activity information and close the form.

END OF STEPS

9.39 How do I view the user activity associated with an object?

9.39.1 Steps

i **Note:** Viewing user activity records other than LI activity records requires a user account with an assigned Administrator or NFM-P Management and Operations scope of command role. Viewing LI user activity records requires a user account with an assigned Lawful Interception Management scope of command role. The scope is restricted to the records of users in the same LI user group.

1

Open the required object properties form.

2

Click User Activity. The Activity form opens.

i **Note:** The User Activity function is available only for objects that exist in the NFM-P database. For example, the function is not available on the User Preferences form, because the settings on the form are saved in the client or client delegate file system.

3

Review the activity entries as described in [9.38 “How do I view the user activity log?”](#) (p. 206) and close the form.

END OF STEPS

9.40 How do I change the maximum number of concurrent NFM-P admin operator positions?



CAUTION

Service Disruption

Modifying the server configuration can have serious consequences including service disruption.

Contact technical support before you attempt to modify the server configuration.



Note: You must perform the procedure on each main server in the NFM-P system.



Note: In a redundant system, you must perform the procedure on the standby main server station first.

9.40.1 Steps

1

Log in to the main server station as the nsp user.

2

Open a console window.

3

Navigate to the `/opt/nsp/nfmp/server/nms/config` directory.

4

Create a backup copy of the `nms-server.xml` file.

5

Open the `nms-server.xml` file using a plain-text editor such as `vi`.

6

Locate the section that begins with following XML tag:

```
<samsession
```

How do I configure the number of allowed client sessions for a client delegate server?

7

Edit the following line in the section:

```
max5620SAMAdminSessions="value"
```

where *value* is the maximum number of concurrent admin operator positions

8

Save and close the nms-server.xml file.

9

On a standalone main server, or the primary main server in a redundant system, enter the following:

```
bash$ /opt/nsp/nfmp/server/nms/bin/nmsserver.bash read_config ↵
```

The NFM-P puts the configuration change into effect.

10

Close the open console windows.

END OF STEPS

9.41 How do I configure the number of allowed client sessions for a client delegate server?

9.41.1 Steps

The NFM-P continues to accept new client sessions from a client delegate server after the allowed number of sessions is reached. The maximum number of sessions is used as a guide for balancing the client session load among multiple client delegate servers.

1

Using an account with Update permission on the Server package, choose Administration→System Information from the NFM-P main menu. The System Information form opens.

2

Click on the Client Delegate Servers tab.

3

Select a client delegate server and click Properties. The Client Delegate Server (Edit) form opens.

4

Configure the Maximum UI Sessions parameter.

5

Save your changes and close the form.

END OF STEPS

9.42 How do I enable secure access for remote LDAP users?



CAUTION

Service Disruption

Performing the procedure requires a restart of each main server in the NFM-P system, which is service-affecting.

You must perform the procedure only during a scheduled maintenance period.



Note: In a redundant system, you must perform the procedure on the standby main server station first.



Note: The remote LDAP server must be operational and accessible to the NFM-P when you perform the procedure.



Note: Because of a Java update that enables endpoint identification on each LDAPS connection, an NFM-P system may no longer be able to connect to a secured LDAP server after you upgrade the NFM-P system. In such a case, you must populate the SAN field in the LDAP server TLS certificate with the LDAP server IP address, as required by the CA. If you need to disable NFM-P endpoint verification, contact technical support for assistance.

9.42.1 Steps

1

Log in as the nsp user on the main server station.

2

Open a console window.

3

Navigate to the `/opt/nsp/nfmp/server/nms/bin` directory.

4

Enter the following to import the LDAP server TLS certificate to the NFM-P keystore:

```
bash$ ./nmserver.bash add_to_keystore IP_address port ↵
```

where

IP_address is the LDAP server IP address

port is the LDAP server port

The script prompts you for the keystore alias.

5

Press ↵ to accept the default.

The script prompts you for the keystore password.

6

Enter the keystore password.

The certificate is imported to the keystore.

7

Restart the main server.

i **Note:** When you restart the primary main server in a redundant system, a server activity switch occurs, and the standby main server assumes the primary role.

1. Enter the following:

```
bash$ ./nmserver.bash force_restart ↵
```

The main server restarts.

2. If you are restarting the standby main server in a redundant system, enter the following to display the server status:

```
bash$ ./nmserver.bash appserver_status ↵
```

The server status is displayed; the server is fully initialized if the status is the following:

```
Application Server process is running. See nms_status for more detail.
```

If the server is not fully initialized, wait five minutes and then repeat this step. Do not perform the next step until the server is fully initialized.

8

Close the console window.

END OF STEPS

9.43 How do I enable remote user authorization via RADIUS?



CAUTION

Service Disruption

Performing the procedure requires a restart of each main server in the NFM-P system, which is service-affecting.

You must perform the procedure only during a scheduled maintenance period.

9.43.1 Steps

Enable NFM-P remote RADIUS authorization

1 _____

Perform [Step 3](#) to [Step 10](#) on each NFM-P main server station.



Note: In a redundant system, you must perform the steps on the standby main server station first.

2 _____

Go to [Step 11](#).

3 _____

Log in to the main server station as the nsp user.

4 _____

Open a console window.

5 _____

Navigate to the `/opt/nsp/nfmp/server/nms/config` directory.

6 _____

Open the `SamJaasLogin.config` file using a plain-text editor such as `vi`.

7 _____

Locate the `RADIUSLogin` section of the file and set the `samvsa` parameter to `true`, as shown in [Code Figure 9-2, "SamJaasLogin.config file, RADIUS parameters" \(p. 212\)](#) :

Figure 9-2 SamJaasLogin.config file, RADIUS parameters

```
RADIUSLogin
{
  com.timetra.nms.server.jaas.provider.radius.auth.RadiusJaasLoginModule
  REQUIRED
      debug=false
      samvsa=true
      ;
};
```

8 _____

Save and close the file.

9

Restart the main server.

i **Note:** When you restart the primary main server in a redundant system, a server activity switch occurs, and the standby main server assumes the primary role.

1. Enter the following:

```
bash$ ./nmserver.bash force_restart ↵
```

The main server restarts.

2. If you are restarting the standby main server in a redundant system, enter the following to display the server status:

```
bash$ ./nmserver.bash appserver_status ↵
```

The server status is displayed; the server is fully initialized if the status is the following:

```
Application Server process is running. See nms_status for more detail.
```

If the server is not fully initialized, wait five minutes and then repeat this step. Do not perform the next step until the server is fully initialized.

10

Close the console window.

Configure remote RADIUS server

11

Copy the RADIUS dictionary section in Code [Figure 9-3, "NFM-P RADIUS dictionary entry" \(p. 214\)](#) to the RADIUS dictionary file on the RADIUS server.

i **Note:** The vendor ID must be 123.

Figure 9-3 NFM-P RADIUS dictionary entry

```
VENDOR          Nokia          123
BEGIN-VENDOR
ATTRIBUTE       Sam-security-group-name 3      group_name
END-VENDOR
```

12

Change *group_name* in the entry to the name of a valid NFM-P user group.

13

As the RADIUS server administrator, add the NFM-P_security_group VSA to the RADIUS user profile, as shown in the following:

```
Sam-security-group-name="user_group"
```

where *user_group* is the name of a valid NFM-P user group

END OF STEPS

9.44 How do I enable remote user authorization via TACACS+?



CAUTION

Service Disruption

Performing the procedure requires a restart of each main server in the NFM-P system, which is service-affecting.

You must perform the procedure only during a scheduled maintenance period.

9.44.1 Steps

Enable NFM-P remote TACACS+ authorization

1

Perform [Step 3](#) to [Step 10](#) on each NFM-P main server station.



Note: In a redundant system, you must perform the steps on the standby main server station first.

2

Go to [Step 11](#).

3

Log in to the main server station as the nsp user.

4

Open a console window.

5

Navigate to the `/opt/nsp/nfmp/server/nms/config` directory.

6

Open the `SamJaasLogin.config` file using a plain-text editor such as `vi`.

7

Locate the `TACACSLogin` section of the file and set the `samvsa` parameter to `true`, as shown in Code [Figure 9-4, "SamJaasLogin.config file, TACACS+ parameters"](#) (p. 216) :

Figure 9-4 SamJaasLogin.config file, TACACS+ parameters

```
TACACSLogin
{
    com.timetra.nms.server.jaas.provider.tacacs.auth.TacacsPlus-
JaasLoginModule REQUIRED
    debug=false
    samvsa=true
    ;
};
```

8

Save and close the file.

9

Restart the main server.



Note: When you restart the primary main server in a redundant system, a server activity switch occurs, and the standby main server assumes the primary role.

1. Enter the following:

```
bash$ ./nmserver.bash force_restart ↵
```

The main server restarts.

2. If you are restarting the standby main server in a redundant system, enter the following to display the server status:

```
bash$ ./nmserver.bash appserver_status ↵
```

The server status is displayed; the server is fully initialized if the status is the following:

```
Application Server process is running. See nms_status for more
detail.
```

If the server is not fully initialized, wait five minutes and then repeat this step. Do not perform the next step until the server is fully initialized.

10

Close the console window.

Configure remote TACACS+ server

11

As the TACACS+ server administrator, add the user group VSA to the TACACS+ user profile, as shown in the following:

```
service=sam-app{
sam-security-group="user_group"
}
```

where *user_group* is the name of a valid NFM-P user group

END OF STEPS

9.45 How do I configure NFM-P remote user authentication?

9.45.1 Steps

Assign default external user group

1

Using an account with an assigned Security scope of command role, choose Administration→Security→NFM-P User Security from the NFM-P main menu. The NFM-P User Security - Security Management (Edit) form opens.

2

Select a user group in the Default External User Group panel.



Note: Do not select a user group that has the Apply Local Authentication Only parameter enabled, or remote login attempts fail.

3

Save your changes and close the form.

Configure remote servers

4

Using an account with an assigned Security scope of command role, choose Administration→Security→NFM-P Remote User Authentication from the NFM-P main menu. The Remote Authentication Manager (Edit) form opens.

5

Configure the parameters.

6

Configure one or more RADIUS authentication servers, as required.

1. Click on the RADIUS tab and click Create. The SAM RADIUS Authentication Server (Create) form opens.
2. Configure the required parameters.
3. Save your changes.

7

Configure one or more TACACS+ authentication servers, as required.

1. Click on the TACACS tab and click Create. The SAM TACACS+ Authentication Server (Create) form opens.
2. Configure the required parameters.
3. Save your changes.

8

Configure one or more LDAP authentication servers, as required.

1. Click on the LDAP tab and click Create. The LDAP Authentication Server (Create) form opens.
2. Configure the general parameters.

Note: The ID value that you specify defines the server priority. For example, if multiple servers are specified, the NFM-P attempts user authentication using the server that has the lowest ID value first. If the server is unavailable, the NFM-P attempts to connect to the other specified servers, in sequence, by ID.

3. Configure the parameters in the Lookup Credentials panel, if the LDAP server does not allow anonymous lookups.

The Bind DN parameter specifies the LDAP attribute set that identifies a user who is authorized to perform LDAP lookups; the Bind DN password is the password of the user.

4. Configure the parameters in the User Lookup Settings panel.

The Base DN parameter specifies the LDAP context for username and password lookup; for example, `ou=People,dc=MyCompany,dc=org`.

The Base Filter parameter specifies a filter for the username query. The parameter format is the following:

`(attribute={USERNAME})`

where

attribute is the LDAP attribute that contains the username

The NFM-P replaces `{USERNAME}` with the username provided during a login attempt; for example, `(cn={USERNAME})` maps the “cn” LDAP attribute to the username.

5. If the LDAP server has user role information and is to provide the name of a user group, configure the parameters in the Group Lookup Settings panel.

Note: The user group name that an LDAP server provides must match the name of a valid NFM-P user group; otherwise, an authenticated user is assigned to the default external user group.

The Group DN parameter specifies the LDAP context for group lookup; for example:

`ou=Roles,dc=MyCompany,dc=org`

The Group Filter parameter format is one of the following:

- **simple; the NFM-P replaces {1} with the DN of the user LDAP record**

`(attribute={1})`

where *attribute* is the LDAP attribute that contains the DN

- **compound; the NFM-P replaces {USERNAME} with the username provided during a login attempt**

```
(&(any_attribute=string)(user_attribute={USERNAME}))
```

where

any_attribute is an LDAP attribute

string is the attribute value to match

user_attribute is the LDAP attribute that contains the username

The Attribute ID parameter specifies one of the following:

- the LDAP attribute name that maps to an NFM-P group name
- the DN of the query context, if the Attribute is DN? parameter is selected; the “name” attribute in the record maps to an NFM-P group name

6. Save your changes.

9

Close the Remote Authentication Manager (Edit) form.

END OF STEPS

9.46 How do I change the NFM-P Task Manager settings?

 **Note:** The Task Manager is operational with the default values.

9.46.1 Steps

1

Log in to the primary or standalone main server station as the nsp user.

2

Open a console window.

3

Navigate to the `/opt/nsp/nfmp/server/nms/config` directory.

4



CAUTION

Service Disruption

Contact technical support before you attempt to modify the `nms-server.xml` file.

Modifying the `nms-server.xml` file can have serious consequences that can include service disruption.

Open the `nms-server.xml` file using a plain-text editor such as vi.

5

Find and configure the required parameters:

- maxNumRetainedTasks
- numTasksToPurgeWhenFull
- successfulTasksPurgeInterval
- failedTasksPurgeInterval

6

Save and close the nms-server.xml file.

7

Navigate to the /opt/nsp/nfmp/server/nms/bin directory.

8

Enter the following to restart the main server:

```
bash$ ./nmserver.bash force_restart ↵
```

The main server restarts, and the configuration change takes effect.

9

Modify the client configuration, if required.

1. Log in to an NFM-P single-user client or client delegate server station.

Note: If you log in to a RHEL client delegate server station, you must log in as the nsp user.

Note: If you log in to a single-user client station, you must log in as the user who installed the client, or as a local administrator.

2. Open a console window.
3. Navigate to the client configuration directory, typically /opt/nsp/client/nms/config on RHEL, and C:\nsp\client\nms\config on Windows.
4. Open the nms-client.xml file using a text editor.
5. Configure the autoRefreshInterval parameter.
6. Save and close the nms-client.xml file.
7. Repeat [Step 7](#) and [Step 8](#) to restart the main server.

10

Close the console windows and form. See the *NSP NFM-P User Guide* for information about using the NFM-P Task Manager.

END OF STEPS

9.47 How do I export all workspaces and local tab preferences?

9.47.1 Steps

- 1 _____
Choose Administration→Security→NFM-P User Security from the NFM-P main menu. The NFM-P User Security - Security Management (Edit) form opens.
- 2 _____
Click Settings and choose Export All. The Export Directory window opens.
- 3 _____
Specify the export directory, or create a directory or folder, and click Save. All the workspaces and local tab preferences are exported to the specified directory. If the directory exists, a dialog box appears.
- 4 _____
Click Yes to overwrite all the workspaces and local tab preferences saved in the existing directory.
- 5 _____
Close the form.

END OF STEPS _____

9.48 How do I import workspaces and local tab preferences?

9.48.1 Steps

- 1 _____
Choose Administration→Security→NFM-P User Security from the NFM-P main menu. The NFM-P User Security - Security Management (Edit) form opens.
- 2 _____
Click Settings and choose Import. The Import Directory window opens.
- 3 _____
Click on the drop-down menu and choose one of the following:
 - a. Import All (default)—to import all the workspaces and local tab preferences.
If you choose this option, you can click on the Overwrite Existing Workspace(s) check box to allow overwriting of existing workspaces.
 - b. Import Workspaces Only—to import only workspaces from the specified directory.

How do I import workspaces and local tab preferences?

If you choose this option, you can click on the Overwrite Existing Workspace(s) check box to allow overwriting of existing workspaces.

c. Import Tabs Only—to import only local tab preferences from the specified directory.

4

Click Open. A confirmation dialog box displays the number of workspaces and local tab preferences that will be imported from the specified directory.

5

Click Yes.

All users whose local tab preferences change and currently have a client session open, other than the client session where the import has been initiated, receive a message to inform them of the local tab preference change and that they must restart the client, or risk losing the changes.

The user can use the Reply function to reply to the message.

For all users who have their current workspace changed and currently have a client session opened, the workspace selector displays Workspace Out of Sync. Select the current workspace from the workspace selector drop-down menu to apply the modified settings.

6

Close the form.

END OF STEPS

10 Classic management NE security

10.1 What is NFM-P NE security?

10.1.1 Access management



CAUTION

Service Disruption

The NFM-P cannot obtain a secret value from an NE during resynchronization. It is recommended that you use only the NFM-P to configure a shared authentication secret.

Do not configure a shared authentication secret directly on a managed NE using another interface, for example, a CLI, or the NFM-P cannot synchronize the security policy with the NE.

You can use the NFM-P to configure security for managed-device access that includes the following:

- device user accounts, profiles, and passwords
- RADIUS, TACACS+, and LDAP authentication for NFM-P user accounts
- MAFs
- CPM filters
- DoS protection
- DDoS protection
- X.509 authentication
- TCP enhanced authentication

10.1.2 General rules

An NFM-P site user profile specifies which CLI commands or command groups are permitted or denied on a managed device. A profile can be associated with multiple NFM-P user accounts, and each user account can have up to eight associated profiles.

The following general rules apply to NFM-P security management for devices.

- The authentication settings on a device override any settings distributed by the NFM-P. For example, if you use the NFM-P to configure a user account with SHA authentication, and then distribute the account to a device that uses MD5 authentication, the account authentication type changes to MD5.
- MAFs and CPM filters must be manually distributed to a managed device.
- An operator can limit the type of managed device access per user, for example, allowing FTP access, but denying console, Telnet, and SNMP access.
- A user profile is independent of a user account, and is not in effect until associated with a user account.

10.2 What are RADIUS, TACACS+, and LDAP?

10.2.1 Overview

RADIUS is an access server AAA protocol. The protocol provides a standardized method of exchanging information between a RADIUS client, which is located on a device and managed by the NFM-P, and a RADIUS server, which is located externally from the device and the NFM-P.

RADIUS provides an extra layer of login security. The RADIUS client relays user account information to the RADIUS server, which authenticates the user and returns user privilege information. The information defines the device access of the user. For example, a user may not be allowed to FTP information to or from the device.

You can create device user accounts as a backup to RADIUS, TACACS+, or LDAP authentication. In the event that a RADIUS, TACACS+, or LDAP function fails, the device user account provides device access.

TACACS+ and LDAP provide functions that are similar to RADIUS functions.

i **Note:** The NFM-P checks for reachability to a TACACS+ server using UDP port 49 to prevent long timeout issues. However, all subsequent communication with the server uses TCP port 49.

See the appropriate RADIUS, TACACS+, or LDAP documentation for information about authentication server installation, configuration, and management.

For TACACS+ users, you can specify the following in a user template that is read by the global TACACS+ policy:

- the type of permitted device access, for example, console, FTP, or both
- a home directory
- a login script to execute

10.2.2 Combined local and remote authentication

An organization may have an established TACACS+ or RADIUS authentication configuration. You can add NFM-P client GUI user accounts to an existing TACACS+ or RADIUS user base for local NFM-P authentication.

Consider the following:

- You can create an NFM-P user account that matches a TACACS+, RADIUS, or LDAP user account. For example, if the RADIUS user account is Jane, you can create an NFM-P user Jane.
- Remote users with usernames that don't abide by the following rules may not work correctly. An NFM-P user name must begin with an alphanumeric character, and can:
 - be from 1 to 40 characters in length
 - include the following special characters: . - _ @
 - not include a space character
- An NFM-P user that is authenticated remotely can log in to the NFM-P using the RADIUS, TACACS+, or LDAP password.
- For local NFM-P user authentication, the account password must meet the NFM-P password requirements.

For example, for a user called Jane:

- The RADIUS user name is Jane, and the password is accessforjane.
- The NFM-P user name is Jane and password is !LetJane1In.

When Jane is authenticated by RADIUS, she can log in to the NFM-P client by typing in Jane and accessforjane. If the RADIUS server was down, and she could not be authenticated remotely, to be authenticated locally Jane must log in to the NFM-P client by typing jane and !LetJane1In.

10.3 What is device SSH security?

10.3.1 NSP SSH algorithm support for mediation

The following SSH client cryptographic algorithms are deprecated by the NSP and disabled by default for classic management and model-driven mediation in the NSP:

- Cipher: arcfour256,arcfour128,3des-cbc,blowfish-cbc
- Key Exchange: diffie-hellman-group-exchange-sha1, diffie-hellman-group14-sha1,diffie-hellman-group1-sha1 (classic management mediation only)
- MAC: hmac-md5,hmac-sha1-96,hmac-md5-96
- Host Key: ssh-dss

For compatibility with older devices, you can restore NFM-P support for the disabled algorithms, as described in [10.4 “How do I restore support for disabled NE SSH algorithms?”](#) (p. 224).

 **Note:** Restoring the disabled algorithms is not recommended, but may be required as an interim measure until the devices in your network support the newer SSH algorithms.

10.4 How do I restore support for disabled NE SSH algorithms?



CAUTION

Service Disruption

Modifying the server configuration can have serious consequences that include service disruption. Contact technical support before you attempt to modify the server configuration.



CAUTION

Security Risk

Restoring support for older SSH algorithms lowers the level of security in your network.

You must perform the procedure only as an interim measure until the devices in your network support the newer SSH algorithms, or as directed by technical support.

 **Note:** You must perform the procedure on each main server in the NFM-P system.

i **Note:** In a redundant system, you must perform the procedure on the standby main server station first.

10.4.1 Steps

1 _____
Log in to the main server station as the nsp user.

2 _____
Open a console window.

3 _____
Navigate to the `/opt/nsp/nfmp/server/nms/config` directory.

4 _____
Create a backup copy of the `nms-server.xml` file, and store the file in a secure location on a station outside the management network.

5 _____
Open the `nms-server.xml` file using a plain-text editor such as `vi`.

6 _____
Locate the section that begins and ends with following XML comment tags:

```
<!--<sshSecurity
    -->
```

7 _____
Locate the section that immediately follows; the section begins and ends with following XML tags:

```
<sshSecurity
    />
```

8 _____
Replace the two sections with the following:

i **Note:** The content below may include line breaks inserted during the publishing of this guide. You must join the broken lines by removing any line breaks between quotation marks.

```
<!-- <sshSecurity
bypassIgnoreSshKeyMismatch="false"
cipherAlgorithms="chacha20-poly1305@openssh.com,aes128-ctr,aes192-ctr,
aes256-ctr,aes128-gcm@openssh.com,aes256-gcm@openssh.com,aes128-cbc,
```

```
aes192-cbc, aes256-cbc, arcfour256, arcfour128, 3des-cbc, blowfish-cbc"
kexAlgorithms="curve25519-sha256, curve25519-sha256@libssh.org,
curve448-sha512, ecdh-sha2-nistp521, ecdh-sha2-nistp384, ecdh-sha2-
nistp256, diffie-hellman-group-exchange-sha256, diffie-hellman-group18-
sha512, diffie-hellman-group17-sha512, diffie-hellman-group16-sha512,
diffie-hellman-group15-sha512, diffie-hellman-group14-sha256, diffie-
hellman-group-exchange-sha1, diffie-hellman-group14-sha1, diffie-
hellman-group1-sha1"
macAlgorithms="hmac-sha2-256-etm@openssh.com, hmac-sha2-512-
etm@openssh.com, hmac-sha1-etm@openssh.com, hmac-sha2-256, hmac-sha2-512,
hmac-sha1, hmac-md5, hmac-sha1-96, hmac-md5-96"
signatureAlgorithms="ecdsa-sha2-nistp256-cert-v01@openssh.com, ecdsa-
sha2-nistp384-cert-v01@openssh.com, ecdsa-sha2-nistp521-cert-
v01@openssh.com, ssh-ed25519-cert-v01@openssh.com, rsa-sha2-512-cert-
v01@openssh.com, rsa-sha2-256-cert-v01@openssh.com, ecdsa-sha2-nistp256,
ecdsa-sha2-nistp384, ecdsa-sha2-nistp521, ss-ed25519, sk-ecdsa-sha2-
nistp256@openssh.com, sk-ssh-ed25519@openssh.com, rsa-sha2-512, rsa-sha2-
256, ssh-rsa, ssh-dss"
/>
-->
<sshSecurity
bypassIgnoreSshKeyMismatch="false"
cipherAlgorithms="chacha20-poly1305@openssh.com, aes128-ctr, aes192-ctr,
aes256-ctr, aes128-gcm@openssh.com, aes256-gcm@openssh.com, aes128-cbc,
aes192-cbc, aes256-cbc, arcfour256, arcfour128, 3des-cbc, blowfish-cbc"
kexAlgorithms="curve25519-sha256, curve25519-sha256@libssh.org,
curve448-sha512, ecdh-sha2-nistp521, ecdh-sha2-nistp384, ecdh-sha2-
nistp256, diffie-hellman-group-exchange-sha256, diffie-hellman-group18-
sha512, diffie-hellman-group17-sha512, diffie-hellman-group16-sha512,
diffie-hellman-group15-sha512, diffie-hellman-group14-sha256, diffie-
hellman-group-exchange-sha1, diffie-hellman-group14-sha1, diffie-
hellman-group1-sha1"
macAlgorithms="hmac-sha2-256-etm@openssh.com, hmac-sha2-512-
etm@openssh.com, hmac-sha1-etm@openssh.com, hmac-sha2-256, hmac-sha2-512,
hmac-sha1, hmac-md5, hmac-sha1-96, hmac-md5-96"
signatureAlgorithms="ecdsa-sha2-nistp256-cert-v01@openssh.com, ecdsa-
sha2-nistp384-cert-v01@openssh.com, ecdsa-sha2-nistp521-cert-
v01@openssh.com, ssh-ed25519-cert-v01@openssh.com, rsa-sha2-512-cert-
v01@openssh.com, rsa-sha2-256-cert-v01@openssh.com, ecdsa-sha2-nistp256,
ecdsa-sha2-nistp384, ecdsa-sha2-nistp521, ss-ed25519, sk-ecdsa-sha2-
nistp256@openssh.com, sk-ssh-ed25519@openssh.com, rsa-sha2-512, rsa-sha2-
256, ssh-rsa, ssh-dss"
/>
```

9

Save and close the nms-server.xml file.

10

Enter the following to restart the main server:

i **Note:** When you restart the primary main server in a redundant system, a server activity switch begins, and the standby main server restarts as the primary main server. If you want to restore the initial primary and standby roles, you must perform this step on the standby main server once again after the server initializes as the primary.

```
bash$ /opt/nsp/nfmp/server/nms/bin/nmserver.bash force_restart ↵
```

11

Close the open console windows.

END OF STEPS

10.5 What are CPM filters and traffic management?

10.5.1 Overview

Device CPMs provide dedicated traffic management and queuing hardware to protect the control plane. You can use CPM filters to specify which types of traffic to accept or deny, and to allocate and rate-limit the shaping queues for traffic directed to the CPMs.

i **Note:** The 7705 SAR does not support Queue filters or MAC CPM IP filters. There is no partial distribution of CPM IP filter policies to a 7705 SAR. When you distribute a CPM IP Filter policy to a 7705 SAR, every entry, property, and value in the policy must be supported by the NE, or the policy distribution to the 7705 SAR is blocked.

10.5.2 Supported management functions

The NFM-P supports the following CPM traffic management functions:

- traffic classification using CPM filters
 - Packets going to the CPM are first classified by the IOM into forwarding classes before recognition by the CPM hardware. You can use CPM filters to further classify the packets using L3/L4 information, for example, destination IP, DSCP value, and TCP SYN/ACK.
- queue allocation
 - Queues 1 — 8 are the default queues, which cannot be modified or deleted; unclassified traffic is directed to the default queues.
 - Queues 9 — 32 are reserved for future use.
 - Queues 33 — 2000 are available for allocation.
 - Queues 2001 — 8000 are used for per-peer queuing.
- queue configuration
 - PIR
 - CIR
 - CBS
 - MBS

10.6 What is DoS protection?

10.6.1 Overview

The NFM-P supports the use of DoS protection on network and access interfaces. To protect NEs from the high incoming packet rates that characterize DoS attacks, you can use the NFM-P to configure DoS protection for the following scenarios:

- the arrival of unprovisioned link-layer protocol packets that are received from CE devices in the core network
- the arrival of excessive subscriber control-plane packets on L2 or L3 access interfaces in aggregation networks
- the arrival of excessive Ethernet CFM frames on L2 and L3 access interfaces, SAPs, and SDP bindings, based on a combination of CFM OpCode and MEG-level values

DoS protection limits the number of packets that are received each second, and optionally logs a violation notification if a policy limit is exceeded. You can use the NE System Security form to view the violations for a specific NE.

10.6.2 DoS protection in the core network

DoS protection in the core network limits the number of link-layer protocol packets that each network interface on an NE accepts for protocols that are not enabled on the interface. The interface drops the excessive packets instead of queueing the packets for processing by the CPU.

You can configure global DoS protection on an NE using the NE System Security form. DoS protection controls the following for unprovisioned link-layer protocols:

- the packet arrival rate per source on each network interface
- the overall packet arrival rate per source on the NE
- whether an NE sends a notification trap if a policy limit is exceeded

An NE that supports DoS protection automatically applies default DoS protection parameters to each network and access interface. These defaults limit only the overall packet arrival rate and apply to all of the interfaces on the NE.

10.6.3 DoS protection policies in aggregation networks

In a subscriber aggregation network, an NE typically receives few control-plane packets from a specific subscriber. If one or more subscribers generate excessive control-plane traffic, DoS protection policies can help to ensure that NEs do not become overburdened by these unwanted packets.

You can configure DoS protection policies to control the following on network interfaces, VPLS L2 access interfaces, and IES and VPRN L3 access interfaces:

- the control-plane packet arrival rate per subscriber host
- the overall control-plane packet arrival rate for the interface
- whether an NE sends a notification trap if a policy limit is exceeded

An NE that supports DoS protection automatically assigns a default DoS protection policy to each network and access interface. This default policy limits only the overall packet arrival rate for the interface, and cannot be deleted or modified.

See [10.13 “How do I configure an NE DoS protection policy?” \(p. 239\)](#) for information about creating or modifying a DoS protection policy and assigning the policy to one or more NEs, and the *NSP NFM-P User Guide* for information about applying a policy to service interfaces.

10.7 What is DDoS protection?

10.7.1 Overview

DDoS protection extends DoS protection by controlling traffic destined for IOM or CPM CPUs on a per-SAP, per-protocol basis. A DDoS protection policy isolates protocols from each other and, at the same time, isolates subscribers so that attacks or misconfigurations affect only the source SAP or protocol.

Policers are used to enforce a traffic rate-limiting function. Rate limiting is configurable in packets per second or kb/s. Configurable burst tolerance allows extra full handshake attempts, as required by some protocols.

When a policer determines that a packet is non-conformant, it discards the packet or marks it as low-priority. Low-priority traffic is more likely to be discarded at a downstream queueing point if there is protocol congestion. Traffic marking is also useful for routing protocols, where an operator may need to offer all packets to the CPU, and only discard packets if the CPU cannot keep up. A policer can be mapped to one or more traffic protocols.

The following types of policer can be configured in a DDoS protection policy:

- static policers, which permanently instantiate enforcement policers on SAPs
- local monitoring policers, which dynamically instantiate enforcement policers on SAPs

A DDoS protection policy can be applied to a capture SAP or to an MSAP. A DDoS protection policy that is assigned to a capture SAP typically has higher traffic rate limiting values than a policy that is assigned to an MSAP.

There are two types of DDoS protection policies:

- Access-interface type
- Port type

A default port-type policy does not initially reside in the NFM-P, but is collected from a supporting NE during discovery synchronization. The port-type policy applies only for select port-based protocols, and is applied automatically to all ports when the policy is distributed to an NE that supports the port-type policy.

An access-interface type DDoS protection policy can be applied to the following objects:

- base router network interface other than a system or loopback interface
- VPRN network interface a loopback interface
- VPRN L3 access interface
- VPRN group interface SAP

- IES L3 access interface
- IES group interface SAP
- VPLS L2 access interface
- I-VPLS I-L2 access interface
- MVPLS L2 access interface
- I-MVPLS I-L2 access interface
- VLL E-Pipe L2 access interface
- VLL I-Pipe L2 access interface

See 10.15 “How do I configure an NE DDoS protection policy?” (p. 241) for information about creating or modifying an NE DDoS protection policy and assigning the policy to one or more NEs.

10.7.2 DDoS alarm handling

To prevent raising multiple DDoS alarms against one affected object, the NFM-P raises one DDoS alarm per object, and updates the alarm as the object generates new DDoS events.

An operator can view dynamically updated alarm information, and avoid the generation of excessive numbers of individual DDoS alarm messages. Figure 10-1, “Static policer alarm message sequence” (p. 230) shows the alarm message sequence for a static policer. Figure 10-2, “Local monitoring policer alarm message sequence” (p. 232) shows the alarm message sequence for local monitoring policer. Figure 10-3, “Dynamic policer alarm message sequence” (p. 232) shows the alarm sequence for a dynamic policer. In each sequence, the alarm clears when the policer returns to the Conform state.

Figure 10-1 Static policer alarm message sequence

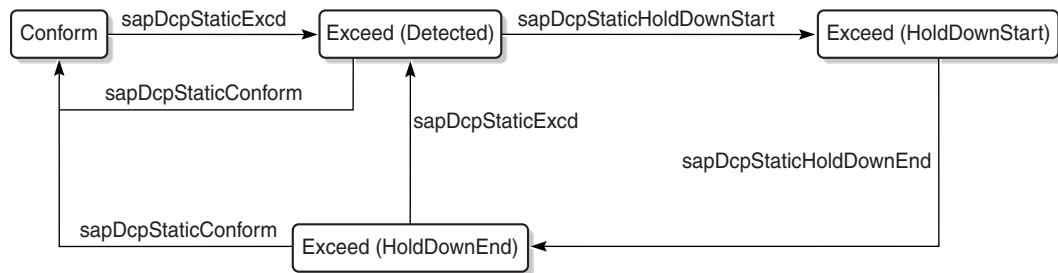

23498

Figure 10-2 Local monitoring policer alarm message sequence

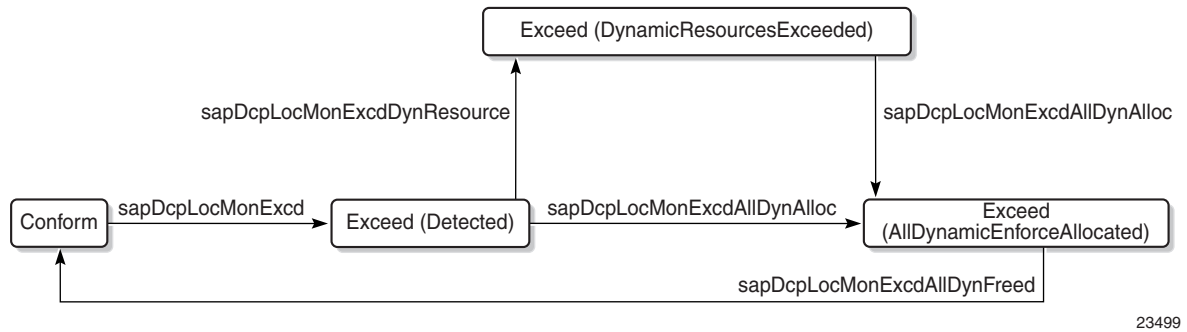

23499

Figure 10-3 Dynamic policer alarm message sequence

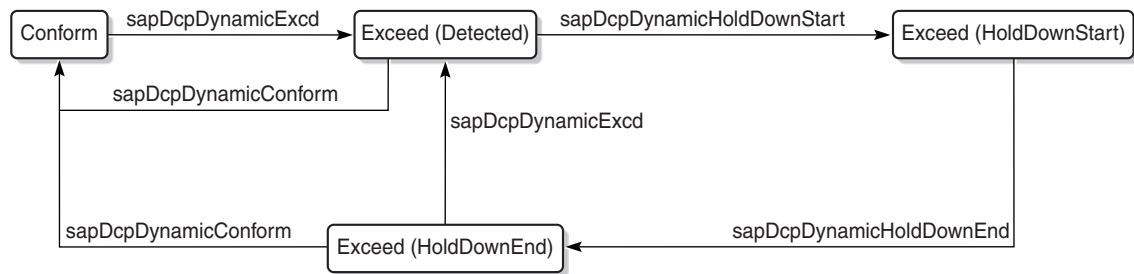

23528

10.8 What is IP security?

10.8.1 Overview

The NFM-P supports the IPsec MDA, which provides IP security support including tunneling and encryption functions. See the device security documentation for more information about configuring IP security.

10.9 HSM

10.9.1 Overview

The NFM-P supports the 1830 SMS netHSM security-key management platform.

To enable the 1830 SMS netHSM functions in the NFM-P, you must create an HSM configuration file on an NSP host server, and then enable and configure HSM on each main server. See the system installation procedures for information.

10.10 Workflow: manage NE user and device security

10.10.1 Stages

- 1 _____
Specify the type of authentication keys used on the device; for example, SHA or MD5, as part of the device discovery. See “To commission a device for NFM-P management” in the *NSP NFM-P User Guide* for more information.
- 2 _____
Create a MAF for each device; see [10.11 “How do I configure a MAF?” \(p. 235\)](#) .
- 3 _____
Create filter policies for device CPM modules; see [10.12 “How do I configure a CPM filter?” \(p. 236\)](#) .
- 4 _____
Create NE DoS protection policies, as required to control the amount of subscriber-based control-plane traffic that the NE interfaces receive; see [10.13 “How do I configure an NE DoS protection policy?” \(p. 239\)](#) .
- 5 _____
View NE DoS protection violations, as required; see [10.14 “How do I view NE DoS protection violations?” \(p. 240\)](#) .
- 6 _____
Create NE DDoS protection policies, as required to isolate protocols from each other and isolate subscribers so that attacks or misconfigurations affect only the source SAP or protocol; see [10.15 “How do I configure an NE DDoS protection policy?” \(p. 241\)](#) .
- 7 _____
Configure NE TLS authentication for client NEs, as required; see [10.16 “How do I configure NE TLS client authentication?” \(p. 243\)](#).
- 8 _____
Configure NE TLS Authentication for servers, as required; see [10.17 “How do I configure NE TLS server authentication?” \(p. 245\)](#).
- 9 _____
Create site user profiles based on job classifications and the access needed to the managed devices; see [10.22 “How do I configure a site user profile?” \(p. 250\)](#) .
- 10 _____
Create individual site user accounts based on the configured profiles; see [10.23 “How do I](#)

[configure a user account on a managed device?" \(p. 267\)](#) .

11

Specify password policies for access to managed devices and users; see [10.24 "How do I configure an NE password policy?" \(p. 252\)](#) .

12

Create RADIUS, TACACS+, or LDAP access or security policies for user authentication on the managed device; see [10.25 "How do I configure an LDAP site authentication policy?" \(p. 253\)](#), [10.26 "How do I configure an NE RADIUS authentication policy?" \(p. 254\)](#), , [10.27 "How do I configure an NE TACACS+ authentication policy?" \(p. 255\)](#) , or [10.28 "How do I configure an OmniSwitch RADIUS, TACACS+, or LDAP security authentication policy?" \(p. 257\)](#) .

13

View or configure the system security settings on managed NEs; see [10.29 "How do I configure device system security settings?" \(p. 257\)](#) .

14

As required, configure X.509 authentication or a PKI certificate authority profile; see [10.30 "How do I configure and manage PKI site security on an NE?" \(p. 260\)](#) or [10.31 "How do I configure a PKI certificate authority profile?" \(p. 264\)](#) .

15

Configure a PKI Enrolment over Secure Transport profile; see [10.34 "How do I configure an Enrollment over Secure Transport profile?" \(p. 267\)](#).

16

Perform PKI CMPv2 actions, as required, to obtain or assign keys from a CA; see [10.37 "How do I perform CMPv2 actions?" \(p. 270\)](#) .

17

Perform the following NE system security tasks, as required:

- a. Delete security policies; see [10.38 "How do I delete a security policy?" \(p. 273\)](#) .
- b. Unlock user accounts that are locked due to failed login attempts; see [10.39 "How do I manually unlock a user account?" \(p. 274\)](#) .
- c. Clear the password history for a user on a managed object; see [10.40 "How do I clear the password history of a user on a managed device?" \(p. 275\)](#) .
- d. Perform CPMv2 certificate administration actions; see [10.37 "How do I perform CMPv2 actions?" \(p. 270\)](#) .
- e. Clear collected statistics information on a CPM filter; see [10.41 "How do I clear collected statistics on a CPM filter?" \(p. 275\)](#) .

-
- f. Clear OCSP cache entries on an NE; see [10.42 “How do I manage OCSP cache entries on an NE?”](#) (p. 277) .

10.11 How do I configure a MAF?

i **Note:** To perform this procedure, you require an account with an assigned Administrator scope of command role to the sitesec package, or a scope of command role with write access permission to the sitesec package.

10.11.1 Steps

- 1 _____
Choose Administration→Security→NE Management Access Filters from the NFM-P main menu. The NE Management Access Filter form opens.
- 2 _____
Click Create or choose a policy and click Properties. The Site Management Access Filter (Create|Edit) form opens.
- 3 _____
Configure the general parameters.
- 4 _____
Configure the required parameters in the IPv4, IPv6, and MAC panels.
- 5 _____



CAUTION

Service Disruption

When you set the Action parameter to deny, you cannot distribute the MAF to an NE.

You must set the parameter to permit, manually distribute the MAF as required, and then set the parameter to deny in each local MAF instance.

To configure an IPv4 or IPv6 entry, perform the following steps.

1. Click on the IPv4 Entries or IPv6 Entries tab.
 2. Click Create or choose an entry and click Properties. The Site MAF Match Entry (Create|Edit) form opens.
 3. Configure the required parameters.
 4. Save your changes and close the form.
- 6 _____
Repeat [Step 5](#) to configure an additional IPv4 or IPv6 entry, if required.

7

To configure a MAC entry, perform the following steps.

1. Click on the MAC Entries tab.
2. Click Create or choose an entry and click Properties. The Site MAC Match Entry (Create|Edit) form opens.
3. Configure the required parameters.
4. Click on the Filter Properties tab and configure the required parameters.

If you set the Frame Type parameter to e802dot2LLC, configure the parameters in the Match Criteria - DSAP SSAP panel.

If you set the Frame Type parameter to e802dot2SNAP, configure the parameters in the Match Criteria - SNAP panel.

If you set the Frame Type parameter to Ethernet II, configure the Ether Type parameter.

5. Save your changes and close the form.

8

Repeat [Step 7](#) to configure an additional MAC entry, if required.

9

Click Apply to save the changes.

10

Distribute the MAF to NEs, as required.

11

Close the open forms.

END OF STEPS

10.12 How do I configure a CPM filter?



Note: To perform this procedure, you require an account with an assigned Administrator scope of command role to the sitesec package, or a scope of command role with write access permission to the sitesec package.

The 7705 SAR does not support queue or MAC CPM filters.

10.12.1 Steps

1

Choose Administration→Security→NE CPM Filter from the NFM-P main menu. The NE CPM Filter form opens.

2

Click Create or choose a policy and click Properties. The CPM Filter (Create|Edit) form opens.

3

Configure the required parameters.

You can set the IP Administrative Status and IPv6 Administrative Status parameters to Up after you set the Scope parameter to cpm on the ACL IP and ACL IPv6 filter policies; see the *Classic Management User Guide*.

4

To configure an IPv4 filter entry, perform the following steps.

1. Click on the IPv4 Entries tab.
2. Click Create or choose an entry and click Properties. The CPM IP Filter Entry (Create|Edit) form opens.
3. Configure the required parameters.
4. Click Select to assign a Log ID to the CPM filter entry.
See the *NSP NFM-P User Guide* for information on configuring a Filter Log policy that employs this Log ID.
5. Click on the Filter Properties tab.
6. Configure the required parameters.
7. Save your changes and close the form.

5

Repeat [Step 4](#) to configure an additional IPv4 entry, if required.

6

To configure an IPv6 filter entry, perform the following steps.

1. Click on the IPv6 Entries tab.
2. Click Create or choose an entry and click Properties. The CPM IPv6 Filter Entry (Create|Edit) form opens.
3. Configure the required parameters.
4. Click Select to assign a Log ID to the CPM filter entry.
See the *NSP NFM-P User Guide* for information on configuring a Filter Log policy that employs this Log ID.
5. Click on the Filter Properties tab.
6. Configure the required parameters.
7. Save your changes and close the form.

7

Repeat [Step 6](#) to configure an additional IPv6 entry, if required.

8

To configure a MAC entry, perform the following steps.

1. Click Create or choose an entry and click Properties. The CPM MAC Filter Entry (Create|Edit) form opens.
2. Configure the required parameters.
3. Click Select to assign a Log ID to the CPM filter entry.
See the *NSP NFM-P User Guide* for information on configuring a Filter Log policy that employs this Log ID.
4. Click on the Filter Properties tab and configure the required parameters.
If you set the Frame Type parameter to e802dot2LLC, configure the parameters in the Match Criteria - DSAP SSAP panel.
If you set the Frame Type parameter to e802dot2SNAP, configure the parameters in the Match Criteria - SNAP panel.
If you set the Frame Type parameter to Ethernet II, configure the Ether Type parameter.
5. Save your changes and close the form.

9

Repeat [Step 8](#) to configure an additional MAC entry, if required.

10

To configure a queue entry, perform the following steps.

1. Click on the Queues tab.
2. Click Create or choose an entry and click Properties. The CPM Filter Queue Entry (Create|Edit) form opens.
3. Configure the required parameters.
4. Click on the CIR/PIR and Burst Size tab and configure the required parameters.
Ensure that the Committed Burst Size (KB) parameter value is lower than the Maximum Burst Size (KB) parameter value.
5. Save your changes and close the form.

11

Repeat [Step 10](#) to configure an additional queue entry, if required.

12

Click Apply to save the changes.

13

Distribute the filter to NEs, as required.

14 _____
Close the open forms.

END OF STEPS _____

10.13 How do I configure an NE DoS protection policy?

 **Note:** To perform this procedure, you require an account with an assigned Administrator scope of command role to the sitesec package, or a scope of command role with write access permission to the sitesec package.

10.13.1 Steps

- 1 _____
Choose Administration→Security→NE DoS Protection from the NFM-P main menu. The NE DoS Protection form opens.
- 2 _____
Click Create or choose a policy and click Properties. The NE DoS Protection (Create|Edit) form opens.
- 3 _____
Configure the required parameters.
- 4 _____
Perform the following steps to configure CFM frame-rate limiting, if required.
 1. Click on the CFM Rate Limiting tab.
 2. Click Create. The CfmRateLimiting (Create) form opens.
 3. Configure the required parameters:
 4. Click Add in the Op Code Set panel. The Select Property form opens.
Note: You must specify at least one Op Code value.
 5. Choose one or more Op Codes in the list and click OK.
 6. Save your changes and close the form.
- 5 _____
Click Apply to save the changes.
- 6 _____
Distribute the policy to NEs, as required.

7 _____
Close the open forms.

END OF STEPS _____

10.14 How do I view NE DoS protection violations?

10.14.1 Steps

- 1 _____
Choose Administration→Security→NE System Security from the NFM-P main menu. The Select Site form opens.
- 2 _____
Choose a managed device in the list and click OK. The NE System Security (Edit) form opens.
- 3 _____
Click on the NE DoS Protection tab.
- 4 _____
Perform one of the following to view a specific violation type.
 - a. Click on the Per MAC Source Violations tab to view a list of the violations associated with subscriber hosts according to MAC address.
 - b. Click on the Per IP Source Violations tab to view a list of the violations associated with subscriber hosts according to IP address.
 - c. Click on the Link Specific Port Violations tab to view a list of the violations at the port level. The following kinds of violations are listed:
 - violations that exceed the Link Rate Limit (pps) parameter value specified for the NE
 - violations that exceed the Port Overall Rate Limit (pps) parameter value specified for the NE.
 - d. Click on the Network Interface Violations tab to view a list of the violations for network interfaces that exceed the Overall Rate Limit (pps) parameter value specified in an associated NE DoS protection policy.
 - e. Click on the SAP Violations tab to view a list of the violations for SAPs that exceed the Overall Rate Limit (pps) parameter value specified in an associated NE DoS protection policy.
 - f. Click on the Video Router Context Violations tab to view a list of violations for virtual routers exceeding the per source limit on the NE.
 - g. Click on the Video Service Violations tab to view a list of violations for services exceeding the per source limit on the NE.

5 _____
Repeat [Step 4](#) as required to view another violation type.

6 _____
Close the NE System Security (Edit) form.

END OF STEPS _____

10.15 How do I configure an NE DDoS protection policy?

10.15.1 Steps

1 _____
Choose Administration→Security→NE DDoS Protection from the NFM-P main menu. The NE DDoS Protection form opens.

2 _____
Click Create or choose a policy and click Properties. The DDoS Protection Policy (Create|Edit) form opens.

 **Note:** For SAPs and access/network interfaces, click Search to list the default NE DDoS protection policies for Distributed CPU Protection (DCP). Select the appropriate access or network policy and click Properties to modify the default policy if required.

3 _____
Configure the required parameters.

 **Note:** A default port-type policy does not initially reside in the NFM-P, but is collected from a supporting NE during discovery synchronization. The port-type policy applies only for select port-based protocols, and is applied automatically to all ports when the policy is distributed to a supporting NE.

4 _____
To configure a static policer, perform the following steps.

1. Click on the Static Policers tab.
2. Click Create or choose an entry and click Properties. The Static Policer (Create|Edit) form opens.
3. Configure the required parameters.
4. If the Rate Type parameter is set to Kbps, configure the Rate Limit (Kb/s) and Buffer Space (Bytes) parameters in the Kbps panel. You can specify a default value for these parameters by selecting the Default check box.
5. If the Rate Type parameter is set to Packets, configure the Rate Limit (packets), Time Limit (seconds), and Initial Delay (packets) parameters in the Packets panel. You can specify a default value for the Rate Limit (packets) parameter by selecting the Default check box.

-
6. Configure the Exceed Action parameter. If you set this parameter to Discard or Low Priority, configure the Hold Down Duration (seconds) parameter.
 7. Click OK. The Static Policer form closes.

5

Repeat [Step 4](#) to configure an additional static policer, if required.

6

To configure a local monitoring policer, perform the following steps.

1. Click on the Local Monitoring Policer tab.
2. Click Create or choose an entry and click Properties. The Local Monitoring Policer (Create|Edit) form opens.
3. Configure the required parameters.
4. If the Rate Type parameter is set to Kbps, configure the Rate Limit (Kb/s) and Buffer Space (Bytes) parameters in the Kbps panel. You can specify a default value for these parameters by selecting the Default check box.
5. If the Rate Type parameter is set to Packets, configure the Rate Limit (packets), Time Limit (seconds), and Initial Delay (packets) parameters in the Packets panel. You can specify a default value for the Rate Limit (packets) parameter by selecting the Default check box.
6. Configure the Exceed Action parameter.
7. Click OK. The Local Monitoring Policer form closes.

7

Repeat [Step 6](#) to configure an additional local monitoring policer, if required.

8

To configure protocol mappings for policers, perform the following steps.

1. Click on the Protocols tab.
2. Click Create or select an entry and click Properties. The Protocols (Create|Edit) form opens.
3. Configure the required parameters.
4. Select a policer in the Enforcement panel.
Note: If the Type parameter is set to Static, you must choose a static policer. If the Type parameter is set to Shared, you must choose a shared policer. If the Type parameter is set to Dynamic, you must choose a local monitoring policer. However, if the Type parameter is set to Dynamic and the Local Monitoring Bypass parameter is enabled, you cannot specify a local monitoring policer.
5. If the Rate Type parameter is set to Kbps, configure the Rate Limit (Kb/s) and Buffer Space (Bytes) parameters in the Kbps panel. You can specify a default value for these parameters by selecting the Default check box.
6. If the Rate Type parameter is set to Packets, configure the Rate Limit (packets), Interval

(seconds), and Initial Delay (packets) parameters in the Packets panel. You can specify a default value for the Rate Limit (packets) parameter by selecting the Default check box.

7. Configure the Exceed Action parameter. If you set this parameter to Discard or Low Priority, configure the Hold Down Duration (seconds) parameter.
8. Save your changes and close the form.

9

Repeat [Step 8](#) to configure an additional protocol, if required.

10

Click Apply to save the changes.

11

Distribute the policy to NEs, as required.

12

Close the open forms.

END OF STEPS

10.16 How do I configure NE TLS client authentication?

10.16.1 Purpose

This procedure describes TLS client configurations for NEs. For TLS server configurations, see [10.17 “How do I configure NE TLS server authentication?”](#) (p. 245).

TLS configurations are distributed to NEs using the NFM-P policy framework; see “Policies overview” in the *NSP NFM-P User Guide*.

10.16.2 Steps

1

Choose Administration→Security→NE TLS Authentication from the NFM-P main menu. The NE TLS Authentications form opens.

2

Configure a TLS client cipher list.

1. To create a new client cipher list, click Create→TLS Client Cipher List. The TLS Client Cipher List (Create|Edit) form opens.

To modify an existing client cipher list, choose TLS Client Cipher List (NE Security) in the object drop down of the NE TLS Authentications form, click Search, select a cipher list, and click Properties.

-
2. If you are creating a new cipher list, enter a name for the Client Cipher List in the General tab.
 3. Click on the TLS Client Cipher List Param tab. You can configure up to eight parameter entries for the cipher list.
 4. Click Create, or choose an entry in the list and click Properties. The TLS Client Cipher List Param form opens.
 5. Configure the cipher list parameters.
 6. Save your changes and close the form.
 7. Click on the TLS 1.3 Client Cipher List Param tab. You can configure up to eight parameter entries for the cipher list.
 8. Click Create, or choose an entry in the list and click Properties. The TLS 1.3 Client Cipher List Param form opens.
 9. Configure the required parameters.
 10. Save your changes and close the form.
 11. Save your changes on the TLS Client Cipher List (Create|Edit) form and distribute the list to the required NEs.

3

Configure a TLS trust anchor profile.

1. To create a trust anchor profile, click Create→TLS Trust Anchor Profile. The TLS Trust Anchor Profile (Create|Edit) form opens.
To modify a trust anchor profile, choose TLS Trust Anchor Profile (NE Security) in the object drop-down of the NE TLS Authentications form, click Search, select a trust anchor profile, and click Properties.
2. If you are creating a new profile, configure the Trust Anchor Profile Name on the General tab.
3. Click on the TLS Trust Anchors tab to add PKI certificate authority profiles.
4. Click Create, or choose a Trust Anchor CA Profile entry in the list and click Properties. The TLS Trust Anchor Entry form opens.
5. Select a Certificate Authority Profile. At least one PKI certificate authority profile must be selected; see [10.31 “How do I configure a PKI certificate authority profile?” \(p. 264\)](#).
6. Save your changes and close the form.
7. Save your changes on the TLS Trust Anchor Profile (Create|Edit) form and distribute the profile to the required NEs.

4

Configure a TLS certificate profile.

1. To create a new TLS certificate profile, click Create→TLS Certificate Profile.

To modify an existing certificate profile, choose TLS Certificate Profile (NE Security) in the object drop down of the NE TLS Authentications form, click Search, select a certificate profile, and click Properties.

The TLS Certificate Profile (Create|Edit) form opens.

2. If you are creating a new certificate profile, configure the Displayed Name parameter on the General tab.
3. Click on the TLS Certificate Profile Entry tab and configure the required parameters.
4. Click on the Send Chain tab to add the required PKI certificate authority profiles.
5. Click Create. The TLS Certificate CA Profile Entry form opens.
6. Select a Certificate Authority Profile; see [10.31 “How do I configure a PKI certificate authority profile?” \(p. 264\)](#).
7. Save your changes and close the TLS Certificate CA Profile Entry form.
8. On the TLS Certificate Profile (Create|Edit) form, configure the Administrative State parameter if required.
9. Save your changes and distribute the list to the required NEs.

5



Note: The TLS client profile can be associated with a RADIUS server. For information, see [10.26 “How do I configure an NE RADIUS authentication policy?” \(p. 254\)](#).

Configure a TLS client profile.

1. To create a new TLS client profile, click Create→TLS Client Profile. The TLS Client Profile (Create|Edit) form opens.

To modify an existing client profile, choose TLS Client Profile (NE Security) in the object drop down of the NE TLS Authentications form, click Search, select a client profile, and click Properties.

2. If you are creating a new client profile, configure the Displayed Name parameter.
3. Select a Cipher List; see [Step 2](#).
4. Select a Trust Anchor Profile; see [Step 3](#).
5. Select a Certificate Profile; see [Step 4](#).
6. Select TLS client group list and TLS Client Signature List profiles.
7. Configure the required parameters.
8. Save your changes on the TLS Client Profile form and distribute the profile to the required NEs.

6

Close the NE TLS Authentications form.

END OF STEPS

10.17 How do I configure NE TLS server authentication?

10.17.1 Purpose

This procedure describes TLS server configurations for NEs. For TLS client configurations, see [10.16 “How do I configure NE TLS client authentication?”](#) (p. 243).

TLS configurations are distributed to NEs using the NFM-P policy framework; see “Policies overview” in the *NSP NFM-P User Guide*.

10.17.2 Steps

1

Choose Administration→Security→NE TLS Authentication from the NFM-P main menu. The NE TLS Authentications form opens.

2

Configure a TLS server cipher list.

1. To create a server cipher list, click Create→TLS Server Cipher List.

To modify a server cipher list, choose TLS Server Cipher List (NE Security) in the object drop-down of the NE TLS Authentications form, click Search, select a cipher list, and click Properties.

The TLS Server Cipher List (Create|Edit) form opens.

2. If you are creating a cipher list, configure the Displayed Name parameter on the General tab.
3. Click on the TLS Server Cipher List Param tab. You can configure up to 255 parameter entries for the cipher list.
4. Click Create, or choose an entry in the list and click Properties. The TLS Server Cipher List Param form opens.
5. Configure the required parameters.
6. Save your changes and close the TLS Server Cipher List Param form.
7. Click on the TLS 1.3 Server Cipher List Param tab. You can configure up to eight parameter entries for the cipher list.
8. Click Create, or choose an entry in the list and click Properties. The TLS 1.3 Server Cipher List Param form opens.
9. Configure the required parameters.
10. Save your changes and close the form.
11. Save your changes on the TLS Client Cipher List (Create|Edit) form and distribute the list to the required NEs.

3

Configure a TLS server profile.

1. To create a TLS server profile, click Create→TLS Server Profile.

To modify a server profile, choose TLS Server Profile (NE Security) in the object drop-down of the NE TLS Authentications form, click Search, select a server profile, and click Properties.

The TLS Server Profile (Create|Edit) form opens.

2. If you are creating a server profile, configure the Displayed Name parameter.
3. Select a Server Cipher List; see [Step 2](#).
4. Select a Certificate Profile; see [Step 4](#) in [10.16 “How do I configure NE TLS client authentication?”](#) (p. 243).
5. Select a Trust Anchor Profile; see [Step 3](#) in [10.16 “How do I configure NE TLS client authentication?”](#) (p. 243).
6. Configure the Re-negotiate Timer parameter if required.
7. Select a Common Name List; see [10.33 “How do I configure a PKI common name list?”](#) (p. 266).
8. Configure the required parameters.
9. Select TLS server signature list and TLS server group list profiles.
10. Save your changes on the TLS Server Profile form and distribute the profile to the required NEs.

4

Close the NE TLS Authentications form.

END OF STEPS

10.18 How do I configure TLS server group list?

10.18.1 Steps

1

Choose Administration→Security→NE TLS Authentication from the NFM-P main menu. The NE TLS Authentications form opens.

2

Click Create→TLS Server Group List. The TLS Server Group List, Global Policy (Create|Edit) form opens.

3

Configure the Displayed Name parameter on the General tab.

4

Click on the TLS 1.3 Server Group List Param tab.

1. Click Create, or choose an entry in the list and click Properties. The TLS 1.3 Server Group List Param, form opens.
2. Configure the required parameters.
3. Save your changes and close the form.

5

Save your changes on the TLS Server Group List, Global Policy form and distribute the list to the required NEs.

END OF STEPS

10.19 How do I configure TLS client group list?

10.19.1 Steps

1

Choose Administration→Security→NE TLS Authentication from the NFM-P main menu. The NE TLS Authentications form opens.

2

Click Create→TLS Client Group List. The TLS Client Group List, Global Policy (Create|Edit) form opens.

3

Configure the Displayed Name parameter on the General tab.

4

Click on the TLS 1.3 Server Group List Param tab.

1. Click Create, or choose an entry in the list and click Properties. The TLS 1.3 Server Group List Param, form opens.
2. Configure the required parameters.
3. Save your changes and close the form.

5

Save your changes on the TLS Client Group List, Global Policy form and distribute the list to the required NEs.

END OF STEPS

10.20 How do I configure TLS server signature list?

10.20.1 Steps

- 1 _____
Choose Administration→Security→NE TLS Authentication from the NFM-P main menu. The NE TLS Authentications form opens.
- 2 _____
Click Create→TLS Server Signature List. The TLS Server Signature List, Global Policy (Create|Edit) form opens.
- 3 _____
Configure the Displayed Name parameter on the General tab.
- 4 _____
Click on the TLS 1.3 Server Group List Param tab.
 1. Click Create, or choose an entry in the list and click Properties. The TLS 1.3 Server Group List Param, form opens.
 2. Configure the required parameters.
 3. Save your changes and close the form.
- 5 _____
Save your changes on the TLS Server Signature List, Global Policy form and distribute the list to the required NEs.

END OF STEPS _____

10.21 How do I configure TLS client signature list?

10.21.1 Steps

- 1 _____
Choose Administration→Security→NE TLS Authentication from the NFM-P main menu. The NE TLS Authentications form opens.
- 2 _____
Click Create→TLS Client Signature List. The TLS Client Signature List, Global Policy (Create|Edit) form opens.
- 3 _____
Configure the Displayed Name parameter on the General tab.

4

Click on the TLS 1.3 Server Group List Param tab.

1. Click Create, or choose an entry in the list and click Properties. The TLS 1.3 Server Group List Param, form opens.
2. Configure the required parameters.
3. Save your changes and close the form.

5

Save your changes on the TLS Client Signature List, Global Policy form and distribute the list to the required NEs.

END OF STEPS

10.22 How do I configure a site user profile?

i **Note:** To perform this procedure, you require an account with an assigned Administrator scope of command role to the sitesec package, or a scope of command role with write access permission to the sitesec package.

10.22.1 Steps

1

Choose Administration→Security→NE User Profiles from the NFM-P main menu. The NE User Profiles form opens.

2

Click Create or choose a profile and click Properties. The Site User Profile (Create|Edit) form opens.

3

Configure the required parameters.

i **Note:** You require LI user privileges to configure the LI Profile parameter.

4

Perform the following steps.

1. Click on the Entries tab.
2. Click Create or choose an entry and click Properties. The Site User Profile Match Entry (Create|Edit) form opens.
3. Configure the required parameters.

The Match String parameter value is a CLI command prefix that defines the scope of the user profile. For example, when you set the match string to “config” and specify the deny action, the user profile cannot use any CLI commands that begin with the word “config”.

4. Save your changes and close the form.

5

Repeat [Step 4](#) to configure an additional match entry, if required.

6

Click Apply to save the changes.

7

Distribute the profile to NEs, as required.

8

Close the open forms.

END OF STEPS

10.23 How do I configure a user account on a managed device?



Note: To perform this procedure, you require an account with an assigned Administrator scope of command role to the sitesec package, or a scope of command role with write access permission to the sitesec package.

10.23.1 Steps

1

Choose Administration→Security→NE User Configuration from the NFM-P main menu. The NE User Configuration form opens.

2

Click Create or choose a user and click Properties. The NE User (Create|Edit) form opens.

3

Configure the required parameters.



Note: The SNMP option of the Access parameter is not valid for NEs that are managed using SNMPv2.

4

If the Console option of the Access parameter is selected, perform the following steps to specify one or more site user profiles for the user account.

1. Click on the Console Profiles tab.
2. Use the Select buttons to specify up to eight profiles

5

When an SNMPv3 user account and group exist on a managed device, you can configure the user authentication parameters. To configure the parameters, perform the following steps.

i **Note:** If MD5 or SHA authentication and DES or AES privacy is used, ensure that the keys are on the device and associated with the SNMPv3 user group.

1. Click on the SNMPv3 tab.
2. Configure the required parameters.

i **Note:** Ensure the NEs support a valid combination of authentication and privacy protocols. See the NE documentation or *NSP NFM-P User Guide* to review the disallowed combinations.

6

To specify an RSA key for use by SFTP on a 7750 SR MG, perform the following steps.

i **Note:** Only the 7750 SR MG supports RSA key configuration.

1. Click on the RSA Key tab.
2. Click Create. The RSA Key (Create) form opens.
3. Configure the parameters.
4. Save your changes and close the form.

7

Click Apply to save the changes.

8

Distribute the account to NEs, as required.

9

Close the open forms.

END OF STEPS

10.24 How do I configure an NE password policy?

10.24.1 When to use

Perform this procedure to configure NE password parameters such as length, special characters, maximum attempts, expiry conditions, lockout time, and other site password policy considerations.

i **Note:** To perform this procedure, you require an account with an assigned Administrator scope of command role to the sitesec package, or a scope of command role with write access permission to the sitesec package.

10.24.2 Steps

- 1 _____
Choose Administration→Security→NE Password Policy from the NFM-P main menu. The NE Password Policy form opens.
- 2 _____
Click Create or choose an entry and click Properties. The Site Password Policy (Create|Edit) form opens.
- 3 _____
Configure the required parameters.
- 4 _____
Specify the types and order of password authentication to be used to verify the user account password using the Authentication Order 1 through 3 parameters. Set the order from the most preferred authentication method to the least preferred.
- 5 _____
Configure the password complexity rules using the parameters in the Complexity Rules panel.
- 6 _____
Click Apply to save the changes.
- 7 _____
Distribute the policy to NEs, as required.
- 8 _____
Close the open forms.

END OF STEPS _____

10.25 How do I configure an LDAP site authentication policy?



Note: Lightweight Directory Access Protocol (LDAP) is an authentication, authorization, and accounting (AAA) protocol. An LDAP AAA server stores and manages public keys. When a user needs to SSH to an NE SR-OS via a public key infrastructure, the SR NE obtains the key from the LDAP AAA server and authenticates the user with that key. An SR NE can only have one policy of this type.

10.25.1 Steps

- 1 _____
Choose Administration→Security→NE LDAP Authentication from the NFM-P main menu. The NE LDAP Authentication form opens.
- 2 _____
Click Create or choose an entry and click Properties. The Site LDAP Policy (Create|Edit) form opens.
- 3 _____
Configure the required parameters.
- 4 _____
Click on the Servers tab.
- 5 _____
Perform the following steps to specify a LDAP server:
 1. Click Create or choose an entry and click Properties. The Site LDAP Server (Create | Edit) form opens.
 2. Configure the required parameters.
Note:
Refer to [10.16 “How do I configure NE TLS client authentication?” \(p. 243\)](#) for information regarding creation of NE TLS profiles.
 3. Save your changes and close the form.
- 6 _____
Click Apply to save the changes.
- 7 _____
Distribute the policy to NEs, as required.
- 8 _____
Close the forms.

END OF STEPS _____

10.26 How do I configure an NE RADIUS authentication policy?



Note: See the appropriate RADIUS documentation for information about configuring a RADIUS server.

10.26.1 Steps

1 _____
Choose Administration→Security→NE RADIUS Authentication from the NFM-P main menu. The NE RADIUS Authentication form opens.

2 _____
Click Create or choose an entry and click Properties. The Site RADIUS Policy (Create|Edit) form opens.

3 _____
Configure the required parameters.

4 _____
Click on the Servers tab.

5 _____
Perform the following steps to specify a RADIUS server.

 **Note:** To associate a RADIUS server with a TLS client profile, see [10.16 “How do I configure NE TLS client authentication?”](#) (p. 243).

1. Click Create or choose an entry and click Properties. The Site RADIUS Server (Create | Edit) form opens.
2. Configure the required parameters.
3. Save your changes and close the form.

6 _____
Repeat [Step 5](#) to specify an additional RADIUS server, if required.

 **Note:** You can specify up to five RADIUS servers.

7 _____
Click Apply to save the changes.

8 _____
Distribute the policy to NEs, as required.

9 _____
Close the open forms.

END OF STEPS _____

10.27 How do I configure an NE TACACS+ authentication policy?

i **Note:** See the appropriate TACACS+ documentation for more information about configuring TACACS+ servers.

10.27.1 Steps

1 _____
Choose Administration→Security→NE TACACS+ Authentication from the NFM-P main menu. The NE TACACS+ Authentication form opens.

2 _____
Click Create or choose an entry and click Properties. The Site TACACS+ Policy (Create|Edit) form opens.

3 _____
Configure the required parameters.
The Use Privilege Map parameter is configurable when the Enable Authorization parameter is set to true.

4 _____
Click on the Privilege Level Map tab.

5 _____
Click Create. The Privilege Level Map (Create) form opens.

6 _____
Configure the Privilege Level parameter.

7 _____
Choose a user profile.

8 _____
Click on the Servers tab.

9 _____
Perform the following steps to specify a TACACS+ server.

1. Click Create or choose an entry and click Properties. The Site TACACS+ Server (Create | Edit) form opens.
2. Configure the required parameters.
3. Save your changes and close the form.

-
- 10 Repeat [Step 9](#) to specify an additional TACACS+ server, if required.

 **Note:** You can specify up to five TACACS+ servers.

- 11 Click Apply to save the changes.

- 12 Distribute the policy to NEs, as required.

- 13 Close the open forms.

END OF STEPS

10.28 How do I configure an OmniSwitch RADIUS, TACACS+, or LDAP security authentication policy?

10.28.1 Steps

- 1 Choose Administration→Security→NE AOS Security Authentication from the NFM-P main menu. The NE AOS Security Authentication form opens.

- 2 Click Create or choose an entry and click Properties. The Site AOS Security Policy (Create|Edit) form opens.

- 3 Configure the required parameters.

- 4 Click Apply to save the changes.

- 5 Distribute the policy to NEs, as required.

- 6 Close the open forms.

END OF STEPS

10.29 How do I configure device system security settings?

10.29.1 Steps

1

Choose Administration→Security→NE System Security from the NFM-P main menu. The Select Site form opens.

2

Select a managed device and click OK. The NE System Security (Edit) form opens.



Note: Items that appear on the NE System Security (Edit) form are device-dependent. Not all configuration form tabs and parameters in this procedure apply to all devices.

3

To configure the FTP, Telnet, or SSH server parameters, click on the Servers Configuration tab.



Note: The 7705 SAR may become temporarily unreachable when enabling SSH and starting the SSH server on the device.

4

To configure allowed SSH ciphers, perform the following.

1. Click on the SSH Cipher List tab.
2. Click Create in the Client tab. The SSH Client Cipher List (Create) form opens.
3. Configure the required parameters.
4. Save and close the form.
5. Click on the Server tab and click Create. The SSH Server Cipher List (Create) form opens.
6. Configure the required parameters.
7. Save and close the form.

5

To configure SSH key regeneration, perform the following.

1. Click on the SSH Key Re Exchange tab.
2. Click on the Client tab and configure the required parameters.
3. Click on the Server tab and configure the required parameters.

6

To configure the CPM hardware queuing for BGP or T-LDP peers, click on the CPM Per-Peer-Queuing tab.

7

To configure user profiles, click on the System User Template tab. Otherwise, go to [Step 20](#) .

The default System User radius_default and tacplus_default templates are listed.

8

Select the appropriate default template and click Properties. The System User Template (Edit) form opens.

9

Configure the required parameters.

10

If you intend to use the default Template Profile, go to [Step 20](#) .

11

Click Select in the Template Profile panel to choose a template profile.

12

If you choose the administrative template, go to [Step 20](#) .

13

Click Create. The Site User Profile (Create) form opens.

14

Configure the required parameters.

15

Click on the Entries tab.

16

Perform the following steps.

1. Click Create. The Site User Profile Match Entry (Create) form opens.
2. Configure the required parameters.

The Match String parameter value is a CLI command prefix that defines the scope of the user profile. For example, when you set the match string to “config” and specify the deny action, the user profile cannot use any CLI commands that begin with the word “config”.

17

Repeat [Step 16](#) to specify an additional match entry, if required.

18

Save your changes and close the form.

19 _____
Close the System User Template (Edit) form.

20 _____
To configure global DoS protection, click on the NE DoS Protection tab.

21 _____
Configure the required parameters.

 **Note:** PIM in an MVPN on the egress DR does not switch traffic from the (*,G) to the (S,G) tree if protocol protection is enabled, and if PIM is not enabled on the ingress network interface. Enable the Block PIM Tunneled parameter to enable extraction and processing of PIM packets that arrive from a tunnel, for example, an MPLS or GRE tunnel, on a network interface.

22 _____
Click on the following child tabs, as required, to view the DoS violations.

- Per MAC Source Violations
- Per IP Source Violations
- Link Specific Port Violations
- Network Interface Violations
- SAP Violations
- SDP Violations
- Video Router Context Violations
- Video Service Violations

23 _____
Click on the VPRN Network Exceptions tab to configure rate limits for VPRN network exceptions.

24 _____
Configure the required parameters.

25 _____
Save your changes and close the NE System Security (Edit) form.

26 _____
Close the NE System Security form.

END OF STEPS _____

10.30 How do I configure and manage PKI site security on an NE?

10.30.1 Purpose

Perform this procedure to create the required DSA or RSA keypair and CA request on an NE to enable PKI security between peers, and to manage keys, certificates, and CRLs.

PKI encryption is required for functions such as IPsec, which use X.509 certificate-based authentication. The following devices support PKI encryption:

- 7450 ESS
- 7705 SAR
- 7750 SR MG
- 7750 SR
- 7750 SR
- 7705 SAR-Hm
- 7250 IXR

 **Note:** The displayed parameters vary depending on the NE type, release, and the settings of other parameters.

10.30.2 Steps

- 1 _____
Choose Administration→Security→NE PKI Authentication→Site Public Key Infrastructure from the NFM-P main menu. The Select Site form opens.
- 2 _____
Choose a managed NE and click OK. The Site Security Public Key Infrastructure (Edit) form opens.
- 3 _____
Configure the required parameters.
- 4 _____
Click Apply to save the changes.
- 5 _____
Perform the following steps to generate a PKI keypair that is stored in a file on an NE compact flash drive.
 1. Choose Admin Certificate→Generate Keypair from the More Actions button menu. The Admin Certificate Generate Keypair form opens.
 2. Configure the required parameters.
 3. Click Execute. The keypair is generated and stored.

-
4. Close the form.

6

Perform the following steps to generate local PKCS#10 certificate request on a local compact flash drive.

1. Choose Admin Certificate→Generate Local Certificate Request from the More Actions button menu. The Admin Certificate Generate Local Certificate Request form opens.
2. Configure the required parameters.
3. Click Execute. The local request is generated.
4. Close the form.

7

If you want the certificate signed by a CA, FTP the request file to the CA and use the CA-signed certificate in the following steps.

8

Perform the following steps to convert the certificate file to the required format for the NE.

1. Choose Admin Certificate→Import File from the More Actions button menu. The Admin Certificate Import File form opens.
2. Configure the required parameters.
3. Click Execute. The file is imported.
4. Close the form.

9

To convert a certificate, keypair, or CRL file on the NE to another format, perform the following steps.

1. Choose Admin Certificate→Export File from the More Actions button menu. The Admin Certificate Export File form opens.
2. Configure the required parameters.
3. Click Execute. The file is exported.
4. Close the form.

10

To display the content of a certificate, keypair, or CRL file in plain text, perform the following steps.

1. Choose Admin Certificate→Display File from the More Actions button menu. The Admin Certificate Display File form opens.
2. Configure the required parameters.

Note: If you are displaying key file content, only the Key Size and Key Type are displayed.

Note: You must configure the Password parameter if the file uses PKCS#12 encryption.

3. Click Execute. The file content is displayed.

-
4. Close the form.

11

To reload a certificate or keypair file from a local compact flash drive, perform the following steps.

1. Choose Admin Certificate→Reload File from the More Actions button menu. The Admin Certificate Reload File form opens.
2. Configure the required parameters.
3. Click Execute. The file content is reloaded.
4. Close the form.

12

To clear the OCSP cache, perform the following steps.

1. Choose Admin Certificate→Clear OCSP Cache from the More Actions button menu. The Admin Certificate Clear OCSP Cache form opens.
2. Configure the required parameters.
3. Click Execute. The file content is reloaded.
4. Close the form.

13

To import a Secure ND RSA keypair, perform the following steps.

1. Choose Admin Certificate→Secure ND Import from the More Actions button menu. The Admin Certificate Secure ND Import form opens.
2. Configure the required parameters.
3. Click Execute. The keypair is imported.
4. Close the form.

14

To export the Secure ND RSA keypair, perform the following steps.

1. Choose Admin Certificate→Secure ND Export from the More Actions button menu. The Admin Certificate Secure ND Export form opens.
2. Click Execute. The keypair is exported.
3. Close the form.

15

To perform CMP2 actions, see [10.37 “How do I perform CMPv2 actions?” \(p. 270\)](#) .

16

To enroll EST profile, perform the following steps.

1. Choose Admin Certificate→Enroll EST Profile from the More Actions button menu. The Admin Certificate Enroll EST Profile form opens.

-
2. Configure the required parameters.
 3. Click Execute. The file content is enrolled.
 4. Close the form.

17

To EST distribute CA Certificate, perform the following steps.

1. Choose Admin Certificate→EST Distribute CA Certificate from the More Actions button menu. The Admin Certificate EST Distribute CA Certificate form opens.
2. Configure the required parameters.
3. Click Execute. The file content is distributed.
4. Close the form.

18

To renew EST profile, perform the following steps.

1. Choose Admin Certificate→Renew EST Profile from the More Actions button menu. The Admin Certificate Renew EST Profile form opens.
2. Configure the required parameters.
3. Click Execute. The file content is renewed.
4. Close the form.

19

Close the Site Security Public Key Infrastructure (Edit) form.

END OF STEPS

10.31 How do I configure a PKI certificate authority profile?

10.31.1 Steps

 **Note:** The displayed parameters vary depending on the NE type, release, and the settings of other parameters.

1

Choose Administration→Security→NE PKI Authentication→PKI Certificate Authority Profiles from the NFM-P main menu. The PKI Certificate Authority Profiles form opens.

2

Click Create. The Certificate Authority Profile (Create) form opens.

3

Configure the required parameters.

-
- 4 _____
Click on the CMPv2 tab and configure the required parameters.
- 5 _____
To create a CMP key, perform the following steps.
- i** **Note:** A key that is created locally on an NE, for example, using a CLI, is not sent to the NFM-P, and is displayed on the Certificate Authority Profile form as N/A. Any N/A keys on an NE must be deleted before the profile can be distributed to the NE.
1. Click Create. The CMP Key List (Create) form opens.
 2. Configure the parameters.
 3. Save your changes and close the form.
- 6 _____
To configure automatic CRL file download, perform the following.
1. Click on the Auto CRL Update tab and click Create. The Auto CRL Update form opens.
 2. Configure the required parameters.
 3. To specify a URL for the CRL file, click on the Create button in the URL entries panel and configure the parameters in the CRL URL Entry form. See [10.36 “How do I create a file transmission profile?” \(p. 269\)](#) for information about creating a file transmission profile to use with the CRL URL entry.
 4. Save your changes and close the form.
- 7 _____
Click Apply to save your changes.
- 8 _____
Distribute the policy to NEs, as required.
- 9 _____
Close the open forms.
- END OF STEPS _____

10.32 How do I configure the automatic renewal of the PKI certificate?

10.32.1 Automatic renewal

Before a PKI certificate expires, you can configure the automatic generation of a new CMP key and use an enrollment protocol (for example, CMPv2 or EST) to obtain a new certificate from the CA.

10.32.2 Steps

- 1 _____
Choose Administration→Security→NE PKI Authentication→PKI Certificate Authority Profiles from the NFM-P main menu. The PKI Certificate Authority Profiles form opens.
- 2 _____
Click Create. The Certificate Authority Profile (Create) form opens.
- 3 _____
Configure the required parameters.
- 4 _____
Click on the CMPv2 tab.
- 5 _____
Configure the required parameters and click OK.
- 6 _____
Choose Administration→Security→NE PKI Authentication→Certificate Update Profile. The Certificate Update Profile form opens.
- 7 _____
Click Create. The Certificate Update Profile, Global Policy (Create) form opens.
- 8 _____
Configure the required parameters. Select the certificate authority profile that you created in [Step 3](#) and click OK.
- 9 _____
Choose Administration→Security→NE PKI Authentication→Certificate Auto Update Profile. The Certificate Auto Update Profile form opens.
- 10 _____
Click Create. The Certificate Auto Update Profile, Global Policy (Create) form opens.
- 11 _____
Configure the required parameters. Select the certificate update profile that you created in step [Step 8](#) and click OK.
- 12 _____
Update and execute the admin certificate:

1. Choose Administration→Security→NE PKI Authentication→Site Public Key Infrastructure from the NFM-P main menu. The Site Public Key Infrastructure form opens.
2. Choose an NE in the list and click OK. The Site Security Public Key Infrastructure (Edit) form opens.
3. Configure the required parameters.
4. Choose Admin Certificate→Update certificate. The Admin Certificate Update Certificate form opens.
5. Configure the certificate auto update profile that you created in [Step 8](#).
6. Click Execute.

13

Close the forms.

END OF STEPS

10.33 How do I configure a PKI common name list?

i **Note:** PKI configurations are distributed to NEs using the NFM-P policy framework; see “Policies overview” in the *NSP NFM-P User Guide*.

10.33.1 Steps

1

Choose Administration→Security→NE PKI Authentication→PKI Common Name List from the NFM-P main menu. The PKI Common Name List form opens.

2

Click Create, or choose an entry in the list and click Properties. The Common Name List (Create|Edit) form opens.

3

If you are creating a common name list, configure the Displayed Name parameter.

4

Click on the Common Name List Entry tab and configure entries, as required.

1. Click Create, or choose an entry in the list and click Properties. The Common Name List Entry (Create|Edit) form opens.
2. Configure the required parameters.
3. Save your changes and close the Common Name List Entry (Create|Edit) form.

5

Click on the General tab and distribute the policy to NEs, as required.

6 _____
Close the open forms.

END OF STEPS _____

10.34 How do I configure an Enrollment over Secure Transport profile?

 **Note:** This is applicable to 7250 IXR only.

10.34.1 Steps

- 1 _____
Choose Administration→Security→NE PKI Authentication→Enrollment over Secure Transport from the NFM-P main menu. The Enrollment over Secure Transport form opens.
- 2 _____
Click Create, or choose an entry in the list and click Properties. The Enrollment over Secure Transport (Create|Edit) form opens.
- 3 _____
Configure the required parameters.
- 4 _____
If you are creating an Enrollment over Secure Transport profile, configure the Profile parameter.
- 5 _____
To specify a File Transmission Profile, click on the Select button.
- 6 _____
Click Create, or choose an entry in the list and click Properties. The File Transmission Profile (Create|Edit) form opens.
See [10.36 “How do I create a file transmission profile?” \(p. 269\)](#) for information about creating a File Transmission Profile to use with the Enrollment over Secure Transport profile.
- 7 _____
To specify a TLS Client Profile, click on the Select button.
- 8 _____
Click Create, or choose an entry in the list and click Properties. The TLS Client Profile (Create|Edit) form opens.
See [Step 5](#) for information about creating a TLS Client profile to use with the Enrollment over Secure Transport profile.

9 _____
Click Apply to save your changes.

10 _____
Distribute the policy to NEs, as required.

11 _____
Close the open forms.

END OF STEPS _____

10.35 How do I add an HSM to the NFM-P?

10.35.1 Purpose

Perform this procedure to add an 1830 SMS netHSM hardware security module to the NFM-P. In order to add an HSM:

- A user password in the form of a PKCS #11 PIN must be set.
- An HSM configuration file must be in the following directory on each NFM-P main server station:
`/opt/nsp/nfmp/server/nms/config/hsm/pkcs11`
- HSM must be enabled in each main server configuration, as described in the *NSP Installation and Upgrade Guide* system installation procedures.

10.35.2 Steps

1 _____
Choose Administration→Security→Hardware Security Module from the NFM-P main menu. The Hardware Security Module form opens.

2 _____
Click Create→Hardware Security Module. The HSMConfig (Create) form opens.

3 _____
Configure the parameters.

4 _____
Click OK.

5 _____
Test the connection to the HSM, if required.
1. In the Hardware Security Module list form, choose an HSM object and click Properties.
2. Click Test Connection to HSM.
The test results are displayed.

-
- 6 Save your changes and close the forms.

END OF STEPS

10.36 How do I create a file transmission profile?

10.36.1 Purpose

Follow this procedure to create a file transmission profile for use with a CRL URL entry when configuring a PKI certificate authority profile to use automatic CRL file download.

10.36.2 Steps

- 1 Choose Policies→ISA Policies→File Transmission Profile from the NFM-P main menu. The File Transmission Profile form opens.
- 2 Configure the required parameters.
- 3 Save your changes and close the form.

END OF STEPS

10.37 How do I perform CMPv2 actions?

10.37.1 Purpose

CMP is a protocol that runs between a Certification Authority, or CA, and an end entity to provide certificate management functions over HTTP.

10.37.2 Steps

- 1 Choose Administration→Security→NE PKI Authentication→Site Public Key Infrastructure from the NFM-P main menu. The Select Site form opens.
- 2 Choose an NE in the list and click OK. The Site Security Public Key Infrastructure (Edit) form opens.
- 3 Click Admin Certificate and choose Perform CMPv2 Actions. The Admin Certificate form opens.

4

Perform one of the following to configure the CA Profile Name parameter.

- a. Select a CA profile.
- b. Enter the profile name.

CMPv2 actions

5

Select a CMPv2 action from the drop-down menu beside the Type parameter in the Action panel. The following table lists the available CMPv2 actions. You can view the status of the last CMPv2 action performed on this site in the Last Action Status panel.

Table 10-1 CMPv2 actions

Action	See step
"Initial Registration" (p. 271)	Step 6
"Certificate Request" (p. 271)	Step 10
"Key Update" (p. 272)	Step 14
"Poll" (p. 272)	Step 18
"Clear Request" (p. 272)	Step 20
"Abort Request" (p. 272)	Step 22
"Manually Update CRL files" (p. 273)	Step 24

Initial Registration

6

Configure the required parameters in the Action panel.

7

Perform one of the following:

- a. To perform an initial registration using a password, configure the required parameters in the Protection Algorithm - using Password panel.
- b. To perform an initial registration using a certificate, configure the required parameters in the Protection Algorithm - using Certificate panel.

8

Click Apply to perform the action.

9

Go to [Step 26](#) .

Certificate Request

10 _____

Configure the required parameters in the Action panel.

11 _____

Configure the required parameters in the Protection Algorithm - using Certificate panel.

12 _____

Click Apply to perform the action.

13 _____

Go to [Step 26](#) .

Key Update

14 _____

Configure the required parameters in the Action panel.

15 _____

Configure the required parameters in the Protection Algorithm - using Certificate panel.

16 _____

Click Apply to perform the action.

17 _____

Go to [Step 26](#) .

Poll

18 _____

Click Apply to send the poll request.

19 _____

Go to [Step 26](#) .

Clear Request

20 _____

Click Apply to send the clear request.

21 _____
Go to [Step 26](#) .

Abort Request

22 _____
Click Apply to send the abort request.

23 _____
Go to [Step 26](#) .

Manually Update CRL files

24 _____
Configure the Certificate Authority Profile parameter.

25 _____
Click on the Execute button to send the update request.

26 _____
Close the open forms.

END OF STEPS _____

10.38 How do I delete a security policy?



Note: When you delete site management access filter policies in which the Action parameter is set to deny, ensure that you modify the policy to set the parameter to permit before it is deleted, otherwise, the NFM-P may be isolated.

You cannot remove a site management access filter if the filter administrative state is up and the default action of the filter is set to deny or deny host unreachable.

If you attempt to delete an OmniSwitch RADIUS or TACACS+ security policy that is applied to an authentication service, the NFM-P generates a deployment error. You must use the OmniSwitch CLI to delete the policy from the authentication service before you can delete the policy from the NFM-P.

10.38.1 Steps

- 1 _____
- Choose the appropriate policy from one of the following.
- The Administration→Security→*option* NFM-P main menu
 - The Policies→AAA Policies→*option* NFM-P main menu
- The appropriate form opens.

-
- 2 _____
Set the filter criteria, if applicable.
 - 3 _____
Click Search. A policy list opens.
 - 4 _____
Choose a policy from the list.
 - 5 _____
Click Delete.
 - 6 _____
Click Yes. The policy is deleted.

END OF STEPS _____

10.39 How do I manually unlock a user account?

10.39.1 Steps

- 1 _____
From the NFM-P main menu, choose Administration→Security→NE User Configuration. The NE User Configuration form opens.
- 2 _____
Click Search. A list of user accounts appears.
- 3 _____
Perform one of the following:
 - a. To unlock an NFM-P user, choose a user and click Unlock User. The user account is unlocked.
 - b. To unlock the local definition of a user on an NE, perform the following steps.

Use this method to unlock a user account that is still within the lockout time period. The lockout time is set in [10.24 "How do I configure an NE password policy?" \(p. 252\)](#).

 1. Choose a user account and click Properties. The NE User form opens.
 2. Click on the Local Definitions tab.
 3. Click Search. A list of NEs with local definitions for the user appears.
 4. Choose an NE and click Unlock User. The user account on the selected NE is unlocked.
 5. Close the NE User form.

-
- 4 _____
Close the NE User Configuration form.

END OF STEPS _____

10.40 How do I clear the password history of a user on a managed device?

10.40.1 Steps

- 1 _____
Choose Administration→Security→NE User Configuration from the NFM-P main menu. The NE User Configuration form opens.
- 2 _____
Configure the filters and click Search. A list of configured users appears.
- 3 _____
Select a user and click Properties. The NE User (Edit) form opens.
- 4 _____
Click on the Local Definitions tab. A list of sites with local definitions for the selected user appears.
- 5 _____
Select one or more sites and click Clear Password History. A dialog box appears.
- 6 _____
Click Yes to confirm the operation. The password history for the selected user at the specified sites is cleared.
- 7 _____
Click OK. The NE User (Edit) form closes.

END OF STEPS _____

10.41 How do I clear collected statistics on a CPM filter?

10.41.1 Steps

- 1 _____
From the NFM-P main menu, choose Administration→Security→NE CPM Filter. The CPM Filter form appears.

-
- 2 _____
Click Search. A list of CPM filters appears.
 - 3 _____
Choose a CPM filter and click Properties. The CPM Filter (Edit) form appears.
 - 4 _____
Click on the Local Definitions tab.
 - 5 _____
Configure the filters and click Search. A list of CPM filter local definitions appears.
 - 6 _____
Choose a local definition and click Properties. The CPM Filter Local Policy form appears.
 - 7 _____
Click on the IPv4 Entries, IPv6 Entries, MAC Entries or Queues tab, depending on the type of statistic you need to clear.
 - 8 _____
Configure the filters and click Search. A list of filter entries appears.
 - 9 _____
Perform one of the following:
 - a. To clear specific entries, choose the entries you need to clear and click Clear Statistics on Entry.
 - b. To clear all entries, choose an entry and click Clear Statistics on All Entries. This button is not available in the Queues tab.
 - 10 _____
To view the status of all clear requests, perform the following:
 1. Click on the Clear Statistics Status tab.
 2. Configure the filters, and click Search. A list of clear requests appears.
 3. Choose a clear request and click Properties. The status of the clear request appears.
 - 11 _____
Close the CPM Filter Local Policy, CPM Filter (Edit) and CPM Filter forms.

END OF STEPS _____

10.42 How do I manage OCSP cache entries on an NE?

10.42.1 Steps

- 1 _____
Choose Administration→Security→NE PKI Authentication→Site Public Key Infrastructure from the NFM-P main menu. The Select Site form opens.
- 2 _____
Choose a managed device in the list and click OK. The Site Security Public Key Infrastructure (Edit) form opens.
- 3 _____
Click on the OCSP Cache Entries tab.
- 4 _____
Click Search. A list of OCSP cache entries for the site opens.
- 5 _____
To clear cache entries, perform the following.
 1. Click Admin Certificate and choose Clear OCSP Cache. The Admin Certificate Clear OCSP Cache form opens.
 2. Enter the Entry ID number of the cache entry you need to clear in the Entry ID parameter. To clear all entries, leave the parameter blank.
 3. Click Execute. The results of the clear operation appear in the results panel.
 4. Click Close. The Admin Certificate Clear OCSP Cache form closes.
- 6 _____
Click OK or Cancel. The Site Security Public Key Infrastructure (Edit) form closes.

END OF STEPS _____

10.43 What is TCP enhanced authentication?

10.43.1 Overview



CAUTION

Service Disruption

It is recommended that you use only the NFM-P to create keys and key chains. Do not create a key or key chain directly on a managed NE using another interface, for example, a CLI. The NFM-P cannot obtain a TCP key secret value from an NE during resynchronization, so it cannot specify the key for use on another NE.

If a local NE key chain and the associated global NFM-P key chain differ after a resynchronization, the NFM-P raises an alarm.

This topic describes the NFM-P support of TCP enhanced authentication for NEs, based on the MD5 encryption mechanism described in RFC 2385, and the TCP Authentication Option (TCP-AO) as defined in RFC 5925 and 5926. NFM-P TCP enhanced authentication allows the use of powerful algorithms for authenticating routing messages.

The NFM-P uses a TCP extension to enhance BGP and LDP security by verifying administrative access at each end of a TCP connection. TCP peers update authentication keys during the lifetime of a connection.

An NFM-P operator with administrative privileges can create, delete, modify, and distribute TCP enhanced authentication components, and can perform an audit of a local key chain to compare it with the associated global key chain or other local key chains. The NFM-P TCP enhanced authentication components are called keys and key chains.

Global key chains are created in Draft mode. This allows operators to verify that the key chain is correctly configured before distribution to NEs. When the key chain is approved for distribution, you can change the global key chain to Released mode, which also distributes the key chain to existing local definitions. The NFM-P saves the latest released version of the global key chain.

10.43.2 TCP keys and key chains

A key is a data structure that is used to authenticate TCP segments. One or more keys can be associated with a TCP connection. Each key contains an identifier, a shared secret, an algorithm identifier, and information that specifies when the key is valid for authenticating the inbound and outbound segments.

A key chain is a list of up to 64 keys that is associated with a TCP connection. Each key within a key chain contains an identifier that is unique within the key chain. You can use the NFM-P to distribute a global key chain to multiple NEs and assign a key to multiple BGP or LDP instances.

The NFM-P treats global and local key chain management as it does policy management; depending on the distribution mode configuration of a local key chain, when you modify a global key chain using the NFM-P, all local instances can be updated to ensure that all instances of the key chain in the network are synchronized. See “Policies overview” in the *NSP NFM-P User Guide* for information about global and local policy instances, policy distribution and distribution modes, and local policy audits.

When the NFM-P attempts to synchronize the keys in a global key chain with the keys on an NE, the NE does not return the secret key value. After a key chain is deployed to an NE, the shared secret and the encryption algorithm cannot be modified. You can delete a key chain or key only when it is not in use by a protocol.

You can specify whether an NE uses a TCP key for sending packets, receiving packets, or both. Using keys that are configured for both, or send-receive, is general good practice because communication between NEs cannot be affected by assigning the wrong key type.

There are two classes of TCP keys:

- Active
- Eligible

Active keys

A key set contains one active key. An active key is a key that TCP uses to generate authentication information for outbound segments. You cannot delete the active key in a keychain.

Eligible keys

Each set of keys, called a key chain, contains zero or more eligible keys. An eligible key is a key that TCP uses to authenticate inbound segments.

10.44 Workflow: configure TCP enhanced authentication for NEs

10.44.1 Stages

- 1 _____
Create a global key chain that contains at least one key; see [10.45 “How do I configure a global TCP key chain?”](#) (p. 280) .
- 2 _____
Distribute the key chain to the NEs; see [10.46 “How do I distribute global key chains to NEs?”](#) (p. 281) .
- 3 _____
Verify the distribution of a global key chain to the NEs; see [10.47 “How do I verify the distribution of a global key chain to NEs?”](#) (p. 282) .
- 4 _____
Assign the key chain to a routing protocol, such as BGP or LDP.
- 5 _____
If required, identify the differences between a global and local policy or two local key chains; see [10.48 “How do I identify differences between a global and local key chain policy or two local key chains?”](#) (p. 283) .

10.45 How do I configure a global TCP key chain?

10.45.1 Steps

- 1 _____
Choose Administration→Security→TCP KeyChains from the NFM-P main menu. The TCP KeyChains form opens.
- 2 _____
Click Create or choose a key chain and click Properties. The KeyChain Create|Edit form opens.
- 3 _____
Configure the required parameters.
- 4 _____
Click on the KeyChain Key tab.
- 5 _____
Click Create or choose a key chain key and click Properties. The KeyChain Key Create|Edit form opens.
- 6 _____



CAUTION

Service Disruption

You must ensure bidirectional communication between NEs.

It is recommended that you choose the Send-receive option for the Key Direction parameter.

Configure the required parameters.

The End Time parameter is configurable only if the Key Direction parameter is set to Receive.

i **Note:** You must set the Begin Time parameter to a time after the beginning of the current UNIX epoch. Do not set the parameter to 1970/01/01 00:00(TZ=UTC) or earlier.

i **Note:** The NFM-P generates a random default value for the Key parameter. For greater security, it is recommended that you accept this value rather than manually enter a value. You cannot subsequently delete a TCP key chain or TCP key when the Admin State parameter for the key chain or key is set to In Service.

- 7 _____
Save and close the forms.

END OF STEPS _____

10.46 How do I distribute global key chains to NEs?

10.46.1 Purpose

Perform the following procedure to distribute one or more global TCP key chains to one or more NEs. When you distribute a global key chain, a local key chain using the Sync With Global distribution mode allows the NE to receive the key chain.



CAUTION

Service Disruption

Releasing, distributing, or deleting a TCP keychain or TCP key can be service-affecting.

Ensure that you understand the implications of these operations before you proceed.

10.46.2 Steps

1

Choose Administration→Security→TCP KeyChains from the NFM-P main menu. The TCP KeyChains form opens.

2

Verify that none of the key chains in the list that you want to distribute are in Draft configuration mode and go to [Step 4](#) . Otherwise go to [Step 3](#) .

3



WARNING

Equipment Damage

Verify the local definitions before releasing a global key chain.

When you release a global key chain, the key chain is distributed to existing local definitions.

When a key chain is in Draft configuration mode, the Distribute button is disabled and the key chain cannot be distributed to an NE. You must first release the key chain for distribution.

To release a key chain:

1. Select the key chain entry and click Properties. The Key Chain (Edit) form opens.
2. Click Switch Mode to acknowledge the Configuration Mode change. The Release form opens.
3. Select the required NEs for release by moving the appropriate row entries from the Available Objects panel to the Selected Objects panel.

See the policy management chapter in the *NSP NFM-P User Guide* for more information on policy distribution.

4. Click on the Distribute button to release the key chain locally to devices.

5. Click Close. The Release form closes and the configuration mode of the key chain is changed to Released.
6. Close the Key Chain (Edit) form.

4

To distribute a key chain:



Note: Local definitions of key chains that use the Local Edit Only distribution mode do not allow their NEs to receive the distribution of a global key chain. You must set the distribution mode of a local key chain to Sync With Global if you need the associated NE to receive the distribution of a global key chain.

1. Select one or more key chains and click Distribute. The Distribute - KeyChain form opens.
2. Select the required NEs by moving the appropriate row entries from the Available Objects panel to the Selected Objects panel.
3. Click Distribute. The NFM-P distributes the key chains to the NEs.
4. Close the Distribute - KeyChain form. The TCP KeyChains form reappears.

5

To configure the distribution mode of a local definition:

1. Click Switch Distribution Mode. The Switch Distribution Mode form opens.
2. Choose Sync With Global, Local Edit Only, or All from the drop-down menu. Only the sites that are configured with the selected distribution mode are listed.
3. Choose one or more entries in the Available Local Policies panel and click on the right arrow. The chosen entries move to the Selected Local Policies panel.
4. Depending on the current distribution mode of the chosen entries, perform one of the following:
 - Click Sync With Global.
 - Click Local Edit Only.The distribution mode of the selected entries changes accordingly.
5. Close the Distribution Mode form.

6

Close the TCP KeyChains form.

END OF STEPS

10.47 How do I verify the distribution of a global key chain to NEs?

10.47.1 Steps

1

Choose Administration→Security→TCP KeyChains from the NFM-P main menu. The TCP KeyChains form opens.

How do I identify differences between a global and local key chain policy or two local key chains?

- 2 _____
Select a key chain and click Properties. The KeyChain (Edit) form opens.
- 3 _____
Click on the Local Definitions tab. The NEs that have a local instance of the key chain are displayed in a list.
- 4 _____
View the list of NEs to confirm that the key chain is distributed to the required NEs.
- 5 _____
Close the forms.

END OF STEPS _____

10.48 How do I identify differences between a global and local key chain policy or two local key chains?

10.48.1 Steps

- 1 _____
Choose Administration→Security→TCP KeyChains from the NFM-P main menu. The TCP KeyChains form opens.
- 2 _____
Choose Local from the Policy scope menu to select a local NE. The Select a Network Element form opens.
- 3 _____
Select an NE and click OK. The NE IP address is displayed in the Local Node IP Address field.
- 4 _____
Choose the local key chain that you need to compare with another key chain and click Properties. The KeyChain (Edit) form opens.
- 5 _____
Click Local Audit On. The Local Audit form opens.



Note: You can cancel the local audit at any time by clicking Local Audit Off on the KeyChain (Edit) form.

The NFM-P does not identify differences between the Begin Time and End Time properties of key chains.

How do I identify differences between a global and local key chain policy or two local key chains?

6

Perform one of the following from the Policy scope menu:

- a. Choose Global and go to [Step 7](#).
- b. Choose Local to choose an NE. The Select a Network Element form opens.
 1. Select an NE and click OK. The NE IP address is displayed in the Local Node IP Address field.
 2. Go to [Step 7](#).

7

Click OK. The Local Audit form closes and the appropriate global|local policy opens for comparison.

8

View the differences between the key chains by clicking on the tabs that are highlighted with an arrow icon to indicate that differences exist on the forms. An arrow icon beside a property indicates that the property is modified. In lists, new entries are highlighted in pink and modified entries are highlighted in purple.

9

Close the forms.

END OF STEPS

Part III: NSP system administration

Overview

Purpose

This part of the *NSP System Administrator Guide* describes NSP system-level administration.

Contents

Chapter 11, NSP system configuration and management	287
Chapter 12, NSP cluster administration	305
Chapter 13, NSP cluster database administration	339
Chapter 14, NSP logging and monitoring	357
Chapter 15, NSP license administration	363

11 NSP system configuration and management

11.1 What is NSP system configuration and management?

11.1.1 Description

The procedures in this chapter describe global system administration operations that may occasionally be required.

11.2 How do I add an NSP feature package?

11.2.1 Purpose

Perform this procedure to add an NSP feature package to an existing NSP system.

11.2.2 Steps

- 1 _____
Submit an NSP Platform Sizing Request that includes the new feature package to Nokia.
- 2 _____
Adjust the physical and virtual resources of your deployment environment to meet or exceed the specifications in the response to your Platform Sizing Request.
- 3 _____
Submit a new NSP license request for the system that includes the new feature package.
You receive a license.zip file from Nokia.
- 4 _____
Perform [15.3 "How do I apply an NSP license?"](#) (p. 365).

END OF STEPS _____

11.3 How do I update the NSP system configuration?

11.3.1 Purpose

Perform this procedure to update one or more aspects of the NSP deployment; for example:

- Change a parameter value.
- Add an installation option.
- Remove an installation option.



CAUTION

Service Disruption

Performing the procedure requires a restart of each NSP cluster, which is service-affecting. During the restart, the NSP may be temporarily unavailable.

You must perform the procedure only during a scheduled maintenance period.

i **Note:** You must perform the procedure on each NSP cluster.

i **Note:** In a DR deployment, you must perform the steps first on the standby NSP cluster.

11.3.2 Steps

1

Log in as the root user on the NSP deployer host.

2

Open a console window.

3

If you intend to remove any installation options, perform the following steps.

i **Note:** If the NSP cluster VMs do not have the required SSH key, you must include the `--ask-pass` argument in the following command, as shown in the following example, and are subsequently prompted for the root password of each cluster member:

```
nspdeployerctl --ask-pass uninstall --undeploy
```

1. Open the following file using a plain-text editor such as `vi`:

```
/opt/nsp/NSP-CN-DEP-release-ID/NSP-CN-release-ID/config/nsp-config.yml
```

2. Edit the following line in the **platform** section, **kubernetes** subsection to read as shown below:

```
deleteOnUndeploy:false
```

3. Save and close the file.

4. Enter the following:

```
# /opt/nsp/NSP-CN-DEP-release-ID/bin/nspdeployerctl uninstall  
--undeploy ↵
```

The NSP cluster stops.

4

Open the following file using a plain-text editor such as `vi`:

```
/opt/nsp/NSP-CN-DEP-release-ID/NSP-CN-release-ID/config/nsp-config.yml
```

Add or remove installation options

5

Locate the **installationOptions** section in the **nsp** section, which resembles the following:

```
installationOptions:
  - name: "NSP Platform - Base Services"
    id: platform-baseServices
  - name: "NSP Platform - Logging and Monitoring"
    id: platform-loggingMonitoring
#   - name: "Other Installation Option"
#     id: otherInstallationOption
```

6

To add an installation option, uncomment the installation option name and id lines by removing the leading # character from each line.



Note: You must preserve the leading spaces in each line.

7

To remove an installation option, convert the installation option name and id lines to comments by inserting a # character at the beginning of each line.



Note: You must preserve the spaces that follow the # character.

Update parameters

8

To enable a parameter that is currently disabled, uncomment the parameter line by removing the leading # character.



Note: You must preserve the leading spaces in the line.

9

To disable a parameter that is currently enabled, comment out the parameter line by restoring the leading # character.



Note: You must preserve the leading spaces in the line.

10

Configure parameter values, as required.

Save and deploy updated configuration

11 _____
Save and close the nsp-config.yml file.

12 _____
Enter the following to start the NSP cluster:

i **Note:** If the NSP cluster VMs do not have the required SSH key, you must include the --ask-pass argument in the command, as shown in the following example, and are subsequently prompted for the root password of each cluster member:

```
nspdeployerctl --ask-pass install --config --deploy  
# /opt/nsp/NSP-CN-DEP-release-ID/bin/nspdeployerctl install --config  
--deploy ↵
```

The NSP cluster starts, and the configuration update is put into effect.

13 _____
Close the console window.

END OF STEPS _____

11.4 How do I change the nsp user password?

11.4.1 Purpose

Perform this procedure to change the password of the nsp user on a station in an NSP deployment.

11.4.2 Steps

1 _____
Log in to the component station as the root user.

2 _____
Open a console window.

3 _____
Enter the following:

```
# passwd nsp ↵
```

The following prompt is displayed:

```
New Password:
```

4 _____
Enter the new password and press ↵.

The following prompt is displayed:

Confirm New Password:

5

Enter the new password again and press ↵. The password is changed.

6

Record the new password and store it in a secure location.

7

Close the console window.

8

Log out of the component station.

END OF STEPS

11.5 How do I change the NSP cluster registry password?

11.5.1 Purpose

Perform this procedure to change the password of the NSP container registry administrator.



Note: The initial registry login attempt after the password change displays an error message that you can safely ignore.

11.5.2 Steps

1

Log in as the root user on the NSP deployer host.

2

Open a console window.

3

Enter the following:

```
# cd /opt/nsp/nsp-registry-release-ID/bin ↵
```

4

Enter the following:

```
# ./nspregistryctl update -p ↵
```

The following prompt is displayed.

Enter the current registry admin password:

-
- 5 _____
- Enter the current password.
- The following prompt is displayed:
- Enter the new registry admin password:
- 6 _____
- Create a new password; the password must:
- be a minimum of 10 characters
 - include at least one:
 - uppercase character
 - lowercase character
 - digit
 - special character in the following list:
! # \$ % & () * + , - . / : ; = ? @ \ ^ _ { | }
- 7 _____
- Enter the new password.
- The password is changed.
- 8 _____
- Record the new password and store it in a secure location.
- 9 _____
- Close the console window.
- END OF STEPS _____

11.6 How do I remove the stale NSP allowlist entries?

11.6.1 Purpose

After an NSP system upgrade, hostname entries in the NSP allowlist that the NSP cannot resolve to an IP address may prevent NSP access. The following steps describe how to check for and remove stale NSP allowlist entries.

 **Note:** You must perform the procedure in each data center of a DR NSP deployment.

11.6.2 Steps

- 1 _____
- Log in as the root user on the NSP cluster host.

2 _____
Open a console window.

3 _____
Enter the following:

```
# kubectl exec -n $(kubectl get pods -A | awk '/nspos-tomcat/ {print $1;exit}') -it nspos-tomcat-0 -c nspos-tomcat -- bash ↵
```

4 _____
Enter the following:

```
# grep "could not normalize or resolve host" /opt/nsp/os/tomcat/logs/LaunchPad.log | grep -v grep ↵
```

Any stale allowlist entries are listed.

5 _____
If the command returns any output lines like the following, the NSP allowlist includes hostname entries that you must remove; otherwise, go to [Step 13](#).

```
<timestamp> could not normalize or resolve host: hostname
```

Record the hostname in each output line.

6 _____
Enter the following to open a command shell on the PostgreSQL pod:

```
# kubectl exec -n $(kubectl get pods -A | awk '/nspos-postgresql-primary/ {print $1;exit}') --stdin --tty nspos-postgresql-primary-0 -- /bin/bash ↵
```

7 _____
Enter the following:

```
# cd /opt/nsp/os/pgsql/bin ↵
```

8 _____
Enter the following to log in to the PostgreSQL database:

```
# ./psql -U username password ↵
```

where *username* and *password* are the PostgreSQL credentials, which are available from technical support
A PostgreSQL prompt is displayed.

9 _____
Enter the following:

```
select * from whitelist.whitelistedhost; ↵
```

The hosts in the NSP allowlist are listed; the hostname is in the rightmost column.

-
- 10 _____
Record the dbid value of each hostname recorded in [Step 5](#).
- 11 _____
Enter the following to delete the unresolved hosts from the allowlist:

```
delete from whitelist.whitelistedhost where dbid in (host1_ID,host2_ID...hostn_ID); ↵
```

where *host1_ID* to *hostn_ID* is a comma-separated list of the IDs of the hosts to remove
The hosts are removed from the allowlist.
- 12 _____
Enter the following to log out of the PostgreSQL database:

```
quit ↵
```
- 13 _____
Close the console window.
- END OF STEPS _____

11.7 How do I disable NSP websocket event notifications?

11.7.1 Purpose

Websocket-based events are used by some NSP functions. The following steps describe how to disable websocket event notifications, if required.

i **Note:** The websocket connection used by the NSP may not function if a browser or any client is behind a proxy. Websocket communication through an entity between the websocket client and server, for example, a proxy server, firewall, or load balancer, is dependent on the entity configuration.

i **Note:** The following RHEL CLI prompts in command lines denote the active user, and are not to be included in typed commands:

- # —root user
- bash\$ —nsp user

11.7.2 Steps

- 1 _____
Log in as the nsp user on the IP resource control server.
- 2 _____
Open a console window.

3

Enter the following:

```
bash$ cd /opt/nsp/configure/config ↵
```

4

Open the wsc-security.conf file using a plain-text editor such as vi.

5

Modify the following section to read:

```
websocket {  
  enableEvents=false  
}
```

6

Enter the following to restart the web server:

i **Note:** If the NSP deployment is redundant, you must perform the step on each IP resource control server.

```
# systemctl restart nsp-tomcat ↵
```

The web server restarts, and websocket event notifications are disabled.

7

Close the console window.

END OF STEPS

11.8 How do I install custom Mistral actions for NSP Workflows?

11.8.1 Purpose

Perform this procedure to install custom Mistral actions created by Nokia Professional Services.

i **Note:** Installation of self-developed actions is currently restricted to lab use only.

Before you start, the zip file containing the custom actions must be saved in a directory accessible to the root user. The zip file must follow Python directory packaging rules. The subdirectories in the zip file must be called `actions` and `expressions`.

i **Note:** The Mistral pods must be restarted for the custom actions to be applied in NSP Workflows. The restart will affect NSP Workflows operation.

i **Note:** `release-ID` in a file path has the following format:
`R.r.p-rel.version`
where

R.r.p is the NSP release, in the form *MAJOR.minor.patch*
version is a numeric value

11.8.2 Steps

- 1 _____
Log in as the root user on the station where the NSP deployer host.
- 2 _____
Open a console window.
- 3 _____
Enter the following:

```
# cd /opt/nsp/NSP-CN-DEP-release-ID/NSP-CN-release-ID/tools/wfm/bin ↵
```
- 4 _____
Perform one of the following:
 - a. To copy the custom actions to the NSP without restarting the pods, enter the following:

```
# ./custom-actions.bash --install path ↵
```
 - b. To copy the custom actions to the NSP and restart the pods immediately, enter the following:

```
# ./custom-actions.bash --install path --restart ↵
```where *path* is the absolute path of the zip file that contains the custom actions to install
- 5 _____
To restart the Mistral pods, enter the following:

```
# ./custom-actions.bash --restart ↵
```
- 6 _____
Close the console window.

END OF STEPS _____

11.9 How do I remove Mistral actions from NSP?

11.9.1 Purpose

Perform this procedure to specify Mistral actions to drop, if required for network security. An action that is dropped cannot be called by a workflow. Dropping actions requires adding an environment variable to each Mistral engine in the NSP deployment.

You must perform the procedure on each NSP cluster in the deployment.

11.9.2 Steps

- 1 _____
Log in as the root user on the NSP cluster host.
- 2 _____
Open a console window.
- 3 _____
Open each of the following files for editing:
 - /opt/nsp/config/helm/values/wfm/nsp-mistral-engine/values.yaml
 - /opt/nsp/config/helm/values/wfm/nsp-mistral-engine-triggers/values.yaml
 - /opt/nsp/config/helm/values/lso/nsp-mistral-engine-lsom/values.yaml
- 4 _____
Enter the following in the **env** section of each file:

```
ACTIONS_DROP "action_1 action_2 . . . action_n"
```

where *action_1* to *action_n* are the actions to drop
- 5 _____
Obtain the engine name, namespace, chart name and chart version of each Mistral engine; enter the following:

```
# helm list -A ↵
```

Output like the following is displayed:

```
engine namespace 1 timestamp deployed chart_name-chart_version  
release
```
- 6 _____
Obtain the Helm repository name and URL; enter the following:

```
# helm repo list ↵
```

Output like the following is displayed:

```
NAME URL  
nokia-nsp repository URL
```
- 7 _____
Enter the following for each Mistral engine:

```
# helm upgrade engine -n namespace chart_name --version chart_version  
--repo repository URL -f path ↵
```

where
engine, *namespace*, *chart_name*, and *chart_version* are the values obtained in [Step 5](#)

repository and *URL* are the values obtained in [Step 6](#)

path is the path of the associated engine configuration file, and is one of:

- `/opt/nsp/config/helm/values/wfm/nsp-mistral-engine/values.yaml`
- `/opt/nsp/config/helm/values/wfm/nsp-mistral-engine-triggers/values.yaml`
- `/opt/nsp/config/helm/values/lso/nsp-mistral-engine-lsom/values.yaml`

The new environment variables are put in effect and the actions are unavailable to workflows.

8

Close the console window.

END OF STEPS

11.10 How do I configure a generic mediator?

11.10.1 Purpose

Use this procedure to install or uninstall a generic mediator to connect to an external controller. A generic mediator will handle authentication to the controller, allowing a call to be made to the controller from NSP without the need to provide credentials.

You can configure as many generic mediators as required, with different external controller parameters. The latest helm chart and docker images are contained in the nsp configurator tar package with the name "nsp-mdt-generic-mediator".

To provide generic mediator parameters to the NSP you must create a values.yaml file; see the Intent Based Management Framework tutorial on the [Network Developer Portal](#) for information.

Naming

Each generic mediator must have a unique name.

Names must be unique in the following areas:

- the name of the instance in Helm
You can allow Helm to autogenerate a unique name, however, using the `-n` option when installing the Helm chart will allow you to use a meaningful user identifiable name.
- the name of the pod and Kubernetes configuration
This is specified in the values.yaml file using the `mediator_name` value. When the name is given, the Kubernetes structures will be given a name like `nsp-mdt-<name>-mediator`. For example, to name the mediator SF1, enter the `mediator_name: "SF1"` in the values.yaml file. This will produce a pod and Kubernetes structures prefixed with `nsp-mdt-SF1-mediator`. If multiple words are in the name, they must be separated with a dash character (-).

The Helm instance name and the `mediator_name` do not have to be the same, however, using the same name may make alignment simpler.

Certs files

Certs files may need to be copied into the pod for requests and authentication to work properly. This is done by a combination of the `copy_certs` and `certsFileName` properties and the `--set-file` flag on the Helm command.

When `copy_certs` is set to `true`, the NSP will attempt to copy a certs file into the pod in the `/opt/nsp/os/ssl/certs/custom` directory. Since the name of the certs file might be important and the mediator itself will not be aware of this, the file name to give this file is specified in the `certsFileName` value.

For example, if you have these values in the `values.yaml` file:

- `copy_certs: true`
- `certsFileName: "ca.pem"`

A file named `ca.pem` is created in the `/opt/nsp/os/ssl/certs/custom` directory.

If you specify `copy_certs: true` in the `values.yaml` file but do not add the `--set-file` flag to the Helm command, the pod will not initialize.

11.10.2 Steps

Perform Helm installation

1

Log in as the root user on the NSP cluster host.

2

Open a console window.

3

Execute the Helm installation based on the following example:

```
# helm install nokia-nsp/nsp-mdt-generic-mediator -n  
nsp-mdt-name-mediator -f values file --set-file  
externalControllerConfig.externalControllerAuth.certsFile=certs file ↵
```

where

name is the name for the mediator

values file is the path to the `values.yaml` file

certs file is the path to the certs file

If you do not want to copy certs files to the pod, the `--set-file` flag is not required.

Perform Helm uninstallation

4

To uninstall a generic mediator, you must delete them using Helm. Execute the following:

```
# helm uninstall mediator-instance-name --namespace namespace -n  
$(kubectl get pods -A | awk '/mediator-instance-name/ {print$1;exit}')  
↵
```

where

mediator instance name is the mediator instance, for example, nsp-mdt-generic-mediator

namespace is the Kubernetes namespace

5

Close the console window.

END OF STEPS

11.11 How do I configure an NSP Workflows trigger framework?

11.11.1 Purpose

Use this procedure to install or uninstall a WFM framework. The WFM Trigger framework enables you to trigger workflows from an external system such as Git or HTTPS, without the need for NSP Workflows to monitor the external system directly.

The framework provided by NSP installs a single microservice that can handle at least one user-provided plugin installed into that microservice. The framework handles connections to the internal Kubernetes environment and to NSP Workflows, while the plug-in connects to the external system. The plugin must include a specified Python file to allow it to push to a Kafka topic in the NSP. From there, a Kafka Trigger can be created in NSP Workflows to trigger a workflow.

You can configure as many microservices as required, with different parameters. container images and Helm charts are provided in the Nokia Git repository.

This procedure provides general information. See the WFM Trigger Framework tutorial on the [Network Developer Portal](#) for more details.

Container image

You will need to use a container image generated from the base container image provided by NSP, that includes the code written to handle the external system. The name of the base image can be found either by browsing the NSP container repository or by looking at the provided defaulted values.yaml file.

Helm charts

A default values.yaml file is provided, and new values.yaml files must be derived from this one to get all the appropriate NSP-specific information that the pod needs to run. You need to change the following values:

- `pod_name`: Each pod must be given a unique pod name to avoid clashes over resources and so to install properly.
- `topic_name`: This specifies the topic name that messages will be sent on (and thus that the Kafka Trigger must listen on). The topic will always be `wfm.trigger.<topic_name>`. If this is not given, the `pod_name` will be used as the topic name.

- `pluginConfigFileName`: The file name of any config file that the user happens to be using. If this is not set, it defaults to `plugin.conf`.
- `pluginConfigFileInstallPath`: The install path of the config file. If this is not set, it defaults to `/opt/nsp/configure/config`.
- `pluginPythonClientFile`: The name and path of the client file that's importing the `framework_server_client`. If this is not set, it defaults to `/opt/nsp/launch_python_app.py`.
- `pluginCertsFileName`: The file name for any certs that are being used. If this is not set, it defaults to `plugincert.pem`.
- `pluginCertsInstallPath`: The install path for any certs that are being used. If this is not set, it defaults to `/opt/nsp`.

11.11.2 Steps

Perform Helm installation

1 _____

Log in as the root user on the NSP cluster host.

2 _____

Open a console window.

3 _____

Execute the Helm installation based on the following example:

```
# helm install Helm_name Helm_path-f values_file --set-file  
pluginCertsFile= certs_file --set-file pluginConfigFile=plugin_file ↵
```

where

Helm_name is the identifier of the Helm_chart

Helm_path is path to the Helm chart

values_file is the path to the values.yaml file

certs_file is the path to and filename of the certs file

plugin_file is the path to and filename of the plugin file

If you do not want to copy certs files to the pod, the `--set-file pluginCertsFile` flag is not required.

Perform Helm uninstallation

4 _____

To uninstall a framework, you must delete them using Helm. Execute the following:

```
# helm uninstall Helm_name --namespace namespace -n $(kubectl get pods  
-A | awk '/Helm_name/ {print$1;exit}') ↵
```

where

Helm_name is the framework Helm chart identifier
namespace is the Kubernetes namespace

- 5 _____
Close the console window.

END OF STEPS _____

11.12 How do I manage NSP Analytics logging?

11.12.1 Purpose

The following steps describe how to enable, configure, and disable the logging of Analytics events for troubleshooting purposes.

By default, NSP Analytics logs only error events.



CAUTION

Excessive Resource Consumption Risk

Performing the procedure restarts NSP Analytics. Also, the logging may consume excessive disk space if logging is enabled for an extended period.

Perform the procedure only if required, and only for the period required to collect the log entries of interest. Contact technical support for assistance or more information.

i **Note:** The following RHEL CLI prompt in a command line denotes the nsp user, and is not to be included in a typed command:

- bash\$

11.12.2 Steps

- 1 _____
Sign in to the NSP as an administrator.
- 2 _____
Open Data Collection and Analysis Management, Analytics Server Management.
- 3 _____
Click Logging Configuration on the navigation panel.

4



CAUTION

Performance Degradation Risk

Enabling an NSP Analytics logging level other than the default, especially using the All option, or the auditing option in [Step 6](#), may cause performance degradation as a result of excessive resource consumption.

Ensure that you enable a non-default logging option only as and when directed by technical support, and that the logging level is reset to the default afterward.

Use the **Server log level** drop-down list to set the log level, which is one of the following:

- Default—error logging only
- All—error, ad-hoc, and database transaction logging
- Ad Hoc—ad-hoc report logging
- SQL—database transaction logging only

5

To reset the server logging level to the default, click the **Reset** button beside the **Server log level** drop-down.

6

Only as directed by technical support, use the **Auditing logs** drop-down to enable audit logging that includes all log levels, for example, information, warning, and error.



Note: It is strongly recommended that audit logging is not enabled for an extended period; contact technical support before you enable the option.

7

To disable audit logging level, use the **Auditing logs** drop-down, or click the **Reset** button beside the drop-down.

END OF STEPS

11.13 How do I configure e-mail notification of scheduled Analytics reports?

11.13.1 Steps

1

Sign in to the NSP as an administrator.

2 _____
Open Data Collection and Analysis Management, Analytics Server Management.

3 _____
Click **E-mail Server Configuration** on the navigation panel.

4 _____
Perform one of the following:

- a. If you want to use the parameter values configured for your NSP user account, click **IMPORT NSP SETTINGS**.
The parameters are updated to match your NSP user e-mail settings.
- b. Configure the parameters listed in the following table.

| Parameters | Notes |
|-----------------------|---|
| E-mail server address | IPv4 address, hostname, or FQDN of e-mail server
An e-mail server with an IPv6 address must use a hostname or FQDN.
A hostname or FQDN must be resolvable by DNS. |
| Protocol | E-mail authentication protocol |
| Port number | TCP listening port on e-mail server |
| From e-mail address | Sending e-mail address of e-mail notifications |
| Username and Password | Authentication credentials for e-mail server |

5 _____
Click **UPDATE** to save the changes.

END OF STEPS _____

12 NSP cluster administration

NSP cluster control and operation

12.1 How do I manage NSP clusters?

12.1.1 NSP cluster startup and shutdown

Low-level routine maintenance such as applying a RHEL OS patch to the hosts in an NSP Kubernetes cluster may require that you stop and start Kubernetes in the cluster.

Stopping Kubernetes in an NSP cluster stops the NSP software in the cluster, and creates a network management outage in a standalone deployment.

In a DR deployment, you can avoid a network management outage by stopping and starting the clusters in sequence, as specified in [12.2 “Workflow: stop and start DR NSP clusters” \(p. 306\)](#).

12.1.2 Description

The following procedures describe the following basic Kubernetes administration operations for the NSP:

- starting and stopping clusters
- identifying the master node in a cluster
- displaying the DR status
- performing DR role switches

12.1.3 NSP infrastructure health monitoring

The NSP has internal agents that monitor the NSP deployment infrastructure. An alarm is raised in response to the detection of one of the following NSP deployer host fault conditions:

i **Note:** An NSP deployer host unreachability alarm clears automatically when reachability is restored.

- NSP deployer host unreachability
- Harbor registry unavailability
- excessive disk consumption

12.2 Workflow: stop and start DR NSP clusters

12.2.1 Description



CAUTION

System Degradation

If the primary NSP cluster and associated primary components outside the cluster are not in the same data center, the maintenance shutdown described in this workflow may cause an undesired DR switchover of one or more components, which can be service-affecting.

Before you attempt to use this workflow, you must ensure that the primary NSP cluster and associated primary components outside the cluster are in the same data center. If not, perform the appropriate procedure to ensure that all component roles in each data center are aligned.

The following is the sequence of high-level actions required to stop and start the primary and standby NSP clusters in a graceful manner for maintenance purposes.

See the following procedures for information about stopping and starting a cluster:

- [12.3 “How do I stop an NSP cluster?”](#) (p. 309)
- [12.4 “How do I start an NSP cluster?”](#) (p. 311)

12.2.2 Stages

Perform orderly shutdown of standby components outside NSP cluster

1

If the NSP deployment includes NSP Flow Collectors:

1. Stop each Flow Collector in the standby data center, as described in [19.8 “How do I start or stop an NSP Flow Collector?”](#) (p. 440).
2. Stop each Flow Collector Controller in the standby data center, as described in [19.3 “How do I start or stop an NSP Flow Collector Controller?”](#) (p. 436).

2

If the NSP deployment includes an auxiliary database, stop the auxiliary database cluster in the standby data center, as described in [20.3 “How do I stop an auxiliary database cluster?”](#) (p. 453).

3

If the NSP deployment includes the NFM-P, perform the following steps.

1. Stop each Reserved NFM-P auxiliary server of the standby main server; see [21.7 “How do I stop an auxiliary server?”](#) (p. 519).
2. Stop each Preferred NFM-P auxiliary server of the standby main server; see [21.7 “How do I stop an auxiliary server?”](#) (p. 519).
3. Stop the standby main server; see [21.3 “How do I stop a main server?”](#) (p. 516).

-
4. Stop the standby main database; see [21.5 “How do I stop a main database?”](#) (p. 518).

Perform standby NSP cluster maintenance

4

Stop the standby NSP cluster, as described in [12.3 “How do I stop an NSP cluster?”](#) (p. 309).

5

Perform the required maintenance on the standby cluster.

6

Start the standby cluster, as described in [12.4 “How do I start an NSP cluster?”](#) (p. 311).

Switch NSP cluster roles

7

Perform an activity switch to change the standby cluster role to primary, as described in [16.4 “How do I perform an NSP DR switchover?”](#) (p. 373).

The standby cluster assumes the primary role.

Perform orderly startup of standby components outside cluster

8

If the NSP deployment includes the NFM-P, perform the following steps.

1. Start the former standby main database; see [21.4 “How do I start a main database?”](#) (p. 517).
2. Start the former standby main server; see [21.2 “How do I start a main server?”](#) (p. 515).
3. Start each Preferred NFM-P auxiliary server of the former standby main server; see [21.6 “How do I start an auxiliary server?”](#) (p. 518).
4. Start each Reserved NFM-P auxiliary server of the former standby main server; see [21.6 “How do I start an auxiliary server?”](#) (p. 518).

9

If the NSP deployment includes an auxiliary database, start the auxiliary database cluster in the former standby data center; see [20.2 “How do I start an auxiliary database cluster?”](#) (p. 453).

10

If the NSP deployment includes NSP Flow Collectors:

1. Start each Flow Collector Controller in the former standby data center, as described in [19.3 “How do I start or stop an NSP Flow Collector Controller?”](#) (p. 436).
2. Start each Flow Collector in the standby data center, as described in [19.8 “How do I start or stop an NSP Flow Collector?”](#) (p. 440).

Perform orderly shutdown of former primary components outside NSP cluster

11

If the NSP deployment includes the NFM-P, perform the following steps.

1. Stop each Preferred NFM-P auxiliary server of the former primary main server; see [21.7 “How do I stop an auxiliary server?”](#) (p. 519).
2. Stop each Reserved NFM-P auxiliary server of the former primary main server; see [21.7 “How do I stop an auxiliary server?”](#) (p. 519).
3. Stop the former primary main server; see [21.3 “How do I stop a main server?”](#) (p. 516).
4. Stop the former primary main database; see [21.5 “How do I stop a main database?”](#) (p. 518).

12

If the NSP deployment includes NSP Flow Collectors:

1. Start each Flow Collector Controller in the standby data center, as described in [19.3 “How do I start or stop an NSP Flow Collector Controller?”](#) (p. 436).
2. Start each Flow Collector in the standby data center, as described in [19.8 “How do I start or stop an NSP Flow Collector?”](#) (p. 440).

Perform former primary NSP cluster maintenance

13

Stop the former primary cluster, as described in [12.3 “How do I stop an NSP cluster?”](#) (p. 309).

14

Perform the required maintenance on the former primary cluster.

15

Start the former primary cluster, as described in [12.4 “How do I start an NSP cluster?”](#) (p. 311).

Perform orderly startup of former primary components outside cluster

16

If the NSP deployment includes the NFM-P, perform the following steps.

1. Start the former primary main database; see [21.4 “How do I start a main database?”](#) (p. 517).
2. Start the former primary main server; see [21.2 “How do I start a main server?”](#) (p. 515).
3. Start each Preferred NFM-P auxiliary server of the former primary main server; see [21.6 “How do I start an auxiliary server?”](#) (p. 518).
4. Start each Reserved NFM-P auxiliary server of the former primary main server; see [21.6 “How do I start an auxiliary server?”](#) (p. 518).

17

If the NSP deployment includes an auxiliary database, start the auxiliary database cluster in the former primary data center; see [20.2 “How do I start an auxiliary database cluster?”](#) (p. 453).

18

If the NSP deployment includes NSP Flow Collectors:

1. Start each Flow Collector Controller in the former primary data center, as described in [19.3 “How do I start or stop an NSP Flow Collector Controller?”](#) (p. 436).
2. Start each Flow Collector in the primary data center, as described in [19.8 “How do I start or stop an NSP Flow Collector?”](#) (p. 440).

Restore initial primary/standby NSP cluster roles

19

If required, perform an activity switch to restore the initial primary and standby roles, as described in [16.4 “How do I perform an NSP DR switchover?”](#) (p. 373).

12.3 How do I stop an NSP cluster?

12.3.1 Purpose



CAUTION

Network Management Disruption or Outage

Performing the procedure in a standalone deployment completely stops the NSP and creates a network management outage that persists until you start the cluster. In a DR deployment, stopping an NSP cluster may initiate a server activity switch that may temporarily affect network management.

Perform the procedure only during a scheduled maintenance period and under the guidance of technical support.

The following steps describe how to stop the Kubernetes software in an NSP cluster, for example, when the NSP hosts in the cluster require maintenance, or for cluster decommissioning.

i **Note:** If you are stopping the NSP clusters in a DR deployment, ensure that you perform the procedure at the appropriate stage of [12.2 “Workflow: stop and start DR NSP clusters”](#) (p. 306).

i **Note:** A leading # character in a command line represents the root user prompt, and is not to be included in a typed command.

i **Note:** *release-ID* in a file path has the following format:
R.r.p-rel.version
where
R.r.p is the NSP release, in the form *MAJOR.minor.patch*

version is a numeric value

12.3.2 Steps

1 _____

Log in as the root user on the NSP deployer host.

2 _____

Open a console window.

3 _____

Open the following file using a plain-text editor such as vi:

`/opt/nsp/NSP-CN-DEP-release-ID/NSP-CN-release-ID/config/nsp-config.yml`

4 _____

Edit the following line in the **platform** section, **kubernetes** subsection to read as shown below:

```
deleteOnUndeploy:false
```

5 _____

Save and close the file.

6 _____

Enter the following:



Note: If the NSP cluster VMs do not have the required SSH key, you must include the `--ask-pass` argument in the command, as shown in the following example, and are subsequently prompted for the root password of each cluster member:

```
nspdeployerctl --ask-pass uninstall --undeploy
```

```
# /opt/nsp/NSP-CN-DEP-release-ID/bin/nspdeployerctl uninstall  
--undeploy ↵
```

The NSP cluster stops.

7 _____

Log in as the root user on the NSP cluster host.

8 _____

Open a console window.

9 _____

Enter the following periodically to display the Kubernetes cluster status:

```
# kubectl get pods -A ↵
```

The NSP cluster is stopped when only the following output is displayed:

| NAME | READY | STATUS | RESTARTS | AGE |
|----------------------|-------|---------|----------|-----|
| nsp-backup-storage-0 | 1/1 | Running | 0 | age |

10

When the NSP cluster is stopped, close the console window.

END OF STEPS

12.4 How do I start an NSP cluster?

12.4.1 Purpose

The following steps describe how to start the Kubernetes software in an NSP cluster.

i **Note:** A leading # character in a command line represents the root user prompt, and is not to be included in a typed command.

12.4.2 Steps

1

Log in as the root user on the NSP deployer host.

2

Open a console window.

3

Enter the following:

i **Note:** If the NSP cluster VMs do not have the required SSH key, you must include the `--ask-pass` argument in the command, as shown in the following example, and are subsequently prompted for the root password of each cluster member:

```
nspdeployerctl --ask-pass install --deploy  
# /opt/nsp/NSP-CN-DEP-release-ID/bin/nspdeployerctl install --deploy ↵
```

The NSP cluster starts.

4

Log in as the root user on the NSP cluster host.

5

Open a console window.

6

Enter the following periodically to display the Kubernetes cluster status:

```
# kubectl get pods -A ↵
```

The NSP is operational when the status of each pod is Running or Completed.

7

When the NSP cluster is operational, close the console window.

END OF STEPS

12.5 How do I identify the master node in an NSP cluster?

12.5.1 Purpose

The following steps describe how to list the NSP cluster VMs and identify which has the master role.



Note: A leading # character in a command line represents the root user prompt, and is not to be included in a typed command.

12.5.2 Steps

1

Log in as the root user on the NSP cluster host.

2

Open a console window.

3

Enter the following:

```
# kubectl get nodes -o wide ↵
```

A list of VMs like the following is displayed.

| NAME | STATUS | ROLES | AGE | VERSION | INTERNAL-IP | EXTERNAL-IP |
|-------|--------|--------|-----|---------|-------------|-------------|
| node1 | Ready | master | nd | version | int_IP | ext_IP |
| node2 | Ready | <none> | nd | version | int_IP | ext_IP |
| node3 | Ready | <none> | nd | version | int_IP | ext_IP |

4

View the ROLES entries to identify the master node.

5

Close the console window.

END OF STEPS

12.6 How do I display the NSP cluster status?

12.6.1 Purpose

The following steps describe how to view the status of standalone or redundant NSP clusters.

- i** **Note:** You require root user privileges on each NSP cluster VM in each data center.
- i** **Note:** A leading # character in a command line represents the root user prompt, and is not to be included in a typed command.

12.6.2 Steps

1 _____
Log in as the root user on any NSP cluster VM.

2 _____
Open a console window.

3 _____
In a standalone deployment, enter the following:

```
# kubectl exec -n $(kubectl get pods -A | awk '/nsp-role-manager/{print $1;exit}') -it $(kubectl get pods -A | awk '/nsp-role-manager/{print $2;exit}') -c role-manager -- /opt/nsp/os/rolemgr/bin/rmgrctl status ↵
```

Cluster status output like the following is displayed:

```
Site: cluster_name  
Status: active  
Since: timestamp
```

4 _____
In a DR deployment, enter the following:

```
# kubectl exec -n $(kubectl get pods -A | awk '/nsp-role-manager/{print $1;exit}') -it $(kubectl get pods -A | awk '/nsp-role-manager/{print $2;exit}') -c role-manager -- /opt/nsp/os/rolemgr/bin/rmgrctl statusAll ↵
```

Cluster status output like the following is displayed:

```
Site: primary_cluster_name  
Status: active  
Since: timestamp  
Site: standby_cluster_name  
Status: standby  
Since: timestamp
```

5

Close the console window.

END OF STEPS

12.7 How do I restart a Kubernetes pod?

12.7.1 Purpose

Perform this procedure to restart a Kubernetes pod in an NSP cluster; for example, as directed by technical support during a maintenance operation.

12.7.2 Steps

1

Log in as the root user on the NSP cluster host.

2

Open a console window.

3

Enter the following to list the pod that you need to restart:

```
# kubectl get pods -A | grep string ↵
```

where *string* is part of the pod name

The pod instance names that include *string* are listed.

4

Enter the following:

```
# kubectl delete pod pod_name -n $(kubectl get pods -A | awk  
'/pod_name/ {print $1;exit}')
```

 ↵

where *pod_name* is the name of the pod to restart

The pod is deleted and recreated.

5

Close the console window.

END OF STEPS

12.8 How do I delete Errored or Evicted pods?

12.8.1 Purpose

In situations such as the following, one or more NSP pods may enter the Errored or Evicted state. The NSP raises an alarm against each such pod, and a CLI query displays them, as shown below:

```
namespace    pod_a      1/1      Running    0      18m
namespace    pod_b      1/1      Errored    0      18m
namespace    pod_c      0/1      Evicted    0      19m
```

An Errored pod is typically the result of an unplanned VM reboot.

A pod is typically Evicted because of insufficient storage space on the host node, which is often called disk pressure.

In either case, the Kubernetes orchestrator reschedules the pod to a different node in the NSP cluster.

Each Errored or Evicted pod is preserved for forensic analysis, but consumes no host resources. When the investigation of the pod failure is complete, you can safely delete the preserved pod.

Perform the following procedure to delete all Errored or Evicted pods in an NSP cluster.

12.8.2 Steps

- 1 _____
Log in as the root user on the NSP cluster host.
- 2 _____
Open a console window.
- 3 _____
Enter the following to list the pods in the NSP cluster.

```
# kubectl get pods -A ↵
```

The pods are listed.
- 4 _____
Enter the following:

```
# kubectl get pods -A | awk '$4 ~ /Evicted|Error/{print $1, $2}' |
xargs -n 2 kubectl delete pod -n ↵
```

Each Errored or Evicted pod is deleted.
- 5 _____
Enter the following:

```
# kubectl get pods -A ↵
```

The pods are listed.

6

Verify that no Errored or Evicted pods remain in the cluster.

7

Close the console window.

END OF STEPS

NSP cluster lifecycle management

12.9 What is Kubernetes cluster lifecycle management?

12.9.1 Description

The following procedures describe NSP Kubernetes cluster lifecycle management operations that may occasionally be required, such as:

- moving a pod to a different cluster node
- adding, removing, and replacing cluster nodes
- backing up and restoring the NSP deployer host configuration

12.10 How do I move a Kubernetes pod to a different node?

12.10.1 Purpose

The following steps describe how to move a non-pinned Kubernetes pod to a different node in an NSP cluster. This action may be required, for example, when you need to allocate additional node capacity to a pod that is pinned to a specific node.

 **Note:** You can only move pods that are not pinned to a specific node using labels.

12.10.2 Steps



CAUTION

System Degradation

The procedure includes operations that fundamentally reconfigure the NSP system.

You must contact Nokia support for guidance before you attempt to perform the procedure.

1 _____

Log in as the root user on the NSP cluster host.

2 _____

Open a console window.

3 _____

Enter the following:

```
# kubectl get pods -A -o wide ↵
```

The pods are listed.

4 _____

Enter the following to list all nodes:

```
# kubectl get nodes ↵
```

5

Enter the following:

```
# kubectl describe nodes node ↵
```

where *node* is the name of the node that has the pod to move

The node resources are listed.

6

Record the Memory Requests and CPU Requests values.

7

List the nodes to ensure that another node has sufficient capacity for the pod to move:

```
# kubectl describe nodes ↵
```

The nodes are listed.

8

View the Allocated resources value for each node to ensure that sufficient capacity exists according to the Requests value.

9

Enter the following to cordon the node that the pod is currently running on in order to prevent new pods from being scheduled on the node:

```
# kubectl cordon node ↵
```

where *node* is the name of the node to cordon

 **Note:** Existing pods on the node continue to run and are unaffected.

10

Restart the pod you intend to move.

1. Enter the following:

```
# kubectl get deployments -A ↵
```

The pods are listed.

2. Enter the following to stop the pod:

```
# kubectl scale deployment pod -n $(kubectl get pods -A | awk  
'/pod/ {print$1;exit}')
```

where *pod* is the pod name

3. Enter the following to start the pod:

```
# kubectl scale deployment pod -n $(kubectl get pods -A | awk  
'/pod/ {print$1;exit}')
```

The pod is scheduled on a different node.

11

Verify that the pod is successfully moved to another node; enter the following:

```
# kubectl get pods -A -o wide ↵
```

The pods are listed.

12

Uncordon the node; enter the following:

```
# kubectl uncordon node ↵
```

where *node* is the node name

The node enters the Initializing state, and then moves to the "Running" state.

13

If the pod remains in the Pending state, no other node may have sufficient resources to host the pod; enter the following:

```
# kubectl describe pod pod_name -n $(kubectl get pods -A | awk  
'/<pod_name>/ {print$1;exit}') ↵
```

Information about why the pod remains in the Pending state is displayed:

14

Close the console window.

END OF STEPS

12.11 How do I add an NSP cluster node?

12.11.1 Purpose

The following steps describe how to add a node to an NSP cluster.

The procedure creates a new worker node in the cluster that can run pods that do not require local storage, such as pods that are not pinned to a specific node.

i **Note:** If root access for remote operations is disabled in the NSP configuration, remote operations such as SSH and SCP as the root user are not permitted within an NSP cluster. Steps that describe such an operation as the root user must be performed as the designated non-root user with sudoer privileges.

For simplicity, such steps describe only root-user access.

12.11.2 Steps



CAUTION

System Degradation

The procedure includes operations that fundamentally reconfigure the NSP system.

You must contact Nokia support for guidance before you attempt to perform the procedure.

1 _____

Log in as the root user on the NSP deployer host.

2 _____

Open a console window.

3 _____

Open the following file using a plain-text editor such as vi:

```
/opt/nsp/nsp-k8s-deployer-release-ID/config/k8s-deployer.yml
```

4 _____

Add the new node to the **hosts** section, as shown below; see the descriptive text at the head of the file for parameter information.

```
nodeName: node5  
nodeIp: 192.168.98.196  
accessIp: 203.0.113.5
```

5 _____

Save and close the file.

6 _____

Create a backup copy of the updated k8s-deployer.yml file, and transfer the backup copy to a station that is separate from the NSP system and preferably in a remote facility.



Note: The backup file is crucial in the event of an NSP deployer host failure, so must be available from a separate station.

7 _____

Enter the following:

```
# cd /opt/nsp/nsp-k8s-deployer-release-ID/bin ↵
```

8 _____

Enter the following to create the cluster configuration:

```
# ./nspk8sctl config -c ↵
```

The following is displayed when the creation is complete:

✓ Cluster hosts configuration is created at: `/opt/nsp/nsp-k8s-deployer-release-ID/config/hosts.yml`

9

Generate an SSH key for password-free NSP deployer host access to the new NSP cluster VM.

1. If remote root access is disabled, switch to the designated root-equivalent user.
2. Enter the following:

```
# ssh-keygen -N "" -f path -t rsa ↵
```

where *path* is the SSH key path, for example, `/home/user/.ssh/id_rsa`

3. Enter the following to distribute the key to the new VM.

```
# ssh-copy-id -i key_file user@address ↵
```

where

key_file is the SSH key file, for example, `/home/user/.ssh/id_rsa.pub`

address is the IP address of the new VM

user is the designated NSP ansible user, if root-user access is restricted; otherwise, *user@* is not required

The SSH key is transferred to the new node.

4. If remote root access is disabled, switch back to the root user.

10

Log in as the root user on the new VM.

11

Open a console window.

12

Enter the following:

```
# mkdir -p /opt/nsp/volumes/fluentd-posfiles ↵
```

13

Enter the following:

```
# chown -R 1000:1000 /opt/nsp/volumes ↵
```

14

Close the VM console window.

15

Enter the following on the NSP deployer host:

i **Note:** If the NSP cluster VMs do not have the required SSH key, you must include the `--ask-pass` argument in the command, as shown in the following example, and are subsequently prompted for the root password of each cluster member:

```
nspk8sctl --ask-pass install
```

```
# ./nspk8sctl install ↵
```

The updated NSP cluster is deployed.

16

Log in as the root user on the NSP cluster host.

17

Enter the following to verify that the new node is added to the cluster:

```
# kubectl get nodes ↵
```

An action such as the following causes pod deployment on the new node:

- moving a pod to the node, as described in [12.10 “How do I move a Kubernetes pod to a different node?”](#) (p. 317)
- enabling additional NSP features that do not require local storage, as described in the NSP Installation and Upgrade Guide

18

Back up the NSP cluster data, as described in [13.4 “How do I back up the NSP cluster databases?”](#) (p. 343)

19

Close the open console windows.

END OF STEPS

12.12 How do I remove an NSP cluster node?

12.12.1 Purpose

The following steps describe how to remove a node from an NSP cluster.

i **Note:** You can use the procedure to remove only a node added using procedure [12.11 “How do I add an NSP cluster node?”](#) (p. 319).

12.12.2 Steps



CAUTION

System Degradation

The procedure includes operations that fundamentally reconfigure the NSP system.

You must contact Nokia support for guidance before you attempt to perform the procedure.

1 _____

Log in as the root user on the NSP cluster host.

2 _____

Open a console window.

3 _____

Enter the following:

```
# kubectl get nodes ↵
```

The NSP cluster nodes are listed.

4 _____

Record the name of the node that you intend to remove.

5 _____

Enter the following to stop all pods that are running on the node:

```
# kubectl drain node --ignore-daemonsets --delete-local-data ↵
```

where *node* is the name of the node that you intend to remove

6 _____

Enter the following:

```
# kubectl delete node name ↵
```

where *name* is the name of the node to remove

The node is removed from the cluster.

7 _____

Enter the following:

```
# kubectl get nodes ↵
```

The NSP cluster nodes are listed.

8 _____

Verify that the node is removed from the cluster.

9

Log in as the root user on the NSP deployer host.

10

Open the following file using a plain-text editor such as vi:
`/opt/nsp/nsp-k8s-deployer-release-ID/config/k8s-deployer.yml`

11

Remove all references to the removed node to ensure that the node cannot be added back into the cluster during a redeployment operation.

12

Save and close the file.

13

Create a backup copy of the updated `k8s-deployer.yml` file, and transfer the backup copy to a station that is separate from the NSP system, preferably in a remote facility.

14

Enter the following:

```
# cd /opt/nsp/nsp-k8s-deployer-release-ID/bin ↵
```

15

Enter the following to create the cluster configuration:

```
# ./nspk8sctl config -c ↵
```

The following is displayed when the creation is complete:

```
✓ Cluster hosts configuration is created at:  
/opt/nsp/nsp-k8s-deployer-Release-ID/config/hosts.yml
```

16

Perform [13.4 “How do I back up the NSP cluster databases?” \(p. 343\)](#) to ensure that the reconfigured cluster can be restored in the event of a failure.

17

Close the console window.

END OF STEPS

12.13 How do I change NSP system addressing?

12.13.1 Purpose



CAUTION

Service Disruption

Changing an IP address or hostname in an NSP system is a complex operation that requires careful planning and organization, and may require a complete system redeployment.

Do not attempt to modify the network configuration of an NSP component without assistance from NSP professional services.

Changing the addressing of the NSP deployer host or NSP cluster members may be required, for example, when the management network topology changes.

The requirements of such an operation depend on the management network topology and other considerations, so must be planned, co-ordinated, and performed only under the guidance of technical support.



Note: In-service hostname modification on an NSP deployer host or NSP cluster member is not possible. Such a modification requires a complete system reinstallation, and a reimport of the Helm charts and container images. Contact NSP technical support for more information.

12.13.2 Steps

1

Collect the following information:

- each NSP deployer host, NSP cluster, and ancillary component hostname
- each NSP deployer host, NSP cluster, and ancillary component IP address
- configuration information for mechanisms in the management network that affect addressing, such as NAT
- each proposed new IP address or hostname

2

Contact NSP professional services to plan and schedule a maintenance period for the addressing change.

END OF STEPS

12.14 How do I back up the NSP deployer host?

12.14.1 Purpose

Perform the following steps to back up the NSP deployer host in an NSP cluster. An NSP deployer host backup is crucial for the recovery of the NSP deployer host in the event of a failure.

i **Note:** The steps describe how to back up an NSP deployer host in a KVM virtualization environment; for OpenStack or VMware ESXi, see the RHEL or VMware documentation for information about how to restore a VM.

12.14.2 Steps

1 _____
Log in as the root user on the station that hosts the NSP deployer host VM.

2 _____
Open a console window.

3 _____
Enter the following to stop the VM:
`# virsh destroy VM ↵`
where *VM* is the VM name

4 _____
Enter the following to convert the NSP deployer host VM image in qcow2 format to conserve disk space:
`# qemu-img convert -f raw -O qcow2 sparse_current_image raw_backup_image.qcow2 ↵`
where
sparse_current_image is the name of the current VM image in sparse format
raw_backup_image is the name to assign to the backup VM image in raw format

5 _____
Enter the following to start the VM:
`# virsh start VM ↵`
where *VM* is the VM name
The VM starts.

6 _____
Store the *raw_backup_image.qcow2* file in a location separate from the NSP system and preferably in a remote facility.

7 _____
Close the open console windows.

END OF STEPS _____

12.15 How do I restore the NSP deployer host?

12.15.1 Purpose

The following steps describe how to restore the NSP deployer host in an NSP cluster, for example, if the deployer host VM fails and must be recreated.

i **Note:** The steps describe how to restore an NSP deployer host in a KVM virtualization environment; for OpenStack or VMware ESXi, see the RHEL or VMware documentation for information about how to restore a VM.

i **Note:** In order to perform the procedure, you require a backup of the NSP deployer host configuration. A backup is created during NSP system deployment or reconfiguration, and also by performing [12.14 “How do I back up the NSP deployer host?”](#) (p. 325).

12.15.2 Steps

1

Log in as the root user on the station that hosts the NSP deployer host VM.

2

Open a console window.

3

Create a temporary local directory.

i **Note:** The directory must be empty.

4

Enter the following:

```
# cd directory ↵
```

where *directory* is the temporary directory created in [Step 3](#).

5

Copy the NSP deployer host backup file set to the temporary directory.

6

Enter the following to convert the backup NSP deployer host qcow2 image to raw format:

```
# qemu-img convert -f qcow2 backup_image.qcow2 -O raw new_image.img ↵
```

where

backup_image is the backup image file name

new_image is a name to assign to the new image file

7

If the NSP deployer host is running, enter the following to stop the VM:

```
# virsh destroy VM ↵
```

where *VM* is the VM name

8

Enter the following to deploy the VM:

i **Note:** One “--network bridge=*bridge_name*” entry is required for each VM interface that you intend to configure.

```
# virt-install --connect qemu:///system --ram RAM --vcpu=vCPUs -n  
instance --os-type=linux --os-variant=rhel7 --disk path="new_image",  
device=disk,bus=virtio,format=raw,io=native,cache=none --network  
bridge=bridge_name --import & ↵
```

where

RAM is the required amount of VM RAM in the response to your Platform Sizing Request, in Mbytes; for example, 64 Gbytes is expressed as 65536, which is 64 x 1024 Mbytes

vCPUs is the required number of vCPU threads in the response to your Platform Sizing Request

instance is the name to assign to the VM

new_image is the name of the disk image created in [Step 6](#)

bridge_name is the name of the network bridge for a VM interface

9

When the VM creation is complete, enter the following:

```
# virsh domiflist deployer_host | awk '{print $5}' ↵
```

where *deployer_host* is the instance name assigned to the VM

The NSP deployer host MAC address is displayed.

10

Record the MAC address for use in a later step.

11

Enter the following to open a console session as the root user on the NSP deployer host:

```
# virsh console deployer_host ↵
```

12

Open the following file with a plain-text editor such as vi:

```
/etc/sysconfig/network-scripts/ifcfg-ethn
```

where

n is the Ethernet interface number; for example, eth0 is the first interface

13

Edit the following line as shown below:

```
HWADDR=MAC_address
```

where *MAC_address* is MAC address recorded in [Step 9](#)

14

Save and close the file.

15

Enter the following:

```
# init 6 ↵
```

The NSP deployer host station reboots, and the NSP deployer host is restored.

16

Close the console window.

END OF STEPS

12.16 How do I replace an NSP cluster node?

12.16.1 Purpose

The following steps describe how to replace a node in an NSP cluster, as may be required in the event of a node failure.



Note: If root access for remote operations is disabled in the NSP configuration, remote operations such as SSH and SCP as the root user are not permitted within an NSP cluster. Steps that describe such an operation as the root user must be performed as the designated non-root user with sudoer privileges.

For simplicity, such steps describe only root-user access.



Note: *release-ID* in a file path has the following format:

R.r.p-rel.version

where

R.r.p is the NSP release, in the form *MAJOR.minor.patch*

version is a numeric value

Node replacement in a standalone deployment

In order to perform the procedure in a standalone NSP deployment, the following must be true.

- Scheduled NSP backups are enabled, as described in [Chapter 22, “Classic management database administration”](#).
- A recent NSP system backup is available.

i **Note:** If you need to replace a node in a standalone NSP cluster and do not have a recent NSP system backup, you cannot use the procedure to replace the node. Instead, you must recreate the cluster configuration; contact technical support for assistance.



CAUTION

Service outage

Performing the procedure in a standalone NSP deployment causes a service outage.

Ensure that you perform the procedure only during a scheduled maintenance period with the supervision of Nokia technical support.

12.16.2 Steps

Acquire node information

1 _____

Log in as the root user on the NSP cluster host in the NSP cluster that requires the node replacement.

2 _____

Open a console window.

3 _____

Enter the following to show the node roles:

```
# kubectl get nodes --show-kind ↵
```

Output like the following is displayed; the example below is for a three-node cluster:

| NAME | STATUS | ROLES | AGE | VERSION |
|------------|--------|----------------------|-----|---------|
| node/node1 | Ready | control-plane,master | 18d | v1.20.7 |
| node/node2 | Ready | control-plane,master | 18d | v1.20.7 |
| node/node3 | Ready | <none> | 18d | v1.20.7 |

If the Roles value for the node you are replacing includes control-plane or master, the node has a master role; if the value is <none>, the node is a worker node.

4 _____

Enter the following to show the node labels:

```
# kubectl get nodes node_name --show-labels ↵
```

| NAME | STATUS | ROLES | AGE | VERSION | LABELS |
|-------|--------|----------------------|-------|---------|--|
| node1 | Ready | control-plane,master | 4d12h | v1.20.7 | act=true,backup=true,beta.kubernetes.io/arch=amd64,beta.kubernetes.io/os=linux,elastic-search=true,etcd=true,file-service=true,kafka=true,kubernetes.io/arch=amd64,kubernetes.io/hostname=loriek8s-k8sc-node1,kubernetes.io/os=linux,mdm=true,neo4j-nr=true,neo4j=true,node-role.kubernetes. |

```
io/control-plane=,node-role.kubernetes.io/master=,nracs=true,  
postgresql=true,prometheus=true,rabbitmq=true,rta-detector=true,  
rta-ignite=true,rta-trainer=true,rta-windower=true,solr=true,wfm=true,  
zookeeper=true
```

5

Record the command output, which is required later in the procedure.

6

If the node to be replaced is not in a standalone single-node cluster, you can skip this step.

You must determine which NSP databases to restore on the replacement node.

Make note of which of the database entries in [Table 12-1, “NSP cluster node labels and associated data”](#) (p. 330) are in the [Step 4](#) command output.

i **Note:** Although the output may include “nsp-sdn=true”, the IPRC Tomcat database is installed only if IP resource control is enabled using an installation option in the nsp-config.yml file.

Table 12-1 NSP cluster node labels and associated data

| Node label | Data or database |
|---------------------------|-----------------------|
| etcd=true | Kubernetes etcd data |
| nsp-file-service-app=true | NSP file service data |
| postgresql=true | PostgreSQL database |
| nsp-sdn=true | IPRC Tomcat database |
| neo4j-nr=true, neo4j=true | Neo4j database |
| nsp-nrcx=true | Cross-domain database |

Ensure correct DR cluster roles

7

If the NSP system is not a DR deployment, skip this step.

In order to replace an NSP cluster node, the node must be in the standby cluster. After the failure of an DR NSP cluster node that hosts an essential NSP service, an NSP switchover automatically occurs. However, no automatic switchover occurs for a node that does not host an essential service.

If the node to replace is currently in the primary NSP cluster, perform [16.4 “How do I perform an NSP DR switchover?”](#) (p. 373).

Preserve NSP cluster data

8

Log in as the root user on the NSP deployer host.

9

Open a console window.

10

Configure the NSP to preserve the NSP cluster data.

1. Open the following file using a plain-text editor such as vi:

```
/opt/nsp/NSP-CN-DEP-release-ID/NSP-CN-release-ID/config/nsp-config.yml
```

2. Edit the following line in the **platform** section, **kubernetes** subsection to read as shown below:

```
deleteOnUndeploy:false
```

3. Save and close the file.

Stop NSP cluster

11

Enter the following:

```
# cd /opt/nsp/NSP-CN-DEP-release-ID/bin ↵
```

12

Enter the following:

i **Note:** In a standalone deployment, performing this step marks the beginning of the service outage.

i **Note:** If the NSP cluster VMs do not have the required SSH key, you must include the `--ask-pass` argument in the command, as shown in the following example, and are subsequently prompted for the root password of each cluster member:

```
nspdeployerctl --ask-pass uninstall --undeploy
```

```
# ./nspdeployerctl uninstall --undeploy ↵
```

The NSP stops.

Reconfigure and start cluster

13

If the replacement node has the same IP address as the node you are replacing, skip this step.

Update the node IP address in the NSP cluster configuration.

1. Open the following file on the NSP deployer host using a plain-text editor such as vi:

```
/opt/nsp/nsp-k8s-deployer-release-ID/config/k8s-deployer.yml
```

2. Change the former node IP address to the new IP address.
3. Save and close the file.
4. Enter the following:

```
# cd /opt/nsp/nsp-k8s-deployer-release-ID/bin ↵
```

5. Enter the following:

```
# ./nspk8sctl config -c ↵
```

A new /opt/nsp/nsp-k8s-deployer-release-ID/config/hosts.yml file is created.

14

Distribute the required SSH key to the new VM.

1. If remote root access is disabled, switch to the designated root-equivalent user.
2. Enter the following:

```
# ssh-copy-id -i key_file user@address ↵
```

where

key_file is the SSH key file, for example, /home/*user*/.ssh/id_rsa.pub

address is the replacement node IP address

user is the designated NSP ansible user, if root-user access is restricted; otherwise, *user@* is not required

The SSH key is transferred to the replacement node.

3. If remote root access is disabled, switch back to the root user.

15

Enter the following:

i **Note:** If the NSP cluster VMs do not have the required SSH key, you must include the `--ask-pass` argument in the command, as shown in the following example, and are subsequently prompted for the root password of each cluster member:

```
nspk8sctl --ask-pass uninstall
```

```
# ./nspk8sctl uninstall ↵
```

The Kubernetes software in the cluster is uninstalled.

16

Enter the following:

i **Note:** If the NSP cluster VMs do not have the required SSH key, you must include the `--ask-pass` argument in the command, as shown in the following example, and are subsequently prompted for the root password of each cluster member:

```
nspk8sctl --ask-pass install
```

```
# ./nspk8sctl install ↵
```

The Kubernetes software in the cluster is re-installed.

17

Add the labels from the former node to the replacement node.

1. Enter the following:

```
# cd /opt/nsp/NSP-CN-DEP-release-ID/bin ↵
```

2. Enter the following:

```
# ./nspdeployerctl config ↵
```

3. On the NSP cluster host, enter the following:

```
# kubectl get nodes node --show-labels ↵
```

where *node* is the node name

4. Verify that the labels match the labels recorded in [Step 4](#).

18

Update the node IP address in the NSP software configuration file.

1. Open the following file on the NSP deployer host using a plain-text editor such as vi:

```
/opt/nsp/NSP-CN-DEP-release-ID/NSP-CN-release-ID/config/nsp-config.yml
```

2. If the former node IP address is present in the file, replace it with the new IP address.
3. Save and close the file.

19

Enter the following on the NSP deployer host:



Note: If the NSP cluster VMs do not have the required SSH key, you must include the `--ask-pass` argument in the command, as shown in the following example, and are subsequently prompted for the root password of each cluster member:

```
nspdeployerctl --ask-pass install --config
```

```
# /opt/nsp/NSP-CN-DEP-release-ID/bin/nspdeployerctl install --config ↵
```

The new node IP address is propagated to the deployment configuration.

20

Perform one of the following.



Note: If the NSP cluster VMs do not have the required SSH key, you must include the `--ask-pass` argument in the following command, as shown in the following example, and are subsequently prompted for the root password of each cluster member:

```
nspdeployerctl --ask-pass install --deploy
```

- a. If the NSP is deployed in a DR configuration, enter the following on the standby NSP deployer host:

```
# /opt/nsp/NSP-CN-DEP-release-ID/bin/nspdeployerctl install --deploy ↵
```

The NSP starts.

- b. If the NSP system is configured as an enhanced deployment without DR, you must ensure

that the PostgreSQL and Neo4j databases in the cluster initialize on an existing node, and not on the replacement node, by cordoning the replacement node until after the initialization.

1. Enter the following on the NSP cluster host:

```
# kubectl cordon node ↵
```

where *node* is the node name

The replacement node is cordoned.

2. On the NSP deployer host, enter the following:

```
# /opt/nsp/NSP-CN-DEP-release-ID/bin/nspdeployerctl install  
--deploy ↵
```

3. On the NSP cluster host, enter the following:

```
# kubectl get pods -A ↵
```

The pods are listed.

4. View the output; if all of the following are not true, repeat [3](#).

Note: You must not proceed to the next step until the conditions are met.

- One postgres-primary pod instance is in the Running state.
- At least two nspos-neo4j-core pod instances are in the Running state.
- At least two nsp-tomcat pod instances are in the Running state.
- If nrcx-tomcat is installed, at least two nrcx-tomcat pods are in the Running state.

5. When the conditions are met, enter the following:

```
# kubectl uncordon node ↵
```

The replacement node is uncordoned.

- c. If the node to be replaced is not in a DR or enhanced deployment, skip this step.

Perform [13.6 “How do I restore the NSP cluster databases?”](#) (p. 350) using a copy of the appropriate NSP system backup, which is typically the most recent.



Note: Do not perform [Step 4](#), which deletes all databases.



Note: You must restore only the databases identified in [Step 6](#).



Note: The restore procedure starts the NSP cluster when the restore is complete.

21

Back up the NSP cluster data, as described in [13.4 “How do I back up the NSP cluster databases?”](#) (p. 343).

22

Close the open console windows.

END OF STEPS

12.17 How do I restore the NSP Elasticsearch log data?

12.17.1 Purpose

Perform this procedure to restore legacy NSP Elasticsearch log data from a backup.

12.17.2 Steps

1 _____
Log in as the root user on a station that has the downloaded NSP_DEPLOYER_R_r.tar.gz file.

2 _____
Navigate to the directory that contains the NSP_DEPLOYER_R_r.tar.gz file.

3 _____
Enter the following:

```
# tar xvf NSP_DEPLOYER_R_r.tar.gz *nsp-log-collector.zip *README.txt ↵
```

The nsp-log-collector.zip file and a README.txt file are extracted to the following directory path below the current directory:
NSP-CN-DEP-*release-ID*/NSP-CN-*release-ID*/tools/support/logCollector

 **Note:** The README.txt contains information about using the backup utility.

4 _____
Log in as the root user on the NSP cluster host:

5 _____
Open a console window.

6 _____
Transfer the extracted nsp-log-collector.zip and README.txt files to the current directory.

7 _____
Transfer the Elasticsearch backup .zip file to the NSP cluster host.

8 _____
Enter the following:

```
# unzip nsp-log-collector.zip ↵
```

The following files are created in the current directory:

- nsp-log-collector
- nsp-log-collector.bat

9

After the files are extracted, enter the following:

```
# cd nsp-log-collector-release-ID/bin ↵
```

10

Enter the following to back up all collected Elasticsearch log data:

```
# ./nsp-log-collector --postAll backup_file ↵
```

where *backup_file* is the absolute path of the backup file

The log data files are extracted to the specified location.

11

Close the console window.

END OF STEPS

13 NSP cluster database administration

13.1 How do I check NSP database synchronization?

13.1.1 Purpose

Perform this procedure to check the synchronization status of the database instances in the redundant NSP clusters of a DR deployment. You can check the synchronization status from the NSP UI, or using a CLI.

13.1.2 Steps

Check database synchronization from the NSP UI

1

As an NSP administrator, choose **System Health** from the NSP main menu.

2

View the information in the Database Synchronization Status panel, which lists the synchronization completion percentage for the following:

- graph.db—Neo4j database
- postgres—PostgreSQL database
- system—internal NSP database

To view expanded details for a database, click  **View** on the list item.

END OF STEPS

13.1.3 Steps

Check database synchronization using a CLI

1

Log in as the root user on the NSP cluster host in the primary data center.

2

Open a console window.

3

Enter the following:

```
# kubectl exec -n $(kubectl get pods -A | awk '/nspos-asm/ {print $1;exit}') -it $(kubectl get pods -A | awk '/nspos-asm/ {print $2;exit}') -c nspos-asm-app -- /opt/nsp/os/asm/bin/report.py ↵
```

4

Database synchronization data is returned in the following format:

```
{
  "message": "Data retrieved",
  "data":
  [
    {
      "dcName": "string",
      "dbName": "string", // postgres|neo4j
      "podName": "string",
      "role": "string", // PRIMARY|STANDBY for postgres,
      LEADER|FOLLOWER|READ_REPLICA for neo4j
      "activeSize": "string",
      "sizeUnit": "string", // Bytes for postgres, Commits for neo4j
      "isInRecovery": null, // or boolean for postgres
      "isReplayPaused": null, // or boolean for postgres
      "receivedSize": null, // or string for postgres
      "replaySize": null, // or string for non primary/leader instances
      "lastReplayTimeStamp": null, // or timestamp string for postgres
      "missingSize": null, // or string for non primary pg instances
      "dataToTransfer": null, // or string for non primary pg instances
      "dataToProcess": null, // or string for non primary/leader instances
      "syncPercentage": double // real number 0-100
    },
  ],
  "status": "success"
}
```

5

Review the information.

6

Close the console window.

END OF STEPS

13.2 How do I back up and restore the NSP cluster data?

13.2.1 Introduction

The procedures in this section describe how to back up and restore the system data and application databases of an NSP cluster.

i **Note:** The following RHEL CLI prompts in command lines denote the active user, and are not to be included in typed commands:

- #—root user
- bash\$—nsp user

i **Note:** NSP Analytics data, such as the report repository contents, are stored in the PostgreSQL database, so are included in the database backup and restore operations described; no separate backup or restore process is required for Analytics data.

Integrated deployments

In an NSP system that has integrated components such as the NFM-P or WS-NOC, it is strongly recommended that you synchronize the backup and restore operations among the components. See the WS-NOC backup and restore documentation, and [Chapter 22, “Classic management database administration”](#), as required.

NSP database failure alarms

The NSP raises the following alarms in the event of a suspected PostgreSQL database failure:

i **Note:** The alarms are not auto-clearing, so must be cleared manually.

- Critical—the leader database is unresponsive
- Major—at least one follower database is unresponsive

Identifying the source of a database alarm

The NSP and an integrated NFM-P raise similar alarms in response to a database failure.

Before you take action to respond to a database alarm, you must clearly identify the system raising the alarm and the database instance at fault.

The Source Type field of a database failure alarm indicates whether the alarm source is the NSP or NFM-P.

The Site ID and Site Name fields identify the following:

- NFM-P alarm—the NFM-P main server that raised the alarm
- NSP alarm—the faulty PostgreSQL database instance

i **Note:** Regardless of the source system, the Additional Text field contains the IP address of the database instance that is at fault.

For example, the Source Type field of a standby database failure alarm contains “NFM-P”. An operator views the Site Name field, which identifies the NFM-P main server that has reported the

fault. The operator then views the Additional Text field, and learns that the standby database associated with the main server has failed.

When a similar NSP alarm is raised, the operator has to view only the Site ID or Site Name field to identify which PostgreSQL database instance is at fault.

13.3 How do I configure scheduled NSP backups?

13.3.1 Purpose

Perform this procedure to configure scheduled backups of the following NSP cluster databases:

- Kubernetes etcd data
- NSP file service data
- Neo4j
- PostgreSQL
- nspos-solr
- nsp-tomcat
- nrcx-tomcat

Scheduled backups are enabled by default, and scheduled to run daily at 12:30 AM UTC.

i **Note:** By default, the NSP retains the three most recent scheduled backups.

i **Note:** *release-ID* in a file path has the following format:

R.r.p-rel.version

where

R.r.p is the NSP release, in the form *MAJOR.minor.patch*

version is a numeric value

13.3.2 Steps

1 _____

Log in as the root user on the NSP deployer host.

2 _____

Open the following file with a plain-text editor such as vi:

/opt/nsp/NSP-CN-DEP-release-ID/NSP-CN-release-ID/config/nsp-config.yml

3 _____

Locate the section that begins with the following:

```
backups :
```

4 _____

Configure the following parameters:

i **Note:** If the schedule value is an empty string, no scheduled backup is performed.

i **Note:** See the RHEL cron man page for information about defining a crontab schedule.

```
schedule: "definition"  
retained: n
```

where

definition is a UNIX crontab schedule definition; for example, "30 0 * * *" specifies the default backup schedule of 12:30 a.m. daily

n is the number of backups to retain

5

Save and close the file.

END OF STEPS

13.4 How do I back up the NSP cluster databases?

13.4.1 Purpose

Perform this procedure to manually create a backup of one or more of the following in an NSP cluster:

- Kubernetes etcd data
- NSP file service data
- Neo4j
- PostgreSQL
- nspos-solr
- nsp-tomcat
- nrcx-tomcat

i **Note:** *release-ID* in a file path has the following format:

R.r.p-rel.version

where

R.r.p is the NSP release, in the form *MAJOR.minor.patch*

version is a numeric value

13.4.2 Steps

1

Log in as the root user on the NSP deployer host.

2

Open a console window.

3

If a common backup storage location is defined in the NSP configuration, go to [Step 8](#).

4

Open the following file with a plain-text editor such as vi:

```
/opt/nsp/NSP-CN-DEP-release-ID/NSP-CN-release-ID/config/nsp-config.yml
```

5

If the **clusterProvider** in the NSP configuration is set to 'customer' as shown below, perform one of the following.

```
kubernetes:  
  clusterProvider: "customer"
```

a. To use an existing PVC, perform the following steps:

i **Note:** The PVC must support ReadWriteMany semantics.

1. Locate the section that begins with the following:

```
kubernetes:
```

2. Configure the following parameter in the section:

```
  rwxClass: "class"
```

where *class* is the storage class

3. Locate the section that begins with the following:

```
  backups:
```

4. Configure the following parameter in the section:

```
    existingClaim: "store"
```

where *store* is the name of the PVC store

b. To use an existing storage class that supports ReadWriteMany semantics, perform the following steps.

1. Locate the section that begins with the following:

```
  backups:
```

2. Configure the following parameters in the following subsection by adding the lines in boldface type:

```
    storage:  
      create:  
        storageClass: class  
        capacity: size
```

where

class is the storage class

size is the storage class capacity

6

If required, configure the backups to be stored on an NFS server.

1. Locate the section that begins with the following:

```
backups:
```

2. Configure the following parameters in the following subsection:

```
nfs:
  server: "server"
  path: "path"
```

where

server is the NFS server IP address

path is the path of the exported file system on the server

7

If you made any changes to the `nsp-config.yml` file in [Step 5](#) or [Step 6](#), enter the following to apply the changes to the cluster:

i **Note:** If the NSP cluster VMs do not have the required SSH key, you must include the `--ask-pass` argument in the command, as shown in the following example, and are subsequently prompted for the root password of each cluster member:

```
nspdeployerctl --ask-pass install --config --deploy
# /opt/nsp/NSP-CN-DEP-release-ID/bin/nspdeployerctl install --config
--deploy ↵
```

8

Enter the following:

```
# cd /opt/nsp/NSP-CN-DEP-release-ID/NSP-CN-release-ID/tools/database ↵
```

9

Enter one or more of the following, as required, to back up system data and databases:

i **Note:** It is recommended that you back up all system data and databases.

i **Note:** You must not proceed to the next step until each backup job is complete.

- a. To back up the NSP Kubernetes etcd data:

```
# ./nspos-db-backup-k8s.sh nsp-etcd backup_dir ↵
```

- b. To back up the NSP file service data:

```
# ./nspos-db-backup-k8s.sh nsp-file-service backup_dir ↵
```

- c. To back up the NSP Neo4j database:

```
# ./nspos-db-backup-k8s.sh nspos-neo4j backup_dir ↵
```

- d. To back up the NSP PostgreSQL database:

```
# ./nspos-db-backup-k8s.sh nspos-postgresql backup_dir ↵
```

e. To back up the NSP Solr database:

```
# ./nspos-db-backup-k8s.sh nspos-solr backup_dir ↵
```

f. To back up the NSP Tomcat database:

```
# ./nspos-db-backup-k8s.sh nsp-tomcat backup_dir ↵
```

g. To back up the cross-domain Tomcat database:

```
# ./nspos-db-backup-k8s.sh nrcx-tomcat backup_dir ↵
```

where *backup_dir* is the directory in which to store the backup

The backup script displays messages like the following as a backup job proceeds:

```
----- BEGIN : Backing up database-backup -----  
job.batch/backup_job created  
timestamp LOG: Waiting for job backup_job at namespace namespace to  
finish...  
timestamp LOG: backup done successfully  
timestamp LOG: Removing job backup_job at namespace namespace  
job.batch "backup_job" deleted  
timestamp LOG: Job backup_job at namespace namespace deleted  
----- END : Backing up database_backup -----  
----- BEGIN : Fetching backup database -----  
timestamp LOG: Fetching database backup from pod nsp-backup-storage-0  
at namespace namespace  
timestamp LOG: Latest database backup is database_backup_timestamp.  
tar.gz  
tar: removing leading '/' from member names  
timestamp LOG: Latest database backup fetched successfully  
----- END : Fetching backup database -----
```

A backup filename has the following format:

```
database_backup_timestamp.tar.gz
```

where

database is the database name, for example, nspos-neo4j

timestamp is the start time of the database backup

10

Copy all secret files in the following directory on the NSP deployer host to *backup_dir*:
/opt/nsp/nsp-configurator/generated/

11

Transfer the files from *backup_dir* to a secure location for safekeeping.



Note: It is strongly recommended that you transfer each backup file to a secure facility that is outside the local data center.

12

Close the console window.

END OF STEPS

13.5 How do I restore the Kubernetes etcd data in an NSP cluster?

13.5.1 Purpose



CAUTION

System Data Corruption

Attempting to restore the etcd data from one NSP cluster to a different NSP cluster causes the restore to fail, and renders the NSP cluster unrecoverable.

You must restore only an etcd data backup from the same NSP cluster; you cannot move an NSP cluster configuration to a different cluster, or restore a cluster configuration in a new cluster.

An etcd data backup, called a snapshot, captures all Kubernetes objects and associated critical information. A scheduled etcd data snapshot is performed daily. The following procedure describes how to recover a failed NSP cluster by restoring the etcd data from a snapshot.

13.5.2 Steps

Obtain and distribute snapshot

1

Log in as the root user on the NSP cluster host.

2

Enter the following to identify the namespace of the nsp-backup-storage pod:

```
# kubectl get pods -A | grep nsp-backup ↵
```

The leftmost entry in the output line is the namespace, which in the following example is nsp-psa-restricted:

```
nsp-psa-restricted    nsp-backup-storage-0    1/1    Running    0    5h16m
```

3

Record the namespace value.

4

Enter the following to identify the etcd snapshot to restore:

```
# kubectl exec -n namespace nsp-backup-storage-0 - ls -la  
/tmp/backups/nsp-etcd/ ↵
```

where *namespace* is the namespace value recorded in [Step 3](#)

The directory contents are listed; the filename format of an etcd snapshot is:

nsp-etcd_backup_*timestamp*.tar.gz

where *timestamp* is the snapshot creation time

5

Record the name of the snapshot file that you need to restore.

6

Enter the following to copy the snapshot file from the backup pod to an empty directory on the local file system:

```
# kubectl cp namespace/nsp-backup-storage-0:  
/tmp/backups/nsp-etcd/snapshot_file_path/snapshot_file ↵
```

where

namespace is the namespace value recorded in [Step 3](#)

path is an empty local directory

snapshot_file is the snapshot file name recorded in [Step 5](#)

7

Enter the following:

i **Note:** The file lists either one member, or three, depending on the deployment type.

```
# grep ETCD_INITIAL /etc/etcd.env ↵
```

Output like the following is displayed.

```
ETCD_INITIAL_ADVERTISE_PEER_URLS=https://local_address:port
```

```
ETCD_INITIAL_CLUSTER_STATE=existing
```

```
ETCD_INITIAL_CLUSTER_TOKEN=k8s_etcd
```

```
ETCD_INITIAL_CLUSTER=etcd1=https://address_1:port,etcd2=https:  
//address_2:port,etcd3=https://address_3:port
```

where

local_address is the IP address of the etcd cluster member you are operating from

address_1, *address_2*, and *address_3* are the addresses of all etcd cluster members

port is a port number

8

Perform the following on each etcd cluster member.

i **Note:** After this step, the etcd cluster is unreachable until the restore is complete.

1. Log in as the root user.
2. Enter the following:

```
# systemctl stop etcd ↵
```

The etcd service stops.
3. Transfer the snapshot file obtained in [Step 7](#) to the cluster member.

Restore database on etcd cluster members

9

Perform [Step 11](#) to [Step 19](#) on each etcd cluster member.

10

Go to [Step 20](#).

11

Log in as the root user.

12

Navigate to the directory that contains the transferred snapshot file.

13

Enter the following:

```
# tar xzf path/nsp-etcd_backup_timestamp.tar.gz ↵
```

where

path is the absolute path of the snapshot file

timestamp is the snapshot creation time

The snapshot file is uncompressed.

14

Enter the following:

```
# ETCDCCTL_API=3 etcdctl snapshot restore etcd.db --name member  
--initial-cluster initial_cluster --initial-cluster-token token  
--initial-advertise-peer-urls URL ↵
```

where

member is the name of the cluster member you are working on, for example, etcd2

initial_cluster is the ETCD_INITIAL_CLUSTER list of cluster members recorded in [Step 7](#)

token is the ETCD_INITIAL_CLUSTER_TOKEN value recorded in [Step 7](#)

URL is the URL of the cluster member you are working on; for example, the etcd2 cluster member URL shown in [Step 7](#) is `https://address_2:port`

The etcd database is restored.

15

Enter the following to create a directory in which to store the previous database:

```
# mkdir path/old_etcd_db ↵
```

where *path* is the absolute path of the directory to create

16

Enter the following to move the previous database files to the created directory:

```
# mv /var/lib/etcd/* path/old_etcd_db ↵
```

where *path* is the absolute path of the directory created in [Step 15](#)

17

Enter the following:

```
# mv ./member.etcd/* /var/lib/etcd/ ↵
```

where *member* is the member name specified in [Step 14](#)

The backup files move to the */var/lib/etcd* directory.

18

Enter the following:

```
# systemctl start etcd ↵
```

The etcd service starts.

19

Enter the following:

```
# systemctl status etcd ↵
```

The etcd service status is displayed.

The service is up if the following is displayed:

```
Active: active (running)
```

20

When the etcd service is up, close the open console windows.

END OF STEPS

13.6 How do I restore the NSP cluster databases?

13.6.1 Purpose

Perform this procedure to restore one or more of the following in each NSP cluster:

- NSP file service data
- Neo4j database
- PostgreSQL database

- nspos-solr database
- nsp-tomcat database
- nrcx-tomcat database

i **Note:** The Neo4j, nsp-tomcat, and nrcx-tomcat database backup files are each named graph.db. You must ensure that you are using the correct graph.db backup file when you restore the Neo4j, nsp-tomcat, or nrcx-tomcat database.

i **Note:** If you are performing the procedure as part of a system conversion, migration, or upgrade procedure in a DR deployment, you must perform the procedure only in the new primary NSP cluster.

i **Note:** You can specify a local backup file path, or a remote path, if the remote server is reachable from the NSP deployer host and from the NSP cluster host.

To specify a remote path, use the following format for the *backup_file* parameter in the command, where *user* has access to *backup_file* at the *server* address:

```
user@server:/backup_file
```

i **Note:** If root access for remote operations is disabled in the NSP configuration, remote operations such as SSH and SCP as the root user are not permitted within an NSP cluster. Steps that describe such an operation as the root user must be performed as the designated non-root user with sudoer privileges.

For simplicity, such steps describe only root-user access.

i **Note:** *release-ID* in a file path has the following format:

R.r.p-rel.version

where

R.r.p is the NSP release, in the form *MAJOR.minor.patch*

version is a numeric value

13.6.2 Steps

Prepare to restore databases

1 _____

Log in as the root user on the NSP deployer host.

2 _____

Open a console window.

3 _____

If you are restoring the data on new NSP cluster VMs, create and distribute an SSH key for password-free NSP deployer host access to each VM.

1. If remote root access is disabled, switch to the designated root-equivalent user.
2. Enter the following:

```
# ssh-keygen -N "" -f path -t rsa ↵
```

where *path* is the SSH key path, for example, */home/user/.ssh/id_rsa*

3. Enter the following for each new VM to distribute the key to the VM.

```
# ssh-copy-id -i key_file user@address ↵
```

where

key_file is the SSH key file, for example, */home/user/.ssh/id_rsa.pub*

address is the IP address of the new VM

user is the designated NSP ansible user, if root-user access is restricted; otherwise, *user@* is not required

The SSH key is transferred to the VM.

4. If remote root access is disabled, switch back to the root user.

4

Perform one of the following.

i **Note:** You must not proceed to the next step until the cluster is ready.

- a. If both of the following are true, you must stop each cluster and remove all existing cluster data:

- You are restoring the data in an existing NSP cluster, rather than on new NSP cluster VMs.
- You are restoring all NSP databases.

Perform the following steps on the NSP deployer host in each NSP cluster.

i **Note:** In a DR deployment, you must perform the steps first on the standby cluster.

i **Note:** If the NSP cluster VMs do not have the required SSH key, you must include the `--ask-pass` argument in the command, as shown in the following example, and are subsequently prompted for the root password of each cluster member:

```
nspdeployerctl --ask-pass uninstall --undeploy
```

1. Log in as the root user.
2. Open the following file with a plain-text editor such as `vi`:
`/opt/nsp/NSP-CN-DEP-release-ID/NSP-CN-release-ID/config/nsp-config.yml`
3. Edit the following line in the **platform** section, **kubernetes** subsection to read as shown below:

```
deleteOnUndeploy:true
```

4. Save and close the file.
5. Enter the following:

```
# cd /opt/nsp/NSP-CN-DEP-release-ID/bin ↵
```

6. Enter the following:

```
# ./nspdeployerctl uninstall --undeploy ↵
```

The NSP cluster is undeployed, and the existing data is removed.

- b. If you are not restoring all databases, you must delete only the existing data in each database that you are restoring.

Perform the following steps on the NSP deployer host in each NSP cluster.

i **Note:** In a DR deployment, you must perform the steps first on the NSP cluster that you want to start as the standby cluster.

1. Log in as the root user.
2. Open the following file using a plain-text editor such as vi:
`/opt/nsp/NSP-CN-DEP-release-ID/NSP-CN-release-ID/config/nsp-config.yml`
3. Edit the following line in the **platform** section, **kubernetes** subsection to read as shown below:

```
deleteOnUndeploy:false
```

4. Save and close the file.
5. On each NSP cluster node, enter the following for each database that you are restoring:

Note: Database instances are dynamically allocated to NSP cluster nodes, so some nodes may not have an instance of a specific database. If a database instance is not present on a node; the command returns an error message that you can safely ignore.

```
# rm -rf /opt/nsp/volumes/db_name/* ↵
```

where *db_name* is the database name, and is one of:

- nsp-file-service
- nspos-neo4j
- nspos-postgresql
- nspos-solr
- nsp-tomcat
- nrcx-tomcat

Enable NSP restore mode

5

Enter the following on the NSP deployer host:

```
# cd /opt/nsp/NSP-CN-DEP-release-ID/bin ↵
```

6

Enter the following to enter restore mode:

i **Note:** If the NSP cluster VMs do not have the required SSH key, you must include the `--ask-pass` argument in the command, as shown in the following example, and are subsequently prompted for the root password of each cluster member:

```
nspdeployerctl --ask-pass install --config --restore
```

```
# ./nspdeployerctl install --config --restore ↵
```

7

The following NSP cluster pods must be operational before the restore begins:

- `nsp-backup-storage-n`
- `nspos-neo4j-core-default-n`
- `nspos-postgresql-primary-n`
- `nsp-file-service-app-n`
- `nspos-solr-statefulset-n`
- present only if MDM or IPRC-related installation options are enabled:
 - `nsp-tomcat-dc_name-n`
 - `nrcx-tomcat-dc_name-n`where `dc_name` is the `dcName` value in the cluster configuration file

Enter the following periodically to list the pods; the cluster is ready for the restore when each required pod is in the Running state:

```
# kubectl get pods -A ↵
```

8

If any required pod is not Running, return to [Step 7](#).

 **Note:** A restore attempt fails unless each required pod is Running.

Restore data

9

Enter the following on the NSP deployer host:

```
# cd /opt/nsp/NSP-CN-DEP-release-ID/NSP-CN-release-ID/tools/database ↵
```

10

Enter one or more of the following, as required, to restore system data and databases:

 **Note:** In a DR deployment, you must perform the steps first in the data center that you want to start as the primary data center.

a. To restore the NSP file service data:

```
# ./nspos-db-restore-k8s.sh nsp-file-service backup_dir/backup_file ↵
```

b. To restore the NSP Neo4j database:

```
# ./nspos-db-restore-k8s.sh nspos-neo4j backup_dir/backup_file ↵
```

c. To restore the NSP PostgreSQL database:

```
# ./nspos-db-restore-k8s.sh nspos-postgresql backup_dir/backup_file ↵
```

d. To restore the NSP Solr database:

```
# ./nspos-db-restore-k8s.sh nspos-solr backup_dir/backup_file ↵
```

e. To restore the NSP Tomcat database:

```
# ./nspos-db-restore-k8s.sh nsp-tomcat backup_dir/backup_file ↵
```

f. To restore the cross-domain Tomcat database:

```
# ./nspos-db-restore-k8s.sh nrcx-tomcat backup_dir/backup_file ↵
```

where
backup_dir is the directory that contains the backup file
backup_file is the backup file name, for example, for PostgreSQL, the name is `nspos-postgresql_backup_timestamp.tar.gz`

Start NSP clusters

11

Perform the following steps in each data center.



Note: In a DR deployment, you must perform the steps first in the data center that you want to start as the primary data center.



Note: If the NSP cluster VMs do not have the required SSH key, you must include the `--ask-pass` argument in the following commands, as shown in the following example, and are subsequently prompted for the root password of each cluster member:

```
nspdeployerctl --ask-pass uninstall --undeploy | nspdeployerctl  
install --deploy
```

1. Log in as the root user on the NSP deployer host.
2. Open a console window.
3. Open the following file with a plain-text editor such as `vi`:
`/opt/nsp/NSP-CN-DEP-release-ID/NSP-CN-release-ID/config/nsp-config.yml`
4. Edit the following line in the **platform** section, **kubernetes** subsection to read as shown below:

```
deleteOnUndeploy:false
```
5. Save and close the file.
6. Enter the following:

```
# cd /opt/nsp/NSP-CN-DEP-release-ID/bin ↵
```
7. Enter the following to exit restore mode and terminate the restore pods:

```
# ./nspdeployerctl uninstall --undeploy ↵
```
8. Open a CLI on the NSP cluster host.
9. Enter the following:

```
# kubectl get pods -A ↵
```

The pods are listed.
10. If any of the following restore pods is listed, the pod is not terminated; return to substep 9.

-
- nsp-file-service-app-*n*
 - nspos-neo4j-core-default-*n*
 - nspos-postgresql-primary-*n*
 - nspos-solr-statefulset-*n*
 - nsp-tomcat-dc_*name*-*n*
 - nrc-x tomcat-dc_*name*-*n*

Note: You must not proceed to the next step if a restore pod is listed.

11. Restore the nsp-keycloak-***-secret files from *backup_dir* specified during the previous database backup to the following NSP deployer host directory:

`/opt/nsp/nsp-configurator/generated/`

12. On the NSP deployer host, enter the following:

```
# ./nspdeployerctl install --deploy ↵
```

The NSP initializes using the restored data.

13. Enter the following periodically on the NSP cluster host to display the cluster status:

```
# kubectl get pods -A ↵
```

The cluster is operational when the status of each pod is Running.

12

Close the open console windows.

END OF STEPS

14 NSP logging and monitoring

14.1 What is System Health?

14.1.1 Description

The NSP System Health dashboard, which is in the Administration area of the NSP main menu, displays a number of system KPI representations.

The default view includes a graphical representation of the number of pods in each state, such as Running or Pending, for quick identification of problems. The view also lists relevant information for each pod, such as the pod uptime, host NSP cluster node, and number of pod restarts.

You can also invoke the following from the System Health dashboard:

- Log Viewer—local OpenSearch instance with dashboards for viewing and analyzing NSP application log data
- Grafana—local Grafana instance that draws on various data sources to provide visualizations and alerts

14.2 What are the System Health functions?

14.2.1 Monitoring NSP

From the NSP System Health dashboard, you can monitor NSP to quickly determine the overall operational quality of the system. To view more detailed information about aspects of NSP operation, you can use Grafana and NSP Log Viewer.

The Log Viewer collects, analyzes, and displays NSP application log information by invoking a local OpenSearch instance called OpenSearch Dashboards.

From the NSP System Health dashboard, you can also open a local Grafana instance.

14.2.2 OpenSearch Dashboards and Grafana

OpenSearch Dashboards and Grafana are third-party logging and monitoring functions that are built-in to the NSP. Each function displays a dashboard that displays system status and logging information.

NSP user credentials are required to view the tools. Additionally, Grafana has Admin, Editor, and Viewer roles that can be assigned through Users and Security.

See [14.3 “What is Log Viewer?” \(p. 358\)](#) and [14.4 “What is Grafana?” \(p. 358\)](#) for more information.

14.3 What is Log Viewer?

14.3.1 Overview

Log Viewer is a customizable NSP tool that uses the third-party OpenSearch utility to display all NSP application logs. All NSP application logs can be viewed in a Discover or Dashboard view.

Log Viewer analyzes the logs of NSP system elements such as the following:

- NSP clusters
- Tomcat servers
- ZooKeeper registry
- Kafka messaging system
- PostgreSQL database

The displayed logs can be searched, and filtered using custom criteria, or typical criteria such as the time of receipt.

OpenSearch documentation is available from the circular icon at the top-right of the browser window.

Log Viewer access

You can open Log Viewer using the LOG VIEWER button on the System Health dashboard, or by visiting the following URL:

`https://NSP_address/logviewer`

where *NSP_address* is the NSP address for client access

14.4 What is Grafana?

14.4.1 Overview

Grafana displays status information and metrics for NSP system elements. The following predefined dashboards are available:

- All Node Metrics
- All Pod Metrics
- Auxdb Agent
- Etcd Cluster Overview
- Data Collection and Analysis, Visualizations
- Kafka Server
- Keycloak Metrics
- NSP CPU/Memory/Disk Usage
- NSP Deployer Host Registry
- NSP General
- NSP JVM Metrics

- NSPOS Oauth2 Proxy Metrics
- Neo4j Server Dashboard
- Nginx Request Handling Performance
- ZooKeeper Server

The information displayed by each dashboard varies by information type. For example, the All Pod Metrics dashboard displays visual indicators of memory and CPU usage in addition to numeric memory-usage indicators. The NSP Pod Status dashboard displays status graphs for a variety of NSP system elements.

Grafana access

You can use the GRAFANA button on the System Health dashboard to open Grafana. The tool is also available at the following URL:

`https://NSP_address/grafana`

where *NSP_address* is the public NSP address

14.5 What is user activity log forwarding?

14.5.1 User activity log forwarding overview

If the forwarding of NSP user activity logs to a remote server is enabled, each NSP user action is forwarded to a remote syslog server specified in the NSP configuration during system deployment.

14.5.2 User activity syslog record format

Each generated remote syslog message for user activity has the following fields:

- timestamp
- hostname of syslog producer
- program name
- User Activity Log entry

User Activity Log syslog record example

The following is an example of an NFM-P User Activity Log record forwarded to a remote syslog server:

i **Note:** The record is displayed as three separate sections for illustration purposes; an actual record is contiguous.

```
May 18 09:56:36 nsp-1a3 activitylogs: {"app":"Users And Security",
"clientHost":"203.0.100.5","reqMethod":"POST","addlParams": "{}",
"actionParams": [{"val": "
\\"retentionPeriod\\":32,\\"activityLogsMaxSize\\":1000000,
\\"activityLogsWarningThreshold\\":95,\\"activityLogsCriticalThreshold\\":
100,\\"activityLogsWarningPurgePercent\\":5,
\\"activityLogsCriticalPurgePercent\\":10}
```

```
","key":"jsonRequest"}], "respCodePhrase":"OK", "timeStamp":"2020/05/27
10:47:14 821 +0000", "affObjs":"{}", "uid":
"a0d3b09f66acb238d9f95ab1155d075e", "host":"198.51.100.16", "action":"set",
"time":"1590576434821", "user":"admin", "reqURL":"https://198.51.100.
16/activitylogs-api/rest/api/v1/activityLogs/settings/set", "respCode":
"200"}
```

The fields in the example have the following values; the `actionParams` section, which is the second section in the example, indicates that the action involved setting user-activity log parameters:

- `timestamp`—May 18 09:56:36
- `hostname` of syslog entry producer—`nsp-1a3`
- `program name`—`activitylogs`
- `User Activity Log entry`—remainder that begins with `"app": "Users and Security"`; is in JSON format, and includes the following:
 - `app`—source NSP function from which action performed
 - `clientHost`—remote hostname or IP address that invokes action
 - `reqMethod`—type of action performed
 - `actionParams`—array; contains parameters passed to action
 - `addIParams`—array; contains parameters or other such values not in other fields
 - `respCodePhrase`—human-readable action response code
 - `timeStamp`—time at which action completed
 - `affObjs`—array of affected-object attributes, for example, FDN and ID
 - `uid`—record ID
 - `host`—IP address of server on which action performed
 - `action`—name of action performed
 - `user`—username under which action performed
 - `reqURL`—HTTP URL of the executed HTTP request
 - `respCode`—action response code, in integer format

14.6 What is the syslog record format for NSP application log forwarding?

14.6.1 Introduction

The NSP can be configured to forward NSP application-log entries for various functions, as well as NFM-P server log entries, to a remote syslog server, as described in the *NSP Installation and Upgrade Guide*. The following topics describe the syslog record formats of NSP application and NFM-P server log entries.

NSP application log entries

Different NSP functions log different types and amounts of information. Consequently, an NSP application log entry does not have a fixed length or number of fields, so the following topic describes only the syslog record format, and not each type of record entry.

NFM-P server log entries

When NFM-P server log forwarding is enabled, the standalone or primary NFM-P main server forwards each entry written to the local EmsServer.log file to the specified syslog server.

14.6.2 NSP application syslog record format

Each syslog record for an NSP functional area has the following fields:

- timestamp
- hostname of syslog message producer
- program name, which is appslogs
- log entry

i **Note:** The log entries do not share a common format, as the number and type of fields in an entry is function-specific.

The following is a syslog record entry example:

```
Nov 9 11:10:28 nsp-1a3 appslogs: {app-specific_log_entry}
```

The fields in the example record have the following values:

- timestamp—Nov 9 11:10:28
- hostname of syslog entry producer—nsp-1a3
- program name—appslogs
- log entry—*function-specific_log_entry*, which is a comma-separated list of colon-separated attribute-value pairs that contain the log-entry message and other information, for example:
"attribute1":"value","attribute2":"value","attribute3":"value"

14.6.3 NFM-P server syslog record format

Each NFM-P server log entry has the following fields:

- timestamp
- hostname of syslog message producer
- program name, which is nfmpserverlogs
- server log entry

The following is an example of a syslog record that contains an NFM-P server log entry:

```
Nov 7 05:40:15 nfmp-dc_1 nfmpserverlogs:{EMS_server_log_entry}
```

The fields in the example record have the following values:

- timestamp—Nov 7 05:40:15
- hostname of syslog entry producer—nfmp-dc_1
- program name—nfmpserverlogs
- server log entry—*EMS_server_log_entry*, which is a comma-separated list of colon-separated attribute-value pairs that contain the log-entry message and other information, for example:

```
"attribute1":"value","attribute2":"value","attribute3":"value"
```

15 NSP license administration

15.1 What is an NSP license?

15.1.1 Adding or updating an NSP license



CAUTION

Service Disruption

An NSP license file is digitally signed. If you rename or modify the license XML file, the NSP rejects the license and network management may be severely compromised.

You must not rename or modify the XML file inside a compressed license file.

The following procedures describe how to:

- apply a new or updated license to an NSP system
- view an NSP license
- change the licensed NSP Feature Packs
- add or remove NSP installation options

An NSP license defines the scope and type of an NSP deployment. The license information is in XML format; for information about viewing the license content, see [15.2 “How do I view an NSP license?”](#) (p. 363).



Note: You require root user privileges on the NSP deployer host to perform a license-management procedure in an NSP cluster.



Note: *release-ID* in a procedure step has the following format:

R.r.p-rel.version

where

R.r.p is the NSP release, in the form *MAJOR.minor.patch*

version is a numeric value

15.2 How do I view an NSP license?

15.2.1 Purpose

Perform this procedure to view the content of the NSP license file in an NSP cluster. An NSP license file contains information such as the following:

- basic license details such as creation time, NSP release, HA/DR support
- capacity counters for the License Points, or LPs
- list of the feature packages that the license enables

 **Note:** An NSP license file is compressed in a .zip file that may include other files.

15.2.2 Steps

1 _____

Log in as the root user on the NSP deployer host.

2 _____

Close the console window.

3 _____

If you do not know the license file location, perform the following steps.

1. Open the following file for viewing:

`/opt/nsp/NSP-CN-DEP-release-ID/NSP-CN-release-ID/config/nsp-config.yml`

2. Record the location of the license.zip file, which is the **file** value in the **license** subsection of the **nsp** section.

3. Close the file.

4 _____

Navigate to the directory that contains the license.zip file.

5 _____

To extract the NSP license file from license.zip, enter the following:

```
# unzip license.zip nspLicense.xml ↵
```

The nspLicense.xml file is uncompressed.

6 _____

Open the nspLicense.xml file for viewing using an XML or text editor.

7 _____

View the content, as required.

8 _____

Close the file.

9 _____

Close the console window.

END OF STEPS _____

15.3 How do I apply an NSP license?

15.3.1 Purpose

Perform this procedure to apply a new or updated NSP license to an NSP system.



CAUTION

Service disruption

Performing the procedure requires a restart of each NSP cluster, which is service-affecting.

You must perform the procedure only during a scheduled maintenance period.



Note: You must perform the procedure on each NSP cluster.



Note: In a DR deployment, you must perform the steps first on the standby NSP cluster.



Note: *release-ID* in a file path has the following format:

R.r.p-rel.version

where

R.r.p is the NSP release, in the form *MAJOR.minor.patch*

version is a numeric value

15.3.2 Steps

1

Log in as the root user on the NSP deployer host.

2

Open a console window.

3

If you do not know the license file location, perform the following steps.



Note: The location is configurable during NSP deployment; the default is `/opt/nsp`.

1. Open the following file for viewing:

`/opt/nsp/NSP-CN-DEP-release-ID/NSP-CN-release-ID/config/nsp-config.yml`

2. Record the location of the license.zip file, which is the **file** value in the **license** subsection of the **nsp** section.

3. Close the file.

4

Transfer the new license.zip file to the path recorded in [Step 3](#).

5

Enter the following to start the NSP cluster:



Note: If the NSP cluster VMs do not have the required SSH key, you must include the `--ask-pass` argument in the command, as shown in the following example, and are subsequently prompted for the root password of each cluster member:

```
nspdeployerctl --ask-pass install --config --deploy
```

```
# /opt/nsp/NSP-CN-DEP-release-ID/bin/nspdeployerctl install --config  
--deploy ↵
```

The NSP cluster starts, and the license is applied.

6

Close the console window.

END OF STEPS

Part IV: NSP disaster recovery

Overview

Purpose

This part of the guide describes the redundancy functions employed by DR NSP clusters, and by integrated or ancillary NSP components deployed outside NSP clusters.

Contents

| | |
|--|-----|
| Chapter 16, Disaster recovery for NSP clusters | 369 |
| Chapter 17, Disaster recovery for NSP components | 379 |

16 Disaster recovery for NSP clusters

16.1 What are the NSP cluster DR functions?

16.1.1 Description

The NSP disaster recovery (DR) function involves redundant NSP clusters in a warm standby configuration for fault tolerance in the event of a cluster failure. The following procedures describe how to control and manage NSP DR.

DR functions

The following NSP DR functions swap the primary and standby NSP cluster roles:

- failover—automatic DR role change initiated by the standby NSP cluster when a primary cluster failure is suspected
- switchover—manual DR operation that switches the NSP cluster roles

16.1.2 Failovers and switchovers

NSP DR failovers and switchovers are controlled by the ASM and role manager services, which run as the `nspos-asm-app` and `nsp-role-manager` pods in each DR NSP cluster. The standby role manager periodically checks the connectivity to the role manager in the primary NSP cluster.

In addition, the role manager monitors essential primary pods and services such as the following:

- ZooKeeper
- Kafka
- PostgreSQL
- `nspos-tomcat`
- `nsp-tomcat`
- Keycloak
- `prometheus-server`

If the role manager connectivity check fails for two minutes, or if an essential primary pod or service is down, the ASM triggers a failover to the standby cluster. The standby role manager and NSP cluster then assume the primary role. When the fault is resolved, the NSP automatically returns to normal operation with functional primary and standby clusters.

[16.3 “How do I identify the NSP cluster DR roles?” \(p. 372\)](#) describes how to display which role—primary or standby—is assigned to each NSP cluster. To restore the initial cluster roles after a failover, you perform a manual switchover, as described in [16.4 “How do I perform an NSP DR switchover?” \(p. 373\)](#).

i **Note:** After a failover or switchover, NSP functions restart processes that were interrupted. If downstream functions are not up yet, the restarted processes may fail. For example, if a network configuration deployment was auditing at the time of a failover, the audit will restart

when Infrastructure Configuration Management is up. If Network Intents is not back up yet when the audit is restarted, the audit will fail. The process can be restarted manually when the NSP has stabilized.

Disabling and enabling failovers

NSP DR failovers are enabled by default in a DR NSP deployment. If required, you can disable failovers to prevent disruption during a period of maintenance activity, as described in [16.6 “How do I disable NSP DR failovers?”](#) (p. 376)

[16.5 “How do I display the NSP DR failover setting?”](#) (p. 375) describes how to identify whether failovers are enabled.

i **Note:** The failover setting persists through an NSP software upgrade.

i **Note:** For maximum fault tolerance, failovers must be disabled only during a maintenance period, and re-enabled after the maintenance period, as described in [16.7 “How do I enable NSP DR failovers?”](#) (p. 377).

16.2 Workflow: prepare for an NSP DR switchover

16.2.1 Description

Before you perform an NSP DR switchover, you must ensure that the conditions are in place for a successful reversal of the primary and standby NSP cluster roles.

The following sequence of high-level actions describes how to ensure that the primary and standby NSP clusters are in the correct state for a successful DR switchover.

16.2.2 Stages

1 _____
Use the NSP UI to verify that there are no outstanding Critical or Major alarms against any NSP cluster.

2 _____
Verify that each pod listed in the following table is in the state shown.

| Pod | Primary cluster | Standby cluster |
|-------------------------------|-----------------|-----------------|
| nspos-zookeeper | Running | Running |
| nspos-postgresql ¹ | Running | Running |
| nspos-tomcat | Running | Running |
| nspos-prometheus | Running | Running |
| nspos-kafka | Running | n/a |
| nsp-tomcat | Running | Running |

| Pod | Primary cluster | Standby cluster |
|-----------------------------------|-----------------|-----------------|
| nspos-keycloak | Running | Running |
| nspos-oauth2-proxy | Running | Running |
| nspos-asm-app | Running | Running |
| nsp-role-mgr | Running | Running |
| nsp-file-service-app ² | Running | Running |

Notes:

1. Restarts during switchover to change role and functions
2. If present; pod not required in all deployment types

3

Perform [16.3 “How do I identify the NSP cluster DR roles?” \(p. 372\)](#) on each cluster; use the statusAll command option to ensure that each cluster has the correct role, which means that one cluster has the primary role, and the other the standby.

4

Perform [13.1 “How do I check NSP database synchronization?” \(p. 339\)](#) to ensure that the primary and standby databases are 100% synchronized.

5

Verify that the standby nsp-file-service-app pod can SSH to the primary nspos pod.

1. Enter the following as the root user on the NSP cluster host in the standby data center:

```
# kubectl exec -n $(kubectl get pods -A | awk  
'/nsp-file-service-app/ {print $1;exit}') nsp-file-service-app-0  
-it -- bash ↵
```

A root shell opens on the nsp-file-service-app pod.

2. Enter the following to attempt an SSH connection to the primary nspos pod:

```
# ssh -i /opt/nsp/apps/nsp-file-service-app/nspSSHCerts/hostcert -p  
8566 -o StrictHostKeyChecking=no address ↵
```

where *address* is the NSP cluster advertised address

If the command returns an error message, the SSH connection attempt has failed.

3. If the connection attempt fails, resolve the connection issue; you must not attempt a DR switchover unless the problem is resolved.

6

Close the open console windows.

16.3 How do I identify the NSP cluster DR roles?

16.3.1 Purpose

Perform this procedure to identify which NSP clusters in a DR deployment have the primary and standby roles.

i **Note:** You require root user privileges on the NSP cluster host in each data center.

i **Note:** If root access for remote operations is disabled in the NSP configuration, remote operations such as SSH and SCP as the root user are not permitted within an NSP cluster. Steps that describe such an operation as the root user must be performed as the designated non-root user with sudoer privileges.

For simplicity, such steps describe only root-user access.

i **Note:** A leading # character in a command line represents the root user prompt, and is not to be included in a typed command.

16.3.2 Steps

1

Log in as the root user on the NSP cluster host.

2

Enter the following:

```
# kubectl get pods -A | grep 'asm\|role' ↵
```

The following pods are listed:

- nsp-role-manager-*pod_ID*
- nspos-asm-app-*pod_ID*

3

Verify that each pod is in the Running state.

4

Record each *pod_ID* value for use in subsequent procedures.

5

To display the current cluster role, enter the following:

```
# kubectl exec -n $(kubectl get pods -A | awk '/nsp-role-manager/{print $1;exit}') -it $(kubectl get pods -A | awk '/nsp-role-manager/{print $2;exit}') -c role-manager -- /opt/nsp/os/rolemgr/bin/rmgrctl status ↵
```

If the cluster has the primary role, the following is displayed:

```
Site: cluster_name
```

```
Status: active
```

```
Since: timestamp
```

If the cluster has the standby role, the following is displayed:

```
Site: cluster_name
```

```
Status: standby
```

```
Since: timestamp
```

6

To display both cluster roles, enter the following:

 **Note:** The local cluster status is listed first.

```
# kubectl exec -n $(kubectl get pods -A | awk '/nsp-role-manager/{print $1;exit}') -it $(kubectl get pods -A | awk '/nsp-role-manager/{print $2;exit}') -c role-manager -- /opt/nsp/os/rolemgr/bin/rmgrctl statusAll ↵
```

Status information like the following is displayed; the output example indicates that the local cluster, which is listed first, is the primary cluster.

```
Site: cluster_name
```

```
Status: active
```

```
Since: timestamp
```

```
Site: cluster_name
```

```
Status: standby
```

```
Since: timestamp
```

END OF STEPS

16.4 How do I perform an NSP DR switchover?

16.4.1 Purpose



CAUTION

Service disruption

Performing this procedure causes a temporary loss of network visibility, which may be service-affecting.

You must perform the procedure only with the assistance of technical support during a scheduled maintenance period.

Perform this procedure to manually switch the primary and standby NSP cluster roles.

 **Note:** You require root user privileges on the NSP cluster host in each data center.



Note: A leading # character in a command line represents the root user prompt, and is not to be included in a typed command.

16.4.2 Steps

1

Perform [16.3 “How do I identify the NSP cluster DR roles?” \(p. 372\)](#) to identify each NSP cluster role.

2

Log in as the root user on a VM in the standby NSP cluster.

3

Open a console window.

4

Enter the following:

```
# kubectl exec -n $(kubectl get pods -A | awk '/nsp-role-manager/{print $1;exit}') -it $(kubectl get pods -A | awk '/nsp-role-manager/{print $2;exit}') -c role-manager -- /opt/nsp/os/rolemgr/bin/rmgrctl toActive ↵
```

The standby cluster assumes the primary role.

5

Enter the following periodically to display the status of the clusters as the roles change:

```
# kubectl exec -n $(kubectl get pods -A | awk '/nsp-role-manager/{print $1;exit}') -it $(kubectl get pods -A | awk '/nsp-role-manager/{print $2;exit}') -c role-manager -- /opt/nsp/os/rolemgr/bin/rmgrctl statusAll ↵
```

Output like the following is displayed when the role changes are complete:

```
Site: primary_cluster_name  
Status: active  
Since: timestamp  
Site: standby_cluster_name  
Status: standby  
Since: timestamp
```

6

When the role changes are complete, close the open console windows.

END OF STEPS

16.5 How do I display the NSP DR failover setting?

16.5.1 Purpose

Perform this procedure to identify whether failovers are enabled in a DR NSP deployment.

i **Note:** You require root user privileges on the NSP cluster host in each data center.

i **Note:** A leading # character in a command line represents the root user prompt, and is not to be included in a typed command.

16.5.2 Steps

1 _____
Log in as the root user on the NSP cluster host in either data center.

2 _____
Open a console window.

3 _____
Enter the following:

```
# kubectl exec -n $(kubectl get pods -A | awk '/nspos-asm/ {print $1;exit}') -it $(kubectl get pods -A | awk '/nspos-asm/ {print $2;exit}') -c nspos-asm-app -- /opt/nsp/os/asm/bin/asmctl autoFailoverStatus ↵
```

The following is displayed:

```
Current Auto-failover is: value
```

where *value* is one of the following:

- True—failovers are enabled
- False—failovers are disabled

4 _____
Close the console window.

END OF STEPS _____

16.6 How do I disable NSP DR failovers?

16.6.1 Purpose

Perform this procedure to disable the failover function in a DR NSP deployment.

i **Note:** Disabling the NSP failover function is intended to be a temporary measure for system maintenance purposes only. It is strongly recommended that you re-enable failovers after any maintenance that requires failovers to be disabled.

i **Note:** You require root user privileges on the NSP cluster host in a data center.

i **Note:** A leading # character in a command line represents the root user prompt, and is not to be included in a typed command.

16.6.2 Steps

1 _____

Log in as the root user on the NSP cluster host in either data center.

2 _____

Open a console window.

3 _____

Enter the following:

```
# kubectl exec -n $(kubectl get pods -A | awk '/nspos-asm/ {print $1;exit}') -it $(kubectl get pods -A | awk '/nspos-asm/ {print $2;exit}') -c nspos-asm-app -- /opt/nsp/os/asm/bin/asmctl  
disableAutoFailover ↵
```

The following is displayed:

```
Auto-failover successfully disabled
```

4 _____

Perform [16.3 “How do I identify the NSP cluster DR roles?”](#) (p. 372) to verify that the cluster roles are unchanged.

5 _____

Close the open console windows.

END OF STEPS _____

16.7 How do I enable NSP DR failovers?

16.7.1 Purpose

Perform this procedure to enable the failover function in a DR NSP deployment.

i **Note:** You require root user privileges on the NSP cluster host in each data center.

i **Note:** A leading # character in a command line represents the root user prompt, and is not to be included in a typed command.

16.7.2 Steps

1 _____
Log in as the root user on the NSP cluster host in either data center.

2 _____
Open a console window.

3 _____
Enter the following:

```
# kubectl exec -n $(kubectl get pods -A | awk '/nspos-asm/ {print $1;exit}') -it $(kubectl get pods -A | awk '/nspos-asm/ {print $2;exit}') -c nspos-asm-app -- /opt/nsp/os/asm/bin/asmctl enableAutoFailover ↵
```

The following is displayed:
Auto-failover successfully enabled

4 _____
Perform [16.3 “How do I identify the NSP cluster DR roles?”](#) (p. 372) to verify that the cluster roles are unchanged.

5 _____
Close the open console windows.

END OF STEPS _____

17 Disaster recovery for NSP components

17.1 What are the NSP component DR functions?

17.1.1 Overview

In a DR NSP deployment, ancillary or optional NSP components deployed outside the NSP clusters have different redundancy mechanisms. In some scenarios, administrative action may be required to restore redundant operation, or to realign the component roles in a data center after a failed component is restored to operation:

- NSP auxiliary database clusters—see [17.2.1 “Auxiliary database geographic redundancy” \(p. 379\)](#)
- NSP Flow Collectors and Flow Collector Controllers—automatic switch to standby; no administrative action required
- NFM-P—see [17.4 “What is classic management redundancy?” \(p. 381\)](#)

17.2 What is auxiliary database redundancy?

17.2.1 Auxiliary database geographic redundancy

A geographically redundant, or geo-redundant, auxiliary database has one cluster of one, or three or more, auxiliary database stations in each NSP data center. The cluster that is designated the primary cluster processes transactions; the other cluster acts as a warm standby in the event of a primary cluster failure.

The primary cluster replicates the incremental database content changes on the standby cluster every 30 minutes. Because the primary database updates are not immediately replicated, some data loss may occur under failure or switchover conditions.

Auxiliary database failovers

An auxiliary database failover is non-revertive; a manual switchover is required to restore the former cluster roles when the failed cluster returns to service; see [17.3 “How do I perform an auxiliary database switchover?” \(p. 380\)](#) for information.

NSP Analytics uses the primary auxiliary database as a data source. In the event of a primary auxiliary database cluster failure and resulting failover to the standby cluster, no operator intervention is required to restore Analytics functions, which automatically begin to use the new primary auxiliary database cluster.

17.3 How do I perform an auxiliary database switchover?

17.3.1 Purpose



CAUTION

Data Loss

Performing an auxiliary database switchover may result in an data-collection interruption of up to 30 minutes.

Ensure that you perform the switchover directly after the completion of the most recent copy-cluster operation, as described in the procedure.

Perform this procedure to switch the primary and standby roles of a geo-redundant auxiliary database.

17.3.2 Steps

1 _____

Log in to a station that has access to the NSP system.

2 _____

Open a console window.

3 _____

A copy-cluster operation is invoked every 30 minutes to replicate the recent data from the primary to the standby auxiliary database cluster.

You must identify the status of the most recent copy-cluster operation in order to determine when to perform the switchover.

Issue the following RESTCONF API call:



Note: In order to issue a RESTCONF API call, you require a token; see the My First NSP API Client tutorial on the [Network Developer Portal](#) for information.

GET `https://address/restconf/data/auxdb:/auxdb-agent`

where *address* is the NSP advertised address

The auxiliary database cluster status is displayed; a copy-cluster operation is in progress when the status is RUNNING, and is complete when the status is SUCCESS.

4 _____

Review the status information; if a copy-cluster operation is in progress, return to [Step 3](#); otherwise, identify the most recent copy-cluster completion time.



Note: To minimize data loss during a switchover, you must perform the switchover as soon as possible after the completion of a copy-cluster operation.

5 _____
Plan to perform the auxiliary database switchover as soon as possible after the completion of a copy-cluster operation.

6 _____
At the time planned in [Step 5](#), perform the switchover by issuing the following RESTCONF API call:

```
POST https://address/restconf/data/auxdb:/clusters/cluster=cluster_ID/activate
```

where

address is the NSP advertised address

cluster_ID is the target-cluster value in the [Step 3](#) command output

The roles reverse; the former standby cluster assumes the primary role.

7 _____
Close the console window.

END OF STEPS _____

17.4 What is classic management redundancy?

17.4.1 Redundancy functions

NFM-P system redundancy is initially configured during system deployment. You use the NFM-P GUI, or scripts on a main server station, to perform the following redundancy functions:

- Check the main server and database redundancy status.
- Manually switch the primary and standby main server roles.
- Enable or disable automatic database realignment.
- Reinstantiate the former primary database as the standby database.

You can configure the following redundancy parameters to specify how an NFM-P system manages a loss of connection to the managed NEs; contact technical support for more information:

- the number of elapsed seconds that constitute a loss of connectivity
- how often a main server refreshes the list of managed NEs
- the minimum number of NEs that must respond to a connectivity check

17.5 What are the NFM-P system redundancy models?

17.5.1 Overview



CAUTION

Service Disruption

It is recommended that you deploy the primary server and database in the same geographical location and LAN.

This results in increased NFM-P system performance and fault tolerance.

A redundant NFM-P system provides greater fault tolerance by ensuring that there is no single point of software failure in the NFM-P management network. A redundant system consists of the following components:

- primary and standby main servers
- primary and standby main databases

The current state of a component defines the primary or standby role of the component. The primary main server actively manages the network and the primary database is open in read/write mode. When a standby component detects a primary component failure, it automatically changes roles from standby to primary. You can also change the role of a component using the NFM-P client GUI or a CLI script.

The NFM-P supports collocated and distributed system redundancy. A collocated system requires two stations that each host a main server and database. A distributed system requires four stations that each host a main server or database. Each main server and database is logically independent, regardless of the deployment type.

The primary and standby main servers communicate with the redundant databases and periodically verify server redundancy. If the standby server fails to reach the primary server within 60s, the standby server becomes a primary server. See [17.7 “How do I respond to NFM-P redundancy failures?” \(p. 394\)](#) for information about various NFM-P redundancy failure scenarios.

A main database uses the Oracle DataGuard function to maintain redundancy. During a redundant NFM-P installation or upgrade, the Oracle DataGuard synchronization level is set to real-time apply, which ensures that the primary and standby databases are synchronized.

Figure 17-1 Collocated redundant NFM-P deployment

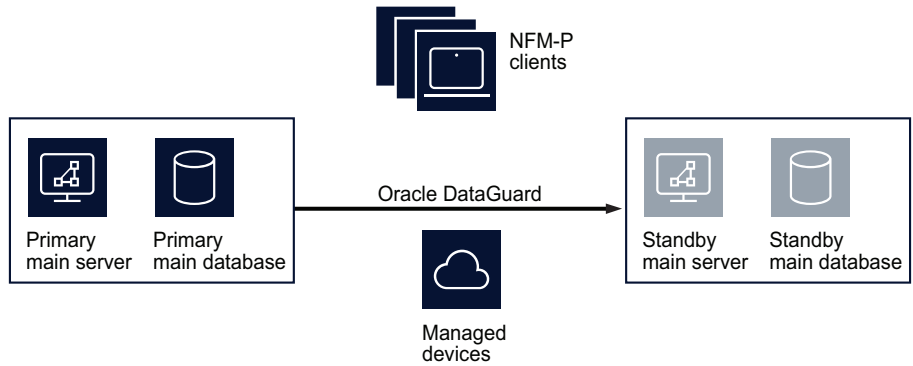

17896

Figure 17-2 Distributed redundant NFM-P deployment

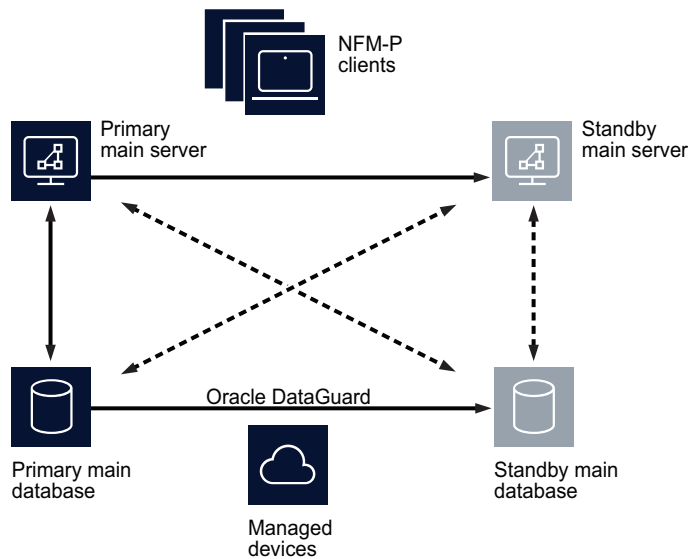

17897

A main server role change is called a server activity switch. An automatic database role change is called a failover; a manual database role change is called a switchover.

A typical redundant NFM-P system has a primary server and database in a geographically separate facility from the standby server and database facility. To ensure that the primary components are in

the same LAN after an activity switch or failover, you can configure automatic database realignment during a main server installation or upgrade. See [17.6.6 “Automatic database realignment” \(p. 391\)](#) for more information.

The NFM-P GUI, browser, and XML API clients must always communicate with the current primary main server. After a server activity switch or switchover:

- The GUI clients automatically connect to the new primary main server, which is the former standby.
- The XML API and browser clients do not automatically connect to the new primary main server; you must redirect each browser and XML API client to the new primary main server.

The following general conditions apply to NFM-P system redundancy:

- The main servers and databases must each be redundant. For example, you cannot have redundant servers and a standalone database.
- The network that contains a redundant NFM-P system must meet the latency and bandwidth requirements described in the *NSP NFM-P Planning Guide*.

Note: To provide hardware fault tolerance in addition to software redundancy, it is recommended that you use redundant physical links between the primary and standby servers and databases to ensure there is no single point of network or hardware failure.

- The server and database stations require the same OS version and patch level.
- The server stations require identical disk layouts and partitioning.
- The database stations require identical disk layouts and partitioning.
- Only the nsp user on a main server station can perform a server activity switch.
- The following users can perform a database switchover:
 - nsp user on a main server station
 - NFM-P GUI user with update or execute permissions on the following classes:
 - db.DatabaseManager.switchover
 - db.DatabaseManager.reinstantiateStandby
 - NFM-P GUI user with the admin scope of command role

17.5.2 Auxiliary server redundancy

NFM-P auxiliary servers are optional servers that extend the network management processing engine by distributing server functions among multiple stations. An NFM-P main server controls task scheduling and sends task requests to auxiliary servers. Each auxiliary server is installed on a separate station, and responds to processing requests only from the current primary main server in a redundant system.

When an auxiliary server cannot connect to the primary main server or database, it re-initializes and continues trying to connect until it succeeds or, in the case of a database failover, until the main server directs it to the peer database.

After startup, an auxiliary server waits for initialization information from a main server. An auxiliary server restarts if it does not receive all required initialization information within five minutes.

 **Note:** NFM-P system performance may degrade when a main server loses contact with a number of auxiliary servers that exceeds the number of Preferred auxiliary servers.

When an auxiliary server fails to respond to a primary main server, the main server tries repeatedly to establish communication before it generates an alarm. The alarm clears when the communication is re-established.

Auxiliary server types

The auxiliary servers in an NFM-P system are specified in each main server configuration, which includes the address of each auxiliary server in the system, and the auxiliary server type, which is one of the following:

- Preferred—processes requests under normal conditions
- Reserved—processes requests when a Preferred auxiliary server is unavailable
- Remote Standby—unused by the main server; processes requests only from the peer main server, and only when the peer main server is operating as the primary main server

If a Preferred auxiliary server is unresponsive, the main server directs the requests to another Preferred auxiliary server, if available, or to a Reserved auxiliary server. When the unresponsive Preferred auxiliary server returns to service, the main server reverts to the Preferred auxiliary server and stops sending requests to any Reserved auxiliary server that had assumed the Preferred workload.

An auxiliary server that is specified as a Remote Standby auxiliary server is a Preferred or Reserved auxiliary server of the peer main server. The Remote Standby designation of an auxiliary server in a main server configuration ensures that the main server does not use the auxiliary server under any circumstances. Such a configuration may be required when the network latency between the primary and standby main servers is high, for example, when the NFM-P system is geographically dispersed.

Alternatively, if all main and auxiliary servers are in the same physical facility and the network latency between components is not a concern, no Remote Standby designation is required, and you can apply the Preferred and Reserved designations based on your requirements. For example, you may choose to configure a Preferred auxiliary server of one main server as the Reserved auxiliary server of the peer main server, and a Reserved auxiliary server as the Preferred of the peer main server.

17.5.3 IPDR file transfer redundancy

The NFM-P can forward collected AA accounting and AA Cflowd statistics in IPDR format to redundant target servers for retrieval by OSS applications. For additional redundancy, you can configure multiple NSP Flow Collectors to forward AA Cflowd statistics data to the target servers. Such a configuration provides a high degree of fault tolerance in the event of an NFM-P component failure.

AA accounting statistics collection

An NFM-P main or auxiliary server forwards AA accounting statistics files to the target servers specified in an IPDR file transfer policy. An IPDR file transfer policy also specifies the file transfer type and user credentials, and the destination directory on the target server. See [17.16 “How do I configure the IPDR file-transfer policy?”](#) (p. 411) for configuration information.

Each IPDR file is transferred as it is closed. A file that cannot be transferred is retained and an error is logged. Corrupt files, and files that cannot be created, are stored in a directory named “bad” below the specified destination directory on the server.

i **Note:** A main or auxiliary server does not retain successfully transferred IPDR files; each successfully transferred file is deleted after the transfer.

After you configure the IPDR file transfer policy, the main or auxiliary server that collects AA accounting statistics forwards the statistics files to the primary transfer target named in the policy. If the server is unable to perform a file transfer, for example, because of an unreachable target, invalid user credentials, or a disk-capacity issue, the main or auxiliary server attempts to transfer the files to the alternate target, if one is specified in the policy. Statistics data is sent to only one target; no statistics data is duplicated on the target servers.

AA Cflowd statistics collection

In an NFM-P system that uses NSP Flow Collectors, each collector transfers AA Cflowd statistics files to a target server for OSS retrieval.

You can specify the same or a different target for each NSP Flow Collector. For example, to ensure minimal data loss in the event of a collector or target failure, you can configure two collectors to:

- retrieve the same AA Cflowd statistics from one group of NEs
- send the statistics files to different targets

In such a configuration, if files are absent from a target, or the target is unreachable, the files are available from the other target.

See the *NSP Installation and Upgrade Guide* for information about configuring NSP Flow Collector functions.

17.6 What are the NFM-P redundancy functions?

17.6.1 Overview

Figure 17-3 NFM-P redundancy role-change functions

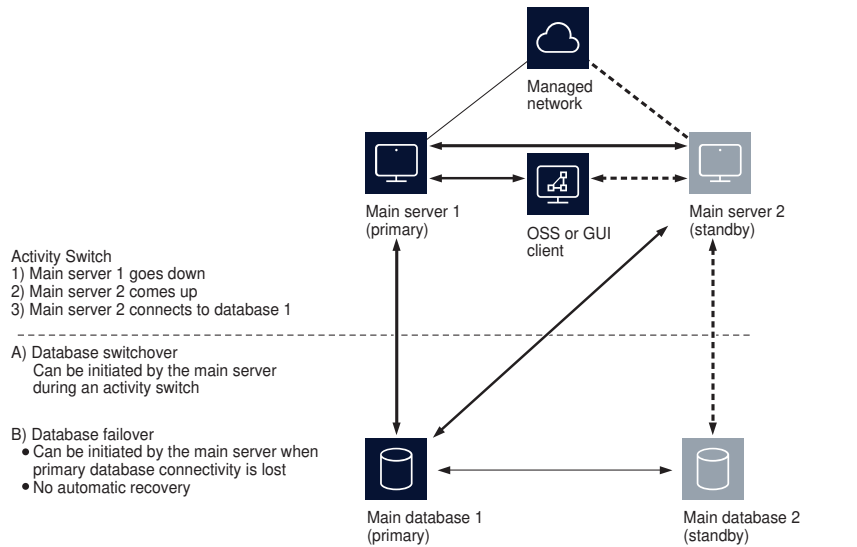

17.6.2 Server activity switches

The standby server initiates an automatic server activity switch when it cannot communicate with the primary server. An NFM-P administrator can perform a manual server activity switch, which is typically a planned server maintenance or test operation.

Note: For security reasons, you cannot use an NFM-P GUI or XML API client to perform a server activity switch.

Figure 17-4 Server and database roles before server activity switch

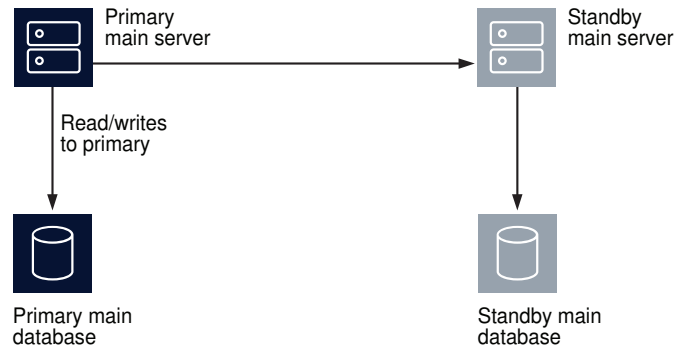

17840

The NFM-P raises alarms when a server activity switch is initiated. During the activity switch, the main servers do not process SNMP traps, attempt to synchronize NEs, or collect statistics. Auxiliary servers process outstanding requests, but do not communicate with a main server.

Figure 17-5 Server and database roles after server activity switch

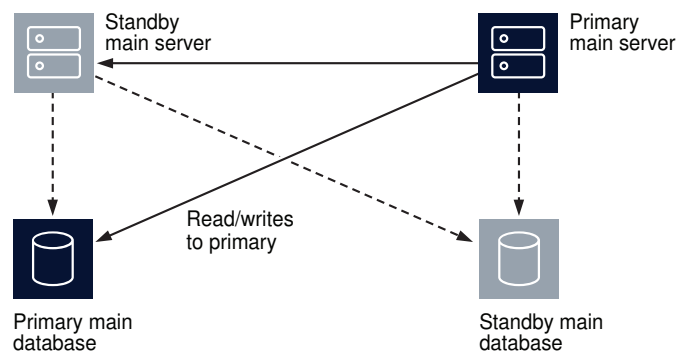

17893

After a server activity switch:

- If automatic database realignment is enabled, the new primary main server performs a database switchover.
- All browser and XML API clients require redirection to the new primary main server.
- The new primary server establishes communication and synchronizes information with the auxiliary servers.
- The auxiliary servers exchange information with the new primary server; no auxiliary servers exchange information with the former primary server.
- The Preferred or Reserved state of each auxiliary server changes, depending on the configuration of the new primary server.

- The new primary server attempts to redeploy the client requests that the former primary server did not complete before the activity switch.

17.6.3 Database switchovers

An NFM-P administrator directs a main server to initiate a database switchover.

Figure 17-6 Server and database roles before database switchover

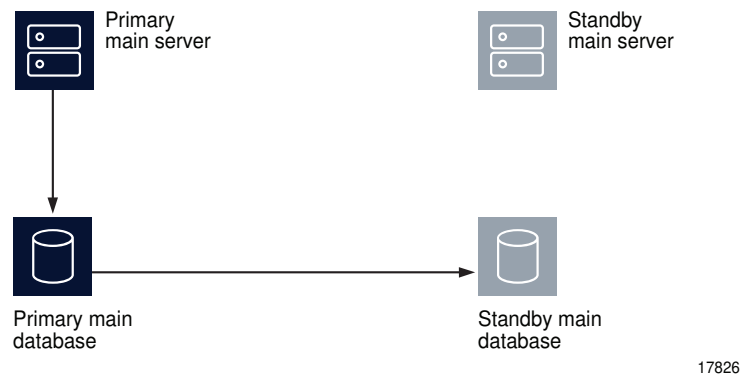
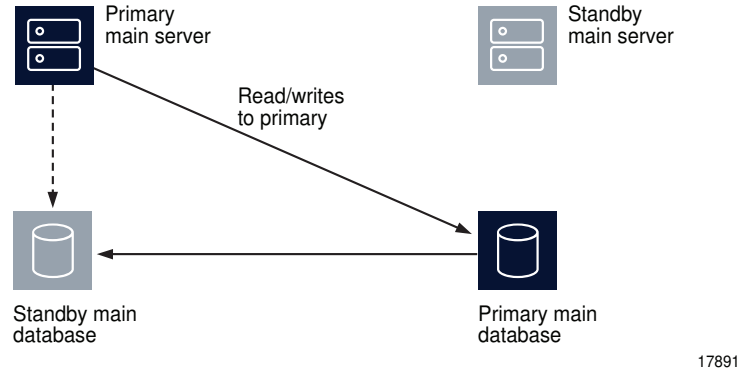

Figure 17-7 Server and database roles after database switchover



The following occurs after a successful database switchover:

- The primary server connects to the new primary database.
- Archive logging begins on the new primary database.
- The primary server directs each auxiliary server to use the new primary database.

When a database switchover fails, the primary and standby database roles do not change. No automatic database realignment occurs as a result of a switchover.

17.6.4 Database failovers

The main database failover function is enabled by default. A failover occurs when a main server cannot communicate with the primary database, but can communicate with the standby database and the managed NEs. When this happens, the main server directs the standby database to become the primary database.

A database failover occurs only if the following conditions are true.

- The standby database is configured, operational, and reachable.
- The main server can communicate with the managed NEs.

Figure 17-8 Server and database roles before database failover

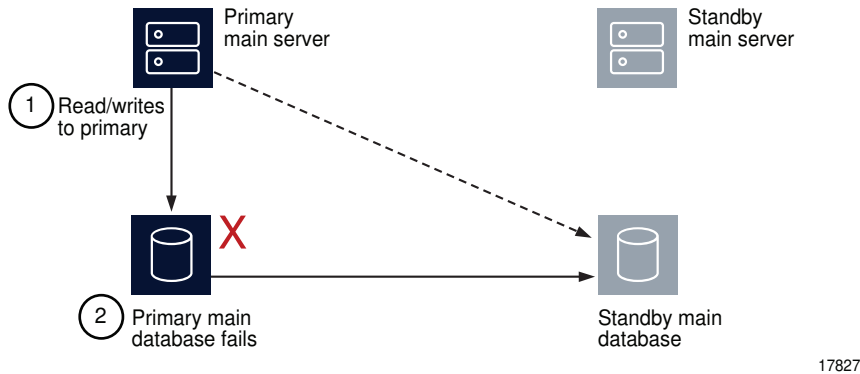
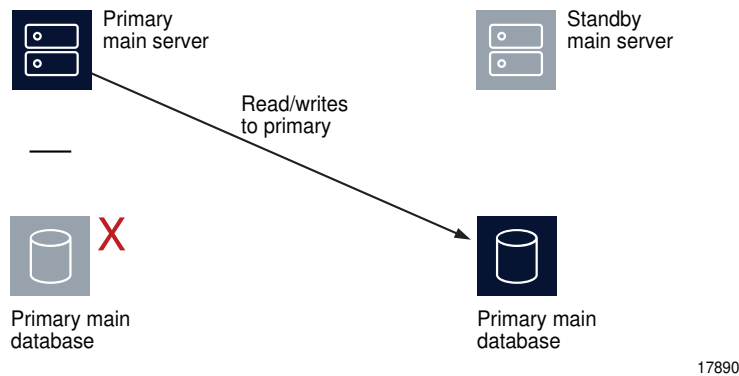

Figure 17-9 Server and database roles after database failover



When a database failover fails, the primary server tries again to communicate with the primary database. If the primary database remains unavailable, the primary server tries again to initiate a failover.

Note: During a database failover, a network management outage occurs; the GUI clients can

monitor the failover, but cannot perform configuration activities.

Note: After a successful failover, database redundancy is not available until the new primary database is reinstated as the standby database on the former primary database station. See 17.6.5 “Re-establishing database redundancy” (p. 390) for more information.

17.6.5 Re-establishing database redundancy

After a failover, the former primary database is no longer part of the redundant configuration. To re-establish database redundancy, you must reinitiate the former primary database as the new standby database. You can do this only when the failed database station is restored to full operation and has a functional proxy port. See 22.20 “How do I reinitiate the main database from the client GUI?” (p. 680) and 22.21 “How do I reinitiate the main database from a CLI?” (p. 681) for information about how to reinitiate a database.

Figure 17-10 Server and database roles after database reinitiation

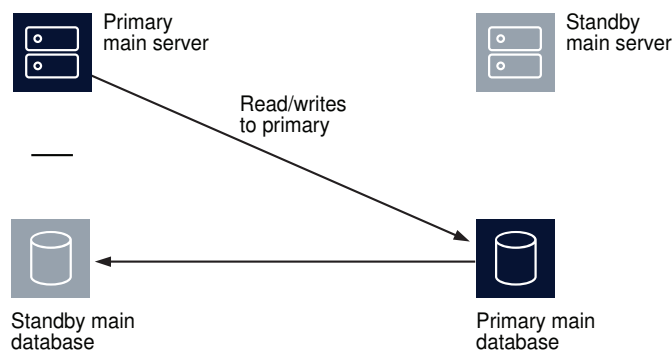

18562

Automatic database reinitiation

You can configure the NFM-P to automatically reinitiate the former primary database as the new standby database. Automatic database reinitiation occurs only in the event of a database failover. When the function is enabled, the NFM-P attempts an automatic reinitiation every 60 minutes by default. You can enable automatic database reinitiation during a main server installation or upgrade. See the *NSP Installation and Upgrade Guide* for information about enabling and configuring automatic database reinitiation.

17.6.6 Automatic database realignment

In a redundant NFM-P system that is geographically dispersed, the primary main server and database may be in separate LANs or WANs after an activity switch or failover. The network latency that this introduces can affect NFM-P system performance. Automatic database realignment is an optional mechanism that attempts to ensure that each main server uses the local database.

The database with which a main server tries to align itself is called the preferred database of the main server. An operator enables automatic database realignment and specifies the preferred database during NFM-P server installation, or during server configuration after installation.

i **Note:** For automatic database alignment to work, you must enable it and specify a preferred database on each main server in a redundant NFM-P system.

When a primary server starts, it verifies that the primary database is the preferred database. If the primary database is not the preferred database, the server performs a database switchover to reverse the primary and standby database roles. If the switchover is successful, the main servers and databases in the NFM-P system are aligned. If the switchover fails, each database reverts to the former role, and the main server generates an alarm about the failed switchover.

When you perform a database switchover and automatic database realignment is enabled, the primary server does not attempt database realignment. A switchover is a manual operation that is considered to be a purposeful act.

Performing a server activity switch when automatic database realignment is enabled triggers a database switchover.

17.6.7 Redundancy function summary

Table 17-1 Redundancy functions, main server

| Function | Notes |
|---|--|
| <p>Automatic server activity switch</p> <p>An automatic activity switch occurs when the primary server cannot communicate with the standby server, and involves the following sequence of events.</p> <ul style="list-style-type: none"> • The standby server cannot communicate with the primary server within 60 seconds, or the primary server cannot communicate with the managed network. • The standby server performs an activity switch to become the new primary server. The activity switch occurs only if the standby server can communicate with the managed network. • If automatic database realignment is enabled, the new primary server attempts a database switchover. • The new primary server connects to the primary database and manages the network. • The new primary server and the auxiliary servers synchronize the outstanding request information. | <p>During an activity switch, each browser client and XML API client loses connectivity with the primary main server.</p> <p>During an activity switch, a main server does not process SNMP traps from the network, and no NE re-synchronizations occur.</p> <p>The auxiliary servers continue to process outstanding requests, and synchronize the request information with the new primary server after the activity switch.</p> <p>When the communication failure is resolved, you must re-open each browser client, and redirect each XML API client to the new primary main server.</p> |
| <p>Manual server activity switch</p> <p>A manual activity switch is typically performed for maintenance or testing during a scheduled period of low activity, and involves the following sequence of events.</p> <ul style="list-style-type: none"> • An NFM-P administrator initiates the activity switch on the primary server. • The standby server performs an activity switch to become the new primary server. • The new primary server connects to the primary database and manages the network. • The new primary server and the auxiliary servers synchronize the request information. • If automatic database realignment is enabled, the new primary server attempts a database switchover. | |

Table 17-2 Redundancy functions, main database

| Function | Notes |
|---|--|
| <p>Database switchover</p> <p>A database switchover is a manual operation that reverses the primary and standby database roles, for example, for primary database maintenance, or to realign database roles with database stations after a server activity switch.</p> <p>A switchover can occur only when the primary and standby databases are functioning correctly and can communicate with each other.</p> <p>A database switchover involves the following sequence of events.</p> <ul style="list-style-type: none"> • An NFM-P administrator initiates the switchover on a primary or standby server. • The main server asks each auxiliary server to release all database connections. The switchover fails if all database connections are not released within 15 minutes. • The main server directs the standby database to become the primary database. • The main server fully synchronizes information with the new primary database. <p>See 17.13 "How do I perform a main database switchover using the NFM-P client GUI?" (p. 406) for information about performing a database switchover.</p> | <p>No automatic database realignment occurs after a database switchover.</p> |
| <p>Database failover</p> <p>A database failover is an automatic operation that changes the standby database into a primary database when the original primary database is unreachable, for example, because of a power disruption on the primary database station.</p> <p>A database failover involves the following sequence of events.</p> <ul style="list-style-type: none"> • No main server can communicate with the primary database within a period that is 2 min by default. • The primary main server directs the standby database to become the primary database. • If automatic database realignment is enabled and the primary server and database are not aligned, the primary server performs an activity switch. • The primary server directs each auxiliary server to connect to the new primary database. • The main server restarts after a failover. | <p>When the primary server detects a communication failure with the primary or standby database:</p> <ul style="list-style-type: none"> • The GUI clients are informed that the database is not reachable. • A network management outage begins; the GUI clients can monitor the failover, but cannot perform configuration activities. <p>After the cause of the communication failure is resolved, the GUI clients are notified that the database is reachable, and the network management outage ends.</p> <p>After the failover, you must reinstantiate the former primary database as the new standby database to restore database redundancy.</p> <p>Note: If automatic database reinstatement is enabled, the NFM-P automatically attempts to reinstantiate the former primary database.</p> |
| <p>Re-establishing database redundancy</p> <p>Re-establishing database redundancy after a database failure requires database reinstatement to replicate the current primary database as the standby database.</p> <p>After a failover, the former primary database is not available for redundancy until an operator or the automatic database reinstatement function reinstates it as the new standby database.</p> <p>See 22.20 "How do I reinstantiate the main database from the client GUI?" (p. 680) and 22.21 "How do I reinstantiate the main database from a CLI?" (p. 681) for information about re-establishing database redundancy after a failover.</p> | <p>The following conditions must be met before you can re-establish database redundancy.</p> <ul style="list-style-type: none"> • The failover completes successfully. • The station that contains the former primary database is operational. • The former primary database proxy port is configured and in service. |

17.7 How do I respond to NFM-P redundancy failures?

17.7.1 Overview

The following describe the NFM-P actions in response to various types of redundancy failures.

- **Primary server loses contact with primary database**

If the standby server can communicate with the primary database and the managed NEs, the primary server performs a server activity switch. No database failover occurs.

If automatic database realignment is enabled, the new primary server performs a database switchover.
- **Primary server loses contact with managed NEs**

If the standby server can communicate with the primary database and the managed NEs, the primary server performs a server activity switch.

If automatic database realignment is enabled, the new primary server performs a database switchover.
- **Primary server loses contact with primary database and managed NEs**

If the standby server can communicate with the primary database and the managed NEs, the primary server performs a server activity switch. No database failover occurs.

If automatic database realignment is enabled, the new primary server performs a database switchover.
- **Primary server loses contact with primary database, managed NEs, and standby server**

The standby server activates to become the new primary server, and if automatic database realignment is enabled, initiates a database switchover.
- **Both servers lose contact with primary database**

The primary server initiates a database failover, and if automatic database realignment is enabled, also initiates a server activity switch.
- **Both servers lose contact, primary server and database can communicate**

The primary server and database remain the primary server and database. The NFM-P raises an alarm about the server communication failure.
- **Both servers lose contact with managed NEs**

If the primary and standby servers can each communicate with the preferred database, no server activity switch or database failover occurs. The NFM-P raises a reachability alarm against each NE in the network.
- **Both servers lose contact with primary database and managed NEs**

If the primary and standby servers can communicate with each other, no server activity switch or database failover occurs. However, the NFM-P system is unavailable; manual intervention such as a database failover is required.
- **Both servers fail, primary database isolated, standby database operational**

When both servers return to operation, the servers cannot connect to the primary database. Because the state of the standby database is unknown, no database failover occurs; manual intervention such as a database switchover is required.

17.7.2 Collocated system, primary station unreachable

Figure 17-11 Primary server and database station down, collocated system

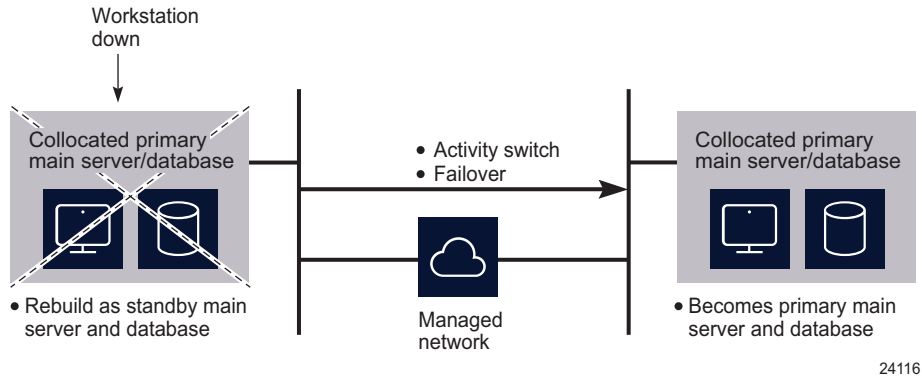

The following occur when the primary station becomes unresponsive:

- The standby server and database become the primary server and database.
- Redundancy is restored when the former primary station returns to service as the standby station.

17.7.3 Distributed system, primary server unreachable

Figure 17-12 Primary server unreachable, distributed system

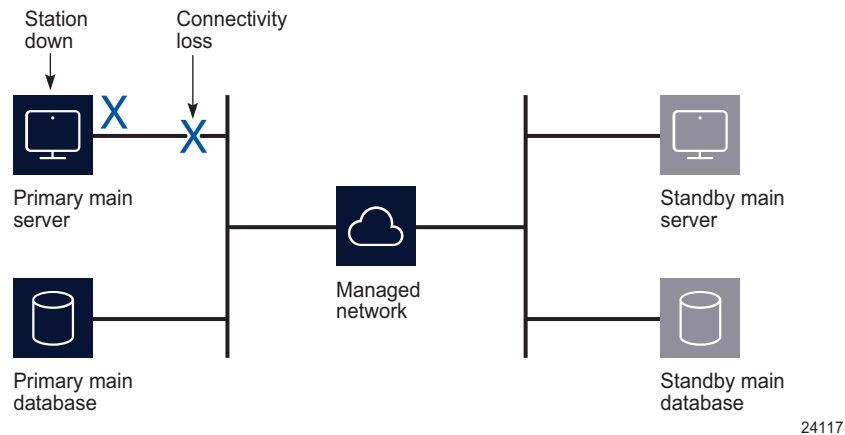

The following occur when the primary station becomes unresponsive:

- The standby server detects the connectivity loss and becomes the primary server.

- The new primary main server raises alarms about the unavailability of the former standby, and about the activity switch.
- If automatic database realignment is enabled, the new primary server initiates a database switchover.
- When connectivity is restored, the former primary server assumes the standby server role.

17.7.4 Distributed system, standby server unreachable

Figure 17-13 Standby server unreachable, distributed system

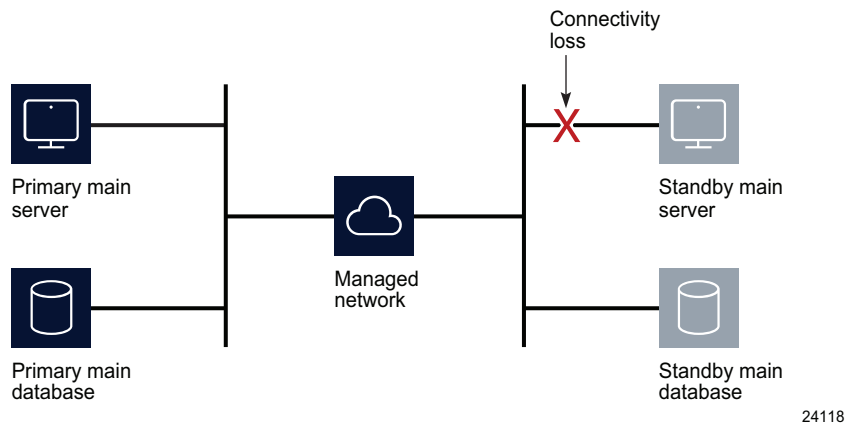

The following occur when the standby station becomes unresponsive:

- The standby server interprets the primary server unresponsiveness as a primary server failure, so attempts to assume the primary server role.
- The primary server generates an alarm to indicate that the standby server is down.
- When the reachability is restored, the standby server resumes the standby role and the alarm clears.

17.7.5 Distributed system, managed network unreachable by primary side

Figure 17-14 Network failure on primary side, distributed system

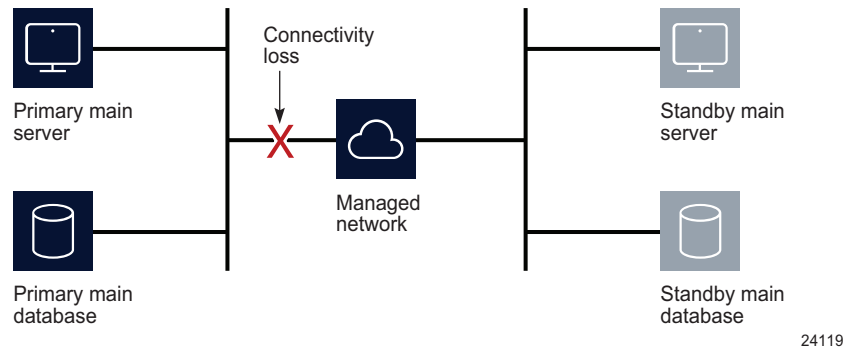

The following occur after the connectivity loss is detected:

- The initial primary server continues to operate as a primary server.
- The initial primary server generates an alarm about the standby server unavailability, and a reachability alarm against each NE in the network.
- Each GUI client displays the standby server status as Down.
- The standby server becomes a primary server.

i **Note:** You can eliminate a single point of hardware or network failure by using redundant interfaces and redundant physical network paths. See the *NSP NFM-P Planning Guide* for more information.

17.7.6 Split complex

A split complex is a scenario in which both servers in a collocated or distributed system lose contact, but each server can communicate with the preferred database, as shown in the following figure.

Figure 17-15 Split complex, collocated or distributed system

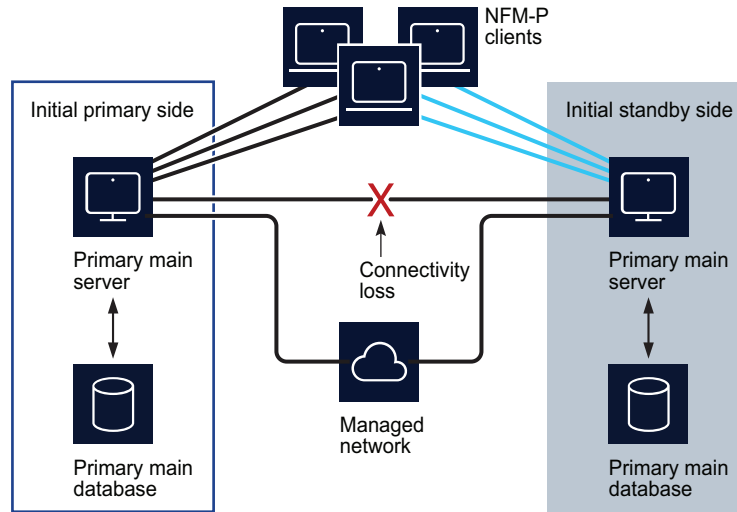

24120

The following occur after the connectivity loss is detected:

- The initial primary server and database roles do not change; the initial primary server continues to manage the network. The client sessions are not interrupted.
- The primary server raises an alarm about the communication failure.
- The standby server and database switch roles to become a second primary server and database.
- New clients connect to the initial primary server; however, if a client explicitly tries to connect to the second primary server, a session is established.
- When the servers regain contact:
 - If the network disruption also isolates one server from the managed NEs, the other server and database remain the primary.
 - Otherwise, the server that has currently held the primary role for longer remains the primary, and the other server and database assume the standby role,

17.8 Workflow: manage NFM-P redundancy

17.8.1 Stages

1

As required, perform server activity switches and database switchovers.

a.

For main servers:

1. View the status of the primary and secondary servers to verify the redundancy status is Up; see [17.9 “How do I view the NFM-P system redundancy status?”](#) (p. 399) .
2. If required, verify the redundancy status of the NFM-P auxiliary server; see [17.10 “How do I view the NFM-P auxiliary server status?”](#) (p. 402) .
3. Perform a manual activity switch to reverse the primary and standby roles; see [17.11 “How do I perform a server activity switch?”](#) (p. 404).
4. Validate the updated redundancy status; see [17.9 “How do I view the NFM-P system redundancy status?”](#) (p. 399).

b.

For main databases:

1. View the redundancy status of the primary and secondary database to verify the redundancy status is Up; see [17.9 “How do I view the NFM-P system redundancy status?”](#) (p. 399).
2. As required, specify the behavior of how database switchovers are executed; see [17.12 “How do I configure main database switchover behavior?”](#) (p. 405).
3. As required, perform a database switchover; see [17.13 “How do I perform a main database switchover using the NFM-P client GUI?”](#) (p. 406) or [17.14 “How do I perform a main database switchover using a CLI script?”](#) (p. 407).
4. As required, enable or disable automatic database realignment; see [17.15 “How do I enable or disable automatic database realignment?”](#) (p. 408).
5. Validate the updated redundancy status; see [17.9 “How do I view the NFM-P system redundancy status?”](#) (p. 399).

2

After a main database failover, re-establish redundancy between the standby and primary databases; see [22.20 “How do I reconstitute the main database from the client GUI?”](#) (p. 680) and [22.21 “How do I reconstitute the main database from a CLI?”](#) (p. 681).

17.9 How do I view the NFM-P system redundancy status?

17.9.1 Steps

1

View the Standby Server, Primary DB and Standby DB status indicators in the NFM-P client GUI task bar. Each indicator must display Up.

2

Choose Administration→System Information. The System Information form opens.

3

View the general redundancy information:

- Domain Name—the NFM-P domain name specified at installation
- Redundancy Enabled—selected if redundancy is enabled
- Realignment Enabled—selected if automatic database realignment is enabled; displayed only if the NFM-P system is redundant
- Auto Standby Re-instantiation Enabled
- Realignment Status—Aligned or Not Aligned

4

View the following information in the Primary Server panel:

- Host Name—the host name of the primary or standalone main server
- Preferred DB—the preferred database of the main server
- Status—Unknown, Down, or Up

5

View the following information in the Primary Database Server panel:

- Instance Name—the name of the primary database instance, also called a SID
- IP Address—the IP address that each main or auxiliary server uses to reach the primary database
- Host Name—the host name of the primary or standalone main database

6

If the NFM-P system is redundant, view the following information in the Standby Server panel:

- Host Name—the host name of the standby main server
- Status—Unknown, Down, or Up

7

If the NFM-P system is redundant, view the following information in the Standby Database Server panel:

- Instance Name—the name of the standby database instance, also called a SID
- IP Address—the IP address that each main or auxiliary server uses to reach the standby database
- Host Name—the host name of the standby database

8

Click Properties to display additional information about the primary or standby main server. The Main Server (Edit) properties form opens.

9

View the following general main-server information:

-
- Host Name—the host name of the primary main server
 - Server Type—Main
 - Resource Managed—selected if the main server is included in NFM-P resource management

10

View the following information in the Client Communication panel:

- Private IP Address—the IP address that the main server uses as the source address for communication with the NFM-P GUI, browser, and XML API clients through a NAT router
- Public IP Address—the IP address that the NFM-P GUI, browser, and XML API clients use to reach the main server through a NAT router

 **Note:** The Private IP Address and Public IP Address display 0.0.0.0 when the NFM-P clients and the main server use host names, rather than IP addresses, for communication. The Private IP Address and Public IP Address display the same IP address when NAT is not used between the main server and clients.

11

View the following information in the Redundant Server Communication panel:

- Private IP Address—the IP address that the main server uses as the source address for communication with the standby main server through a NAT router
- Public IP Address—the IP address that the standby main server uses to reach the primary main server through a NAT router
- Peer Public IP Address—the IP address that the standby main server uses to reach the main server

 **Note:** The Private IP Address and Public IP Address display the same IP address when NAT is not used between the primary and standby main servers.

12

View the following information in the Redundancy Database State panel:

- Switchover State—whether switchover in progress, and operational state
- Last Attempted Switchover Time—time of previous switchover attempt
- Failover State—whether failover in progress, and operational state
- Last Attempted Failover Time—time of previous failover attempt
- Standby Re-instantiation State—whether re-instantiation is in progress, and operational state
- Last Attempted Standby Re-instantiation Time—time of previous standby re-instantiation attempt
- Number of Archive Logs To be Applied—number of archive logs that remain to be applied on standby database
- Estimated Time to Apply Archive Logs (seconds)—system time estimate for archive-log synchronization with standby database

13

View the following information in the Auxiliary Server Communication panel:

- Private IP Address—the IP address that the main server uses as the source address for communication with the auxiliary servers through a NAT router
- Public IP Address—the IP address that the auxiliary servers use to reach the primary main server

 **Note:** The Private IP Address and Public IP Address display the same IP address when NAT is not used between the main server and the auxiliary servers.

14

View the following information in the Main Server Communication panel:

- Server Public IP Address—the IP address that the auxiliary server uses to communicate with the main server

15

Close the Main Server properties form.

16

Click Database to view detailed database information, if required.

17

Click on the Faults tab to view alarm information, if required.

18

Close the form.

END OF STEPS

17.10 How do I view the NFM-P auxiliary server status?

17.10.1 Steps

1

Choose Administration→System Information. The System Information form opens.

2

Click on the Auxiliary Servers tab.

3

Review the list of auxiliary servers.

4

Select an auxiliary server in the list and click Properties. The properties form for the auxiliary server opens.

5

Review the auxiliary server information, which includes the following:

- Host Name—the host name of the auxiliary server
- Port Number—identifies the port that the auxiliary server uses to communicate with each main server and database
- Auxiliary Server Type—Reserved or Preferred
- Server Status—Unknown, Down, Up or Unused
- Resource Managed—selected if the auxiliary server is included in NFM-P resource management
- Public IP address—the IP address that the main servers use to reach the auxiliary server

6

Perform one of the following:

a. View the following main server information for a redundant system:

- Server 1 Public IP address—the IP address that the auxiliary server uses to communicate with the primary or standby main server
- Server 2 Public IP address—the IP address that the auxiliary server uses to communicate with the primary or standby main server

b. View the following main server information for a standalone system:

- Server Public IP address—the IP address that the auxiliary server uses to communicate with the main server

7

Click on the Auxiliary Services tab.

8

Review the list of auxiliary services.

9

Review the information for each auxiliary service, which includes the following:

- Service Name—the type of service, for example, statistics collection
- Selected—indicates whether this auxiliary server is currently used by a main server to process requests
- IP Address—the IPv4 address that the managed NEs use to reach the auxiliary server
- IPv6 Address—the IPv6 address that the managed Wavence NEs use to reach the auxiliary server
- Host Name—the host name of this auxiliary server

-
- Auxiliary Server Type—Reserved or Preferred

10

Close the Auxiliary Services form.

11

Click on the Faults tab to view alarm information, if required.

12

Close the form.

END OF STEPS

17.11 How do I perform a server activity switch?

17.11.1 Purpose

Perform this procedure to reverse the primary and standby roles of the main servers in a redundant system. Consider the following before you perform a server activity switch.

- A server activity switch stops and starts the primary main server. Server redundancy is unavailable until the main server is fully initialized as the new standby main server.
- During a server activity switch:
 - The NFM-P raises an alarm about the activity switch; the alarm is not self-clearing.
 - A main server does not process SNMP traps, attempt to synchronize NEs, or collect statistics.
 - All GUI, browser, and clients lose connectivity to the NFM-P.
 - Auxiliary servers process outstanding requests, but do not communicate with a main server.
- After a server activity switch:
 - The new primary main server deploys outstanding configuration changes to NEs, establishes communication with the auxiliary servers, and synchronizes information with the auxiliary servers.
 - The GUI clients automatically connect to the new primary main server.
 - XML API and browser clients must be redirected to the new primary main server.

17.11.2 Steps

1

Log in to the primary main server station as the nsp user.

2

Open a console window.

3

Enter the following:

```
bash$ /opt/nsp/nfmp/server/nms/bin/nmserver.bash force_restart ↵
```

The server activity switch begins. The primary main server restarts as the standby main server, and the standby main server restarts as the primary.

4

When the activity switch is complete, close the console window.

5

Reconnect each browser client to the NFM-P.

1. Close the browser window.
2. Open the browser window.



Note: After an activity switch, depending on the state of the former primary main server station, the NFM-P automatically redirects sign-in requests to the new primary main server. If the redirection fails to occur, you must open the sign-in page using the address of the new primary main server.

6

Redirect each XML API client to the new primary main server.

7

Manually clear the activity switch alarms, as required.

END OF STEPS

17.12 How do I configure main database switchover behavior?

17.12.1 Purpose

Perform this procedure on a redundant system to specify how database switchovers are executed. A database switchover occurs immediately upon request unless a database query is in progress, in which case the NFM-P does the following:

- if session interruption is enabled, waits a specified period before forcing the switchover
- if session interruption is disabled, the switchover does not occur and the Switchover State is Failed

17.12.2 Steps

1

Choose Administration→Database from the NFM-P main menu. The Database Manager (Edit) form opens.

2

Configure the required parameters:

-
- DB Session wait time (minutes)
 - Interrupt Read sessions after time out
 - Interrupt Write sessions after time out

3

Save your changes and close the form.

END OF STEPS

17.13 How do I perform a main database switchover using the NFM-P client GUI?

17.13.1 Purpose

Perform this procedure to use the NFM-P client GUI to switch the primary and standby database roles. Before you perform the procedure, ensure that you understand the following implications of a switchover.

- The primary and standby database roles are reversed.
- The primary main server connects to the new primary database.
- Archive logging begins on the new primary database.
- The primary main server directs each auxiliary server to connect to the new primary database.



CAUTION

Service Disruption

The execution of a database switchover depends on how the database switchover behavior is configured.

It is recommended that you review [17.12 “How do I configure main database switchover behavior?” \(p. 405\)](#) before you attempt to perform this procedure to verify the current database switchover configuration.

17.13.2 Steps

1

Log in to the client GUI as a user with the admin scope of command role.

2

Choose Administration→System Information from the NFM-P main menu. The System Information form opens.

3

Click Switchover and respond to the dialog box prompt.

 **Note:** The Switchover option is disabled when the correct switchover conditions are not in place, for example, when a switchover or failover is in progress.

4 _____
Click Yes. The NFM-P server performs the database switchover.

5 _____
Close the form.

END OF STEPS _____

17.14 How do I perform a main database switchover using a CLI script?

17.14.1 Purpose

Perform this procedure to use a CLI script to switch the primary and standby database roles. Before you perform the procedure, ensure that you understand the following implications of a switchover.

- The primary and standby database roles are reversed.
- The primary main server connects to the new primary database.
- Archive logging begins on the new primary database.
- The primary main server directs each auxiliary server to connect to the new primary database.



CAUTION

Service Disruption

The execution of a database switchover depends on how the database switchover behavior is configured.

It is recommended that you review [17.12 “How do I configure main database switchover behavior?” \(p. 405\)](#) before you attempt to perform this procedure to verify the current database switchover configuration.

17.14.2 Steps

1 _____
Log in to the primary main server station as the nsp user.

2 _____
Open a console window.

3 _____
Enter the following at the CLI prompt:

```
bash$ /opt/nsp/nfmp/server/nms/bin/switchoverdb.bash -u username -p  
password ↵
```

where *username* and *password* are the login credentials of an NFM-P user with the required privilege level and scope of command

The script displays the following confirmation message:

```
The standby database will become the new primary database, and the old
primary will become the new standby. Do you want to proceed? (YES/no)
:
```

4

Enter the following to initiate the switchover:

```
YES ↵
```

The NFM-P server initiates a database switchover. Progress is indicated by a rolling display of dots in the console window. The database switchover is complete when the CLI prompt reappears.

5

Close the console window when the database switchover is complete.

END OF STEPS

17.15 How do I enable or disable automatic database realignment?



CAUTION

Service Disruption

This procedure requires a primary main server restart, which is service-affecting.

Ensure that you perform this procedure only during a scheduled maintenance period.

i **Note:** This procedure applies only to redundant systems.

17.15.1 Steps

1

Perform [Step 4](#) to [Step 14](#) on the standby main server station.

2

Perform [Step 4](#) to [Step 14](#) on the primary main server station.



Note: When you stop the primary main server, a switchover to the standby main server occurs.

3

Go to [Step 15](#).

4

Log in to the main server as the nsp user.

5

Stop the main server.

1. Enter the following:

```
bash$ cd /opt/nsp/nfmp/server/nms/bin ↵
```

2. Enter the following:

```
bash$ ./nmserver.bash stop ↵
```

3. Enter the following:

```
bash$ ./nmserver.bash appserver_status ↵
```

The server status is displayed; the server is fully stopped if the status is the following:

```
Application Server is stopped
```

If the server is not fully stopped, wait five minutes and then repeat this step. Do not perform the next step until the server is fully stopped.

6

Enter the following to switch to the root user:

```
bash$ su - ↵
```

7

Enter the following:

```
# samconfig -m main ↵
```

The following is displayed:

```
Start processing command line inputs...
```

```
<main>
```

8

Perform one of the following:

a. Enable database alignment; perform the following steps.

1. Enter the following:

```
<main> configure redundancy database alignment ↵
```

```
Database alignment is enabled, and the prompt changes to <main configure  
redundancy database>.
```

2. Enter the following:

```
<main configure redundancy database> prefer-instance instance ↵
```

```
where instance is the database instance with which the main server is to align, typically  
the database instance on the same side of the management LAN
```

b. Disable database alignment; perform the following steps.

-
1. Enter the following:

```
<main> configure redundancy database no alignment ↵
```

Database alignment is disabled, and the prompt changes to <main configure redundancy database>.

9

- Enter the following:

```
<main configure redundancy database> exit ↵
```

The prompt changes to <main>.

10

- Enter the following:

```
<main> apply ↵
```

The configuration change is applied.

11

- Enter the following:

```
<main> exit ↵
```

The samconfig utility closes.

12

- Enter the following to switch back to the nsp user:

```
# exit ↵
```

13

Start the main server.

1. Enter the following:

```
bash$ cd /opt/nsp/nfmp/server/nms/bin ↵
```

2. Enter the following:

```
bash$ ./nmserver.bash start ↵
```

3. Enter the following:

```
bash$ ./nmserver.bash appserver_status ↵
```

The server status is displayed; the server is fully initialized if the status is the following:

```
Application Server process is running. See nms_status for more detail.
```

If the server is not fully initialized, wait five minutes and then repeat this step. Do not perform the next step until the server is fully initialized.

14

Log out of the main server station.

15

If required, perform [17.11 “How do I perform a server activity switch?” \(p. 404\)](#) to perform a server activity switch to revert the primary and standby main servers to their initial roles.

END OF STEPS

17.16 How do I configure the IPDR file-transfer policy?

17.16.1 Purpose

Perform this procedure to specify the target servers to which the NFM-P main or auxiliary servers forward IPDR-formatted AA accounting statistics.

 **Note:** An main or auxiliary server does not retain any IPDR files that are successfully transferred to a target server; each successfully transferred file is deleted after the transfer.

17.16.2 Steps

1

Choose Tools→Statistics→IPDR File Transfer Policies from the NFM-P main menu. The IPDR File Transfer Policies form opens.

2

Select the default policy and click Properties. The IPDR File Transfer Policy form (Edit) opens.

3

Select the Enabled parameter.

4

Configure the File Transfer Protocol parameter.

5

Configure the parameters in the Transfer Target panel to specify the target IP address or hostname, port, file-transfer user credentials, and the directory on the target server in which to store the transferred statistics files.

 **Note:** The directory that you specify must be the absolute path of an existing directory on the target server.

 **Note:** The specified user requires read and write access to the specified directory.

6

Configure the parameters in the Alternate Transfer Target panel to specify a redundant transfer target, if required.

 **Note:** The directory that you specify must be the absolute path of an existing directory on the target server.

 **Note:** The specified user requires read and write access to the specified directory.

7

Click OK to save your changes and close the form.

END OF STEPS

Part V: NSP component administration

Overview

Purpose

This part of the *NSP System Administrator Guide* provides dummy text.

Contents

Chapter 18, MDM administration	415
Chapter 19, NSP Flow Collector / Controller administration	435
Chapter 20, NSP auxiliary database administration	451
Chapter 21, Classic management administration	511
Chapter 22, Classic management database administration	633

18 MDM administration

18.1 What is MDM administration?

18.1.1 Description

In general, MDM administration consists of:

- adaptor artifact management: MDM adaptors are a type of NSP artifact that cannot currently be managed from the Artifacts views in the NSP GUI.
 - For more information about artifacts, see “Inventory management” in the *NSP Network Automation Guide*.
 - For information about the adaptors required for a specific NE, see the artifact guide for the NE.
- TLS configuration
- management of YANG model definitions and NE model definitions
- device mapping files for telemetry and resync

The procedures in this chapter describe operations performed on NSP host servers to support model-driven mediation.

 **Note:** The procedures in this chapter include the following RHEL CLI prompts in command lines to denote the active user. They are not to be included in typed commands:

- # —root user
- bash\$ —nsp user

18.2 How do I install adaptor artifacts that are not supported in the Artifacts view?

18.2.1 Purpose



CAUTION

Deployment Failure

You may need to uninstall one or more existing adaptors before you install a new adaptor, or the adaptor installation fails.

Before you install an adaptor, ensure that you read the adaptor artifact documentation to determine whether any existing adaptors conflict with the new adaptor and must be removed before the new adaptor installation.

Perform this procedure to install or upgrade adaptor artifacts to enable MDM NE discovery and management. While many NSP artifacts can be installed using the Artifacts view in the NSP GUI, some must be installed by script using this procedure. See the artifact documentation provided with the adaptor artifacts for information about which installation method is required.

18.2.2 Before you begin

If you require custom or reference adaptors for your network, contact Nokia.

The following must be true before you attempt to perform the procedure:

- The NSP system includes MDM and is operational.
- The NSP clusters, MDM servers, mdm-tomcat service, and file service are initialized and operational.

i **Note:** In this procedure, *release-ID* in a file path has the following format:

R.r.p-rel.version

where

R.r.p is the NSP release, in the form *MAJOR.minor.patch*

version is a numeric value

18.2.3 Steps

1

Obtain the adaptor suite and associated artifact documentation from the [Nokia NSP software delivery site](#), in the NSP/<release>/Adaptors folder.

2

Check the artifact documentation to see if any adaptors need to be removed before proceeding with the installation.

See [18.7 “How do I uninstall MDM adaptors?” \(p. 426\)](#) to uninstall an adaptor if needed, then proceed to the next step.

3

Log in as the root user on the NSP deployer host in the standalone or primary NSP cluster.

i **Note:** In a DR deployment, you perform the installation or upgrade only on the primary NSP cluster, which then replicates the adaptor configuration to the standby cluster.

4

Transfer the adaptor suite zip file to an empty temporary directory.

5

Open a console window.

6

Enter the following:

```
# cd /opt/nsp/NSP-CN-DEP-release-ID/NSP-CN-release-ID/tools/mdm/bin ↵
```

7

Enter the following to verify that the RESTCONF token for the NSP cluster is valid:

```
# ./adaptor-suite.bash --list ↵
```

Enter the NSP admin user credentials when prompted.

Messages like the following are displayed if the token is valid.

```
Using log file: log_file
```

```
INFO: timestamp -> Listing MDM adaptors suites ...
```

```
INFO: timestamp -> Token requested...
```

```
INFO: timestamp -> Token acquired
```

```
INFO: timestamp -> Listing adaptor suites...
```

```
Installed adaptor suites:
```

```
list_of_adaptors
```

```
INFO: timestamp -> Done.
```

8

Enter the following:

i **Note:** Multiple files and wildcards are supported. For example, `sros*` specifies all adaptor suites whose filenames begin with `sros`.

```
# ./adaptor-suite.bash --install filespec_1 filespec_2 . . .  
filespec_n ↵
```

where

`filespec_1` to `filespec_n` are one or more adaptor zip file specifications; each must include the absolute file path

Enter the NSP admin user credentials when prompted.

9

Enter the credentials.

The adaptors are transferred to each MDM instance.

i **Note:** It may take 30 minutes or more for all adaptors to load.

After the adaptors load, you can use Device Discovery to discover compatible devices.

10

If the NSP system is a DR deployment, verify that the primary and standby file-service-app pods are communicating.

1. Log in as the root user on the NSP cluster host in the standby NSP cluster.
2. Enter the following:

```
# kubectl exec -n $(kubectl get pods -A | awk  
'/nsp-file-service-app/ {print $1;exit}') -it  
nsp-file-service-app-0 -- ls
```

```
/opt/nsp/containers/nspvolume/fileservice/nokia/nsp/mdm/features/suite/
↵
```

Messages like the following are displayed, and the MDM adaptor zip files are listed.

```
Defaulting container name to nsp-file-service-app
```

```
Use 'kubectl describe pod/nsp-file-service-app-0 -n default' to see
all of the containers in this pod.
```

If the adaptor zip files are listed, the primary and standby pods are communicating; the adaptors are installed on the standby cluster upon DR activation of the standby cluster.

11

Close the open console windows.

END OF STEPS

18.3 How do I enable mTLS on the NSP mediation interface?

18.3.1 Purpose

Perform this procedure to enable two-way TLS authentication using mTLS on the network mediation interface of an NSP cluster.

 **Note:** You must perform the procedure in each NSP cluster.

18.3.2 Steps

1

Log in as the root user on the NSP deployer host.

2

Open a console window.

3

Open the following file using a plain-text editor such as vi:

```
/opt/nsp/NSP-CN-DEP-release-ID/NSP-CN-release-ID/config/nsp-config.yml
```

4

Configure the following parameters in the **nsp—modules—mdm** section of the file:

```
mtls:
  enabled: true
  mtlsCACert: "CA_cert"
  mtlsClientCert: "client_cert"
  mtlsKey: "client_key"
```

```
mtlsKeyAlgorithm: "RSA"
```

where

CA_cert is the absolute path of the CA certificate file

client_cert is the absolute path of the client certificate file

client_key is the absolute path of the client key file

5

Save and close the file.

6

Enter the following to put the configuration change into effect:



Note: The command causes a restart of each MDM pod in the cluster, but is not service-affecting.



Note: If the NSP cluster VMs do not have the required SSH key, you must include the `--ask-pass` argument in the command, as shown in the following example, and are subsequently prompted for the root password of each cluster member:

```
nspdeployerctl --ask-pass install --config --deploy
```

```
# /opt/nsp/NSP-CN-DEP-release-ID/bin/nspdeployerctl install --config  
--deploy ↵
```

mTLS is enabled on the cluster mediation interface.

7

Close the console window.

END OF STEPS

18.4 How do I enable TLS for telemetry and gNMI on_change support?

18.4.1 Purpose

To enable TLS communication between MDM and managed NEs after an NSP system deployment, you must deploy a signed TLS server certificate to each MDM-managed device that supports gRPC TLS, and import the corresponding CA certificate to each MDM truststore. While it is possible to have more than one CA certificate added to each MDM truststore, it is generally preferable to limit the number of CA certificates to the minimum required to adequately secure the network.

The following steps describe how to secure the following NSP communication with NEs by importing a TLS certificate:

- telemetry
- gNMI on_change notifications



Note: TLS certificates for gRPC mediation are separate from the certificates that secure communication between the NSP components and NBI-related certificates.

i **Note:** *release-ID* in a file path has the following format:

R.r.p-rel.version

where

R.r.p is the NSP release, in the form *MAJOR.minor.patch*

version is a numeric value

18.4.2 Steps

1

Log in as the root user on the NSP deployer host.

2

Transfer the CA certificate to the following directory:

/opt/nsp/NSP-CN-DEP-release-ID/NSP-CN-release-ID/tls/telemetry

i

Note: You must not modify or delete any existing file in the directory.

3

Log in as the root user on the NSP cluster host.

4

Open a console window.

5

Enter the following command for each namespace to delete the `nsp-tls` Kubernetes secret:

```
# kubectl delete secret nsp-tls -n $(kubectl get secrets -A | awk  
'/namespace/ {print $1;exit}')
```

where *namespace* is the Kubernetes namespace

6

On the NSP deployer host, enter the following:

i

Note: If the NSP cluster VMs do not have the required SSH key, you must include the `--ask-pass` argument in the command, as shown in the following example, and are subsequently prompted for the root password of each cluster member:

```
nspdeployerctl --ask-pass install --config --deploy
```

```
# /opt/nsp/NSP-CN-DEP-release-ID/bin/nspdeployerctl install --config  
--deploy
```

The certificate file is made available to each MDM instance, but not yet imported.

Import certificate to MDM servers

7

Perform one of the following to import the TLS certificate to the TLS truststore on each MDM server.

- a. Manually import the certificate; perform the following steps for each MDM server to activate the gRPC certificate file.

i **Note:** A manual import is not service-affecting, and is the recommended option.

1. Transfer the certificate file in the `/opt/nsp/NSP-CN-DEP-release-ID/NSP-CN-release-ID/tls/telemetry` directory on the NSP deployer host to an empty temporary directory on the NSP cluster host.
2. On the NSP cluster host, navigate to the temporary directory that holds the transferred file.
3. Enter the following to copy the certificate file to the MDM server:

```
# kubectl cp -n namespace certificate_file mdm-server-n:  
/opt/nsp/os/ssl/certs/telemetry ↵
```

where

namespace is the Kubernetes namespace

n is the mdm-server pod number

certificate_file is the name of the certificate file

4. Enter the following:

```
# kubectl exec -n $(kubectl get pods -A | awk '/mdm-server/ {print $1;exit}') -it mdm-server-n -- keytool -alias alias -file  
/opt/nsp/os/ssl/certs/telemetry/certificate_file -import -keystore  
/opt/nsp/os/ssl/nsp.truststore -storepass password ↵
```

where

n is the mdm-server pod number

alias is the TLS keystore alias of the certificate

certificate_file is the gRPC certificate file

password is the TLS keystore password

You are prompted to import the certificate.

5. Enter yes ↵.

The MDM server imports the certificate to the local TLS truststore.

- b. Restart the MDM server pod; perform [18.9 “How do I restart an MDM server?”](#) (p. 432) for each MDM server pod.

i **Note:** Restarting an MDM server pod is service-affecting, and must be performed only during a scheduled maintenance period.

8 _____
Close the open console windows.

END OF STEPS _____

18.5 How do I manage MDM model definitions?

18.5.1 Purpose

The following steps describe how to manage the YANG model definitions and NE model definitions in an NSP cluster.

i **Note:** The `yang-files.bash` script prompts for NSP administrative user credentials. To suppress the prompt, you can include the credentials in the script command line; for example:

```
# ./yang-files.bash --list --user user --pass password ↵
```

where `user` and `password` are the NSP administrative user credentials

For simplicity, the credentials and prompt are not shown in the procedure steps.

i **Note:** The NSP system must be fully operational when you perform the procedure.

i **Note:** If you are adding model definitions:

- The new model-definition files must be in a directory accessible to the NSP deployer host.
- If a zipped collection of files is being installed, all files in the collection must be of the same type.

i **Note:** If you are adding an NE model, the required files are in a compressed archive file; contact Nokia for access to the file.

i **Note:** `release-ID` in a file path has the following format:

R.r.p-rel.version

where

R.r.p is the NSP release, in the form *MAJOR.minor.patch*

version is a numeric value

18.5.2 Steps

1 _____
Log in as the root user on the NSP deployer host in the standalone or primary NSP cluster.

2 _____
Open a console window.

3 _____
Enter the following:

```
# cd /opt/nsp/NSP-CN-DEP-release-ID/NSP-CN-release-ID/tools/mdm/bin ↵
```

Manage YANG models

4

To list the names of all installed module sets, enter the following:

```
# ./yang-files.bash --list ↵
```

The module sets are listed.

5

To list the names of the YANG models in a module set, enter the following:

```
# ./yang-files.bash --modulesetname module_set --list ↵
```

where *module_set* is the module set name

The YANG model names are listed in the following format:

```
model_name -> (namespace, revision)
```

6

To save all YANG models in a module set as files, enter the following:

```
# ./yang-files.bash --modulesetname module_set --save path ↵
```

where

module_set is the module set name

path is an existing directory on the local file system

The model files are created in the specified directory.

7

To save specific YANG models in a module set as files, enter the following:

```
# ./yang-files.bash --modulesetname module_set --model model_1 model_2  
. . . model_n --save path ↵
```

where

module_set is the module set name

model_1 model_2 . . . model_n is a list of the YANG models to save

path is an existing directory on the local file system

The model files are created in the specified directory.

8

To add one or more YANG model definitions, enter the following:

i **Note:** Because of the heavy processing load associated with importing model definitions, it is strongly recommended that you do not attempt to install all YANG files in a bundle at once.

If you need to install a large number of YANG files, the recommended method is to install only the immediately required files, in small batches, and install any additional YANG files later, as required.

If the following message is displayed after you try to install YANG files, you may need to install fewer files at a time; you can use the command option in the message to verify that the current operation installed all specified files:

```
WARN: Timeout uploading yang files. Please verify with --list
--modulesetname module_set
```

```
# ./yang-files.bash --modulesetname module_set --add path ↵
```

where

module_set is the module set name

path is the path to a YANG definition file, or to a directory that contains definition files

9

To remove one or more YANG model definitions, enter the following:

```
# ./yang-files.bash --modulesetname module_set --remove definition_1
definition_2 . . . definition_n ↵
```

where

module_set is the module set name

definition_1 definition_2 . . . definition_n is a list of model definitions in the following format:

modelname, namespace, revision

Add NE model definitions

10

To add one or more NE model definitions, enter the following:

```
# ./ne-model.bash --install definition_file ↵
```

where *definition_file* is the path and name of an NE model zip file

11

Close the open console windows.

END OF STEPS

18.6 How do I manage MDM device mappings?

18.6.1 Purpose

The following steps describe how to manage the device mappings for MDM in an NSP cluster.

i **Note:** The NSP system must be fully operational when you perform the procedure.

i **Note:** In order to add device mappings:

- The new device-mapping files must be in a directory accessible to the NSP deployer host.
- If a zipped collection of files is being installed, all files in the collection must be of the same type, for example, telemetry device mappings.

i **Note:** *release-ID* in a file path has the following format:

R.r.p-rel.version

where

R.r.p is the NSP release, in the form *MAJOR.minor.patch*

version is a numeric value

18.6.2 Steps

1 _____
Log in as the root user on the NSP deployer host in the standalone or primary NSP cluster.

2 _____
Open a console window.

3 _____
Enter the following:

```
# cd /opt/nsp/NSP-CN-DEP-release-ID/NSP-CN-release-ID/tools/mdm/bin ↵
```

4 _____
To list the current device mappings, which are in JSON format, enter the following:

i **Note:** The `--ne` option applies only to resync mappings, and is optional.

i **Note:** The `--class` option applies only to nfmp-resync mappings, and is optional.

i **Note:** If the `--ne` and `--class` options are omitted, all mappings of the specified type are listed.

i **Note:** The `--save` option saves the list to a file, and is valid only for telemetry mappings.

```
# ./json-files.bash --list --mapping mapping_type --ne device_def  
--class class_path --save path --user user --pass password ↵
```

where

mapping_type is one of the following mapping types: telemetry, resync, or nfmp-resync

device_def is a device type definition, for example, SR-7750,21.10.R1

class_path is the NFM-P class path of the device type, in XPath format

path is an existing local directory in which to save the mapping list

user and *password* are the credentials of an NSP administrative user

5 _____
To add one or more JSON mapping files, enter the following:

```
# ./json-files.bash --add path --user user --pass password ↵
```

where

path is the path to a JSON mapping file, or to a directory that contains mapping files
user and *password* are the credentials of an NSP administrative user

6

Enter the following to remove one or more device mappings:



Note: The `--filename` option is required only for telemetry mappings.



Note: The `--ne` option applies only to resync mappings, and is optional.



Note: The `--class` option applies only to nfmp-resync mappings, and is optional.



Note: If the `--ne` and `--class` options are omitted, all mappings of the specified type are removed.

```
# ./json-files.bash --remove --mapping mapping_type --filename  
mapping_1 mapping_2 ...mapping_n --ne device_type --class class_path  
--user user --pass password ↵
```

where

mapping_type is one of the following mapping types: telemetry, resync, or nfmp-resync

mapping_1 mapping_2 ...mapping_n is a list of telemetry mapping files to remove

device_type is a device type definition, for example, SR-7750,21.10.R1; a value has the following format: neType,neVersion—for example, SR-7750,21.10.R1

class_path is the NFM-P class path of the device type, in XPath format

user and *password* are the credentials of an NSP administrative user

7

Close the console window.

END OF STEPS

18.7 How do I uninstall MDM adaptors?

18.7.1 Purpose



WARNING

Network Management Degradation

After you remove an MDM adaptor, you cannot re-install or reinstantiate the adaptor using a restart of any pod in the local NSP cluster, or a DR switchover. Consequently, NSP network management may be severely compromised.

Before you attempt to remove an adaptor, you must ensure that no dependencies on the adaptor exist.

An NSP MDM adaptor suite may include many adaptors; for example, a large number of adaptors that are common to all software versions and chassis types of a device. However, only some of the adaptors may be relevant to your network management needs, while the others unnecessarily consume system resources.

Perform this procedure to permanently remove one or more individual MDM adaptors from the NSP for the purpose of resource optimization.

i **Note:** To remove one or more MDM adaptor suites, see [18.8 “How do I uninstall MDM adaptor suites?”](#) (p. 429).

i **Note:** In a DR deployment, you perform the uninstallation only on the primary NSP cluster, which then replicates the adaptor configuration on the standby cluster.

i **Note:** *release-ID* in a file path has the following format:
R.r.p-rel.version
where
R.r.p is the NSP release, in the form *MAJOR.minor.patch*
version is a numeric value

18.7.2 Steps

1 _____
Log in as the root user on the NSP deployer host in the standalone or primary data center.

2 _____
Open a console window.

3 _____
Enter the following:

```
# cd /opt/nsp/NSP-CN-DEP-release-ID/NSP-CN-release-ID/tools/mdm/bin ↵
```

4 _____
Enter the following to verify that the RESTCONF token for the NSP cluster is valid:

```
# ./adaptor-suite.bash --list ↵
```

Enter the NSP admin user credentials when prompted.
Messages like the following are displayed if the token is valid.

```
Using log file: log_file  
INFO: timestamp -> Listing MDM adaptors suites ...  
INFO: timestamp -> Token requested...  
INFO: timestamp -> Token acquired  
INFO: timestamp -> Listing adaptor suites...  
Installed adaptor suites:
```

```
list_of_adaptor_suites  
INFO: timestamp -> Done.
```

5

It is strongly recommended that you list the adaptors and check the artifact guide for network management dependencies before any adaptor is removed.

To list the adaptors on the file system, enter the following:

i **Note:** The `--list-adaptors` option queries the installed adaptors on the MDM server; by contrast, the `--list` option displays the adaptor suites in the PostgreSQL database. Consequently, until the next periodic NSP cluster data synchronization, an adaptor that you remove may be temporarily shown in the `--list` option output.

i **Note:** To filter the command output for a specific vendor, pipe the output to `grep`; for example, the following lists only adaptors whose name includes 'sros':

```
adaptor-suite.bash --list-adaptors | grep sros ↵
```

```
# ./adaptor-suite.bash --list-adaptors ↵
```

Enter the NSP admin user credentials when prompted.

6

Enter the following to remove one or more individual adaptors:

```
# ./adaptor-suite.bash --remove-adaptor file_1 file_2 . . . file_n ↵
```

where `file_1` to `file_n` are adaptor file names; each must include the absolute path

Enter the NSP admin user credentials when prompted.

7

Enter the NSP admin user credentials.

The adaptors are removed from each running MDM instance.

i **Note:** It may take 30 minutes or more for adaptors to be removed.

8

Close the console window.

END OF STEPS

18.8 How do I uninstall MDM adaptor suites?

18.8.1 Purpose



WARNING

Network Management Degradation

After you remove an MDM adaptor suite, you cannot re-install or reinstantiate the adaptor suite using a restart of any pod in the local NSP cluster, or a DR switchover. Consequently, network management may be severely compromised.

Before you attempt to remove an MDM adaptor suite, you must ensure that there are no dependencies on any adaptor in the adaptor suite.

Perform this procedure to permanently remove one or more MDM adaptor suites from the NSP.

i **Note:** If you are currently upgrading a Release 22.3 or earlier NSP system, you may need to uninstall an adaptor suite from the older system as an upgrade requirement. The procedure steps include release-specific references to support such upgrade-related activity.

i **Note:** In a DR deployment, you perform the adaptor-suite uninstallation in the primary data center; the NSP file-service-app subsequently synchronizes the primary and standby adaptor configurations.

i **Note:** *release-ID* in a file path has the following format:
R.r.p-rel.version
where
R.r.p is the NSP release, in the form *MAJOR.minor.patch*
version is a numeric value

18.8.2 Steps

- 1 _____
Perform one of the following.
 - a. If the NSP system is at Release 21.11 or earlier, log in as the root user on the NSP configurator VM in the standalone or primary data center.
 - b. Log in as the root user on the NSP deployer host in the standalone or primary data center.
- 2 _____
Open a console window.
- 3 _____
Perform one of the following.
 - a. If the NSP system is at Release 21.11 or earlier, enter the following:

```
# cd /opt/nsp/NSP-CN-DEP-release-ID/tools/mdm/bin ↵
```

b. Enter the following:

```
# cd /opt/nsp/NSP-CN-DEP-release-ID/NSP-CN-release-ID/tools/mdm/bin  
↵
```

4

Enter the following to verify that the RESTCONF token for the NSP cluster is valid:

```
# ./adaptor-suite.bash --list ↵
```

Enter the NSP admin user credentials when prompted.

Messages like the following are displayed if the token is valid.

```
Using log file: log_file  
INFO: timestamp -> Listing MDM adaptors suites ...  
INFO: timestamp -> Token requested...  
INFO: timestamp -> Token acquired  
INFO: timestamp -> Listing adaptor suites...  
Installed adaptor suites:  
list_of_adaptor_suites  
INFO: timestamp -> Done.
```

5

It is strongly recommended to list the adaptor suites and check for network management dependencies before any adaptor suite is removed.

To list the adaptor suites on the file system, enter the following:

i **Note:** The `--list-adaptors` option queries the installed adaptors on the MDM server; by contrast, the `--list` option displays the adaptor suites in the PostgreSQL database. Consequently, until the next periodic NSP cluster data synchronization, an adaptor that you remove may be temporarily shown in the `--list` option output.

i **Note:** To filter the command output for a specific vendor, pipe the output to `grep`; for example, the following lists only adaptor suites whose name includes 'sros':

```
adaptor-suite.bash --list | grep sros ↵
```

```
# ./adaptor-suite.bash --list ↵
```

Enter the NSP admin user credentials when prompted.

6

Enter the following to remove one or more adaptor suites:

```
# ./adaptor-suite.bash --remove zipfile_1 zipfile_2 . . . zipfile_n ↵
```

where `zipfile_1` to `zipfile_n` are adaptor-suite zip-file specifications; each must include the absolute path

Enter the NSP admin user credentials when prompted.

7

Enter the NSP admin user credentials.

The adaptors are removed from each running MDM instance.

i **Note:** It may take 30 minutes or more for adaptors to be removed.

8

If the NSP system is at Release 22.3 or later, enter the following to display the adaptor suites that the --cleanup option in [Step 10](#) removes:

i **Note:** The --list-cleanup option displays the adaptor suites that are uninstalled from the MDM servers but still available in the PostgreSQL database and file-service-app pod.

```
# ./adaptor-suite.bash --list-cleanup ↵
```

Enter the NSP admin user credentials when prompted.

9

If the NSP system is a DR deployment, verify that the primary and standby file-service-app pods are communicating.

1. Log in as the root user on the NSP cluster host in the primary NSP cluster.
2. Enter the following:

```
# kubectl exec -n $(kubectl get pods -A | awk  
'/nsp-file-service-app/ {print $1;exit}') -it  
nsp-file-service-app-0 -- ls  
/opt/nsp/containers/nspvolume/fileservice/nokia/nsp/mdm/features/suite/ ↵
```

Messages like the following are displayed, and the MDM adaptor zip files are listed.

```
Defaulting container name to nsp-file-service-app
```

```
Use 'kubectl describe pod/nsp-file-service-app-0 -n default' to see  
all of the containers in this pod.
```

3. Log in as the root user on the NSP cluster host in the standby NSP cluster.
4. Open a console window.
5. Enter the following:

```
# kubectl exec -n $(kubectl get pods -A | awk  
'/nsp-file-service-app/ {print $1;exit}') -it  
nsp-file-service-app-0 -- ls  
/opt/nsp/containers/nspvolume/fileservice/nokia/nsp/mdm/features/suite/ ↵
```

Messages like the following are displayed, and the MDM adaptor zip files are listed.

```
Defaulting container name to nsp-file-service-app
```

```
Use 'kubectl describe pod/nsp-file-service-app-0 -n default' to see  
all of the containers in this pod.
```

6. Compare the lists of adaptor zip files on the primary and standby file-service-app pods.
If the lists match, the file-service-app pods are communicating correctly.

10



WARNING

Network Management Degradation

In a DR NSP deployment, performing this step when the adaptors on the primary and standby clusters do not match may severely degrade network management and require a cluster redeployment.

Before you perform the step in a DR deployment, you must be certain that the list of installed adaptors on the standby MDM servers matches the list of installed adaptors on the primary MDM servers.

Enter the following to delete all references to all uninstalled adaptor suites from the PostgreSQL database and file-service-app:

```
# ./adaptor-suite.bash --cleanup ↵
```

Enter the NSP admin user credentials when prompted.

All references to the uninstalled adaptor suites are removed.

11

Close the console window.

END OF STEPS

18.9 How do I restart an MDM server?

18.9.1 Purpose

Perform the following steps to restart an MDM server in an NSP cluster.

18.9.2 Steps

1

Log in as the root user on the NSP cluster host.

2

Open a console window.

3

Enter the following to display the MDM server instances:

```
# kubectl get pods -A | grep mdm-server ↵
```

The MDM server instances and pod numbers are listed.

4

Enter the following:

```
# kubectl delete pod mdm-server-n -n $(kubectl get pods -A | awk  
'/mdm-server/ {print $1;exit}')
```

where n is the MDM server pod number

The MDM server restarts.

5

Repeat [Step 4](#) to restart an additional MDM server, as required.

6

Close the console window.

END OF STEPS

19 NSP Flow Collector / Controller administration

19.1 Overview

19.1.1 Purpose

Dummy text

19.1.2 Contents

19.1 Overview	435
NSP Flow Collector Controller configuration and management	436
19.2 What does NSP Flow Collector Controller administration involve?	436
19.3 How do I start or stop an NSP Flow Collector Controller?	436
19.4 How do I display the NSP Flow Collector Controller status or release level?	437
19.5 How do I open the NSP Flow Collector Controller web UI?	438
19.6 How do I force an NSP Flow Collector Controller to extract a network data snapshot?	439
NSP Flow Collector configuration and management	440
19.7 What does NSP Flow Collector administration involve?	440
19.8 How do I start or stop an NSP Flow Collector?	440
19.9 How do I display the NSP Flow Collector status or release level?	441
19.10 Workflow: configure flow statistics collection	443
19.11 How do I open the NSP Flow Collector web UI?	443
19.12 How do I specify the NEs and MDAs for flow statistics collection	444
19.13 How do I configure the AA flow data persistence?	445
19.14 How do I configure flow statistics aggregation?	445
19.15 How do I configure the transfer of result files?	446
19.16 How do I configure CSV file compression and renaming?	447
19.17 How do I configure an AA Cflowd special-study policy?	448
19.18 How do I configure an AA application or protocol filter?	449

NSP Flow Collector Controller configuration and management

19.2 What does NSP Flow Collector Controller administration involve?

19.2.1 Description

You may occasionally need to perform one or more of the following on an NSP Flow Collector Controller, which is an ancillary NSP component deployed outside the NSP cluster:

- Start or stop the component.
- Display the component status or release level.
- Open the component web UI for configuration purposes.
- Force an NFM-P network data extraction.

The following procedures describe how to perform such actions.

i **Note:** The following RHEL CLI prompts in command lines denote the active user, and are not to be included in typed commands:

- # —root user
- bash\$ —nsp user

19.3 How do I start or stop an NSP Flow Collector Controller?

19.3.1 Purpose

The following steps describe how to start or stop an NSP Flow Collector Controller that is on a dedicated station, or collocated with an NSP Flow Collector.



CAUTION

Data loss

Stopping an NSP Flow Collector Controller may affect the statistics collection of the associated NSP Flow Collectors.

Perform the procedure only under the guidance of technical support during a scheduled maintenance period.

19.3.2 Steps

- 1 _____
Log in as the nsp user on the NSP Flow Collector Controller station.
- 2 _____
Open a console window.

3

Enter the following:

```
bash$ cd /opt/nsp/flow/fcc/bin ↵
```

4

To stop the NSP Flow Collector Controller, enter the following:

i **Note:** If the NSP Flow Collector Controller is collocated with an NSP Flow Collector, stopping the NSP Flow Collector Controller also stops the Flow Collector.

```
bash$ ./flowCollectorController.bash stop ↵
```

The NSP Flow Collector Controller stops.

5

To start the NSP Flow Collector Controller, enter the following:

i **Note:** If the NSP Flow Collector Controller is collocated with an NSP Flow Collector, starting the NSP Flow Collector Controller also starts the Flow Collector.

```
bash$ ./flowCollectorController.bash start ↵
```

The NSP Flow Collector Controller starts.

6

Close the console window.

END OF STEPS

19.4 How do I display the NSP Flow Collector Controller status or release level?

19.4.1 Purpose

The following steps describe how to view the operational status or software release of an NSP Flow Collector Controller that is on a dedicated station, or collocated with an NSP Flow Collector.

19.4.2 Steps

1

Log in as the nsp user on the NSP Flow Collector Controller station.

2

Open a console window.

3

Enter the following:

```
bash$ cd /opt/nsp/flow/fcc/bin ↵
```

4

To view the NSP Flow Collector Controller status, enter the following:

```
bash$ ./flowCollectorController.bash status ↵
```

The NSP Flow Collector Controller status is displayed.

If the NSP Flow Collector Controller is running, the line that begins with flow-collector-controller includes Started.

If the NSP Flow Collector Controller is not running, the following is displayed:

```
nspos-karaf.service is not running
```

5

To view the NSP Flow Collector Controller release level, enter the following:

```
bash$ ./flowCollectorController.bash version ↵
```

The NSP Flow Collector Controller release level is displayed

6

Close the console window.

END OF STEPS

19.5 How do I open the NSP Flow Collector Controller web UI?

19.5.1 Purpose

The following steps describe how to open the NSP Flow Collector Controller web UI for Flow Collector Controller configuration.

19.5.2 Steps

1

Use a browser to open the following URL:

```
https://server.8443/fcc/admin
```

where *server* is the NSP Flow Collector Controller IP address or hostname

2

Enter the required user credentials and click OK. The NSP Flow Collector Controller web UI opens.

END OF STEPS

19.6 How do I force an NSP Flow Collector Controller to extract a network data snapshot?

19.6.1 Purpose

An NSP Flow Collector Controller requires an image, called a snapshot, of current NFM-P data that is subsequently distributed to each NSP Flow Collector that it controls.

The following steps describe how to force an NSP Flow Collector Controller to extract the system Cflowd or AA Cflowd provisioned-object snapshot from the NFM-P.



CAUTION

Service Disruption

Performing the procedure consumes NFM-P main server resources, and is typically required only when recommended by technical support.

Perform the procedure only if required, and only under the guidance of technical support during a period of low NFM-P system activity.

19.6.2 Steps

- 1 _____
Open the NSP Flow Collector Controller web UI, as described in [19.5 “How do I open the NSP Flow Collector Controller web UI?” \(p. 438\)](#).
The NFM-P Configuration tab is displayed.
- 2 _____
Click on the Operations tab.
- 3 _____
To force the snapshot extraction for AA Cflowd statistics collection, click Force AA Snapshot Extraction.
The extraction begins.
- 4 _____
To force the snapshot extraction for system Cflowd statistics collection, click Force SYS Snapshot Extraction.
The extraction begins.
- 5 _____
Close the NSP Flow Collector Controller web UI.

END OF STEPS _____

NSP Flow Collector configuration and management

19.7 What does NSP Flow Collector administration involve?

19.7.1 Description

You may occasionally need to perform one or more of the following on an NSP Flow Collector, which is an ancillary NSP component deployed outside the NSP cluster:

- Start or stop the component.
- Display the component status or release level.
- Configure flow collection using the component web UI; see [19.10 “Workflow: configure flow statistics collection” \(p. 443\)](#) for information.

The following procedures describe how to perform such actions.

 **Note:** The configuration operations require a familiarity with flow statistics and the associated NSP collection, transfer, and storage mechanisms. See the “Flow statistics collection” chapter in the *NSP NFM-P Statistics Management Guide* for information about the flow statistics collection and processing options.

 **Note:** The following RHEL CLI prompts in command lines denote the active user, and are not to be included in typed commands:

- # —root user
- bash\$ —nsp user

19.8 How do I start or stop an NSP Flow Collector?

19.8.1 Purpose

The following steps describe how to start or stop an NSP Flow Collector that is on a dedicated station, or collocated with an NSP Flow Collector Controller.



CAUTION

System degradation

On a station that hosts a collocated NSP Flow Collector and NSP Flow Collector Controller, starting or stopping the Flow Collector also starts or stops the Flow Collector Controller, and affects all Flow Collectors associated with the Controller.

Before you stop an NSP Flow Collector that is collocated with a Flow Collector Controller, ensure that you understand the implications of the action.

19.8.2 Steps

1

Log in as the nsp user on the NSP Flow Collector station.

-
- 2** _____
Open a console window.
- 3** _____
Enter the following:
`bash$ cd /opt/nsp/flow ↵`
- 4** _____
To stop the NSP Flow Collector, perform one of the following:
- a. If the NSP Flow Collector is collocated with an NSP Flow Collector Controller, enter the following:
`bash$./fcc/bin/flowCollectorController.bash stop ↵`
The NSP Flow Collector and NSP Flow Collector Controller stop.
 - b. If the NSP Flow Collector is on a dedicated station, enter the following:
`bash$./fc/bin/flowCollector.bash stop ↵`
The NSP Flow Collector stops.
- 5** _____
To start the NSP Flow Collector, perform one of the following:
- a. If the NSP Flow Collector is collocated with an NSP Flow Collector Controller, enter the following:
`bash$./fcc/bin/flowCollectorController.bash start ↵`
The NSP Flow Collector and NSP Flow Collector Controller start.
 - b. If the NSP Flow Collector is on a dedicated station, enter the following:
`bash$./fc/bin/flowCollector.bash start ↵`
The NSP Flow Collector starts.
- 6** _____
Close the console window.

END OF STEPS _____

19.9 How do I display the NSP Flow Collector status or release level?

19.9.1 Purpose

The following steps describe how to view the operational status or software release of an NSP Flow Collector that is on a dedicated station, or collocated with an NSP Flow Collector Controller.

19.9.2 Steps

1

Log in as the nsp user on the NSP Flow Collector station.

2

Open a console window.

3

Enter the following:

```
bash$ cd /opt/nsp/flow ↵
```

4

To display the NSP Flow Collector status, perform one of the following:

- a. If the NSP Flow Collector is collocated with an NSP Flow Collector Controller, enter the following:

```
bash$ ./fcc/bin/flowCollectorController.bash status ↵
```

The NSP Flow Collector Controller and Flow Collector status information is displayed.

- b. If the NSP Flow Collector is on a dedicated station, enter the following:

```
bash$ ./fc/bin/flowCollector.bash status ↵
```

The NSP Flow Collector status is displayed.

If the NSP Flow Collector is running, the line that begins with flow-collector includes Started.

If the NSP Flow Collector is not running, the following is displayed:

```
nspos-karaf.service is not running
```

5

To display the NSP Flow Collector release level, perform one of the following.

- a. If the NSP Flow Collector is collocated with an NSP Flow Collector Controller, enter the following:

```
bash$ ./fcc/bin/flowCollectorController.bash version ↵
```

The NSP Flow Collector Controller and Flow Collector release level is displayed.

- b. If the NSP Flow Collector is on a dedicated station, enter the following:

```
bash$ ./fc/bin/flowCollector.bash version ↵
```

The NSP Flow Collector release level is displayed.

6

Close the console window.

END OF STEPS

19.10 Workflow: configure flow statistics collection

19.10.1 Stages

- 1 _____
Open the NSP Flow Collector web UI; see [19.11 “How do I open the NSP Flow Collector web UI?”](#) (p. 443) .
- 2 _____
Specify the NEs from which to collect flow statistics; see [19.12 “How do I specify the NEs and MDAs for flow statistics collection”](#) (p. 444).
- 3 _____
Specify whether the statistics in a domain are to be stored for NSP Analytics use, or forwarded to a file server; see [19.13 “How do I configure the AA flow data persistence?”](#) (p. 445).
- 4 _____
Configure the aggregation parameters; see [19.14 “How do I configure flow statistics aggregation?”](#) (p. 445).
- 5 _____
If required, configure the transfer of collected flow statistics to a remote server; see [19.15 “How do I configure the transfer of result files?”](#) (p. 446).
- 6 _____
If required, specify the transfer options for statistics files in CSV format; see [19.16 “How do I configure CSV file compression and renaming?”](#) (p. 447).
- 7 _____
Configure a special-study policy, if required; see [19.17 “How do I configure an AA Cflowd special-study policy?”](#) (p. 448).
- 8 _____
Configure AA application or protocol filters as required; see [19.18 “How do I configure an AA application or protocol filter?”](#) (p. 449).

19.11 How do I open the NSP Flow Collector web UI?

19.11.1 Steps

- 1 _____
Use a browser to open the following URL:
`https://server:8443/fc/admin`

where *server* is the NSP Flow Collector IP address or hostname

2

If a login form opens, enter the required user credentials and click OK. The NSP Flow Collector page opens.

END OF STEPS

19.12 How do I specify the NEs and MDAs for flow statistics collection

19.12.1 Steps

1

Open the NSP Flow Collector web UI. The Collection Policy page is displayed.

2

Add NEs and IS-AA MDAs, as required.

1. Click Add. A new table row is displayed.

2. Configure the following parameters:

- System ID

The System ID value must match the System ID that the NFM-P associates with the NE, for example, as shown on the NE properties form in the GUI.

You can specify multiple MDAs on one NE by adding one table row for each MDA and using the same System ID in each row.

- Source IPFIX Address

The Source IPFIX Address value is the NE address specified in the discovery rule for the NE. This address will be used to send IPFIX traffic to the NSP Flow Collector.

- Description

3. If the NSP Flow Collector is to collect system Cflowd statistics, configure the following parameters:

- Port
- Flow Protocol



Note: For system Cflowd statistics, the combination of System ID, Source IPFIX Address, and Port must be unique.

3

To delete an NE, select the Delete on save check box beside the NE.

4

Click Save Configuration. The configuration is saved.

END OF STEPS

19.13 How do I configure the AA flow data persistence?

19.13.1 Purpose

Perform this procedure to specify, for one or more AA statistics domains, whether the NFM-P retains the collected flow data for NSP Analytics reporting, forwards the data to a target file server, or both.

19.13.2 Steps

- 1 _____
Open the NSP Flow Collector web UI. The Collection Policy page is displayed.
- 2 _____
Click on the Results Persistence tab. The AA Cflowd statistics domains are listed.
- 3 _____
Select or deselect the persistence options for each statistics domain, as required.
 - Select IPDR to enable data encoding in XDR format.
 - Select Aux DB to enable data storage for use by NSP Analytics
 - Select CSV to enable data encoding in CSV format.
- 4 _____
Click Save Configuration. The persistence settings are applied.
- 5 _____
Save your changes and close the forms.

END OF STEPS _____

19.14 How do I configure flow statistics aggregation?

19.14.1 Steps

- 1 _____
Open the NSP Flow Collector web UI. The Collection Policy page is displayed.
- 2 _____
Click on the Aggregation Policy tab.
- 3 _____
Perform one of the following:
 - a. If the NSP Flow Collector is to collect system Cflowd statistics, select the required

aggregation types from the tabs in the lower panel.

- b. If the NSP Flow Collector is to collect AA statistics, select one or more statistics classes in the Subscriber Collection panel to enable aggregation for the classes.

4

Use the Interval drop-down menus in the Aggregation Intervals panel to specify the aggregation interval for each statistic type, as required.



Note: The statistics collection interval affects NSP Flow Collector performance. A larger interval results in proportionally larger files, which take longer to store and transfer.



Note: For BB NAT statistics, you must set the collection interval no higher than the following, based on the expected flow rate:

- 350 000 flows/s—1 minute
- 50 000 flows/s—5 minutes
- 25 000 flows/s—15 minutes

5

The Interval Closing Timeout parameter specifies a latency value that is applied at the end of a collection interval to ensure that any queued statistics are written to the current file. Typically, the default value of one second is adequate; configure the parameter only at the request of technical support.

6

Specify the aggregations for each statistic type, as required.

1. Click on the tab in the lower panel that corresponds to the statistic type.
2. Select or deselect aggregations, as required.

7

Click Save Configuration. The configuration is saved.

END OF STEPS

19.15 How do I configure the transfer of result files?

19.15.1 Purpose

You can enable the transfer of result files to a file server in the following formats.

- NAT
- IPDR
- CSV



Note: A minimum 1-Gbyte/s link is required between the NSP Flow Collector and the file server.



Note: SFTP transfers are considerably slower than FTP transfers.

19.15.2 Steps

1

Click on one of the following tabs:

- NAT Transfer
- IPDR Transfer
- CSV Transfer

2

Configure the parameters:

- Enable Transfer—whether file transfers are enabled
- Transfer Protocol—FTP or SFTP
- IP Address / Host name—file server address
- Port—file server port
- Location—file server directory that is to contain the files
- User—FTP or SFTP username
- Password—FTP or SFTP password

3

Click Save Configuration. The configuration is saved.

END OF STEPS

19.16 How do I configure CSV file compression and renaming?

19.16.1 Purpose

Perform this procedure to enable the following for CSV-formatted statistics output files:

- timestamp inclusion in file name
- gzip compression

19.16.2 Steps

1

Log in to the NSP Flow Collector station as the nsp user.

2

Open the following file using a plain-text editor such as vi:

`/opt/nsp/flow/fc/cfg/CfdStorage.properties`

-
- 3 _____
Locate the csv file section.
- 4 _____
To enable gzip file compression of the output files:
1. Locate the section that begins with the following:

```
# compression option for CSV files
```
 2. Set the following parameter to true, as shown below:

```
com.alu.bsx.cfd.collector.storage.disk.csv.gz=true
```
- 5 _____
To enable the addition of a timestamp as a filename prefix:
-  **Note:** The prefix format is the following:
`YYYYMMDDhhmmss_`
where `YYYYMMDDhhmmss` is the collection interval start time
1. Locate the section that begins with the following:

```
# add time prefix on transfer option for CSV files
```
 2. Set the following parameter to true, as shown below:

```
com.alu.bsx.cfd.collector.storage.disk.csv.tpot=true
```
- 6 _____
Save and close the CfdStorage.properties file.
- END OF STEPS _____

19.17 How do I configure an AA Cflowd special-study policy?

19.17.1 Steps

- 1 _____
Open the NSP Flow Collector web UI. The Collection Policy page is displayed.
- 2 _____
Click on the Special Study Policy tab.
- 3 _____
Click Add. A new table row is displayed.
- 4 _____
Configure the Filter Type parameter.

5 _____
If the Filter Type parameter is set to something other than All Traffic per Subscriber, configure the Application / Application Group Name parameter.

6 _____
Configure the Subscriber Type parameter.

7 _____
Configure the Subscriber ID parameter.

 **Note:** In the mobile domain, the subscriber ID must be prefixed by IMSI, MSISDN, or IMEI. For example, IMSI 88123398891xxxx.

8 _____
If the Subscriber Type value is SAP, SDP Binding, or Business Transit Sub, configure the System ID parameter by specifying the system IP address of the host NE.

9 _____
To delete a policy, select the Delete on save check box beside the policy.

10 _____
Click Save Configuration. The configuration is saved.

END OF STEPS _____

19.18 How do I configure an AA application or protocol filter?

19.18.1 Steps

 **Note:** You must specify only the ingress direction for Cflowd collection on interfaces.

1 _____
Open the NSP Flow Collector web UI. The Collection Policy page is displayed.

2 _____
Click on the Application / Protocol Filters tab.

3 _____
Click Add. A new table row is displayed.

4 _____
Configure the Filter Type parameter.

5 _____

Configure the Application / Protocol Name parameter.

6 _____

To delete a filter, select the Delete on save check box beside the filter.

7 _____

Click Save Configuration. The filters are applied to the next scheduled collection.

END OF STEPS _____

20 NSP auxiliary database administration

20.1 What is an NSP auxiliary database?

20.1.1 Description

An NSP auxiliary database provides additional statistics data storage, and is required for advanced storage and retrieval for functions such as NSP Analytics. An auxiliary database is deployed on one station, or as a cluster of three or more stations, depending on the scale requirements.

Auxiliary database deployment also supports geographically redundant, or geo-redundant, deployment using functionally identical auxiliary database clusters in separate data centers.

An NSP operator uses a RESTCONF API call to return the auxiliary database status, as described in [20.4 “How do I check the auxiliary database status?”](#) (p. 455).

20.1.2 Auxiliary database fault tolerance

The following provide auxiliary database fault tolerance:

- hardware redundancy, in a multi-station cluster
- geographically redundant clusters; see [“Geo-redundant deployment”](#) (p. 451)
- data replication among the stations in a multi-station cluster, and between clusters in a geo-redundant deployment
- manual and scheduled database backups

Hardware redundancy

If enough members of an auxiliary database cluster fail, the cluster is considered to be failed, and an alarm is raised. When a geo-redundant cluster fails, the local NSP cluster initiates an auxiliary database switchover, and the standby cluster assumes the primary role.

In order for a cluster to be considered failed, the number of unavailable cluster members varies by the cluster size:

- one-member cluster—one
- three-or-more-member cluster—two

Geo-redundant deployment

Auxiliary database deployment supports geo-redundancy, in which an auxiliary database cluster is deployed in each data center of a DR NSP deployment.

The auxiliary database cluster that has the primary role processes transactions and replicates the data to the standby cluster every 30 minutes.

In the event that the primary auxiliary database cluster is unreachable, the standby cluster initiates a database failover and assumes the primary role. The failover function is independent of NFM-P or NSP system redundancy functions, and is non-revertive. [17.3 “How do I perform an auxiliary](#)

[database switchover?](#) (p. 463) describes how to switch the auxiliary database cluster roles in a DR deployment, which may be required after a failover to restore the initial primary and standby cluster roles.

For more information about auxiliary database redundancy, see [17.2.1 “Auxiliary database geographic redundancy”](#) (p. 379).

i **Note:** During some internal operations, the status of one or more standby cluster members may be UNREACHABLE temporarily, and is no cause for concern.

Backups and restores

An auxiliary database backup operation backs up the database data on each auxiliary database station in the primary cluster. Scheduled backups are strongly recommended.

i **Note:** Scheduled auxiliary database backups are disabled by default.

See [20.6 “How do I schedule auxiliary database backups?”](#) (p. 458) and [20.8 “How do I perform an auxiliary database backup?”](#) (p. 460) for information.

Although an auxiliary database may be distributed among multiple stations, a database restore operation is initiated on one station, and automatically replicates the restored data among the other stations, as required.

See [20.10 “How do I restore an auxiliary database?”](#) (p. 463) for information.

Fault detection

To detect a database failure or a connectivity loss, the local NFM-P main server or NSP cluster monitors each station in the primary auxiliary database cluster. If a failure is detected, the NSP raises one of the following major or critical alarms, which are not self-clearing unless otherwise noted:

- cluster member unavailable
- database unavailable
- for geo-redundancy:
 - database proxy down (self-clearing)
 - primary cluster unreachable
 - cluster copy failure
 - activation failure
 - activation triggered.
 - standby cluster unreachable

i **Note:** The geo-redundancy alarms are NSP alarms, so are not reported by the NFM-P. The alarm information is available to subscribers of the Kafka FAULT topic, and to RESTCONF API clients, but not to NFM-P XML API clients.

20.2 How do I start an auxiliary database cluster?

20.2.1 Purpose

Perform this procedure to start the auxiliary database software on all stations in an auxiliary database cluster, for example, if the auxiliary database cluster fails to start after a power disruption.

1 _____

Log in to an auxiliary database station as the root user.

2 _____

Enter the following:

```
# /opt/nsp/nfmp/auxdb/install/bin/auxdbAdmin.sh start ↵
```

You are prompted for the database user password.

3 _____

Enter the password. The auxiliary database starts.

END OF STEPS _____

20.3 How do I stop an auxiliary database cluster?

20.3.1 Purpose



CAUTION

Service disruption

Stopping an auxiliary database cluster requires a shutdown of each associated main and auxiliary server, and may be service-affecting.

Perform the procedure only if required, and only during a scheduled maintenance period.



Note: The main and auxiliary servers named in the procedure are in the local NFM-P system that includes the auxiliary database cluster.

Perform this procedure to stop the auxiliary database software on all stations in an auxiliary database cluster, for example, for maintenance purposes.

1 _____

If the NSP deployment does not include the NFM-P, go to [Step 4](#).

2 _____

Perform the following steps on each NFM-P auxiliary server station to stop the server.

1. Log in to the station as the nsp user.
2. Open a console window.

3. Enter the following:

```
bash$ cd /opt/nsp/nfmp/auxserver/nms/bin ↵
```

4. Enter the following:

```
bash$ ./auxnmserver.bash auxstop ↵
```

5. Enter the following to display the auxiliary server status:

```
bash$ ./auxnmserver.bash auxappserver_status ↵
```

The server status is displayed; the server is fully stopped if the status is the following:

```
Auxiliary Server is stopped
```

If the server is not fully stopped, wait five minutes and then repeat this step. Do not perform the next step until the server is fully stopped.

3

Perform the following steps on each NFM-P main server station to stop the server.

i **Note:** In a redundant system, you must perform the steps on the standby main server first.

1. Log in to the station as the nsp user.
2. Open a console window.
3. Enter the following:

```
bash$ cd /opt/nsp/nfmp/server/nms/bin ↵
```

4. Enter the following

```
bash$ ./nmserver.bash stop ↵
```

5. Enter the following to display the NFM-P server status:

```
bash$ ./nmserver.bash appserver_status ↵
```

The server status is displayed; the server is fully stopped if the status is the following:

```
Application Server is stopped
```

If the server is not fully stopped, wait five minutes and then repeat this step. Do not perform the next step until the server is fully stopped.

4

Log in to any auxiliary database station in the cluster as the root user.

5

Enter the following:

```
# /opt/nsp/nfmp/auxdb/install/bin/auxdbAdmin.sh stop ↵
```

You are prompted to enter the database user password.

6

Enter the password. The auxiliary database stops.

-
- 7 _____
Close the console window.

END OF STEPS _____

20.4 How do I check the auxiliary database status?

20.4.1 Purpose

Perform this procedure to obtain the current fstatus of the auxiliary database clusters in an NSP deployment.

20.4.2 Steps

- 1 _____
Log in to a station that has access to the NSP system.

- 2 _____
Open a console window.

- 3 _____
Issue the following RESTCONF API call:

i **Note:** In order to issue a RESTCONF API call, you require a token; see the My First NSP API Client tutorial on the [Network Developer Portal](#) for information.

GET https://address/restconf/data/auxdb:/clusters

where *address* is the NSP advertised address

The call returns auxiliary database cluster status information like the following:

```
<HashMap>
  <clusters>
    <cluster>
      <name>cluster_1</name>
      <mode>ACTIVE</mode>
      <status>UP</status>
      <nodes>
        <external-ip>203.0.113.101</external-ip>
        <internal-ip>10.1.2.101</internal-ip>
        <status>UP</status>
      </nodes>
    </nodes>
    <nodes>
      <external-ip>203.0.113.102</external-ip>
```

```
<internal-ip>10.1.2.102</internal-ip>
  <status>UP</status>
</nodes>
<nodes>
  <external-ip>203.0.113.103</external-ip>
  <internal-ip>10.1.2.103</internal-ip>
  <status>UP</status>
</nodes>
</cluster>
<cluster>
  <name>cluster_2</name>
  <mode>STANDBY</mode>
  <status>ON_STANDBY</status>
  <nodes>
    <external-ip>203.0.113.104</external-ip>
    <internal-ip>10.1.2.104</internal-ip>
    <status>READY</status>
  </nodes>
  <nodes>
    <external-ip>203.0.113.105</external-ip>
    <internal-ip>10.1.2.105</internal-ip>
    <status>READY</status>
  </nodes>
  <nodes>
    <external-ip>203.0.113.106</external-ip>
    <internal-ip>10.1.2.106</internal-ip>
    <status>READY</status>
  </nodes>
</cluster>
</clusters>
</HashMap>
```

4

View each status value.



Note: The *cluster_1* and *cluster_2* addresses correspond to the *ipList* and *standbyIpList* parameter values in the **auxDb** section of the NSP cluster configuration file.

5 _____
If each status value is not READY, contact technical support.

6 _____
Close the console window.

END OF STEPS _____

20.5 How do I change the samauxdb RHEL user password?

20.5.1 Purpose

Perform this procedure to change the password of the samauxdb RHEL user on an auxiliary database station.

 **Note:** You must set the password to the same value on each auxiliary database station.

20.5.2 Steps

1 _____
Log in to the auxiliary database station as the samauxdb user.

2 _____
Open a console window.

3 _____
Enter the following:
`# passwd ↵`
The following prompt is displayed:
New Password:

4 _____
Enter the new password and press ↵.
The following prompt is displayed:
Confirm New Password:

5 _____
Enter the new password again and press ↵. The password is changed.

6 _____
Record the new password and store it in a secure location.

7 _____
Close the console window.

8 _____
Log out of the station.

END OF STEPS _____

20.6 How do I schedule auxiliary database backups?



CAUTION

Service Disruption

Consider the directory path when you configure the Backup Location parameter.

You must specify the absolute path of a directory in a partition other than the partition that contains the database data.

i **Note:** An auxiliary database backup fails unless all members of the local auxiliary database cluster are operational and available.

20.6.1 Steps

1 _____
Record the current auxiliary database administrator password and store it in a secure location for safekeeping.

The password is required if you change a database user password and then subsequently need to restore the database.

i **Note:** If you subsequently change the administrator password, ensure that you update the recorded password.

2 _____
Log in to a station that has access to the NSP cluster.

3 _____
Open a console window.

4 _____
Issue the following RESTCONF API call to create the scheduled backup scheme:

i **Note:** In order to issue a RESTCONF API call, you require a token; see the My First NSP API Client tutorial on the [Network Developer Portal](#) for information.

POST `https://address/restconf/data`

where

address is the NSP advertised address

The request body is the following:

```
{
  "nsp-auxdb-backup:config": {
    "backup-location": "path",
    "backups-to-keep": max_backups,
    "enabled": true,
    "interval": 2,
    "sync-time": first_run
  }
}
```

where

path is the directory in which to store the backup files, typically `/opt/nsp/nfmp/auxdb/backup`

max_backups is the number of previous backups to retain; the range is 0 to 7, and the default is 2

interval is how often a backup is performed, in hours

first_run is the Unix epoch time at which the first backup is to occur; marks the start of the schedule defined by *interval*

Auxiliary database backups are scheduled to occur every *interval* hours beginning at the *first_run* time.

5

To view the status of a backup operation, perform [20.7 “How do I check the auxiliary database backup status?”](#) (p. 459) as required.

6

Close the console window.

END OF STEPS

20.7 How do I check the auxiliary database backup status?

20.7.1 Purpose

Perform this procedure to learn the status of the most recently invoked auxiliary database backup.

20.7.2 Steps

1

Log in to a station that has access to the NSP cluster.

2 _____
Open a console window.

3 _____
Issue the following RESTCONF API call:

i **Note:** In order to issue a RESTCONF API call, you require a token; see the My First NSP API Client tutorial on the [Network Developer Portal](#) for information.

GET https://address/restconf/data/nsp-auxdb-backup:status

where *address* is the NSP advertised address

The response includes the auxiliary database backup status.

4 _____
View the status, which is one of the following:

- never_run—no initial backup performed
- running—backup in progress
- failed—backup attempt unsuccessful
- success—backup completed successfully
- unknown—status unavailable

5 _____
If the status value is failed or unknown, contact technical support to investigate.

6 _____
Close the console window.

END OF STEPS _____

20.8 How do I perform an auxiliary database backup?

20.8.1 Purpose

Perform this procedure to invoke an immediate auxiliary database backup.

i **Note:** The backup may take considerable time, depending on the amount of stored data.

20.8.2 Steps

1 _____
In order to back up an auxiliary database, all members of the local auxiliary database cluster must be operational and available, or the backup fails.

Perform [20.4 “How do I check the auxiliary database status?”](#) (p. 455) to verify that each local cluster member is operational.

-
- 2 _____
Record the current auxiliary database administrator password and store it in a secure location for safekeeping.
The password is required if you change a database user password and then subsequently need to restore the database.
 - 3 _____
Log in to a station that has access to the NSP system.
 - 4 _____
Open a console window.
 - 5 _____
Issue the following RESTCONF API call:
 **Note:** In order to issue a RESTCONF API call, you require a token; see the My First NSP API Client tutorial on the [Network Developer Portal](#) for information.
POST `https://address/restconf/operations/nsp-auxdb-backup:start-backup`
where *address* is the NSP advertised address
The auxiliary database cluster backup begins.
 - 6 _____
To view the status of the backup operation, perform [20.7 “How do I check the auxiliary database backup status?”](#) (p. 459) as required.
 - 7 _____
Close the console window.

END OF STEPS _____

20.9 How do I manage auxiliary database backups?

20.9.1 Purpose

Perform this procedure to modify, replace, or delete the auxiliary database backup scheme.

20.9.2 Steps

- 1 _____
Log in to a station that has access to the NSP cluster.
- 2 _____
Open a console window.

3

To modify the current backup scheme, issue the following RESTCONF API call:

i **Note:** In order to issue a RESTCONF API call, you require a token; see the My First NSP API Client tutorial on the [Network Developer Portal](#) for information.

PATCH `https://address/restconf/data/nsp-auxdb-backup:config`

where

address is the NSP advertised address

The request body is the following:

```
{
  "nsp-auxdb-backup:config": {
    "parameter": value,
  }
}
```

where

parameter is the name of a parameter listed in [Step 4](#)

value is the parameter value to assign

The backup scheme is modified.

4

To replace the current backup scheme, issue the following RESTCONF API call:

i **Note:** In order to issue a RESTCONF API call, you require a token; see the My First NSP API Client tutorial on the [Network Developer Portal](#) for information.

PUT `https://address/restconf/data/nsp-auxdb-backup:config`

where

address is the NSP advertised address

The request body is the following:

```
{
  "nsp-auxdb-backup:config": {
    "backup-location": "path",
    "backups-to-keep": max_backups,
    "enabled": true,
    "interval": 2,
    "sync-time": first_run
  }
}
```

where

path is the directory in which to store the backup files, typically `/opt/nsp/nfmp/auxdb/backup`

max_backups is the number of previous backups to retain; the range is 0 to 7, and the default is 2

interval is how often a backup is performed, in hours

first_run is the Unix epoch time at which the first backup is to occur; marks the start of the schedule defined by *interval*

The new backup scheme is enabled.

5



CAUTION

Data at Risk

Deleting the auxiliary database backup scheme means that no auxiliary database backup schedule is in place, and may place the auxiliary database data at risk in the event of a failure.

Ensure that you delete the auxiliary database backup scheme only for maintenance purposes, or as directed by technical support, and that you create a new backup scheme when normal database operation resumes.

To delete the current backup scheme, issue the following RESTCONF API call:



Note: In order to issue a RESTCONF API call, you require a token; see the My First NSP API Client tutorial on the [Network Developer Portal](#) for information.

DELETE `https://address/restconf/data/nsp-auxdb-backup:config`

The auxiliary database backup scheme is deleted.

6

Close the console window.

END OF STEPS

20.10 How do I restore an auxiliary database?

20.10.1 Purpose

Perform this procedure to restore an auxiliary database from an auxiliary database backup file set.



CAUTION

Service Disruption

Restoring an auxiliary database in a deployment that includes the NFM-P requires a shutdown of the NFM-P system and causes a network management outage.

Ensure that you perform this procedure only during a scheduled maintenance period.

20.10.2 Steps

Stop auxiliary database proxies

1

Stop the database proxy on each auxiliary database station.



Note: In a geo-redundant auxiliary database, you must stop the proxy on the standby auxiliary database stations first.

1. Log in as the root user on the station.

2. Enter the following:

```
# systemctl stop nspos-auxdbproxy.service ↵
```

3. Verify that the proxy is stopped; enter the following:

```
# systemctl status nspos-auxdbproxy ↵
```

2

If the NSP deployment does not include the NFM-P, go to [Step 5](#).

Stop NFM-P main and auxiliary servers

3

If the NFM-P system is redundant, stop the standby main server and the associated auxiliary servers.

1. Perform [21.7 “How do I stop an auxiliary server?” \(p. 519\)](#) to stop each Preferred and Reserved auxiliary server of the standby main server.

2. Log in to the standby main server as the nsp user.

3. Open a console window.

4. Enter the following:

```
bash$ cd /opt/nsp/nfmp/server/nms/bin ↵
```

5. Enter the following to stop the main server:

```
bash$ ./nmserver.bash stop ↵
```

6. Enter the following to display the main server status:

```
bash$ ./nmserver.bash appserver_status ↵
```

The server status is displayed; the server is fully stopped if the status is the following:

```
Application Server is stopped
```

If the server is not fully stopped, wait five minutes and then repeat this step. Do not perform the next step until the server is fully stopped.

4

Stop the standalone or primary main server and the associated auxiliary servers.

1. Perform [21.7 “How do I stop an auxiliary server?” \(p. 519\)](#) to stop each Preferred and Reserved auxiliary server of the primary or standalone main server.
2. Log in to the main server station as the nsp user.
3. Open a console window.
4. Enter the following:

```
bash$ cd /opt/nsp/nfmp/server/nms/bin ↵
```

5. Enter the following to stop the main server:

```
bash$ ./nmserver.bash stop ↵
```

6. Enter the following to display the main server status:

```
bash$ ./nmserver.bash appserver_status ↵
```

The server status is displayed; the server is fully stopped if the status is the following:

```
Application Server is stopped
```

If the server is not fully stopped, wait five minutes and then repeat this step. Do not perform the next step until the server is fully stopped.

Prepare auxiliary database stations

5

If the auxiliary database is geo-redundant, you must identify which auxiliary database cluster is currently primary.

If you do not know which cluster is currently the primary cluster, perform [20.4 “How do I check the auxiliary database status?” \(p. 455\)](#).

6

Stop the standalone or primary auxiliary database.

i **Note:** In a geo-redundant auxiliary database, you must ensure that each auxiliary database cluster is stopped before you attempt to perform a restore operation.

1. Log in as the root user on any station in the standalone or primary auxiliary database cluster.
2. Enter the following:

```
# /opt/nsp/nfmp/auxdb/install/bin/auxdbAdmin.sh stop ↵
```

You are prompted to enter the database user password.

3. Enter the password. The auxiliary database stops.

7

If the backup files to restore are not in the original backup location on each auxiliary database station, perform the following steps.

1. If you know the original backup location, go to substep 6.
2. Open the following file for viewing:

```
path/AuxDbBackUp/samAuxDbBackup_restore.conf
```

where *path* is the current location of the backup file set

3. Locate the [Mapping] section, which contains one line like the following for each auxiliary server station:

```
v_name_node0001 = IP_address:path/AuxDbBackUp
```

The *path* is the original backup location.

4. Record the original backup location.
5. Close the samAuxDbBackup_restore.conf file.
6. Copy the AuxDbBackUp directory contents from the current backup location to the AuxDbBackUp directory in the original backup location on each auxiliary database station.
7. As the root user, enter the following command on each auxiliary database station:

```
# chown -R samauxdb path ↵
```

where *path* is the absolute path of the original backup location

8

If the backup is being restored on any stations that have different internal IP addresses, perform the following steps on each auxiliary database station.

1. Open the following file using a plain-text editor such as vi:

```
path/AuxDbBackUp/samAuxDbBackup_restore.conf
```

where *path* is the location of the backup file set

2. Add the following internal mapping section to the end of the file; the example below is for an auxiliary database of three stations:

```
[NodeMapping]
```

```
v_name_node0001 = IP_address_1
```

```
v_name_node0002 = IP_address_2
```

```
v_name_node0003 = IP_address_3
```

where

v_name_node000n is the station name shown in the [Mapping] section of the file

IP_address_n is the new internal IP address of the station

3. Save and close the samAuxDbBackup_restore.conf file.

Perform auxiliary database restore operation

9

Perform one of the following on one auxiliary database station.

- a. Restore the latest backup; enter the following:

```
# /opt/nsp/nfmp/auxdb/install/bin/auxdbAdmin.sh restore  
/opt/nsp/path/AuxDbBackUp/samAuxDbBackup_restore.conf ↵
```

where *path* is the original backup directory

- b. Restore a backup other than the latest; perform the following steps.

1. Enter the following:

```
# ls path/AuxDbBackUp/.auxdb_backup_history ↵
```

where *path* is the original backup directory

The directory contents are listed; the following files are present for each previous backup:

- AuxDbBackUpID_datestamp_timestamp_samAuxDbBackup_info.txt
- AuxDbBackUpID_datestamp_timestamp_samAuxDbBackup_restore.txt

where

datestamp is the backup date, in the form YYYYMMDD

timestamp is the backup time, in the form hhmmss

ID is a unique numerical identifier

2. Based on the date and time of the backup that you want to restore, identify and record the *ID*, *datestamp*, and *timestamp* values.
3. Enter the following:

```
# /opt/nsp/nfmp/auxdb/install/bin/auxdbAdmin.sh restore  
path/AuxDbBackUp/.auxdb_backup_history/AuxDbBackUpID_datestamp_  
timestamp_samAuxDbBackup_restore.conf ↵
```

where

path is the original backup directory

ID is the recorded *ID* value

datestamp is the recorded *datestamp* value

timestamp is the recorded *timestamp* value

The restore operation begins. The following messages and progress indicators are displayed:

```
Starting full restore of database db_name.
```

```
Participating nodes: node_1, node_2, ... node_n.
```

```
Restoring from restore point: AuxDbBackUpID_datestamp_timestamp
```

```
Determining what data to restore from backup.
```

```
[=====] 100%
```

```
Approximate bytes to copy: nnnnnnnn of nnnnnnnnn total.
```

```
Syncing data from backup to cluster nodes.
```

When the restore is complete, the second progress indicator reaches 100%, and the following message is displayed:

```
[=====] 100%
```

```
Restoring catalog. Restore complete!
```

Restore database user passwords

10

If a database user password has changed since the creation of the database backup, the NSP components cannot authenticate with the restored auxiliary database.

In such a scenario, you must perform the following steps to update each affected database user password to the value that the NSP components recognize.

1. Enter the following on the current auxiliary database station to connect to the auxiliary database:

```
# vsql ↵
```

You are prompted for credentials.

2. Enter the following:
 - user—samauxdb
 - password—database administrator password recorded during creation of backup
3. Enter the following once for each user whose password has changed since the backup creation:

```
ALTER USER user IDENTIFIED BY 'password';
```

where

user is the database user name

password is the newer password recognized by the NSP

4. Verify the success of the password change by:
 - attempting to connect to the auxiliary database as each affected user
 - ensuring that the NSP components are able to connect to the auxiliary database

Start auxiliary database proxies

11

Start the auxiliary database proxy on each auxiliary database station.

 **Note:** In a geo-redundant auxiliary database, you must start the proxy on the stations of the restored auxiliary database cluster first.

1. Log in as the root user on the station.
2. Enter the following:

```
# systemctl start nspos-auxdbproxy.service ↵
```

12

If the NSP deployment does not include the NFM-P, go to [Step 15](#).

Start NFM-P servers

13

Start the standalone or primary main server and associated auxiliary servers.

1. Log in to the main server station as the nsp user.
2. Open a console window.
3. Enter the following:

```
bash$ cd /opt/nsp/nfmp/server/nms/bin ↵
```

-
4. Enter the following to start the main server:

```
bash$ ./nmsserver.bash start ↵
```

5. Enter the following:

```
bash$ ./nmsserver.bash appserver_status ↵
```

The server status is displayed; the server is fully initialized if the status is the following:

```
Application Server process is running. See nms_status for more detail.
```

If the server is not fully initialized, wait five minutes and then repeat this step. Do not perform the next step until the server is fully initialized.

6. Perform [21.6 “How do I start an auxiliary server?” \(p. 518\)](#) to start each Preferred and Reserved auxiliary server of the primary or standalone main server.

14

If the NFM-P system is redundant, start the standby main server and associated auxiliary servers.

1. Log in to the standby main server as the nsp user.
2. Open a console window.
3. Enter the following:

```
bash$ cd /opt/nsp/nfmp/server/nms/bin ↵
```

4. Enter the following to start the main server:

```
bash$ ./nmsserver.bash start ↵
```

5. Enter the following to display the main server status:

```
bash$ ./nmsserver.bash appserver_status ↵
```

The server status is displayed; the server is fully initialized if the status is the following:

```
Application Server process is running. See nms_status for more detail.
```

If the server is not fully initialized, wait five minutes and then repeat this step. Do not perform the next step until the server is fully initialized.

6. Perform [21.6 “How do I start an auxiliary server?” \(p. 518\)](#) to start each Preferred and Reserved auxiliary server of the standby main server.

15

Close the open console windows.

END OF STEPS

20.11 How do I change an auxiliary database user password?

20.11.1 Purpose

1

Log in to a station that has access to the NSP cluster.

2

Open a console window.

3

Issue the following RESTCONF API call:

i **Note:** In order to issue a RESTCONF API call, you require a token; see the My First NSP API Client tutorial on the [Network Developer Portal](#) for information.

POST `https://address/restconf/data/nsp-auxdb-user:users/user=
username/change-password`

where

address is the NSP advertised address

username is the username, for example, samauxdb, samuser, samanaltic, or samanaltic_ano

The request body is the following, in which you specify the new and current passwords:

```
{
  "nsp-auxdb-user:input" : {
    "new-password": "new_password",
    "current-password": "current_password"
  }
}
```

The following is an example of a success response:

```
{
  "nsp-auxdb-user:output": {},
  "statusCode": "OK"
}
```

4

Synchronize the auxiliary database password with the NSP cluster.

1. Log in as the root user on the NSP deployer host.
2. Open a console window.
3. Enter the following:

```
# cd  
/opt/nsp/NSP-CN-DEP-release-ID/NSP-CN-release-ID/tools/database ↵
```

4. Enter the following:

```
# ./sync-auxdb-password.bash ↵
```

Messages like the following are displayed:

```
timestamp: Synchronizing password for Auxiliary DB Output...  
timestamp: deployment.apps/tlm-vertica-output scaled  
timestamp: secret/tlm-vertica-output patched  
timestamp: deployment.apps/tlm-vertica-output scaled  
timestamp: Synchronization completed.
```

- 5

Close the console window.

END OF STEPS

20.12 How do I change the auxiliary database external IP addresses?

20.12.1 Purpose

Perform this procedure when the IP addresses that an auxiliary database uses to communicate with other NFM-P components must change, for example, when the auxiliary database moves to a different subnet, or when the protocol in use by the NFM-P components changes from IPv4 to IPv6.

i **Note:** Changing the internal IP addresses of the auxiliary database cluster members is not supported.

20.12.2 Steps

Stop NFM-P main servers, auxiliary database

- 1

Perform the following steps on each NFM-P main server station to stop the server.

i **Note:** In a redundant system, you must perform the steps on the standby main server first.

1. Log in to the station as the nsp user.
2. Open a console window.
3. Enter the following:

```
bash$ cd /opt/nsp/nfmp/server/nms/bin ↵
```

4. Enter the following

```
bash$ ./nmserver.bash stop ↵
```

5. Enter the following to display the NFM-P server status:

```
bash$ ./nmserver.bash appserver_status ↵
```

The server status is displayed; the server is fully stopped if the status is the following:

Application Server is stopped

If the server is not fully stopped, wait five minutes and then repeat this step. Do not perform the next step until the server is fully stopped.

2

Perform the following steps on each auxiliary database station.

1. Log in to the station as the root user.
2. Open a console window.
3. Enter the following:

```
# systemctl stop nspos-auxdbproxy.service ↵
```

The auxiliary database proxy service stops.

4. Open the /etc/hosts file using a plain-text editor such as vi.
5. Change the IP address that is mapped to the station hostname to the new IP address associated with the hostname.

Reconfigure addresses

3

Log in to one of the auxiliary database stations as the root user.

4

Open the /opt/nsp/nfmp/auxdb/install/config/install.config file using a plain-text editor such as vi.

5



CAUTION

Service disruption

Changing a parameter in the auxiliary database install.config file can have serious consequences that include service disruption.

Do not change any parameter in the install.config file, other than the parameters described in the steps, without guidance from technical support.

Locate the following line and change each *export_IP* value to the new IP address:

```
export_hosts=internal_IP1[export_IP1],internal_IP2[export_IP2]...internal_IPn[export_IPn]
```

6

Save and close the install.config file.

7

Enter the following on the same station:

```
# /opt/nsp/nfmp/auxdb/install/bin/auxdbAdmin.sh updateInterfaces ↵
```

The following prompt is displayed.

Please enter auxiliary database dba password [if you are doing initial setup for auxiliary database, press enter]:

8

Enter the password.

Messages like the following are displayed.

```
Dropping host public interfaces for 10.1.2.105
  Dropped interface PUBLIC_IF_10_1_2_105 on node v_samdb_node0001.
Creating public interface for host 10.1.2.105[new_external_address]
Dropping host public interfaces for 10.1.2.106
  Dropped interface PUBLIC_IF_10_1_2_106 on node v_samdb_node0002.
Creating public interface for host 10.1.2.106[new_external_address]
Dropping host public interfaces for 10.1.2.107
  Dropped interface PUBLIC_IF_10_1_2_107 on node v_samdb_node0003.
Creating public interface for host 10.1.2.107[new_external_address]
Distributing install.config to all nodes
  Output captured in /opt/nsp/nfmp/auxdb/install/log/auxdbAdmin.sh.
  timestamp.log
```

9

Perform the following steps on each auxiliary database station.

1. Log in to the station as the root user.
2. Open a console window.
3. Enter the following:

```
# systemctl start nspos-auxdbproxy.service ↵
```

The auxiliary database proxy service starts.

Update NFM-P main servers

10

Perform the following steps on each main server station.

1. Log in to the main server station as the root user.
2. Open a console window.
3. Enter the following:

```
# samconfig -m main ↵
```

4. Enter the following:

```
<main> configure auxdb ip-list address1,address2...addressN exit ↵
```

where *address1, address2...addressN* are the new IP addresses of the auxiliary database stations

5. Enter the following:

```
<main> apply ↵
```

The configuration is applied.

6. Enter the following:

```
<main> exit ↵
```

The samconfig utility closes.

Reconfigure NSP clusters

11

Perform [Step 12](#) to [Step 20](#) on the NSP cluster in each data center.

12

Log in as the root user on the NSP deployer VM.

13

Preserve the existing NSP cluster configuration.

1. Open the following file using a plain-text editor such as vi:

```
/opt/nsp/NSP-CN-DEP-release-ID/NSP-CN-release-ID/config/nsp-config.yml
```

2. Edit the following line in the **platform** section, **kubernetes** subsection to read:

```
deleteOnUndeploy:false
```

3. Save and close the file.

14

Enter the following to stop the NSP cluster:

i **Note:** If the NSP cluster VMs do not have the required SSH key, you must include the `--ask-pass` argument in the command, as shown in the following example, and are subsequently prompted for the root password of each cluster member:

```
nspdeployerctl --ask-pass uninstall --undeploy
```

```
# /opt/nsp/NSP-CN-DEP-release-ID/bin/nspdeployerctl uninstall  
--undeploy ↵
```

The cluster stops.

15

Open the following file using a plain-text editor such as vi:

```
/opt/nsp/NSP-CN-DEP-release-ID/NSP-CN-release-ID/config/nsp-config.yml
```

16

Locate the following section:

```
auxDb:
  ipList: "cluster_1_IP1,cluster_1_IP2...cluster_1_IPn"
  standbyIpList: "cluster_2_IP1,cluster_2_IP2...cluster_2_IPn"
```

17

Edit the IP addresses as required.

18

Save and close the file.

19

Enter the following to start the NSP cluster:

i **Note:** If the NSP cluster VMs do not have the required SSH key, you must include the `--ask-pass` argument in the command, as shown in the following example, and are subsequently prompted for the root password of each cluster member:

```
nspdeployerctl --ask-pass install --config --deploy
# /opt/nsp/NSP-CN-DEP-release-ID/bin/nspdeployerctl install --config
--deploy ↵
```

The NSP cluster starts, and the configuration update is put into effect.

20

Close the console window.

Start NFM-P main servers

21

Perform the following steps on each main server station to start the main server.

i **Note:** In a redundant system, you must start the primary main server first.

1. Return to the open console window on the main server station.
2. Enter the following:

```
bash$ ./nmserver.bash start ↵
```

3. Enter the following:

```
bash$ ./nmserver.bash appserver_status ↵
```

The server status is displayed; the server is fully initialized if the status is the following:

```
Application Server process is running. See nms_status for more
detail.
```

If the server is not fully initialized, wait five minutes and then repeat this step. Do not perform the next step until the server is fully initialized.

22 _____
Close the open console windows.

END OF STEPS _____

20.13 How do I test auxiliary database disk performance?

20.13.1 Purpose

The disk performance of an NFM-P component affects overall system performance, and must meet or exceed the minimum specifications in the response to the NFM-P Platform Sizing Request for your system.

Also, before you add capacity to a disk or partition on an NFM-P component, for example, using LVM, you must ensure that the disk throughput and latency values remain within tolerance, which is defined as being within 10% of the current values.

 **Note:** The disk performance of the stations in an auxiliary database cluster must be closely matched. You must test and compare the disk performance of each station in a cluster to ensure optimal performance.

Perform this procedure to check the disk performance of an NSP auxiliary database station.



CAUTION

Service Disruption

Checking the disk performance requires a shutdown of the auxiliary database cluster and is service-affecting.

Perform the procedure only during a scheduled maintenance period.

20.13.2 Steps

1 _____
Perform [20.3 "How do I stop an auxiliary database cluster?"](#) (p. 453).

2 _____
When the auxiliary database cluster is stopped, enter the following as the root user on the auxiliary database station to begin the test:

```
# /opt/vertica/bin/vioperf /opt/nsp/nfmp/auxdb/data ↵
```

3 _____
Record the utility output.

4 _____
As a routine performance check, perform the following steps.

1. Compare the following recorded values with the values specified for your auxiliary database deployment:
 - Read
 - Write
 - Rewrite
 - %IO Wait
2. If the values do not meet the minimum specifications, contact technical support.
3. Go to [Step 6](#).

5

If you are adding capacity to a disk or partition, perform the following steps.

1. Add the required capacity to the disk or partition.
2. Repeat [Step 2](#) and [Step 3](#) as required.
3. Compare the following values from before and after the capacity increase:
 - Read
 - Write
 - Rewrite
 - %IO Wait
4. If the values differ by more than 10%, contact technical support.

6

Close the console windows.

END OF STEPS

20.14 How do I add an auxiliary database station?

20.14.1 Purpose

The following steps describe how to add a new station to an auxiliary database, for example, to accommodate network growth.



CAUTION

Service Disruption

This procedure requires a restart of each NFM-P main server, so is service-affecting.

Perform this procedure only during a scheduled maintenance period.



Note: You cannot add a station to a one-station auxiliary database.



Note: The primary and standby auxiliary database clusters in a geo-redundant deployment require the same number of stations.

20.14.2 Steps

Install software

1

Add a hostname entry for the new station to the `/etc/hosts` file on each existing auxiliary database station.



Note: The hostname must be the fully qualified hostname, and not the short hostname.



Note: Hostnames are case-sensitive.

2

Log in as the root user on the new auxiliary database station.

3

Add a hostname entry for the new station to the `/etc/hosts` file on the new station using the following criteria.

- The first entry for the station hostname in the file must be the station IP address that is reachable by each main server and NSP cluster.
- The hostname must be the fully qualified hostname, and not the short hostname.
- The hostname must:
 - contain only ASCII alphanumeric and hyphen characters.
 - not begin or end with a hyphen.
 - not begin with a number.
 - comply with the format defined in IETF RFC 1034.
 - use period characters delimit the FQDN components.
 - not exceed 63 characters.



Note: Hostnames are case-sensitive.

4

Perform “To apply the RHEL 8 swappiness workaround” in the *NSP Installation and Upgrade Guide* on the station.

5

Download the following installation files to an empty local directory:



Note: You must ensure that the directory is empty.



Note: The software release must match the software release of the existing auxiliary database.

- `nspos-auxdb-R.r.p-rel.v.rpm`
- `VerticaSw_PreInstall.sh`

- nspos-jre-*R.r.p*-rel.v.rpm
- vertica-*R.r.p*-rel.tar

where

R.r.p is the NSP release identifier, in the form *MAJOR.minor.patch*

v is a version number

i **Note:** In subsequent steps, the directory is called the software directory.

6 _____
Open a console window.

7 _____
Navigate to the software directory.

i **Note:** The directory must contain only the installation files.

8 _____
Enter the following:

```
# chmod +x * ↵
```

9 _____
Enter the following:

```
# ./VerticaSw_PreInstall.sh ↵
```

The script displays configuration messages like the following, and a prompt:

```
INFO: About to set kernel parameters in /etc/sysctl.conf...
INFO: Completed setting kernel parameters in /etc/sysctl.conf...
INFO: About to change the current values of the kernel parameters
INFO:
Completed changing the current values of the kernel parameters
INFO: About to set ulimit parameters in /etc/security/limits.conf...
INFO: Completed setting ulimit parameters in /etc/security/limits.
conf...
Checking Vertica DBA group samauxdb...
Adding Vertica DBA group samauxdb...
Checking Vertica user samauxdb...
Adding samauxdb...
Set password for samauxdb...
New password:
```

10

Enter a password that conforms to the RHEL password criteria.

The following prompt is displayed:

```
Retype new password:
```

11

Re-enter the password.

Messages like the following are displayed:

```
Changing password for user samauxdb.
```

```
passwd: all authentication tokens updated successfully.
```

```
Changing ownership of the directory /opt/nsp/nfmp/auxdb to  
samauxdb:samauxdb.
```

```
Adding samauxdb to sudoers file.
```

```
Changing ownership of /opt/nsp/nfmp/auxdb files.
```

```
INFO: About to add setting to /etc/rc.d/rc.local...
```

```
INFO: Completed adding setting to /etc/rc.d/rc.local...
```

12

If the script instructs you to perform a restart, perform the following steps.

1. Enter the following:

```
# systemctl reboot ↵
```

The station restarts.

2. Log in to the station as the root user.

3. Open a console window.

4. Navigate to the software directory.

13

Enter the following:

```
# tar xvf vertica-R.r.p-rel.tar $(tar tf vertica-R.r.p-rel.tar | sort  
-V | tail -1) ↵
```

14

Enter the following:

```
# dnf install *.rpm ↵
```

The dnf utility resolves any package dependencies, and displays the following prompt:

```
Total size: nn G
```

```
Installed size: nn G
```

```
Is this ok [y/d/N]:
```

15

Enter y. The following and the installation status are displayed as each package is installed:

```
Downloading Packages:
Running transaction check
Transaction check succeeded.
Running transaction test
Transaction test succeeded.
Running transaction
```

The package installation is complete when the following is displayed:

```
Complete!
```

Add new station to auxiliary database configuration

16

When the package installation is complete, perform the following steps on each auxiliary database station to stop the database proxy.

i **Note:** If the auxiliary database is geo-redundant, you must stop the database proxy on each station in each auxiliary database cluster.

1. Log in to the station as the root user.
2. Open a console window.
3. Enter the following:

```
# systemctl stop nspos-auxdbproxy.service ↵
```
4. Verify that the proxy is stopped; enter the following:

```
# systemctl status nspos-auxdbproxy ↵
```

17

Log in to an existing auxiliary database station as the root user.

i **Note:** If the auxiliary database is geo-redundant, the station must be in the primary auxiliary database cluster.

18

Open a console window.

19

Enter the following:

```
# /opt/nsp/nfmp/auxdb/install/bin/auxdbAdmin.sh addNode internal_IP
external_IP ↵
where
```

internal_IP is the IP address from which the station communicates with the other auxiliary database stations

external_IP is the IP address from which the station communicates with other components in the deployment

The script displays the following:

```
Adding hosts(s) hostname to auxiliary database cluster ...
```

20

You are prompted to enter the auxiliary database dba password.

Enter the samauxdb database administrator password.

21

You are prompted to enter the root user password for the new station.

Enter the password of the root user account on the new station.

22



CAUTION

Installation Failure

If the addition of the station to the auxiliary database is interrupted, the operation fails and support intervention may be required.

You must answer yes to the prompt described in this step.

If the auxiliary database contains a large amount of data, the addition of the station may take considerable time. In such a scenario, the following prompt is displayed:

```
Do you want to continue waiting? (yes/no) [yes]
```

Press ↵ to accept the default of yes.



Note: The prompt may be displayed several times during the operation.

23

When the script execution is complete, open the `/opt/nsp/nfmp/auxdb/install/config/install.config` file using a plain-text editor such as `vi`.

24



CAUTION

Service Disruption

Changing a parameter in the auxiliary database `install.config` file can have serious consequences that include service disruption.

Do not change any parameter in the `install.config` file, other than the parameters described in the step, without guidance from technical support.

Edit the following line in the file to read:

```
hosts=internal_IP1,internal_IP2...internal_IPn,new_internal_IP
```

where

internal_IP1,internal_IP2...internal_IPn are the IP addresses of the existing auxiliary database stations

new_internal_IP is the IP address from which the new station communicates with the other auxiliary database stations

25

Edit the following line in the file to read:

```
export_hosts=internal_IP1[export_IP1],internal_IP2[export_IP2]...internal_IPn[export_IPn],new_internal_IP[new_export_IP]
```

where

internal_IP1[export_IP1],internal_IP2[export_IP2],internal_IPn[export_IPn] are the IP addresses of the existing auxiliary database stations

new_internal_IP is the IP address from which the new station communicates with the other auxiliary database stations

new_export_IP is the IP address from which the new station communicates with the NFM-P servers

26

Save and close the `install.config` file.

Initialize auxiliary database

27

Enter the following:

```
# ./auxdbAdmin.sh distributeConfig ↵
```

The updated auxiliary database configuration is distributed to each auxiliary database station.

Start auxiliary database proxies

28

Perform the following steps on the existing and new auxiliary database stations to start the database proxy.

1. Log in to the station as the root user.
2. Open a console window.
3. Enter the following:

```
# systemctl start nspos-auxdbproxy.service ↵
```

The auxiliary database proxy starts.

Rebalance cluster

29

Return to the existing auxiliary database station that you configured in [Step 17](#) to [Step 27](#).

30

Enter the following:

```
# ./auxdbAdmin.sh rebalance ↵
```

The following prompt is displayed:

```
Please enter auxiliary database dba password [if you are doing initial
setup for auxiliary database, press enter]:
```

31

Enter the database user password.

The following messages and prompt are displayed:

```
KSAFE factor of 1 detected
```

```
Rebalance was started in the background. Please don't reboot system
until rebalance is completed.
```

```
You can track the rebalance process by typing 'ps -fe | grep
rebalance'. Rebalance can take a very long time on large databases.
Please be patient.
```

```
Type YES to continue
```

32



CAUTION

Data corruption

Interrupting the rebalance operation can cause data corruption.

Do not interrupt the operation by, for example, rebooting the station.

Enter YES.

The rebalance operation begins, and the following is displayed:

```
Output captured in /opt/nsp/nfmp/auxdb/install/log/auxdbAdmin.sh.  
timestamp.log
```

where *timestamp* is the start time of the rebalance operation

33

Monitor the rebalance operation; do not proceed to the next step until the operation is complete.

 **Note:** A rebalance operation on a large database may take several hours.

Enter the following periodically to identify whether the rebalance process is active:

```
# ps -ef | grep rebalance ↵
```

If the rebalance process is active, two lines of output are displayed. If the rebalance is complete, only one line like the following is displayed:

```
root      nnnnn  nnnn  0 hh:mm pts/0    00:00:00 grep --color=auto  
rebalance
```

34

When the rebalance is complete, if the auxiliary database is not geo-redundant, go to [Step 41](#).

Update standby auxiliary database configuration

35

Log in to an existing standby auxiliary database station as the root user.

36

Open a console window.

37

Perform [Step 19](#) to [Step 33](#).

38

Stop the standby auxiliary database; enter the following on an existing standby auxiliary database station:

```
# ./auxdbAdmin.sh stop ↵
```

39

Enter the following on each standby auxiliary database station to start the database proxy:

```
# systemctl start nspos-auxdbproxy.service ↵
```

40

If the NSP deployment does not include the NFM-P, go to [Step 44](#).

Configure NFM-P main servers

41



CAUTION

Misconfiguration Risk

If you alter the original IP-address assignments, or the order of the IP addresses, the station addition fails.

Do not change any of the original auxiliary database station IP address assignments, or the address order, in the main server configuration.

In a geo-redundant auxiliary database deployment, the order of the IP addresses must match in each main server configuration in each data center.

Perform the following steps on each main server station.



Note: In a geo-redundant system, you must perform the steps on the main servers in each data center.



Note: In a redundant system, you must perform the steps on the standby main server station first.

1. Log in to the main server station as the nsp user.
2. Open a console window.
3. Enter the following:

```
bash$ cd /opt/nsp/nfmp/server/nms/bin ↵
```

4. Enter the following:

```
bash$ ./nmserver.bash stop ↵
```

5. Enter the following:

```
bash$ ./nmserver.bash appserver_status ↵
```

The server status is displayed; the server is fully stopped if the status is the following:

```
Application Server is stopped
```

If the server is not fully stopped, wait five minutes and then repeat this step. Do not perform the next step until the server is fully stopped.

6. Enter the following to switch to the root user:

```
bash$ su ↵
```

7. Enter the following:

```
# samconfig -m main ↵
```

The following is displayed:

```
Start processing command line inputs...
```

```
<main>
```

8. Enter the following:

Note: For a geo-redundant auxiliary database, the order of the IP addresses must be the same on each main server in each data center.

```
<main> configure auxdb ip-list IP_list exit ↵
```

where

IP_list is a list of the IP addresses in the following format:

```
cluster_1_IP1,cluster_1_IP2,cluster_1_IPn,cluster_1_new_IP;cluster_2_IP1,cluster_2_IP2,cluster_2_IPn,cluster_2_new_IP
```

where *new_IP* is the external IP address of the new station

Note: The format example shows the new address added to *cluster_1*; *cluster_2* addresses are present only for a geo-redundant auxiliary database. Ensure that you add *new_IP* to the address list for the appropriate cluster.

9. Enter the following:

```
<main> apply ↵
```

The configuration is applied.

10. Enter the following:

```
<main> exit ↵
```

The samconfig utility closes.

11. Enter the following to switch back to the nsp user:

```
# exit ↵
```

Start NFM-P main servers

42

On the standalone or primary main server station, enter the following to start the main server:

```
bash$ ./nmserver.bash start ↵
```

The main server starts, and the station is added to the auxiliary database.

43

If the NFM-P system is redundant, enter the following on the standby main server station to start the main server:

```
bash$ ./nmserver.bash start ↵
```

The main server starts.

Configure NSP clusters

44

Log in as the root user on the NSP deployer host.

45

Open the following file using a plain-text editor such as vi:

```
/opt/nsp/NSP-CN-DEP-release-ID/NSP-CN-release-ID/nsp-config.yml
```

46

Locate the following section:

```
auxDb:
  secure: "value"
  ipList: ""
  standbyIpList: ""
```

47

Edit the section to include the new auxiliary database station address, and to specify whether TLS is enabled, as shown below:



Note: You must preserve the leading spaces in each line.

```
auxDb:
  secure: "value"
  ipList: "cluster_1_IP1,cluster_1_IP2 ... cluster_1_IPn"
  standbyIpList: "cluster_2_IP1,cluster_2_IP2 ... cluster_2_IPn"
```

where

cluster_1_IP1, cluster_1_IP2...cluster_1_IPn are the external IP addresses of the stations in the local cluster, including the new station address

cluster_2_IP1, cluster_2_IP2,cluster_2_IPn are the external IP addresses of the stations in the peer cluster, including the new station address; required only for geo-redundant deployment

48

Save and close the nsp-config.yml file.

49

Enter the following to put the changes into effect:



Note: If the NSP cluster VMs do not have the required SSH key, you must include the `--ask-pass` argument in the command, as shown in the following example, and are subsequently prompted for the root password of each cluster member:

```
nspdeployerctl --ask-pass install --config --deploy
```

```
# /opt/nsp/NSP-CN-DEP-release-ID/bin/nspdeployerctl install --config
--deploy ↵
```

The NSP configuration is updated.

50

Enter the following:

```
# kubectl get pods -A ↵
```

The pods are listed.

51

Locate the auxiliary database pod entry, which resembles the following:

```
namespace      nspos-auxdb-agent-pod_ID      1/1      Running
0              uptime
```

52

Enter the following:

```
# kubectl delete pod nspos-auxdb-agent-pod_ID -n namespace ↵
```

where

namespace is the namespace of the pod entry in [Step 51](#)

pod_ID is the pod ID of the auxiliary database pod entry in [Step 51](#)

The pod is deleted and recreated to include the new station.

53

Close the open console windows.

END OF STEPS

20.15 How do I replace an auxiliary database station?

20.15.1 Purpose

Perform this procedure to replace an auxiliary database station with a station that has the same IP address, for example, after a hardware failure.

1

Log in as the root user on the replacement auxiliary database station.

2

Transfer the following auxiliary database installation files to an empty directory on the auxiliary database station:

 **Note:** You must ensure that the directory is empty.

 **Note:** In subsequent steps, the directory is called the software directory.

- nspos-auxdb-*R.r.p-rel.v*.rpm
- VerticaSw_PreInstall.sh
- nspos-jre-*R.r.p-rel.v*.rpm
- vertica-*R.r.p-rel*.tar

where

R.r.p is the NSP release identifier, in the form *MAJOR.minor.patch*
v is a version number

3 _____
Open a console window.

4 _____
Navigate to the software directory.

 **Note:** The directory must contain only the installation files.

5 _____
Enter the following:

```
# chmod +x * ↵
```

6 _____
Enter the following:

```
# ./VerticaSw_PreInstall.sh ↵
```

The script displays configuration messages like the following, and a prompt:

```
INFO: About to set kernel parameters in /etc/sysctl.conf...
INFO: Completed setting kernel parameters in /etc/sysctl.conf...
INFO: About to change the current values of the kernel parameters
INFO:
Completed changing the current values of the kernel parameters
INFO: About to set ulimit parameters in /etc/security/limits.conf...
INFO: Completed setting ulimit parameters in /etc/security/limits.
conf...
Checking Vertica DBA group samauxdb...
Adding Vertica DBA group samauxdb...
Checking Vertica user samauxdb...
Adding samauxdb...
Set password for samauxdb...
New password:
```

7 _____
Enter the samauxdb password.
The following prompt is displayed:
Retype new password:

8

Re-enter the password.

Messages like the following are displayed:

```
Changing password for user samauxdb.  
passwd: all authentication tokens updated successfully.  
Changing ownership of the directory /opt/nsp/nfmp/auxdb to  
samauxdb:samauxdb.  
Adding samauxdb to sudoers file.  
Changing ownership of /opt/nsp/nfmp/auxdb files.  
INFO: About to add setting to /etc/rc.d/rc.local...  
INFO: Completed adding setting to /etc/rc.d/rc.local...
```

9

If the script instructs you to perform a restart, perform the following steps.

1. Enter the following:

```
# systemctl reboot ↵
```

The station reboots.
2. When the reboot is complete, log in to the station as the root user.
3. Open a console window.
4. Navigate to the software directory.

10

Enter the following:

```
# tar xvf vertica-R.r.p-rel.tar $(tar tf vertica-R.r.p-rel.tar | sort  
-V | tail -1) ↵
```

11

Enter the following:

```
# dnf install *.rpm ↵
```

The dnf utility resolves any package dependencies, and displays the following prompt:

```
Total size: nn G  
Installed size: nn G  
Is this ok [y/d/N]:
```

12

Enter y. The following and the installation status are displayed as each package is installed:

```
Downloading packages:  
Running transaction check
```

```
Running transaction test
Transaction test succeeded
Running transaction
The package installation is complete when the following is displayed:
Complete!
```

13

Perform the following steps on each auxiliary database station.

1. Log in to the station as the root user.
2. Open a console window.
3. Enter the following:

```
# rm -f ~root/.ssh/known_hosts ↵
```

4. Enter the following:

```
# rm -f ~samauxdb/.ssh/known_hosts ↵
```

14

Log in to an existing auxiliary database station as the root user.



Note: The station must be an auxiliary database station other than the station that you are replacing.

15

Open a console window.

16

Open the `/etc/security/limits.conf` file for viewing.

17

Copy the following lines:

```
# The following 1 line added by Vertica tools. timestamp
samauxdb - nice value
# The following 1 line added by Vertica tools. timestamp
samauxdb - nofile value
```

18

Close the file.

19

Transfer the copied lines to the new station.

1. Log in as the root user on the replacement station.

-
2. Open the `/etc/security/limits.conf` file using a plain-text editor such as `vi`.
 3. Paste in the lines copied in [Step 17](#) at the end of the file.
 4. Close the file.
 5. Enter the following to reboot the replacement station:

```
# systemctl reboot ↵
```

20

When the station reboot is complete, enter the following on an existing auxiliary database station:

```
# /opt/nsp/nfmp/auxdb/install/bin/auxdbAdmin.sh recoverNode  
internal_IP ↵
```

where `internal_IP` is the internal auxiliary database IP address of the failed station

21

You are prompted to enter the auxiliary database dba password.

Enter the `samauxdb` password.

22

You are prompted to enter the root user password for the replacement station.

Enter the password of the root user account on the replacement station.

23

Log in to the replacement station as the root user.

24

Open a console window.

25

Enter the following:

```
# systemctl start nspos-auxdbproxy.service ↵
```

Messages like the following are displayed:

```
hh:mm:ss Day mm/dd/yy : Starting NSP Auxiliary DB Proxy ...
```

```
hh:mm:ss Day mm/dd/yy : Refer to log_file for startup status.
```

The replacement station initializes, and the data is rebalanced among the auxiliary database stations.

26

Close the open console windows.

END OF STEPS

20.16 How do I remove an auxiliary database station?

20.16.1 Purpose

Perform this procedure to remove a station from an auxiliary database.



CAUTION

Service Disruption

This procedure requires a restart of each main server, which is service-affecting.

Perform this procedure only during a scheduled maintenance period.

i **Note:** If the auxiliary database is geo-redundant, the primary and standby clusters must have the same number of stations; if you remove a station from one cluster, you must also remove a station from the other cluster.

i **Note:** *release-ID* in a file path has the following format:
R.r.p-rel.version
where
R.r.p is the NSP release, in the form *MAJOR.minor.patch*
version is a numeric value

20.16.2 Steps

1

If the auxiliary database is geo-redundant, you must identify which auxiliary database cluster is currently primary.

If you do not know which cluster is currently the primary cluster, perform [20.4 “How do I check the auxiliary database status?”](#) (p. 455).

Stop auxiliary database proxies

2

Perform the following steps on each auxiliary database station.

i **Note:** If the auxiliary database is geo-redundant, you must stop the database proxy on each station in each auxiliary database cluster.

1. Log in to the station as the root user.
2. Open a console window.
3. Enter the following:

```
# systemctl stop nspos-auxdbproxy.service ↵
```
4. Verify that the proxy is stopped; enter the following:

```
# systemctl status nspos-auxdbproxy ↵
```

Remove station from standalone or primary cluster

3

Log in to the auxiliary database station as the root user.

4

Open a console window.

5

Enter the following:

```
# cd /opt/nsp/nfmp/auxdb/install/bin ↵
```

6

Enter the following to block external access to the auxiliary database ports:

```
./auxdbAdmin.sh shieldsUp ↵
```

7

Enter the following to stop the auxiliary database:

```
./auxdbAdmin.sh force_stop ↵
```

8

Enter the following to start the auxiliary database:

```
./auxdbAdmin.sh start ↵
```

9

Enter the following:

```
# ./auxdbAdmin.sh removeNode internal_IP ↵
```

where *internal_IP* is the IP address that the station uses to communicate with the other auxiliary database stations

You are prompted for the database user password.

10

Enter the password.

The removal operation begins.



Note: If a cluster rebalance is required, the operation may take considerable time, depending on the volume of data in the auxiliary database.
The station is removed from the auxiliary database.

11

If the NSP deployment does not include the NFM-P, or is geo-redundant, go to [Step 13](#).

Reconfigure NFM-P, standalone auxiliary database

12

If the NSP deployment includes the NFM-P, perform the following steps on each NFM-P main server station.

i **Note:** In a redundant NFM-P deployment, you must perform the steps on the standby main server station first.

1. Log in to the station as the nsp user.
2. Open a console window.
3. Enter the following:

```
bash$ cd /opt/nsp/nfmp/server/nms/bin ↵
```

4. Enter the following:

```
bash$ ./nmserver.bash stop ↵
```

5. Enter the following:

```
bash$ ./nmserver.bash appserver_status ↵
```

The server status is displayed; the server is fully stopped if the status is the following:

```
Application Server is stopped
```

If the server is not fully stopped, wait five minutes and then repeat this step. Do not perform the next step until the server is fully stopped.

6. Enter the following to switch to the root user:

```
bash$ su - ↵
```

7. Enter the following:

```
# samconfig -m main ↵
```

8. Enter the following:

```
<main> configure auxdb ip-list station_1_IP,station_2_IP,...  
station_n_IP exit ↵
```

where

station_1_IP,station_2_IP,...station_n_IP are the IP addresses of the remaining stations in the cluster

9. Enter the following:

```
<main> apply ↵
```

The configuration is applied.

10. Enter the following:

```
<main> exit ↵
```

The samconfig utility closes.

11. Enter the following to switch back to the nsp user:

```
# exit ↵
```

Reconfigure auxiliary database cluster

13 _____
Log in as the root user on one of the remaining auxiliary database stations in the cluster.

14 _____
Open the `/opt/nsp/nfmp/auxdb/install/config/install.config` file using a plain-text editor such as vi.

15 _____

 **CAUTION**
Service disruption

Changing a parameter in the auxiliary database `install.config` file can have serious consequences that include service disruption.

Do not change any parameter in the `install.config` file, other than the parameters described in the steps, without guidance from technical support.

Locate the following line and delete the IP address of the station that is being removed:
`hosts=internal_IP1,internal_IP2...internal_IPn`

16 _____
Locate the following line and delete the IP address entries of the station that is being removed:
`export_hosts=internal_IP1[export_IP1],internal_IP2[export_IP2]...internal_IPn[export_IPn]`

17 _____
Save and close the `install.config` file.

18 _____
Enter the following:
`# /opt/nsp/nfmp/auxdb/install/bin/auxdbAdmin.sh distributeConfig ↵`
The updated configuration is distributed to the other auxiliary database stations in the cluster.

19 _____
Enter the following to allow external access to the auxiliary database ports:
`# /opt/nsp/nfmp/auxdb/install/bin/auxdbAdmin.sh shieldsDown ↵`

20 _____
Enter the following on each remaining auxiliary database station in the cluster to start the database proxy:
`# systemctl start nspos-auxdbproxy.service ↵`

21

If the auxiliary database is standalone, go to [Step 29](#).

Configure standby cluster

22

Log in as the root user on the station that is to be removed from the standby auxiliary database cluster.



Note: The station that you remove from the standby cluster must be the station that occupies the same list position in the NFM-P main server configuration. For example, if the stations in the primary cluster are listed in the order 1, 2, 3, and you are removing station 2, you must remove the second station listed in the configuration of the standby cluster.

23

Enter the following:

```
# /opt/nsp/nfmp/auxdb/install/bin/auxdbAdmin.sh removeNode internal_IP ↵
```

where *internal_IP* is the IP address that the station uses to communicate with the other auxiliary database stations in the cluster

You are prompted for the database user password.

24

Enter the password.

The operation begins.



Note: If a cluster rebalance is required, the operation may take considerable time, depending on the volume of data in the auxiliary database.
The station is removed from the auxiliary database.

25

Log in as the root user on one of the remaining auxiliary database stations in the standby cluster.

26

Enter the following:

```
# cd /opt/nsp/nfmp/auxdb/install/bin ↵
```

27

Perform [Step 14](#) to [Step 20](#).

28

If the NSP deployment does not include the NFM-P, go to [Step 30](#).

Reconfigure NFM-P, geo-redundant auxiliary database

29

Perform the following steps on each main server in each data center.

i **Note:** In a redundant NFM-P deployment, you must perform the steps on the standby main server first.

1. Log in to the main server station as the nsp user.
2. Open a console window.
3. Enter the following:

```
bash$ cd /opt/nsp/nfmp/server/nms/bin ↵
```

4. Enter the following:

```
bash$ ./nmserver.bash stop ↵
```

5. Enter the following:

```
bash$ ./nmserver.bash appserver_status ↵
```

The server status is displayed; the server is fully stopped if the status is the following:

```
Application Server is stopped
```

If the server is not fully stopped, wait five minutes and then repeat this step. Do not perform the next step until the server is fully stopped.

6. Enter the following to switch to the root user:

```
bash$ su - ↵
```

7. Enter the following:

```
# samconfig -m main ↵
```

8. Enter the following:

Note: The order of the IP addresses must be the same on each main server in the geo-redundant system.

```
<main> configure auxdb ip-list IP_list exit ↵
```

where

IP_list is a list of the IP addresses in the following format:

```
cluster_1_IP1,cluster_1_IP2,cluster_1_IPn;cluster_2_IP1,cluster_2_IP2,cluster_2_IPn
```

9. Enter the following:

```
<main> apply ↵
```

The configuration is applied.

10. Enter the following:

```
<main> exit ↵
```

The samconfig utility closes.

11. Enter the following to switch back to the nsp user:

```
# exit ↵
```

Configure NSP clusters

30

Perform [Step 32](#) to [Step 38](#) on the NSP cluster in each data center.

31

Go to [Step 39](#).

32

Log in as the root user on the NSP deployer VM.

33

Open the following file using a plain-text editor such as vi:

```
/opt/nsp/NSP-CN-DEP-release-ID/NSP-CN-release-ID/config/nsp-config.yml
```

34

Locate the following section:

```
auxDb:
  ipList: "cluster_1_IP1,cluster_1_IP2...cluster_1_IPn"
  standbyIpList: "cluster_2_IP1,cluster_2_IP2...cluster_2_IPn"
```

35

Delete the IP address of each auxiliary database station that you are removing.

36

Save and close the file.

37

Enter the following to start the NSP cluster:

i **Note:** If the NSP cluster VMs do not have the required SSH key, you must include the `--ask-pass` argument in the command, as shown in the following example, and are subsequently prompted for the root password of each cluster member:

```
nspdeployerctl --ask-pass install --config --deploy
```

```
# /opt/nsp/NSP-CN-DEP-release-ID/bin/nspdeployerctl install --config --deploy ↵
```

The NSP cluster starts, and the configuration update is put into effect.

38

Close the console window.

Start NFM-P main servers

39

If the NSP deployment includes the NFM-P, start each main server.

i **Note:** In a DR deployment, you must start the primary main server first.

1. Log in to the station as the nsp user.
2. Open a console window.
3. Enter the following:

```
bash$ cd /opt/nsp/nfmp/server/nms/bin ↵
```

4. Enter the following:

```
bash$ ./nmserver.bash start ↵
```

The main server starts.

40

Close the open console windows.

END OF STEPS

20.17 How do I recreate an auxiliary database?

20.17.1 Purpose

If an NSP auxiliary database is not functioning and cannot return to operational status, you may need to recreate the database. Depending on the severity of the failure, however, Nokia support may be able to repair the database.

Perform this procedure only if all attempts to repair the auxiliary database fail, and Nokia support directs you to recreate the database.

20.17.2 Steps

1

If possible, back up the auxiliary database to preserve it for potential data recovery. If data recovery is not required, you can skip this step.

i **Note:** The auxiliary database must be running in order for a backup to be successful. If the auxiliary database cannot be started, you cannot create a database backup.

2

In order to back up an auxiliary database, all members of the local auxiliary database cluster must be operational and available, or the backup fails. Perform [20.4 “How do I check the auxiliary database status?” \(p. 455\)](#) to verify that each local cluster member is operational.

3

Perform the following steps on each auxiliary database station to collect the auxiliary database log files.

i **Note:** You cannot specify /tmp, or any directory below /tmp, as the output directory.

1. Log in to the station as the root user.
2. Enter the following:

```
# /opt/nsp/nfmp/auxdb/install/bin/getDebugFiles.bash output_dir  
days ↵
```

where

output_dir is a local directory that is to contain the output files

days is the optional number of days for which to collect log files; if not specified, all logs are collected

4

On one auxiliary database station, open the /opt/nsp/nfmp/auxdb/install/config/install.config file using a plain-text editor such as vi.

5

Ensure that the internal and external IP addresses in the following lines are correctly assigned to the auxiliary database stations:

```
hosts=internal_IP1,internal_IP2...internal_IPn  
export_hosts=internal_IP1[export_IP1],internal_IP2[export_IP2]...  
internal_IPn[export_IPn]
```

6

If you intend to reuse existing auxiliary database stations, uninstall the auxiliary database as described in the *NSP Installation and Upgrade Guide*.

7

Install the auxiliary database as described in the *NSP Installation and Upgrade Guide*.

i **Note:** If you are performing this procedure to recover from a failed upgrade, you must use the new auxiliary database installation files, and not the installation files from before the upgrade.

8

If the NSP deployment does not include the NFM-P, go to [Step 14](#).

9

When the auxiliary database is fully initialized, perform the following steps on each NFM-P main server station to start the main server, if the server is not started.

i **Note:** In a redundant system, you must start the primary main server first.

1. Log in as the root user on the main server station.
2. Open a console window.
3. Enter the following:

```
bash$ ./nmserver.bash start ↵
```

4. Enter the following:

```
bash$ ./nmserver.bash appserver_status ↵
```

The server status is displayed; the server is fully initialized if the status is the following:

```
Application Server process is running. See nms_status for more detail.
```

If the server is not fully initialized, wait five minutes and then repeat this step. Do not perform the next step until the server is fully initialized.

The main server detects the auxiliary database reinstallation, raises a Critical alarm against the auxiliary database, and begins recreating the auxiliary database schema.

i **Note:** If the main server fails to recreate the schema, the server retries periodically until all schema elements are created.

When the schema recreation is complete, the reinstallation alarm clears, and the NFM-P raises a Major alarm that you must clear manually.

10

If the auxiliary database includes custom data tables, perform the following steps to recreate and repopulate the tables.

1. Log on to the standalone or primary main server station as the nsp user.
2. Enter the following:

```
bash$ cd /opt/nsp/nfmp/server/nms/bin ↵
```

3. Create each custom table, as described in [Step 6 of 20.19 “How do I create and manage custom auxiliary database table attributes?” \(p. 507\)](#), using the saved XML file that defines the table.
4. Add the required data to each table, as described in [Step 7 of 20.19 “How do I create and manage custom auxiliary database table attributes?” \(p. 507\)](#), using the saved CSV file for the table.

11

If you use the Analytics dynamic inventory reporting function, you must recreate the custom inventory tables and dynamic Analytics managed-object definitions.

1. Remove the existing dynamic Analytics managed-object definitions; enter the following on the main server station:

```
bash$ ./nmserver.bash dynamic_analyticmo remove class mo_name ↵  
where
```

class is the object class

mo_name is the name of the dynamic Analytics managed object

2. Create the custom inventory tables; enter the following:

```
bash$ ./customData.bash --createTables XML_file ↵
```

where *XML_file* is the saved XML file that defines the custom inventory tables

3. Create the dynamic Analytics managed-object definitions; enter the following:

```
bash$ ./nmserver.bash dynamic_analyticmo create dyn_inv_XML_file ↵
```

where *dyn_inv_XML_file* is the absolute path and name of the saved XML file that defines the Analytics dynamic inventory configuration

12

If you have created dynamic aggregations, recreate the aggregations.



Note: Any previous aggregation data is lost during the auxiliary database schema recreation earlier in the procedure.

1. Enter the following on the main server station for each dynamic aggregation to remove the aggregation:

```
bash$ ./nmserver.bash dynamic_aggregation remove aggregation ↵
```

where *aggregation* is the name of the aggregation

2. Enter the following to create the dynamic aggregation:

```
bash$ ./nmserver.bash dynamic_aggregation create agg_XML_file ↵
```

where *agg_XML_file* is the absolute path and name of the saved XML file that defines the aggregation configuration

3. Re-enable the dynamic aggregations using an NFM-P XML API or GUI client.

13

If you use periodic accounting tables, enter the following on the main server station to create the tables:



Note: Any previous periodic accounting data is lost during the auxiliary database schema recreation earlier in the procedure.

```
bash$ ./nmserver.bash accountingPeriodic create per_acc_XML_file ↵
```

where *per_acc_XML_file* is the absolute path and name of the saved XML file that defines the periodic accounting configuration

14

Close the open console windows.

END OF STEPS

20.18 How do I customize auxiliary database tables?

20.18.1 Custom auxiliary database table attributes

Some NSP Analytics reports require data that is not available by default. Data such as location names, geographic co-ordinates, and maintenance windows must be imported to an auxiliary database in order to be included in reports. The NFM-P has a mechanism for the creation and management of auxiliary database tables and content.

An XML file that you create defines the table columns and data types to add to an auxiliary database. After you import a table definition to the NFM-P, an operator can add data records to the table using a CSV file whose record format matches the format defined in the XML file. An operator can also delete one or more tables, or the content of a table.

i **Note:** A data-import operation appends the new records to the table, and does not affect the existing table contents or structure.

Custom auxiliary database table attributes are retained through system upgrades, and are included in auxiliary database backup and restore operations.

Table definition file format

[Figure 20-1, “Custom table definition file format” \(p. 504\)](#), shows a table definition XML file that contains the column definitions for two custom tables.

Figure 20-1 Custom table definition file format

```
<customTablesConfig organization="OurCompany" name="CustomTableDefs"
  xmlns:xsi="http://www.w3.org/2001/XMLSchema-instance"
  xsi:noNamespaceSchemaLocation="./schema/customtables.xsd">
  <customTables>
    <customTable
      name="table1"
      description="This is table 1"
      orderBy="column1">
      <columns>
        <column name="column1" type="STRING" length="8" encoding="RLE" />
        <column name="column2" type="INTEGER" />
        <column name="column3" type="FLOAT" />
        <column name="column4" type="BOOLEAN" />
        <column name="column5" type="NUMERIC" precision="12" scale="4" />
      </columns>
    </customTable>
    <customTable
      name="table2"
      description="This is table 2"
      segmentedBy="column1,column2">
      <columns>
        <column name="column1" type="STRING" length="64" />
        <column name="column2" type="STRING" length="64" />
      </columns>
    </customTable>
  </customTables>
</customTablesConfig>
```

```
</customTable>  
</customTables>  
</customTablesConfig>
```

Table 20-1, “Custom attribute definition elements” (p. 505) lists and describes the configurable elements in a custom table definition.

Table 20-1 Custom attribute definition elements

Element	Description
description	Text that describes the table; optional
orderBy	Comma-separated list of column names that define how the table data is to be ordered; optional
segmentedBy	Comma-separated list of column names that define how the table is to be segmented; optional
column name	Table column name
type	One of the following: <ul style="list-style-type: none">• STRING—1 to 4096 characters• INTEGER• FLOAT• BOOLEAN• NUMERIC
precision	Maximum number of significant digits, represented by a positive integer less than or equal to 1024; required for NUMERIC data type
scale	Maximum number of digits to the right of the decimal point in a NUMERIC data type, represented by a positive integer less than or equal to the precision value; if omitted, defaults to 0 If the number of decimal digits in a data value exceeds the scale value, the data value is rounded to the number of digits specified by the scale value.
encoding	Text encoding type for STRING data type; optional, default is AUTO
length	Field length; required for STRING data type

Functional description

The management tool for custom tables is the customData.bash CLI script on a main server station. You can use the tool to do the following:

- create and delete tables
- import, export, and delete data
- list the currently defined custom tables
- export a table schema

i **Note:** In order for the customData.bash script to function, the main server configuration must include an auxiliary database.

i **Note:** If a string data value to be imported includes a comma, you must precede the comma with a backslash to prevent the comma from being interpreted as a CSV file delimiter.

The customData.bash script has the following operating characteristics:

- The script automatically assigns a prefix and suffix to the name of a custom table. References to the table in script operations after table creation must include the samdb prefix and _ct suffix; for example, customTable1 must be specified as samdb.customTable1_ct.
- Script operations that modify data, such as createTable, deleteTable, and importData, require the auxiliary database user password.
- During a createTable operation, a formatting error in an table definition causes all table creation during the operation to fail, and the script saves the table definition file as tmp/customtables.xml.template.
- The script logs each operation in the /opt/nsp/nfmp/server/nms/log/customdata.log; the maximum log size is five Mbytes.

20.19 How do I create and manage custom auxiliary database table attributes?

i **Note:** The *password* value that you specify in the following steps is the password of the samauxdb user.

20.19.1 Steps

- 1 _____
If you are creating a custom table, configure the elements in a table definition XML file using the format described in [“Table definition file format”](#) (p. 505), and store the file securely in a remote location.
- 2 _____
If you are adding data to a custom table, create a CSV-formatted data file that has the same record format as the custom table, and store the file securely in a remote location.
- 3 _____
Log in to the standalone or primary main server station as the nsp user.
- 4 _____
Open a console window.
- 5 _____
Navigate to the /opt/nsp/nfmp/server/nms/bin directory.
- 6 _____

To create a custom table, enter the following:

```
bash$ ./customData.bash -password password -createTables definition_
file ↵
```

where *definition_file* is the table definition XML file created in [Step 1](#)

The specified tables are created.

7

To import data to a custom table, enter the following:

```
bash$ ./customData.bash -password password -importData table_name
data_file ↵
```

where

data_file is the CSV data file created in [Step 2](#)

table_name is the table to which the data is to be imported

The data is imported.

8

To list all custom tables, enter the following:

```
bash$ ./customData.bash -listTables ↵
```

The tables are listed.

9

To delete all data in a custom table, enter the following:

```
bash$ ./customData.bash -password password -deleteData samdb.table_ct
↵
```

where *table* is the name of the table from which to delete data

The table data is deleted.

10

To delete a custom table, enter the following:

```
bash$ ./customData.bash -password password -deleteTable samdb.table_ct
↵
```

where *table* is the name of the table to delete

The table is deleted.

11

To export the data in a custom table to a file, enter the following:

```
bash$ ./customData.bash -exportData samdb.table_ct output_file ↵
```

where

table is the name of the table from which to export data

output_file is the name of the file that is to contain the exported data

The table data are exported to the file.

12 _____

To export a custom table schema to a file, enter the following:

```
bash$ ./customData.bash -tableSchema samdb.table_ct output_file ↵
```

where

table is the name of the table from which to export the schema

output_file is the name of the file that is to contain the exported schema

The table schema is saved in the file.

13 _____

Close the console window.

END OF STEPS _____

21 Classic management administration

NFM-P component administration

21.1 Workflow: redundant NFM-P shutdown and restart

21.1.1 Description

The following is the sequence of high-level actions required to stop and start the redundant NFM-P system components in a graceful manner for maintenance purposes.

21.1.2 Stages

Align redundancy roles

1

If the primary main server and database are in separate data centers, perform [17.13 “How do I perform a main database switchover using the NFM-P client GUI?”](#) (p. 406) to align the primary components in the primary data center.

Perform orderly shutdown of standby components

2

If the system includes NSP Flow Collectors:

1. Stop each Flow Collector in the standby data center, as described in [19.8 “How do I start or stop an NSP Flow Collector?”](#) (p. 440).
2. Stop each Flow Collector Controller in the standby data center, as described in [19.3 “How do I start or stop an NSP Flow Collector Controller?”](#) (p. 436).

3

If the system includes an auxiliary database, stop the auxiliary database cluster in the standby data center, as described in [20.3 “How do I stop an auxiliary database cluster?”](#) (p. 453).

4

If the system includes one or more auxiliary servers, perform the following steps; see [21.7 “How do I stop an auxiliary server?”](#) (p. 519) for information.

1. Stop each Reserved auxiliary server of the standby main server.
2. Stop each Preferred auxiliary server of the standby main server.

5

Stop the standby main server, as described in [21.3 “How do I stop a main server?”](#) (p. 516).

6

Stop the standby main database.

1. Log in to the main database station as the root user.
2. Open a console window.
3. Enter the following to stop the Oracle proxy:

```
# systemctl stop nfmp-oracle-proxy.service ↵
```
4. Enter the following to stop the main database:

```
# systemctl stop nfmp-main-db.service ↵
```

Perform maintenance on standby components

7

Perform the required maintenance on the NFM-P components in the standby data center.

Perform orderly startup of standby components

8

Start the standby main database.

1. Log in to the main database station as the root user.
2. Open a console window.
3. Enter the following to start the Oracle proxy:

```
# systemctl start nfmp-oracle-proxy.service ↵
```
4. Enter the following to start the main database:

```
# systemctl start nfmp-main-db.service ↵
```

9

Start the standby main server, as described in [21.2 “How do I start a main server?”](#) (p. 515).

10

If the system includes one or more auxiliary servers, perform the following steps; see [21.6 “How do I start an auxiliary server?”](#) (p. 518) for information.

1. Start each Reserved auxiliary server of the standby main server.
2. Start each Preferred auxiliary server of the standby main server.

11

If the system includes one or more auxiliary servers, perform the following steps; see [21.6 “How do I start an auxiliary server?”](#) (p. 518) for information.

1. Start each Preferred NFM-P auxiliary server of the standby main server.
2. Start each Reserved NFM-P auxiliary server of the standby main server.

12

If the system includes an auxiliary database, start the auxiliary database cluster in the standby data center, as described in [20.2 “How do I start an auxiliary database cluster?”](#) (p. 453).

13

If the NSP deployment includes NSP Flow Collectors:

1. Start each Flow Collector Controller in the standby data center, as described in [19.3 “How do I start or stop an NSP Flow Collector Controller?”](#) (p. 436).
2. Start each Flow Collector in the standby data center, as described in [19.8 “How do I start or stop an NSP Flow Collector?”](#) (p. 440).

Switch redundancy roles

14

Perform a server activity switch to change the standby main server role to primary, as described in [17.11 “How do I perform a server activity switch?”](#) (p. 404).

The standby main server assumes the primary role.

15

If automatic database realignment is not enabled, perform a database switchover; perform [17.13 “How do I perform a main database switchover using the NFM-P client GUI?”](#) (p. 406) or [17.14 “How do I perform a main database switchover using a CLI script?”](#) (p. 407).

The standby main database assumes the primary role.

Perform orderly shutdown of former primary components

16

If the system includes NSP Flow Collectors:

1. Stop each Flow Collector in the former primary data center, as described in [19.8 “How do I start or stop an NSP Flow Collector?”](#) (p. 440).
2. Stop each Flow Collector Controller in the former primary data center, as described in [19.3 “How do I start or stop an NSP Flow Collector Controller?”](#) (p. 436).

17

If the system includes an auxiliary database, stop the auxiliary database cluster in the former primary data center, as described in [20.3 “How do I stop an auxiliary database cluster?”](#) (p. 453).

18

If the system includes one or more auxiliary servers, perform the following steps; see [21.7 “How do I stop an auxiliary server?”](#) (p. 519) for information.

1. Stop each Reserved auxiliary server of the former primary main server.
2. Stop each Preferred auxiliary server of the former primary main server.

19

Stop the former primary main server, as described in [21.3 “How do I stop a main server?”](#) (p. 516).

20

Stop the former primary main database.

1. Log in to the main database station as the root user.
2. Open a console window.
3. Enter the following to stop the Oracle proxy:

```
# systemctl stop nfmp-oracle-proxy.service ↵
```

4. Enter the following to stop the main database:

```
# systemctl stop nfmp-main-db.service ↵
```

Perform maintenance on former primary components

21

Perform the required maintenance on the NFM-P components in the former primary data center.

Perform orderly startup of former primary components

22

Start the former primary main database.

1. Log in to the main database station as the root user.
2. Open a console window.
3. Enter the following to start the Oracle proxy:

```
# systemctl start nfmp-oracle-proxy.service ↵
```

4. Enter the following to start the main database:

```
# systemctl start nfmp-main-db.service ↵
```

23

Start the former primary main server, as described in [21.2 “How do I start a main server?”](#) (p. 515).

24

If the system includes one or more auxiliary servers, perform the following steps; see [21.6 “How do I start an auxiliary server?”](#) (p. 518) for information.

1. Start each Reserved auxiliary server of the former primary main server.
2. Start each Preferred auxiliary server of the former primary main server.

25

If the system includes one or more auxiliary servers, perform the following steps; see [21.6 “How do I start an auxiliary server?”](#) (p. 518) for information.

1. Start each Preferred NFM-P auxiliary server of the former primary main server.
2. Start each Reserved NFM-P auxiliary server of the former primary main server.

26

If the system includes an auxiliary database, start the auxiliary database cluster in the former primary data center, as described in [20.2 “How do I start an auxiliary database cluster?”](#) (p. 453).

27

If the NSP deployment includes NSP Flow Collectors:

1. Start each Flow Collector Controller in the former primary data center, as described in [19.3 “How do I start or stop an NSP Flow Collector Controller?”](#) (p. 436).
2. Start each Flow Collector in the former primary data center, as described in [19.8 “How do I start or stop an NSP Flow Collector?”](#) (p. 440).

Restore initial redundancy roles

28

If required, restore the initial redundancy roles so that the former primary main server and database again assume the primary roles.

1. Perform a server activity switch to restore the initial primary and standby main server roles, as described in [17.11 “How do I perform a server activity switch?”](#) (p. 404).

The former primary and standby main server roles are restored.

29

If automatic database realignment is not enabled, perform a database switchover; perform [17.13 “How do I perform a main database switchover using the NFM-P client GUI?”](#) (p. 406) or [17.14 “How do I perform a main database switchover using a CLI script?”](#) (p. 407).

The former primary and standby main database roles are restored.

21.2 How do I start a main server?

21.2.1 Steps

1

Log in to the main server station as the nsp user.

2

Open a console window.

3

Enter the following:

```
bash$ /opt/nsp/nfmp/server/nms/bin/nmsserver.bash start ↵
```

The main server starts.

4

Close the console window.

END OF STEPS

21.3 How do I stop a main server?



CAUTION

Service Disruption

Performing this procedure may be service-affecting.

Ensure that you perform this procedure only during a scheduled maintenance period.

21.3.1 Steps

1

Log in to the main server station as the nsp user.

2

Open a console window.

3

Enter the following:

```
bash$ cd /opt/nsp/nfmp/server/nms/bin ↵
```

4

Enter the following:

```
bash$ ./nmsserver.bash stop ↵
```

5

Enter the following:

```
bash$ ./nmsserver.bash appserver_status ↵
```

The server status is displayed; the server is fully stopped if the status is the following:

Application Server is stopped

If the server is not fully stopped, wait five minutes and then repeat this step. Do not perform the next step until the server is fully stopped.

6

Enter the following to switch to the root user:

```
bash$ su - ↵
```

END OF STEPS

21.4 How do I start a main database?



CAUTION

Service Disruption

Performing this procedure may be service-affecting.

Ensure that you perform this procedure only during a scheduled maintenance period.

21.4.1 Steps

1

Log in to the main database station as the root user.

2

Open a console window.

3

Enter the following to start the Oracle proxy:

```
# systemctl start nfmp-oracle-proxy.service ↵
```

4

Enter the following to start the main database:

```
# systemctl start nfmp-main-db.service ↵
```

5

Close the console window.

END OF STEPS

21.5 How do I stop a main database?



CAUTION

Service Disruption

Performing this procedure may be service-affecting.

Ensure that you perform this procedure only during a scheduled maintenance period.

21.5.1 Steps

- 1 _____
Log in to the main database station as the root user.
- 2 _____
Open a console window.
- 3 _____
Enter the following to stop the Oracle proxy:
`# systemctl stop nfmp-oracle-proxy.service ↵`
- 4 _____
Enter the following to stop the main database:
`# systemctl stop nfmp-main-db.service ↵`
- 5 _____
Close the console window.

END OF STEPS _____

21.6 How do I start an auxiliary server?

21.6.1 Steps

- 1 _____
Choose Administration→System Information from the NFM-P main menu. The System Information form opens.
- 2 _____
Click on the Auxiliary Servers tab.
- 3 _____
Select the auxiliary server and click Properties. The Auxiliary Server (Edit) form opens.

-
- 4 _____
Set the Operation Mode parameter to In Service.
 - 5 _____
Click OK to commit the change and close the form.
 - 6 _____
Close the System Information form.
 - 7 _____
Log in to the auxiliary server station as the nsp user.
 - 8 _____
Open a console window.
 - 9 _____
Enter the following:

```
bash$ /opt/nsp/nfmp/auxserver/nms/bin/auxnmserver.bash auxstart ↵
```

The auxiliary server starts.
 - 10 _____
Close the console window.
- END OF STEPS _____

21.7 How do I stop an auxiliary server?



CAUTION

Service Disruption

Performing this procedure may be service-affecting.

Ensure that you perform this procedure only during a scheduled maintenance period.

21.7.1 Steps

- 1 _____
Choose Administration→System Information from the NFM-P main menu. The System Information form opens.
- 2 _____
Click on the Auxiliary Servers tab.

-
- 3 _____
Select the auxiliary server and click Properties. The Auxiliary Server (Edit) form opens.
 - 4 _____
Set the Operation Mode parameter to In Maintenance Mode.
 - 5 _____
Click OK to commit the change and close the form.
The auxiliary server stops.
 - 6 _____
Close the System Information form.

END OF STEPS _____

NFM-P administration and management

21.8 What is global NFM-P system configuration?

21.8.1 Introduction

The NFM-P may require a configuration change to meet specific operational requirements. You can use the procedures in this section to configure global NFM-P settings, functions, and preferences.

Graceful NFM-P system shutdown and startup



CAUTION

Service Outage

Stopping the NFM-P software on a station, or rebooting a station that hosts NFM-P software, may have serious consequences that can include a complete network management outage.

You must perform such service-affecting actions only as directed by the NSP documentation or technical support, and only during a scheduled maintenance period.

Low-level maintenance that is not described in this section, for example, applying a RHEL OS patch to the NFM-P component stations, may require that you stop and start each station.

Stopping a standalone NFM-P system creates a network management outage that must be considered in the planning for a maintenance activity that requires such action.

In a redundant NFM-P system, you can avoid such an outage by performing the orderly shutdown and startup of the components described in [21.1 “Workflow: redundant NFM-P shutdown and restart”](#) (p. 511).

Global GUI-client updates

The NFM-P auto-client update function allows you to reconfigure multiple GUI clients using one central configuration. See the *NSP Installation and Upgrade Guide* for client update configuration information, and [21.14 “How do I modify the base configuration of all GUI clients?”](#) (p. 535) for information about using the auto-update function to push an update to all GUI clients.

21.9 How do I change default text-field and ID ranges?

21.9.1 Format and range policies overview

You can use NFM-P format policies and range policies to change the default number and format of characters used for text fields, and the ID ranges used for managed objects.

21.9.2 Format and range policies

Format policies manage how services, policies, LSPs, and L2 and L3 access interfaces are named and described. Range policies manage the ID values that are assigned to services, policies, LSPs, and L2 and L3 access interfaces. For example, you can configure the following:

- a range policy that specifies a range of 200 to 499 for service IDs

- a format policy that specifies a 15-character limit for service names

The object creation form indicates when a range or format policy is in effect for an object.

Format and range policies are not distributed to NEs. The format and range policies apply only to GUI creation of services, policies, LSPs, and L2 and L3 access interfaces. You cannot configure format and range policies when the services, LSPs, and L2 and L3 access interfaces are created using templates. However, the NFM-P allows an operator to use preconfigured examples of LSPs and services that have format and range policies applied to them. You can use the examples to create templates.

See [21.12 “How do I create or configure a format policy?” \(p. 532\)](#) for information about configuring a format policy.

See [21.13 “How do I create or configure a range policy?” \(p. 533\)](#) for information about configuring a range policy.

The following table lists the objects and associated parameters that can be managed using format and range policies.

Table 21-1 Format and Range policy objects and associated parameters

Object name	Format policy parameter	Range policy parameter
B-VPLS Service Site	Description, Name	—
Bypass-only LSP	Description, Name	ID
Customer	—	ID
Dynamic LSP	Description, Name	ID
I-VPLS Service Site	Description, Name	—
IES Group Interface	Description, Name	Interface ID
IES L3 Access Interface	Description, Name	Interface ID, Outer Encapsulation Value
IES Service	Description, Service Name	Service ID
IES Service Access Point	Description, Name	Outer Encapsulation Value
IES Service Site	Description, Name	—
IES Subscriber Interface	Description, Name	Interface ID
IP Mirror Interface	—	Interface ID
MVPLS B-L2 Access Interface	Description	Outer Encapsulation Value
MVPLS I-L2 Access Interface	Description	Outer Encapsulation Value
MVPLS L2 Access Interface	Description	Outer Encapsulation Value
MVPLS Service	Description, Service Name	Service ID
Mirror L2 Access Interface	—	Outer Encapsulation Value
MVPLS Service B-Site	Description, Name	—
MVPLS Service I-Site	Description, Name	—

Table 21-1 Format and Range policy objects and associated parameters (continued)

Object name	Format policy parameter	Range policy parameter
MVPLS Service Site	Description, Name	—
Mirror Service	Description, Service Name	Service ID
Mirror Service Site	Description, Name	—
Redundant Interface	—	Interface ID
Spoke SDP Binding	—	VC ID
Static LSP	Description, Name	ID
Tunnel	Description, Name	ID
VLAN L2 Access Interface	Description	—
VLAN Service	Description, Service Name	Service ID
VLAN Service Access Point	Description, Name	—
VLAN Service Site	Description, Name	—
VLL Apipe Service	Description, Service Name	Service ID
VLL Apipe Service Site	Description, Name	—
VLL Cpipe Service	Description, Service Name	Service ID
VLL Cpipe Site	Description, Name	—
VLL Epipe Service	Description, Service Name	Service ID
VLL Epipe Service Site	Description, Name	—
VLL Fpipe Service	Description, Service Name	Service ID
VLL Fpipe Service Site	Description, Name	—
VLL Ipipe L2 Access Interface	Description	Outer Encapsulation Value
VLL Ipipe Service	Description	Service ID
VLL Ipipe Site	Description, Name	—
VLL L2 Access Interface	Description	Outer Encapsulation Value
VPLS B-L2 Access Interface	Description	Outer Encapsulation Value
VPLS I-L2 Access Interface	Description	Outer Encapsulation Value
VPLS L2 Access Interface	Description	Outer Encapsulation Value
VPLS L2 Management Interface	—	Interface ID
VPLS Service	Description, Service Name	Service ID
VPLS Service Site	Description, Name	—
VPRN Group Interface	Description, Name	Interface ID
VPRN L3 Access Interface	Description, Name	Interface ID, Outer Encapsulation Value

Table 21-1 Format and Range policy objects and associated parameters (continued)

Object name	Format policy parameter	Range policy parameter
VPRN Service	Description, Service Name	Service ID
VPRN Service Access Point	Description, Name	Outer Encapsulation Value
VPRN Service Site	Description, Name	—
VPRN Subscriber Interface	Description, Name	Interface ID

The following table lists the policies that support format and range policies.

Table 21-2 Format and Range policy objects and associated parameters for policies

Policy	Format policy	Range policy
Access Ingress QoS	Description, Displayed Name	ID
Access Egress QoS	Description, Displayed Name	ID
ATM QoS policy	Description, Displayed Name	ID
Egress Queue Group template	Description, Displayed Name	—
7705 SAR Fabric Profile	Description, Displayed Name	ID
Policer Control policy	Description, Displayed Name	—
HSMDA Pool policy	Description, Displayed Name	—
HSMDA Scheduler policy	Description, Displayed Name	—
HSMDA WRED Slope policy	Description, Displayed Name	—
Ingress Queue Group template	Description, Displayed Name	—
MCFR Egress QoS Profile	Description	Profile ID
MCFR Ingress QoS Profile	Description	Profile ID
MLPPP Egress QoS Profile	Description	Profile ID
MLPPP Ingress QoS Profile	Description	Profile ID
Named Buffer Pool policy	Description, Name	—
Network policy	Description, Displayed Name	ID
Network Queue	Description, Name	—
Port Scheduler policy	Description, Displayed Name	—
Sap Access Ingress for 7210	Description, Displayed Name	ID
Network Policy for 7210	Description, Displayed Name	NW Mgr ID, Policy Id
Network Queue for 7210	Description, Name	—
Port Access Egress for 7210	Description, Displayed Name	ID
Port Scheduler for 7210	Description, Displayed Name	—
Slope Policy for 7210	Description, Displayed Name	—

Table 21-2 Format and Range policy objects and associated parameters for policies (continued)

Policy	Format policy	Range policy
Scheduler policy	Description, Displayed Name	—
WRED Slope policy	Description, Displayed Name	—
ACL IP filter	Description, Displayed Name	Filter ID
ACL IPv6 filter	Description, Displayed Name	Filter ID
ACL MAC filter	Description, Displayed Name	Filter ID
ANCP policy	Displayed Name	—
Host Tracking policy	Description, Displayed Name	—
MSAP policy	Description, Displayed Name	—
PPPoE policy	Description, Displayed Name	—
SLA Profile	Description, Displayed Name	—
Subscriber Explicit Map Entry	Description, Displayed Name	—
Subscriber Identification policy	Description, Displayed Name	—
Subscriber Profile	Description, Displayed Name	—
AA Application filter	—	Entry ID
Egress Multicast Group	Description, Displayed Name	—
Multicast Package	Description, Displayed Name	ID
Multicast CAC	Description, Name	—
Multicast PathMgmt BW policy	Description, Name	—
Multicast PathMgmt Info policy	Description, Name	—
AS Path	Description, AS Path Name	—
Community	Description, Community Name	—
Community Member	Community Member	—
Damping	Damping Name	—
Prefix List	Description, Prefix List Name	—
Statement	Description, Statement Name	—
Service L3 Routing	Export Target IP Address, Import Target IP Address, Target IP Address	Export Target AS Value, Export Target AS Value (4Byte), Export Target Community Value, Export Target Extended Community Value, Export Target AS Value, Import Target AS Value (4Byte), Import Target Community Value, Import Target Extended Community Value, Target AS Value, Target AS Value (4Byte), Target Community Value, Target Extended Community Value,

Table 21-2 Format and Range policy objects and associated parameters for policies (continued)

Policy	Format policy	Range policy
MPLS Administrative Groups	Displayed Name	Value
Static Configuration for SRLGs	Displayed Name	—
Shared Risk Link Group Static Config	Displayed Name	Value
Accounting policy	Description, Displayed Name	ID
File policy	Description, Displayed Name	ID
Maintenance Domain	Description, Name	MD Mgr ID
Network Address Translation policy	Description, Displayed Name	—
PAE 802_1x policy	Description, Displayed Name	—
RADIUS Based Accounting	Description, Displayed Name	—
RMON	Description, Displayed Name	—
Time of Day Suite	Description, Name	—
Time Range	Description, Name	—
VRRP policy	Description, Displayed Name	ID, Service ID

21.10 What are the system preferences configuration procedures?

21.10.1 Description

The following procedures describe how to set parameters that globally define NFM-P operation, such as GUI display options, operational thresholds, and aspects of network management.

21.11 How do I set the NFM-P system preferences?



CAUTION

Service Disruption

A system preference setting typically applies globally to an NFM-P system; changing a system preference setting may adversely affect NFM-P operation.

Contact technical support before you attempt to change a System Preferences setting.



Note: Changing a system preference requires a scope of command role with administrator privileges.

21.11.1 Steps

1

Choose Administration→System preferences from the NFM-P main menu. The System Preferences form opens.

The following table lists and describes, by tab, the functions on the System Preferences form, and where to find additional information, if applicable. The table lists the tabs in sequential order of display.

i **Note:** The descriptions in the table are general, and not an exhaustive list of the available settings. Specific System Preferences requirements and settings are described in NFM-P procedures, as required.

Table 21-3 NFM-P system preferences

Tab and available settings	See
General	
GUI form display — tabs shown or hidden by default, whether to allow customization	<i>NSP NFM-P User Guide</i>
CSV encoding for file export operations	
<p>NE display threshold for equipment groups in navigation tree — maximum NEs displayed in expanded equipment group</p> <p>Equipment groups can contain up to 2000 NEs. The GUI navigation tree display a maximum of 500 NEs per group.</p> <p>You can set the NE display threshold for Equipment Group parameter to accomplish any of the following:</p> <ul style="list-style-type: none"> To display all the NEs in equipment groups that contain no more than 500 NEs, set the parameter to 500. To display a small number of NEs per equipment group, set the parameter to a low value. The minimum setting is 2. You can use the NE list form to access and manage the NEs in the group, and you can show additional NEs in the tree if required. See “To manage NEs in equipment groups on the navigation tree” in the <i>NSP NFM-P User Guide</i>. To allow the display of enough NEs to meet your typical requirements while also allowing additional NEs to show in the tree if necessary, set the parameter to a value in the middle of the range. This is useful if you have more than 500 NEs in a group. For example, if the parameter is set to 300, then 300 of the NEs in the group are displayed in the tree. You can select and display up to 200 additional NEs in that group before the limit of 500 is reached. Select the additional NEs to show in the tree from the NE list form for the group; see “To manage NEs in equipment groups on the navigation tree” in the <i>NSP NFM-P User Guide</i>. <p>You must close and re-open the NFM-P client for changes to the NE display threshold for Equipment Group parameter to take effect. The change is propagated to all GUI clients during the next client startup.</p>	
Services	

Table 21-3 NFM-P system preferences (continued)

Tab and available settings	See
<p>Default behavior for the following service functions:</p> <ul style="list-style-type: none"> • Composite services: <ul style="list-style-type: none"> - Allow or suppress the auto discovery of Spoke, CCAG, SCP, or RVPLS connectors. - Enable or disable the use of VRF Route Target connections. - Specify whether service alarms are aggregated in composite services. • Service bandwidth management: <ul style="list-style-type: none"> - Allow or suppress multi-segment tunnel selection. - Enable or disable Service Bandwidth Management (CAC). • Specify the maximum of sites that can be moved from one service to another when reducing the overall size of a particular service; the default is 25. • Specify the default priority of a service when creating a service; the default is set to Low. • Allow or suppress VPRN SNMP Community string warnings and alarms. • Allow or suppress the automatic removal of an empty service. • Enable or disable the use of multi-segment tunnel selection functionality. • Specify if a site name and description are to be added when a service is created. • Allow or suppress Route Target Reservation alarms. • Enable or disable if a service or service site can be deleted if the service or service site has any child objects such as SAPs, SDP bindings, policies, or any other objects related to the service CLI hierarchy. When enabled, you must first delete all child objects before the service or service site can be deleted. This preference only applies to services or service site associated with SROS-based devices. • Specify if a Service Name is to be added to the Site Name when sites are added to a service. 	<p><i>NSP NFM-P User Guide</i></p>
TCA	
<p>Allows you to configure the default behavior associated with configuring TCA policies such as specifying the maximum TCA limit, the TCA reset synchronization time or reset interval, and the default TCA severity.</p>	<p><i>NSP NFM-P User Guide</i></p>
Statistics	
<p>Allows you to configure the default behavior associated when exporting statistics files, such as specifying the log file retention and rollover times.</p>	<p><i>NSP NFM-P Statistics Management Guide</i></p>
<p>Allows you to enable or disable the database storage of statistics; when database storage is disabled for a statistics type, the statistics data is retained only temporarily on a main or auxiliary server, and must be retrieved using the registerLogToFile XML API method</p>	<p><i>NSP NFM-P Statistics Management Guide</i></p>
<p>The Accumulate time over suspect intervals parameter specifies how to manage the Periodic Time of the first valid statistics record after a suspect collection of the record.</p> <p>When the parameter is enabled, the Periodic Time of a record increases by the collection interval length after each consecutive suspect collection. Consequently, the periodic data values in the first valid record are averaged over a greater time span to yield a more realistic value.</p>	<p><i>NSP NFM-P Statistics Management Guide</i></p>
<p>Allows you to configure the number of JMS client connection checks that are performed when exporting statistics files before a registerLogToFile request is automatically de-registered.</p>	<p><i>NSP NFM-P XML API Developer Guide</i></p>

Table 21-3 NFM-P system preferences (continued)

Tab and available settings	See
Allows you to specify whether the accounting policy ID is included in the header of each accounting file. The function enables an OSS to use XML API filters based on the policy ID, if required.	NSP NFM-P Statistics Management Guide NSP NFM-P XML API Developer Guide
Bin Alarm	
Allows you to configure the maximum Bin Alarm limit, reset synchronization time, reset interval, and alarm severity.	NSP NFM-P User Guide
Test Manager	
Allows you to configure the default retention time for dB test results and target test results and log files performed with the Service Test Manager and which test results are stored.	NSP NFM-P User Guide
User Activity	
Allows you to configure how much user activity log information the NFM-P stores before purging information, and how long to retain the information.	9.7 "What is user activity logging?" (p. 172)
OLC	
<p>Allows you to configure the default behavior associated with OLC state of an object that is undergoing commissioning or maintenance. You can configure the following:</p> <ul style="list-style-type: none"> • In the Automatic OLC State Change panel, enable or disable the Enable Automatic OLC State change parameter to indicate whether the OLC state is automatically set to maintenance when the following actions occur: <ul style="list-style-type: none"> - When the Administrative state is down. - If the status of the parent object is set to administratively down. - If the affecting object administrative state is down. <p style="text-align: center;">If the Enable Automatic OLC State change parameter is enabled, a Shut Down action sets the object OLC state to Maintenance and a Turn Up action sets the object OLC state to In Service. This state change is also applied to any child objects, unless the child object OLC state is locked in maintenance mode.</p> • In the OLC Scheduling panel, for scheduled objects that are set to maintenance mode, enable the Create Info Alarm Prior to OLC Revert, if an info alarm is to be raised prior to an OLC revert and the lead time of the alarm notification before reverting. • In the OLC Scheduling panel, you can customize the three revert times that appear for the Revert OLC State parameter in the in the OLC panel on service and network object properties forms. 	21.58 "How do I schedule an OLC state change?" (p. 592)
Policies	

Table 21-3 NFM-P system preferences (continued)

Tab and available settings	See
<p>Allows you to display or hide the policy names on policy configuration forms for the following:</p> <ul style="list-style-type: none"> • Access ingress and access egress policies • ACL IP, ACL IPv6, and ACL MAC policy filters • QoS network policies 	<p><i>NSP NFM-P User Guide</i></p>
<p>Allow you to set a restriction in the distribution mode for certain types of local policies that will permit local editing only. Additionally, the following applies to this system preference configuration:</p> <ul style="list-style-type: none"> • Policy types supported by this system preference include Access Ingress, Access Egress, Network QoS, ACL MAC, ACL IPv4, and ACL IPv6. • When creating any of these policies, if you set the Scope parameter to exclusive, the NFM-P will set the distribution mode to local edit. • The NFM-P will not allow policies with the Scope parameter set to exclusive to be assigned or used more than once. • If you attempt to set the Policy Distribution Mode to Sync With Global while the Scope attribute is configured as exclusive, an error message will result. 	
<p>Allow you to specify that for policy changes made using CLI, to switch the distribution mode for certain types of local policies to Local Edit Only, as opposed to the default Sync with Global mode.</p>	
<p>Allows you to configure the automatic distribution of a global policy to applicable NEs once the policy is released.</p>	
<p>Allows you to configure the maximum number of scheduled audit results stored for a local policy.</p>	
<p>Allows you to enable or disable if all zones are re-synchronized from the node as local edit only. If you disable the Discover Security Zone in Local Edit Only parameter, all zones re-synchronized from the node are set to Sync With Global.</p> <ul style="list-style-type: none"> • The Discover Security Zone in Local Edit Only parameter is only supported on the 7705 SAR-8 with CSMv2, 7705 SAR-8v2 with CSMv2, 7705 SAR-18, 7705 SAR-H, 7705 SAR-Hc, and 7705 SAR-Wx variants, Release 6.1 R1 or later. 	
<p>Custom NE Properties</p>	
<p>Allows you to configure if custom property labels and values are used to identify an NE, for example, the location and site name that differs from the actual NE site name. These properties cannot be configured on the NE. Additionally, the following applies to this system preference configuration:</p> <ul style="list-style-type: none"> • If custom property labels are not configured, the default labels are used. • NE custom properties support the extended character set including multi-byte characters. • Custom property labels and values are displayed in the following locations: <ul style="list-style-type: none"> - NE Properties form - NE List form 	<p>—</p>
<p>ESM</p>	

Table 21-3 NFM-P system preferences (continued)

Tab and available settings	See
Allows you to configure the default behavior associated with the on-demand retrieval of residential subscriber-related information from NEs such as: <ul style="list-style-type: none"> • The tracked subscriber retrieval timeout interval • The subscriber host retrieval timeout interval • The maximum number of residential subscriber instances returned via XML API • If managed route information is to be collected • If QoS override information is to be collected • If SLAAC host addresses are to be collected • If access loop encapsulations are to be collected • If BGP peer information is to be collected 	<i>NSP NFM-P User Guide</i>
Multi Vendor	
Allows you to configure the Enforce SysObjectId Validation on Driver Module parameter. The parameter specifies whether a driver replacement will be blocked if the SysObjectIds do not match.	<i>NSP NFM-P User Guide</i>
MPR	
Allows or denies user-access to configure Wavence devices using a Local Craft Terminal (LCT). This prevents multi-write access sessions on Wavence devices. You can also enable or disable if the NFM-P receives LAC alarms from the nodes.	<i>NSP NFM-P Wavence User Guide</i>
Application Assurance	
Allows you to configure the default behavior for the following NFM-P AA functions: <ul style="list-style-type: none"> • The database persisted transit IP address retrieval time interval • The database persisted transit prefix address retrieval time interval • The maximum number of database transit subscribers returned via XML API 	<i>NSP NFM-P User Guide</i>
Network Group Encryption	
Allows you to set the NGE version	<i>NSP NFM-P User Guide</i>

2 _____
 Configure the required parameters. Information about system preferences parameters is available from the Parameter Search Tool in the [NSP Network Developer Portal](#).

3 _____
 As required, click on the appropriate tab to configure another system preference.

4 _____
 Click OK to save your changes and close the form.

END OF STEPS _____

21.12 How do I create or configure a format policy?

21.12.1 Steps

- 1 _____
Choose Administration→Format and Range Policies from the NFM-P main menu. The Format and Range Policies form opens.
- 2 _____
Expand Format/Range (Property Rules) and choose Format Policy (Property Rules) from the Select Object Type drop-down menu.
- 3 _____
Click Create or choose a format policy and click Properties. The Format Policy (Create | Edit) form opens.
- 4 _____
Configure the required parameters.
- 5 _____
Select an object and property for which you need to apply the name format policy in the Property panel.
- 6 _____
Click on the Users tab.
 **Note:** Only users and user groups that are assigned to this policy are affected by the policy. You can apply one or more format policies to a user or user group.
- 7 _____
Click Add. The Select User form opens with a list of users.
- 8 _____
Select one or more users in the list and click OK. The Format Policy form is refreshed with the selected users.
- 9 _____
Click on the User Groups tab.
- 10 _____
Click Add. The Select Group form opens with a list of user groups.

-
- 11 Choose one or more user groups in the list and click OK. The Format Policy (Create | Edit) form is refreshed with the selected user groups.
- 12 Click on the Text Block Formats tab to further define the format of the text. For example, an operator can classify a group of services with a similar name. The operator can also create a tool tip text to describe the purpose of the parameter.
- 13 Click Move Up or Move Down to change the sequence of the text blocks in the text string.
- 14 Click Create and perform one of the following:
- a. Choose Auto-Filled Parameter. The Auto-Filled Parameter (Create) form opens.
 - b. Choose Masked Text Parameter. The Formatted Text (Create) form opens.
 - c. Choose Number Range Parameter. The Number Range (Create) form opens.
 - d. Choose Text Parameter. The Text (Create) form opens.
- 15 Configure the required parameters.
- The Min. Length and Max. Length parameters are not configurable when the Read Only parameter is enabled.
- 16 Save your changes and close the forms.
-  **Note:** After a format policy is applied to a service, a drop-down menu is displayed beside the object field during object creation, to indicate that a format policy is in effect. When there is only one matching policy, the drop-down menu is dimmed. When there are multiple matching policies, the drop-down menu is used to choose a policy. The sequence of the policies in the drop-down menu is based on the value of the Priority parameter.

END OF STEPS

21.13 How do I create or configure a range policy?

21.13.1 Steps

-
- 1 Choose Administration→Format and Range Policies from the NFM-P main menu. The Format and Range Polices form opens.

2 Expand Format/Range (Property Rules) and choose Range Policy (Property Rules) from the Select Object Type drop-down menu.

3 Click Create or choose a range policy and click Properties. The Range Policy (Create | Edit) form opens.

4 Configure the required parameters.

5 Select an object and property for which you need to apply the range policy in the Property panel.

6 Configure the parameters in the Range panel.

7 Configure the parameters in the Auto Assignment panel.

8 Click on the Users tab.

 **Note:** Only users and user groups that are assigned to this policy are affected by the policy. You can apply one or more range policies to a user or user group.

9 Click Add. The Select User form opens with a list of users.

10 Choose one or more users in the list and click OK. The Range Policy form is refreshed with the users.

11 Click on the User Groups tab.

12 Click Add. The Select Group form opens with a list of user groups.

13 Choose one or more user groups in the list and click OK. The Range Policy form is refreshed with the user groups.

14

Click OK and close the forms.



Note: After a range policy is applied to a service, a drop-down menu is displayed beside the object field during object creation, to indicate that a range policy is in effect. When there is only one matching policy, the drop-down menu is dimmed. When there are multiple matching policies, the drop-down menu is used to choose a policy. The sequence of the policies in the drop-down menu is based on the value of the Priority parameter.

END OF STEPS

21.14 How do I modify the base configuration of all GUI clients?



Note: You can exclude a specific NFM-P client from a global configuration change by using a command line option when you open the client GUI.

21.14.1 Steps

1

Log in to the NFM-P main server station as the nsp user.

2

Modify the appropriate client configuration file in the `/opt/nsp/nfmp/server/nms/config/clientDeploy` directory. For example, update the `nms-client.xml` file with a new client log location.

3

Open a console window.

4

Enter the following to enable an update notification for clients that connect to the server and to prepare the client configuration files for download.

```
bash$ /opt/nsp/nfmp/server/nms/bin/nmsdeploytool.bash deploy ↵
```

5

Close the console window.

6

Perform one of the following on each single-user GUI client and client delegate server station.



Note: When you perform this step on a client delegate server station, you affect each GUI client that connects through the client delegate server.

- a. Update the client configuration by restarting the client GUI. The client automatically backs up the current configuration and applies the configuration change.

How do I change the default user file locations on a client delegate server?

i **Note:** On a RHEL client delegate server station, you must start the client software as the root user, or the configuration update fails.

On RHEL, the client configuration backup is stored in the *path*/nms/configBackup directory, where *path* is the client installation location, typically /opt/nsp/client.

On Windows, the client configuration backup is stored in the *path*\nms\configBackup directory, where *path* is the client installation location, typically C:\nsp\client.

- b. Retain the current client configuration when the client GUI starts by specifying the startup option that disables the auto-client update function. See “Procedures for opening and closing the GUI” in the *NSP NFM-P User Guide* for information about GUI client startup options.

i **Note:** Specifying a client startup option affects only the current GUI session. To ensure that the client configuration is not updated automatically during a subsequent session, you must open the session using the startup option that disables the auto-client update.

END OF STEPS

21.15 How do I change the default user file locations on a client delegate server?

21.15.1 Purpose

Perform the procedure to configure the default location of one or more of the following on an NFM-P client delegate server:

- user preference files that contain the following information:
 - saved table layouts
 - preferences saved using Application→User Preferences
- script result files

21.15.2 Steps

1

Close each GUI client that connects through the client delegate server by choosing Application→Exit from the NFM-P main menu.

2

Log in to the client delegate server station as the nsp user.

3

Open a console window.

4

Navigate to the client configuration directory, typically /opt/nsp/client/nms/config on RHEL, and C:\nsp\client\nms\config on Windows.

5 _____
Open the nms-client.xml file using a plain-text editor.

6 _____
To change the default GUI preferences and table layout file location, insert the following line directly above the </configuration> line at the end of the file:

```
guiPreferences path="new_file_location" />
```

where *new_file_location* is the new default GUI table layout and GUI preferences location

i **Note:** The specified location can be an absolute file path, or a file path relative to *install_dir/nms*, where *install_dir* is the client installation location.

7 _____
To change the default script result file location, insert the following line directly above the </configuration> line at the end of the file:

```
cache directoryName="new_file_location" />
```

where *new_file_location* is the new default script result file location

i **Note:** The specified location can be an absolute file path, or a file path relative to *install_dir/nms*, where *install_dir* is the client installation location.

8 _____
Save and close the nms-client.xml file. Subsequent client GUI sessions on the client delegate server use the new file location.

END OF STEPS _____

21.16 How do I enable main database backup file synchronization?

21.16.1 Purpose

Perform the procedure to enable the main servers in a redundant NFM-P system to synchronize the main database backup file sets. After a database backup, if database backup file synchronization is enabled, the NFM-P automatically copies the database backup file set to the standby database station.

i **Note:** The procedure applies only to a redundant NFM-P system.

i **Note:** Before you perform the procedure, you must ensure that there is sufficient network bandwidth between the main database stations for a database copy operation. See the *NSP NFM-P Planning Guide* for information about the bandwidth requirements of database backup file synchronization.

i **Note:** You must perform the procedure first on the standby main server station, and then on the primary main server station.

21.16.2 Steps

- 1 _____
Log in to the main server station as the root user.
- 2 _____
Open a console window.
- 3 _____
Enter the following:

```
# samconfig -m main ↵
```

The following is displayed:
Start processing command line inputs...
<main>
- 4 _____
Enter the following:

```
<main> configure redundancy database backup-sync ↵
```

The prompt changes to <main configure redundancy database>.
- 5 _____
Enter the following:

```
<main configure redundancy database> exit ↵
```

The prompt changes to <main>.
- 6 _____
Enter the following:

```
<main> apply ↵
```

The configuration change is applied.
- 7 _____
Enter the following:

```
<main> exit ↵
```

The samconfig utility closes.
- 8 _____
Enter the following to switch to the nsp user:

```
# su - nsp ↵
```

9 _____
Navigate to the `/opt/nsp/nfmp/server/nms/bin` directory.

10 _____
Enter the following:

```
bash$ ./nmserver.bash read_config ↵
```

The main server puts the configuration change into effect. The NFM-P automatically copies subsequent main database backup file sets from the primary database station to the standby database station.

11 _____
Close the console window.

END OF STEPS _____

21.17 How do I modify the default time period of statistics displayed by the Statistics Manager search filters?

21.17.1 Purpose

By default, the NFM-P Statistics Manager limits search results to statistics records collected during the past hour. Perform the procedure to modify the default time period of the statistics displayed by the NFM-P Statistics Manager search filters.



CAUTION

Service Disruption

Consider possible service disruptions before modifying the statistics default time period.

Changing the default time period for the NFM-P Statistics Manager search filters can affect the performance of the NFM-P.

21.17.2 Steps

1 _____
Choose Application→Exit to close the NFM-P client GUI, if it is open.

2 _____
Navigate to the client configuration directory, typically `/opt/nsp/client/nms/config` on RHEL, and `C:\nsp\client\nms\config` on Windows.

3 _____
Open the `nms-client.xml` file using a text editor.

How do I modify the default time period of statistics displayed on object properties forms?

- 4 _____
Locate the section that begins with the following XML tag:

```
<statistics
```
- 5 _____
Edit the following line to read:

```
browserDefaultHour="value"
```

where *value* is the default number of hours for the Past <number_of_hours> filter
- 6 _____
Save the changes and close the file.
- 7 _____
Log in to an NFM-P GUI client to verify that the new value is displayed on the Statistics Manager form.

END OF STEPS _____

21.18 How do I modify the default time period of statistics displayed on object properties forms?

21.18.1 Purpose

By default, the NFM-P displays the statistics records collected during the past hour on the Statistics tab on object properties forms. Perform the procedure to modify the default time period of the statistics displayed on the Statistics tab of an object properties form.



CAUTION

Service Disruption

Consider possible service disruptions before modifying the statistics default time period.

Changing the default time period for the NFM-P Statistics Manager search filters can affect the performance of the NFM-P.

21.18.2 Steps

- 1 _____
Choose Application→Exit to close the NFM-P client GUI, if it is open. The NFM-P client GUI closes.
- 2 _____
Navigate to the client configuration directory, typically /opt/nsp/client/nms/config on RHEL, and C:\nsp\client\nms\config on Windows.

-
- 3 _____
Open the nms-client.xml file using a text editor.
 - 4 _____
Locate the section that begins with the following XML tag:

```
<statistics
```
 - 5 _____
Edit the following line to read:

```
tabDefaultHour="value"
```

where *value* is the default number of hours for the Past <number_of_hours> filter
 - 6 _____
Save the changes and close the nms-client.xml file.
 - 7 _____
Log in to an NFM-P GUI client to verify that the new value is displayed on the Statistics tab of an object properties form.

END OF STEPS _____

21.19 How do I enable the preservation of the XML API statistics pool size?

21.19.1 Purpose



CAUTION

Service Disruption

Modifying the server configuration can have serious consequences including service disruption.

Contact technical support before you attempt to modify the server configuration.

Perform this procedure to ensure that the pool size for XML API statistics operations is not reset by a system upgrade or main server configuration update.

i **Note:** You must perform the procedure on each main server in the NFM-P system.

21.19.2 Steps

- 1 _____
Log in to the main server station as the nsp user.

How do I enable the preservation of the XML API statistics pool size?

2

Open a console window.

3

Navigate to the `/opt/nsp/nfmp/server/nms/config` directory.

4

Create a backup copy of the `nms-server.xml` file.

5

Open the `nms-server.xml` file using a plain-text editor such as `vi`.

6

Locate the following line:

```
<deploymentWorker statsPoolSize="nn"
```

7

Add the following to the end of the line:

```
preserveAttributes="true"
```

The line now reads:

```
<deploymentWorker statsPoolSize="nn" preserveAttributes="true"
```

8

Save and close the file.

9

Navigate to the `/opt/nsp/nfmp/server/nms/bin` directory.

10

Enter the following:

```
bash$ ./nmserver.bash read_config ↵
```

The main server configuration is updated.

11

Close the console window.

END OF STEPS

21.20 How do I configure auto-assigned service ID ranges and uniqueness checking?

21.20.1 Purpose



CAUTION

Service Disruption

Modifying the NFM-P system configuration can have serious consequences that include service disruption.

Contact technical support before you attempt to modify the server configuration.



CAUTION

Misconfiguration risk

You must configure each main server in the NFM-P system using the same values, as described in the procedure; otherwise, a potentially service-affecting configuration mismatch exists.

If you perform the procedure, ensure that you perform the procedure on each main server station.

By default, the NFM-P performs uniqueness checking to verify that a service ID that is to be auto-assigned is not currently associated with a service in the NFM-P managed network. Service creation using auto-assigned service IDs can take considerable time, and consume system resources unnecessarily, if the NFM-P manages a large number of services.

To avoid such a scenario, you can configure a range of service IDs for auto-assignment, and disable the uniqueness checking for the specified range.

Perform this procedure to :

- configure the system-wide default minimum and maximum values for auto-assigned service IDs
- disable or enable the uniqueness checking of service IDs during service creation



Note: When uniqueness checking is disabled for a range, a value in the range cannot be used as a service ID for the following. or an error is logged and the service creation fails:

- manually created service
- service created using a range policy, if the ranges in the range policy and server configuration overlap to any extent



Note: The order in which you configure the main servers is unimportant, but you must perform the procedure on each main server before you attempt automatic service creation using the specified service ID range.

21.20.2 Steps

1

Log in to the main server station as the nsp user.

2 _____

Open a console window.

3 _____

Navigate to the `/opt/nsp/nfmp/server/nms/config` directory.

4 _____

Create a backup copy of the `nms-server.xml` file.

5 _____

Open the `nms-server.xml` file using a plain-text editor such as `vi`.

6 _____

Locate the section that begins with the following line:

```
<idManager>
```

The section describes the ID ranges for which you can configure the minimum and maximum values.

7 _____

Add a `serviceld` range entry with uniqueness checking disabled to the `<idManager>` section, for example:

```
<range
  name="serviceId"
  min="minimum_value"
  max="maximum_value"
  skipIdCheck="true" />
```



Note: The `skipIdCheck` parameter can have one of the following values:

- `true`—disables the uniqueness check
- `false`—enables the uniqueness check



Note: Before you set `skipIdCheck` to `true` for a service ID range, you must ensure that no existing service in the NFM-P managed network has a service ID in the range.

8 _____

Save and close the file.

9 _____

On a standalone main server, or the primary main server in a redundant system, enter the following:

```
bash$ /opt/nsp/nfmp/server/nms/bin/nmserver.bash read_config ↵
```

How do I configure auto-assigned service ID ranges and uniqueness checking?

The NFM-P puts the configuration change into effect.

10

Close the console window.

END OF STEPS

NFM-P alarm administration

21.21 What are alarm thresholds?

21.21.1 Escalation and de-escalation thresholds

For alarms that occur repeatedly, you can set thresholds in an alarm policy to escalate and de-escalate the severity of the alarm; see [21.27 “How do I configure alarm policies?” \(p. 552\)](#). Escalation to a higher severity can alert you to a problem when an alarm is occurring too often, or occurs too many times. De-escalation restores a lower level of severity when the alarm occurs less often. Configured thresholds are applied immediately once the updated policy is saved.

You can set more than one escalation threshold and de-escalation threshold in a policy, so severity for a particular alarm type can be increased or decreased more than once if required.

You can configure any higher severity level for escalation, and any lower level for de-escalation; it doesn't have to be an adjacent severity level.

[Figure 21-1, “Alarm escalation without de-escalation” \(p. 546\)](#) shows how an escalation policy will increase the severity setting of an alarm based on a specified frequency threshold. The severity is increased twice: from minor to major, and then from major to critical, based on two threshold values for the Frequency parameter. In this case, no de-escalation threshold is applied, so the alarm remains at critical severity even when the frequency falls below the threshold again.

Figure 21-1 Alarm escalation without de-escalation

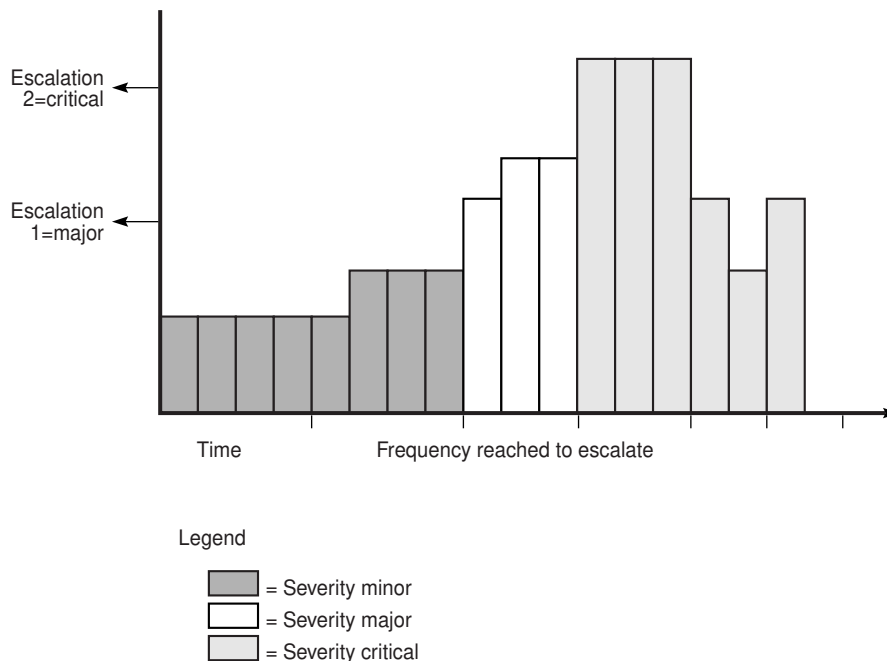

17357

Note: When no de-escalation policy is applied, escalated alarms are not de-escalated once the frequency of the alarm is less than the alarm escalation threshold.

Figure 21-2, “Alarm escalation and de-escalation” (p. 546) shows changes in alarm severity when both escalation and de-escalation frequency thresholds are applied. An alarm reaches two configured frequency thresholds and is escalated twice: from minor to major, and from major to critical. Then, when the frequency reaches the specified values for de-escalation, the alarm severity is reduced again.

Figure 21-2 Alarm escalation and de-escalation

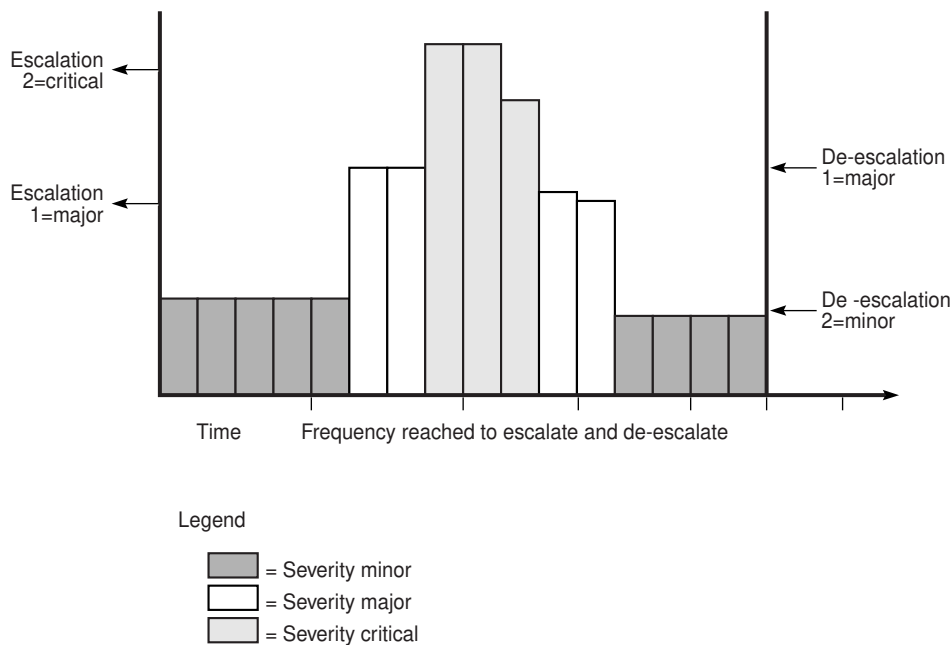

17538

Escalation thresholds can be based on frequency of occurrence of an alarm, or total number of occurrences, or both.

- The **Frequency** threshold is the number of times an alarm occurs within a specified interval. The default interval for an alarm policy is 24 hours, but you can modify this using the Interval parameter on the Specific Alarm Policy form. The NFM-P uses an internal mechanism to assess the frequency threshold each time the alarm occurs, so it is not necessary to wait for the full interval to elapse before escalation/de-escalation is triggered.
- The Occurrence threshold is the total number of occurrences of the alarm since the policy was applied; that is, since the default value of zero for the Occurrence parameter was changed for the policy. When the total number of occurrences of an alarm reaches this threshold, the alarm is escalated to the configured severity.

If the Occurrence threshold is deleted from a policy, existing alarms remain at their escalated severity. However, the next occurrence and all subsequent occurrences will show the severity configured in the Initial Severity Assignment (unless they reach another configured threshold).

Frequency and Occurrence thresholds are independent of each other; the alarm is escalated when either of the thresholds is reached. At least one of the thresholds (Frequency or Occurrence) must be set to a value other than zero for escalation to occur. If a value is set to zero then that threshold is ignored and no escalation occurs for that threshold.

De-escalation thresholds are based only on frequency. If the Frequency parameter is set to zero then the threshold is ignored for frequency changes and no de-escalation occurs.

You must enable the Escalation and De-Escalation check boxes on the Specific Alarm Policy form for their associated thresholds to be applied.

Additionally, policy-based escalation and de-escalation is controlled on the Alarm Settings form, General tab. You must enable the Allow Policy Based Escalation and Allow Policy Based De-escalation parameters in the Alarm Severity Settings panel, in the Automatic sub-panel; see [21.28 “How do I configure alarm severity and deletion behavior?”](#) (p. 554).

Acknowledging an alarm does not affect escalation policies. Deleting an alarm affects the frequency counter; see [21.28 “How do I configure alarm severity and deletion behavior?”](#) (p. 554).

Escalation policies are affected by the Auto Deletion Rule parameter of the global alarm deletion policy. See [21.28 “How do I configure alarm severity and deletion behavior?”](#) (p. 554) for more information. When an escalation policy uses the “Delete Alarms when Cleared” default option for the Automatic Alarm Deletion Settings parameter, the escalation policy is not applied, unless alarm debouncing is enabled for the particular alarm type. You must configure the parameter to a value other than “Delete Alarms when Cleared” to ensure that the escalation policy is applied.

21.22 What is alarm suppression?

21.22.1 Overview

The NFM-P is designed to not generate alarms when numerous SNMP traps are sent in quick succession for the same type of event. This prevents alarm storms during intermittent outages in the network caused by bouncing NEs; for example, if links go up and down rapidly. The NFM-P continues to resynchronize the network. If the bouncing NEs continue to send down state SNMP traps, the NFM-P eventually receives the trap and generates the appropriate alarm.

To indicate how often an alarm is generated, the number of occurrences of each instance of the alarm is tracked in the alarm record of the initial alarm. Click on the Statistics tab of an Alarm Info form to display how often the alarm was generated.

To escalate the alarm severity if an alarm reoccurs a specific number of times, use the threshold crossing alert functionality. Configure the escalation or the de-escalation parameter as described in [21.27 “How do I configure alarm policies?”](#) (p. 552) .

The NFM-P uses a trap throttling process to prevent the NFM-P system from being overloaded with traps if a failure occurs. Trap throttling does not affect the sequencing of traps. The trap throttling process allows the NFM-P to process traps when time permits. As a result, the NFM-P keeps track of the traps that the software missed and resynchronizes only the missed traps. Trap throttling is

supported and configured using the CLI on each Nokia NE. See the NE System Management Guides for configuration information.

21.23 What is the alarm purge algorithm?

21.23.1 Overview

Because a large number of outstanding alarms can affect system performance, the NFM-P purges outstanding alarms. The alarm purge algorithm sorts alarms using the following criteria:

- lower severity alarms are deleted before higher severity alarms
- within a severity, the oldest alarms are always deleted first

i **Note:** The alarm purge algorithm is not applied to the following correlating—or root cause—alarms unless the red threshold has been crossed:

- EquipmentRemoved
- EquipmentMismatch
- EquipmentDown
- EquipmentAdministrativelyDown
- ContainingEquipmentMissing
- ContainingEquipmentMismatch
- ContainingEquipmentAdministrativelyDown
- ContainingEquipmentOperationallyDown
- TunnelDown
- TunnelAdministrativelyDown
- AccessInterfaceDown
- SdpBindingDown

When an alarm policy does not exist, the NFM-P purges alarms as follows:

For collocated systems:

- If the outstanding alarm count reaches 45 000, the NFM-P:
 - raises an alarm to indicate that an alarm purge is in progress
 - purges non-critical alarms not in the exclusions list to the historical alarm log until the count drops to 45 000
- If the outstanding alarm count reaches 60 000, the NFM-P:
 - raises an alarm to indicate that an alarm purge is in progress
 - purges alarms to the historical alarm log, starting with the oldest lowest severity alarms, until the count drops to 45 000
 - displays “Max alarm count exceeded” in the status bar

For distributed systems:

- If the outstanding alarm count reaches 200 000, the NFM-P:

-
- raises an alarm to indicate that an alarm purge is in progress
 - purges non-critical alarms not in the exclusions list to the historical alarm log until the count drops to 200 000
 - If the outstanding alarm count reaches 250 000, the NFM-P:
 - raises an alarm to indicate that an alarm purge is in progress
 - purges alarms to the historical alarm log, starting with the oldest lowest severity alarms until the count drops to 200 000
 - displays “Max alarm count exceeded” in the status bar

To ensure that purged alarms are logged, you must enable alarm history logging. See [21.29 “How do I configure alarm history logging?” \(p. 555\)](#) for information about configuring alarm history logging and purging policies.

21.24 What is automatic deletion of correlated alarms?

21.24.1 Overview

You can configure the NFM-P to automatically delete correlated alarms when the correlating alarm is deleted, as described in [21.28 “How do I configure alarm severity and deletion behavior?” \(p. 554\)](#). You can also configure NFM-P alarm settings to specify whether a user notification is displayed before you delete one or more correlated alarms.

To prevent cleared alarms from persisting in the NFM-P, alarm severity is not promoted by alarm correlation when you choose one of the following options for automatic alarm deletion. The options disable the correlation of alarm severity in the NFM-P network.

- Disable Automatic Alarm Deletion
- Delete Alarms when Acknowledged
- Delete Alarms when Cleared and Acknowledged

 **Note:** A correlated alarm is not deleted after the deletion of the correlating alarm if there is another correlating alarm associated with the correlated alarm. Therefore, the number of correlated alarms that are automatically deleted may be less than the number in the warning notification to a GUI operator.

21.25 What is alarm debouncing?

21.25.1 Overview

Bouncing alarms, or flapping alarms, occur when an alarm is raised and cleared several times by the network within a short period of time. For example, an alarm can be generated several thousand times in a 24-hour period. When an alarm is generated, the alarm is typically cleared very shortly after being raised.

Alarm debouncing using the NFM-P allows you to detect and reduce the number of deleted, or cleared, alarms that are logged in the historical database, while allowing alarm events and related statistics to be kept up to date.

You can configure debouncing on alarm policies for implicitly cleared alarms only, that is, alarms which are automatically cleared by the NFM-P when a condition is met. You can configure alarm debouncing only on policies for which the auto-deletion rule cannot be configured, in which case “N/A” appears under the Auto Deletion Rule column on the Policies tab of the Alarms Settings form. Alarm debouncing is not configurable for policies for which No Deletion Rule or a configured deletion rule appears under the Auto Deletion Rule column on the Policies tab of the Alarm Settings form.

Although alarm events that occur are processed normally when alarm debouncing is enabled, alarm clear events that occur are not processed immediately. The alarm clear events are held in a separate cache until the hold period, which you configure in the debouncing policy, has elapsed. If another clear event occurs before the hold period has elapsed for the previous clear event of the same alarm, the more recent clear event replaces the older clear event in the cache. After the hold period has elapsed, the alarm clear event is removed from the cache, queued and processed.

If an alarm clear event is on hold in the cache and an alarm raise event for that same alarm is received, the clear event is removed from the cache and dropped. Because the alarm was not cleared and not raised again, the raise event is processed as an update event and the existing alarm instance is updated.

When an escalation policy uses the “Delete Alarms when Cleared” default option for the Automatic Alarm Deletion Settings parameter, the escalation policy is not applied, unless alarm debouncing is enabled for the particular alarm type. See [21.28 “How do I configure alarm severity and deletion behavior?” \(p. 554\)](#) for more information about how to configure escalation policies.

See [21.31 “How do I configure alarm debouncing ?” \(p. 557\)](#) for information about how to configure alarm debouncing policies.

 **Note:** E-mail notifications that you can configure send E-mails for alarm create events. However, if you have enabled E-mail notifications for alarm events and alarm debouncing is also enabled, any new alarms that are raised within the debounce interval are handled as an update and not a create event, and no E-mail is sent.

21.25.2 Purging the debouncing cache

By default, up to 5000 clear events for different alarms can be held in the debouncing cache at one time.

When the alarm debouncing cache reaches capacity with excess bouncing alarms, the NFM-P raises the AlarmDebouncingThresholdReached alarm. When this occurs, alarm debouncing is temporarily disabled and at least 70% of the alarm clear events that are being debounced are processed immediately. Alarm debouncing is re-enabled after the processing of cached events completes.

21.25.3 XML API and alarm debouncing

When debouncing is enabled, JMS listeners handle alarm events received differently from when debouncing is disabled. For example, when a raise/clear raise/clear raise/clear sequence occurs when debouncing is not enabled, JMS listeners receive and handle one update event, but the three clear events are processed by the NFM-P, and three historical alarms are logged. When this sequence occurs when debouncing is enabled, JMS listeners receive and handle a raise, update, update, clear, and only one clear event is processed by the NFM-P.

21.26 How do I filter alarms for XML API clients using the NFM-P GUI?

21.26.1 Overview

You can use a GUI client to configure an alarm filter for XML API clients. See [21.32 “How do I configure alarm filters for XML API clients?”](#) (p. 557) and the *NSP NFM-P XML API Developer Guide*.

Consider the following:

- Only public filters can be applied to XML API clients.
- When a user logs in to the NFM-P GUI, filters that were created for XML API applications are not applied to GUI alarms.
- Filters that are applied using the NFM-P GUI apply only to the fault (5620-SAM-topic-xml-fault) and filter (5620-SAM-topic-xml-filtered) JMS topics.
- When the NFM-P GUI is used to apply or remove a filter, you do not need to disconnect or reconnect an XML API session.
- When a filter is defined and enabled, and the client does not have an XML API connection, the filter is applied when the XML API client connects.
- When a filter is defined and enabled, and the user has one or more XML API connections, the filter is applied to all of the user XML API connections.
- When an alarm filter is in use with an XML API session and an NFM-P operator changes the contents of the filter, the NFM-P user is informed that the filter is in use and who is using the filter. The NFM-P user is prompted with the option to save the change or cancel the change.
- Alarm filters that are applied to XML API sessions appear in the Sessions tab on the NFM-P User Security-Security Management form.

21.27 How do I configure alarm policies?

21.27.1 Purpose

The NFM-P provides default alarm policies for alarms. You can modify the default settings of these policies.

Perform the following procedure to modify the initial severity assignment, assign urgency levels, enable alarm history, add custom text, and configure other settings for one or more alarm types.

For specific alarm types, you can set thresholds for escalation and de-escalation of alarm severity; see [21.21 “What are alarm thresholds?”](#) (p. 546).

21.27.2 Steps

1

Choose Administration→Alarm Settings from the NFM-P main menu. The Alarm Settings form opens.

2

Click on the Policies tab and perform one of the following:

- a. Configure settings for a specific alarm policy, including escalation and de-escalation thresholds, if required. Go to [Step 3](#).
- b. Configure settings for multiple alarm policies. Go to [Step 9](#).

 **Note:** You cannot configure alarm thresholds for multiple policies at the same time.

3

Choose an alarm type. The alarm types are listed by *policyGroup.AlarmPolicy*.

 **Note:** You can determine the applicable alarm policy for an alarm by searching for the base alarm name in the *NFM-P Alarm Search Tool*. The name format is *package.AlarmName*. For example, the GlobalAppProfileCreated alarm search result shows that the alarm is associated with the aapolicy.GlobalAppProfileCreated policy.

4

Click Properties. The Specific Alarm Policy (Edit) form opens.

5

Configure the required parameters on the General tab.

6

Configure escalation thresholds for the alarm type.

1. Enable the Escalation parameter.
2. Choose a threshold in the list and click Properties, or click Add. The Escalation Threshold form opens.
3. Configure the required parameters.

For the Frequency parameter, the interval used is displayed on the form. The Interval parameter is configured in [Step 5](#).

You can configure both Frequency and Occurrence in the same escalation threshold.

The Severity parameter specifies the severity level the alarm will be escalated to, and must be a higher severity than the Initial Severity Assignment configured in [Step 5](#).

4. Click OK to close the Escalation Threshold form.
5. Configure additional thresholds as required.

7

Configure de-escalation thresholds for the alarm type.

1. Enable the De-escalation parameter.
2. Choose a threshold in the list and click Properties, or click Add. The De-Escalation Threshold form opens.
3. Configure the required parameters.

For the Frequency parameter, the interval used is displayed on the form. The Interval parameter is configured in [Step 5](#).

The Severity parameter specifies the severity level the alarm will be de-escalated to.

4. Click OK to close the De-Escalation Threshold form.
5. Configure additional thresholds as required.

8

Go to [Step 12](#) .

9

Shift-click to choose multiple alarms. The alarm types are listed by *policy group.alarm policy*.



Note: When you attempt to modify the configuration of multiple alarm policies at one time, the configuration is limited to the elements that the alarm policies have in common.

10

Click Properties. The Specific Alarm Policy (Edit) form opens.

11

Configure the required parameters on the General tab.

12

Save your changes and close the forms.

END OF STEPS

21.28 How do I configure alarm severity and deletion behavior?



Note: You must have a user account with the administrator scope of command role or write access to the fm.GlobalPolicy class to perform this procedure.

21.28.1 Steps

1

Choose Administration→Alarm Settings from the NFM-P main menu. The Alarm Settings form opens.

2

In the Alarm Severity Settings panel, enable or disable alarm severity settings and specify the behavior for automatic and manual alarm settings.

Use the following steps:

1. Configure the Enable Severity Settings parameter, as required. You cannot configure additional parameters in the Alarm Severity Settings panel unless the parameter is enabled.
2. Configure the required parameters in the Manual panel.
3. Configure the required parameters in the Automatic panel.

3



CAUTION

Service Disruption

Deleting an alarm resets the frequency of the alarm to 1.

This may cause conflicts with configured alarm escalation and de-escalation policies.

In the Alarm Deletion Settings panel, enable or disable alarm deletion settings and specify the behavior for manual and automatic alarm deletion settings.

1. Configure the Enable Deletion Settings parameter. You cannot configure parameters in the Alarm Deletion Settings panel unless the parameter is enabled.
2. Configure the other parameters in the Alarm Deletion Settings panel, as required.

4

See [21.29 "How do I configure alarm history logging?" \(p. 555\)](#) for information about configuring parameters in the Alarm History DB Behavior panel.

5

Configure the Alarm Event Settings.

6

To reset all parameters on the General tab to their default values, click Reset To Default.

7

Save your changes and close the form.

END OF STEPS

21.29 How do I configure alarm history logging?

21.29.1 Purpose

The NFM-P stores alarms in the alarm history database for record-keeping and trend analysis. You can specify when alarms are logged to the alarm history database.

i **Note:** When the maximum number of alarms allowed in the alarm history database is reached, the NFM-P deletes the oldest alarms. If you need to save information about the alarms, save a file that contains the alarm log information, as described in the *NSP NFM-P User Guide*.

21.29.2 Steps

1 _____
Choose Administration→Alarm Settings from the NFM-P main menu. The Alarm Settings form opens.

2 _____
Configure the required parameters in the Alarm History DB Behavior panel.

i **Note:** Nokia recommends that you enable the Log On Deletion parameter to ensure that the alarm history log records all deleted alarms.

3 _____
To reset all parameters on the General tab to their default values, click Reset To Default.

4 _____
Save your changes and close the form.

END OF STEPS _____

21.30 How do I show or hide the alarm Additional Text button?

21.30.1 Steps

1 _____
Choose Administration→Alarm Settings from the NFM-P main menu. The Alarm Settings form opens.

2 _____
Click on the Additional Text tab and enable or disable the Show Additional Text Button on Properties Forms parameter.

-
- 3 _____
Save your changes and close the form.

END OF STEPS _____

21.31 How do I configure alarm debouncing ?

21.31.1 Steps

- 1 _____
Choose Administration→Alarm Settings from the NFM-P main menu. The Alarm Settings form opens.
- 2 _____
Click on the Policies tab and choose one or more alarm policies. In the policies table, only policies which show "N/A" under Auto Deletion Rule are configurable with alarm debouncing. If you select one or more alarm policies for which the Auto Deletion Rule parameter is a value other than "N/A", the alarm debouncing parameters do not appear.
- 3 _____
Choose the policy and click Properties. The Specific Alarm Policy (Edit) form opens.
-  **Note:** You can also open the Specific Alarm Policy (Edit) form from the Alarm Info form, by clicking on the View Policy button.
- 4 _____
Configure the Enable Alarm Debouncing parameter.
- 5 _____
Configure the Hold Period (seconds) parameter to specify the debouncing time interval. If you are enabling alarm debouncing for this policy for the first time, the default value is automatically set to 180. If alarm debouncing was previously enabled, then disabled, the value of the Hold Period (seconds) parameter remains as the last configured value.
- 6 _____
Save and close the forms.

END OF STEPS _____

21.32 How do I configure alarm filters for XML API clients?

21.32.1 Purpose

Perform this procedure to configure a filter to control or limit the alarms that the NFM-P forwards to XML API clients over JMS. See [21.26 "How do I filter alarms for XML API clients using the NFM-P GUI?"](#) (p. 552) and the *NSP NFM-P XML API Developer Guide* for more information.

 **Note:** In order to perform the procedure, you require a user account with XML API access.

21.32.2 Steps

- 1 _____
Choose Administration→Security→NFM-P User Security from the NFM-P main menu. The NSP NFM-P User Security - Security Management (Edit) form opens.
- 2 _____
Click on the Users tab.
- 3 _____
Choose a user from the list and click Properties. The User (Edit) form opens.
- 4 _____
In the XML API Session panel, click Select to assign a public alarm filter. The Select Public Alarm Filter for XML API form opens.
- 5 _____
Perform one of the following:
 - a. Select a filter in the list. Go to [Step 6](#) .
 - b. Create an alarm filter.
Use the following steps:
 1. Click Create. The Create AlarmObject Filter form opens.
 2. Configure an appropriate filter for the XML API client by selecting a filter from the Attribute parameter pull-down menu. You can modify the filter string to meet the operational requirements for an XML API client by configuring the Function, Value, and Operators pull-down menus as appropriate.
 3. Click Add to add the filter.
 4. Add additional filter criteria for the alarm filter as required.
 5. Click Save. The Save Filter form opens.
 6. Configure the required parameters.

Note:

The Public parameter must be enabled. Only public filters are applied to XML API clients.

7. Save your changes and close the Save Filter and Select Public Alarm Filter for XML API forms.

6

Choose the newly created filter from the list, and click OK. The Select Public Alarm Filter for XML API-User form closes, and the selected filter is applied.

7

Save your changes and close the forms.

END OF STEPS

21.33 How do I reload all alarms from the historical alarm database?

21.33.1 Purpose

The NFM-P uses an alarm service to cache alarm information. To ensure the cache is current with all alarms stored in the historical alarm database, administrators can reload all alarms from the database. To perform this procedure, you must have a user account with the administrator scope of command role or a scope of command role with write access permissions to the fm.FaultManager class.



CAUTION

Service Disruption

After the procedure is complete, client GUI users viewing open alarm forms and windows may have out-of-date information. Operators must close all open windows and forms, then relaunch -open the windows or forms. This includes windows and forms that display alarm status information, for example, the navigation tree.

21.33.2 Steps

1

Choose Administration→Reload Alarm Information from the NFM-P main menu.

2

Click OK to confirm you are aware that all other users will be affected by the alarm reload.

Alarm information is reloaded and all active client GUIs are updated with the confirmation message that the alarms have been reloaded. Client GUI users can close and then reopen the Alarm Window to refresh the information.

END OF STEPS

21.34 How do I manually promote or demote the severity of an alarm?

21.34.1 Purpose

Operators with the appropriate scope of command permissions can change the severity of alarms when alarm settings are configured appropriately. See [21.28 "How do I configure alarm severity and deletion behavior?"](#) (p. 554) for more information about configuring global alarm settings.

21.34.2 Steps

1

Perform one of the following to open the Severity Assignment form:

a. From the dynamic alarm list:

Use the following steps:

1. Filter the alarms. See the *NSP NFM-P User Guide* for information about creating search filters.
2. Right-click on an alarm in the list and choose Assign Severity. The Severity Assignment form opens and displays the selected alarm(s).

b. From the alarm list on the Faults tab of the object properties form:

Use the following steps:

1. Open the object properties form for the required object.
2. Click on the Faults tab.
3. Click on a sub-tab. A list of object alarms appears.
4. Filter the alarms. See the *NSP NFM-P User Guide* for information about creating alarm filters.
5. Right-click on an alarm in the list and choose Assign Severity. The Severity Assignment form opens and displays the selected alarm(s).



Note: You can choose multiple alarms at the same time. When you choose multiple alarms, the new severity level is applied to all selected alarms.

2

Configure the Assigned Severity parameter.



Note: Before you close the form, you can click Reset to restore the original severity setting.

3

Save the changes and close the forms.

END OF STEPS

21.35 How do I create an alarm e-mail policy?

21.35.1 Purpose

An NFM-P administrator can create up to five policies for e-mail notifications with alarm notification rules and a list of recipients. When a filter is matched, an e-mail is sent to the list of recipients. The e-mail content is a set of text-based alarm fields and a link to the relevant functional area.



Note: You require specific permissions to use the Impact Analysis tool. Contact your system administrator for more information.

Your administrator must ensure that the outgoing SMTP e-mail server is configured.

LI alarms are not sent in the e-mails.

E-mails are not sent for alarm attribute change events, only for alarm creation. For example, if an alarm is created with a severity of major, and the severity is subsequently changed to critical, alarm e-mail policy filters for critical alarms will not include this alarm.

When you modify the e-mail policy properties form, the e-mail counts for the e-mail policy are reset. If you select a different filter for the e-mail policy, the e-mail counts are reset. If you modify the contents of the saved filter from the alarm table, the e-mail counts for the e-mail policy are not reset.

21.35.2 Steps

- 1 _____
Choose Administration→Alarm Settings from the NFM-P main menu. The Alarm Settings form opens.
- 2 _____
Click on the E-mail tab and click Create. The Alarm Email Filter (Create) form opens.
- 3 _____
Configure the Name and Max Emails Per Hour parameters.
- 4 _____
Select an alarm filter. To configure and apply an advanced search filter using the filter configuration form, see the *NSP NFM-P User Guide* for information.
- 5 _____
Click on the Users tab, then on Add to create a list of e-mail recipients. The e-mail is sent to the e-mail address configured for the selected users.
You can add up to 20 users as recipients of an e-mail for each policy.
- 6 _____
Save the changes and close the forms.

END OF STEPS _____

21.36 How do I optimize alarm event notifications?

21.36.1 Purpose

The alarm event buffer receives all alarm events that must be broadcast to JMS clients. For optimization purposes, the buffer fills up alarm events and flushes the queue every 3 seconds. During these 3 seconds, if a creation event is queued followed by a deletion event for that same object, both of these events cancel each other out, and no event is sent. However, the alarm corresponding to the deletion event is still logged into historical alarms.

You can disable the canceling of creation and deletion event pairs. All of the events are reported to all subscribed JMS listeners and are displayed in the Active Alarm list of each GUI client. When this option is deselected, the user receives a warning that this will impact alarm event processing. If optimization is not enabled, third-party JMS listeners may not be able to manage the increased event rate.

21.36.2 Steps

1

Choose Administration→Alarm Settings from the NFM-P main menu. The Alarm Settings form opens.

2

Ensure the Optimize Alarm Event Notifications parameter is enabled.

3

Save the changes and close the form.

END OF STEPS

NFM-P license management

21.37 What are NFM-P licenses?

21.37.1 NFM-P licenses

To enable the options or equipment capacity specified in a new license, you must import the license file on each NFM-P main server, as described in [21.40 “How do I update the NFM-P license in a standalone deployment?” \(p. 565\)](#) and [21.41 “How do I update the NFM-P license in a redundant deployment?” \(p. 567\)](#). If required, you can uncompress a license file and view the license information, which is in XML format.

You can view the current NFM-P license specifications from the NFM-P license information form; see [21.38 “How do I view the NFM-P license information?” \(p. 564\)](#) for information. The form displays the following, which you can export to a file, if required:

- NFM-P software release and patch level
- main servers associated with the license
- licensed NFM-P feature packages
- number of licensed operator positions, other allowances
- license points consumed and remaining
- extended NE software support

See [21.39 “How do I export the NFM-P license information or create a license point inventory?” \(p. 565\)](#) for export information.

21.37.2 Managing NE license consumption

When an NFM-P license-point limit is reached, the NFM-P does not discover additional equipment of the type to which the limit applies.

From the NFM-P license information form, you can generate a license inventory file that lists the NFM-P license points consumed per object per managed NE, and per AA subscriber type. The objects are ordered by NE site ID and by subscriber type; the information for each includes the following:

- object FDN, for equipment
- associated site ID, for equipment
- licensed product name
- number of license points that the object consumes

See [21.39 “How do I export the NFM-P license information or create a license point inventory?” \(p. 565\)](#) for information.

License consumption by a specific NE

The license consumption information for a specific NE is viewable from the Inventory tab of the NE properties form. The tab lists the license information for cards, blades, chassis, and other NE equipment. See “Inventory management” in the *NSP NFM-P User Guide* for more information.

License consumption by specific equipment

The Manage Equipment form displays license consumption information specific to a type of equipment, for example, a physical card.

21.38 How do I view the NFM-P license information?

21.38.1 Steps

1

To view the NFM-P license information in the client GUI:



Note: You can also list equipment license information for one NE or the entire network using the NFM-P Equipment Manager; see “Inventory management” in the *NSP NFM-P User Guide*.

1. Choose Help→License Information from the NFM-P main menu. The NSP Network Functions Manager - Packet License (Edit) form opens.
2. View the license information in the following panels:
 - License Information—basic license and system information
 - Feature Packages—installed NSP feature packages
 - Options—optional management function capacities
 - Licensed Limits—the number of consumed and remaining license points for capacity-based licensing objects such as equipment
3. A highlighted entry in the Licensed Limits panel is alarmed, and may indicate that the license capacity is approaching or has reached the license limit. To view the current alarms against an entry, double-click on the entry and click on the Faults tab of the form that opens.
4. Close the open forms, as required.

2



CAUTION

Service Disruption

An NFM-P license file is digitally signed. If you rename or modify the license XML file, the NFM-P rejects the license.

Do not rename or modify the XML file inside a compressed license file.

To verify the contents of an NFM-P license file, for example, if you are unsure which file contains a specific license option or number of license points:



Note: A license file does not include an object that has a licensed quantity of zero.

1. Uncompress the license zip file.
2. View the contents of the contained XML file.

3. Close the file.

END OF STEPS

21.39 How do I export the NFM-P license information or create a license point inventory?

21.39.1 Steps

1

Choose Help→License Information from the NFM-P main menu. The NSP Network Functions Manager - Packet License (Edit) form opens.

2

To export the form information to a file, perform the following steps.

1. Click Export License information to file. A Save as form opens.
2. Specify a name, location, and format for the file that is to contain the license information.
3. Click Save. The license information is saved in the specified file.

3

To create a license point inventory, perform the following steps.



Note: The license point inventory file is saved in XML format.

1. Click License Points Inventory. A Save as form opens.
2. Specify a name and location for the file that is to contain the license inventory.
3. Click Save. The license point inventory is saved in the specified file.

4

Close the NFM-P License (Edit) form.

END OF STEPS

21.40 How do I update the NFM-P license in a standalone deployment?

21.40.1 Steps

1

Log in to the main server station as the nsp user.

2

Open a console window.

3 _____
Navigate to the `/opt/nsp/nfmp/server/nms/bin` directory.

4 _____
Enter the following:
`bash$./nmserver.bash import_license license_file ↵`
where `license_file` is the absolute file path of the NFM-P license zip file

The following prompt is displayed:
`Detected an NFM-P license key. Do you want to proceed? (YES/no):`

5 _____
Enter the following:
`YES ↵`
The main server reads the license file, copies the license file to a backup location, and displays the following status information:

```
Importing NFM-P license key...  
Original license key file has been backed up to  
/opt/nsp/nfmp/server/timestamp/SAMLicense.zip  
Done.
```

where `timestamp` is a directory name in the following format: `yyyy.mm.dd-hh.mm.ss`

6 _____
Close the console window.

Restart auxiliary servers

7 _____
In order to apply the license values to an NFM-P auxiliary server, you must restart the auxiliary server.

If the NFM-P deployment includes one or more auxiliary servers, restart each auxiliary server station.

1. Log in to the auxiliary server station as the `nsp` user.

2. Open a console window.

3. Enter the following:

```
bash$ cd /opt/nsp/nfmp/auxserver/nms/bin ↵
```

4. Enter the following:

```
bash$ ./auxnmserver.bash auxforce_restart ↵
```

The auxiliary server restarts.

5. Close the console window.

Verify new license information

8

Perform [21.38 “How do I view the NFM-P license information?” \(p. 564\)](#) to verify the imported license information.

9

If a license parameter is incorrect, contact technical support for assistance.

END OF STEPS

21.41 How do I update the NFM-P license in a redundant deployment?



Note: The license files that you import to the primary and standby main servers must contain identical license quantity and option values.



Note: To reduce the risk of importing mismatched licenses, it is recommended that you obtain one license file that contains the system ID of each main server, and then import the same file on each main server.



Note: The primary and standby main server licenses must be synchronized to ensure correct NFM-P operation in the event of a server activity switch. The main servers compare license values after a system reconfiguration. If a difference is detected, the NFM-P raises an alarm that you can clear when the licenses are synchronized.

21.41.1 Steps

Update license on primary main server

1

Open a client GUI to monitor the NFM-P during the license update.

2

Log in to the primary main server station as the nsp user.

3

Open a console window.

4

Navigate to the `/opt/nsp/nfmp/server/nms/bin` directory.

5

Enter the following:

```
bash$ ./nmserver.bash import_license license_file ↵
```

How do I update the NFM-P license in a redundant deployment?

where *license_file* is the absolute file path of the NFM-P license zip file

The following prompt is displayed:

```
Detected an NFM-P license key. Do you want to proceed? (YES/no):
```

6

Enter the following:

```
YES ↵
```

The primary main server reads the license file, copies the license file to a backup location, and displays the following status information:

```
Importing NFM-P license key...
```

```
Original license key file has been backed up to  
/opt/nsp/nfmp/server/timestamp/SAMLlicense.zip
```

```
Done.
```

where *timestamp* is a directory name in the following format: yyyy.mm.dd-hh.mm.ss



Note: Importing the new license on the primary main server creates a license mismatch with the standby main server. As a result, the NFM-P raises an alarm that you can clear when the license import on each main server is complete.

7

Close the console window.

Update license on standby main server

8

Log in to the standby main server station as the nsp user.

9

Open a console window.

10

Navigate to the `/opt/nsp/nfmp/server/nms/bin` directory.

11

Enter the following:

```
bash$ ./nmserver.bash import_license license_file ↵
```

where *license_file* is the absolute file path of the NFM-P license zip file

The following prompt is displayed:

```
Detected an NFM-P license key. Do you want to proceed? (YES/no):
```

12

Enter the following:

YES ↵

The standby main server reads the license file, copies the license file to a backup location, and displays the following status information:

```
Importing NFM-P license key...
```

```
Original license key file has been backed up to  
/opt/nsp/nfmp/server/timestamp/SAMLicense.zip
```

```
Done.
```

where *timestamp* is a directory name in the following format: yyyy.mm.dd-hh.mm.ss

13

Enter the following to restart the standby main server:

```
bash$ ./nmsserver.bash force_restart ↵
```

The main server restarts.

14

Enter the following:

```
bash$ ./nmsserver.bash appserver_status ↵
```

The server status is displayed; the server is fully initialized if the status is the following:

```
Application Server process is running. See nms_status for more  
detail.
```

If the server is not fully initialized, wait five minutes and then repeat this step. Do not perform the next step until the server is fully initialized.

15

Close the console window.

Restart auxiliary servers

16

In order to apply the license values to an NFM-P auxiliary server, you must restart the auxiliary server.

If the NFM-P deployment includes one or more auxiliary servers, restart each auxiliary server.

1. Log in to the auxiliary server station as the nsp user.
2. Open a console window.
3. Enter the following:

```
bash$ cd /opt/nsp/nfmp/auxserver/nms/bin ↵
```

4. Enter the following:

```
bash$ ./auxnmsserver.bash auxforce_restart ↵
```

-
- The auxiliary server restarts.
5. Close the console window.

Verify new license information

- 17

Perform [21.38 “How do I view the NFM-P license information?” \(p. 564\)](#) to verify the imported license information.
- 18

If a license parameter is incorrect, contact technical support.
- 19

After you verify that the license information is correct, clear the license mismatch alarm.
- 20

Close the GUI client, if it is no longer required.

END OF STEPS

21.42 How do I list the backed-up NFM-P license files?

21.42.1 Purpose

When you import an NFM-P license, the NFM-P creates a backup copy of the existing license file. The following steps describe how to list the NFM-P license files.

21.42.2 Steps

- 1

Log in to the main server station as the nsp user.
- 2

Open a console window.
- 3

Navigate to the `/opt/nsp/nfmp/server/nms/bin` directory.
- 4

Enter the following:

```
bash$ ./nmserver.bash import_license ↵
```

The command lists the files, as shown below:

The following backed up license key files have been detected on the system.

/opt/nsp/nfmp/server/timestamp1/SAMLicense.zip

/opt/nsp/nfmp/server/timestamp2/SAMLicense.zip

.
. .
.

where *timestamp1* and *timestamp2* are directory names in the following format: yyyy.mm.dd-hh.mm.ss

5

Close the console window.

END OF STEPS

21.43 How do I change the default NFM-P license expiry notification date?

21.43.1 Purpose

The NFM-P raises a daily warning alarm as the expiry date of the NFM-P license approaches. By default, the first alarm is raised seven days before the expiry date. Perform the procedure to change the default license expiry notification date.



CAUTION

Service Disruption

Modifying the nms-server.xml file can have serious consequences that can include service disruption.

Contact technical support before you attempt to modify the nms-server.xml file.



Note: You must perform the procedure on each main server in the NFM-P system.



Note: In a redundant system, you must perform the procedure on the standby main server station first.

21.43.2 Steps

1

Log in to the main server station as the nsp user.

2

Open a console window.

-
- 3

Navigate to the `/opt/nsp/nfmp/server/nms/config` directory.
 - 4

Create a backup copy of the `nms-server.xml` file.
 - 5

Open the `nms-server.xml` file using a plain-text editor such as `vi`.
 - 6

Locate the following tag in the `nms-server.xml` file:

```
<license
```
 - 7

Edit the following line in the section to read:

```
timedLicenseExpiryCount="value"
```

where *value* is the number of days to be notified before the license expiry
 - 8

Save and close the `nms-server.xml` file.
 - 9

On a standalone main server, or the primary main server in a redundant system, enter the following:

```
bash$ /opt/nsp/nfmp/server/nms/bin/nmsserver.bash read_config ↵
```

The NFM-P puts the configuration change into effect.
 - 10

Close the console window.
- END OF STEPS**

NFM-P network management configuration

21.44 How do I configure implicitly clearing alarm behavior for node reboots?

21.44.1 Purpose



CAUTION

Service Disruption

Modifying the NFM-P system configuration can have serious consequences that include service disruption.

Contact technical support before you attempt to modify the server configuration.

Use this procedure to specify that the alarm that is raised after an NE reboots is Implicitly Cleared for the following NEs: 7950 XRS, 7750 SR, 7705 SAR, 7705 SAR-H, 7450 ESS, 7250 IXR, and 7210 SAS.



Note: Enabling this function means that you may not be aware that an NE has rebooted.

21.44.2 Steps

- 1 _____
Log in to the main server station as the nsp user.
- 2 _____
Open a console window.
- 3 _____
Navigate to the /opt/nsp/nfmp/server/nms/config directory.
- 4 _____
Create a backup copy of the nms-server.xml file.
- 5 _____
Open the nms-server.xml file using a plain-text editor such as vi.
- 6 _____
Add the following entry:

```
<!--Configure the NFM-P to change "NodeRebooted" alarm to be  
"Implicitly Cleared".  
;The default value is "false". To change it as implicitly cleared  
make it "true"
```

```
;  
-->  
<NodeRebootedAlarm implicitlyCleared="true"/>
```

7 _____
Save and close the file.

8 _____
On a standalone main server, or the primary main server in a redundant system, enter the following:

```
bash$ /opt/nsp/nfmp/server/nms/bin/nmserver.bash read_config ↵
```

The NFM-P puts the configuration change into effect.

9 _____
Close the console window.

END OF STEPS _____

21.45 How do I configure backup-file retention for unmanaged NEs?

21.45.1 Purpose

The NFM-P saves NE configuration backup files on each main server, and by default deletes the backup files of unmanaged NEs. To retain backups for unmanaged NEs, you can:

- Manage the disk space consumed by NE configuration backups using the following procedures (recommended):
 - [21.72 “How do I back up the NE configuration files?”](#) (p. 614)
 - [21.73 “How do I restore the NE configuration files?”](#) (p. 615)
- Disable the automatic deletion of unmanaged NE backup files, as described in the following procedure.



CAUTION

Service Disruption

The procedure requires a restart of each main server, which causes a network management outage.

Perform the procedure only during a scheduled maintenance period.



CAUTION

Service Disruption

Modifying the server configuration can have serious consequences including service disruption. Contact technical support before you attempt to modify the server configuration.

i **Note:** You must perform the procedure on each NFM-P main server station.

i **Note:** You require nsp user privileges on each main server station.

21.45.2 Steps

1 _____
Log in to the main server station as the nsp user.

i **Note:** In a redundant system, you must perform the procedure on the standby main server station first.

2 _____
Open a console window.

3 _____
Navigate to the `/opt/nsp/nfmp/server/nms/config` directory.

4 _____
Create a backup copy of the `nms-server.xml` file.

5 _____
Open the `nms-server.xml` file using a plain-text editor.

6 _____
Locate the following lines:

```
;  
; <nodeBackups removeBackupOnDelete="false"/>  
;
```

7 _____
Edit the lines to read as shown below:

```
;-->  
<nodeBackups removeBackupOnDelete="value"/>  
<!--;
```

where *value* is true, to enable backup file deletion, or false, to disable deletion

-
- 8 _____
Save and close the nms-server.xml file.
- 9 _____
Navigate to the /opt/nsp/nfmp/server/nms/bin directory.
- 10 _____
Enter the following to restart the main server:

```
bash$ ./nmserver.bash force_restart ↵
```

The main server restarts.
-  **Note:** If you are restarting the primary main server in a redundant deployment, the network outage begins. The outage persists until the main server is fully initialized.
- 11 _____
Close the console window.
-
- END OF STEPS _____

21.46 How do I enable alarm reporting to identify duplicate NE system IP addresses?

21.46.1 Purpose

Enable the NFM-P to verify the uniqueness of NE system IP addresses.

When the verification is enabled, the NFM-P generates an alarm when an NE reports a system IP address that is in use by another NE.





CAUTION

Service Disruption

Modifying the server configuration can have serious consequences including service disruption.

Contact technical support before you attempt to modify the server configuration.

 **Note:** You must perform the procedure on each main server in the NFM-P system.

 **Note:** In a redundant system, you must perform the procedure on the standby main server station first.

21.46.2 Steps

-
- 1 _____
Log in to the main server station as the nsp user.

How do I enable alarm reporting to identify duplicate NE system IP addresses?

2 _____

Open a console window.

3 _____

Navigate to the `/opt/nsp/nfmp/server/nms/config` directory.

4 _____

Open the `nms-server.xml` file using a plain-text editor.

5 _____

Create a backup copy of the `nms-server.xml` file.

6 _____

Locate the section that begins with the following XML tag:

```
<snmp
```

7 _____

Insert the following before the section end, which is marked by a `/>` tag:

```
verifyNodeIdentity="1"
```



Note: If the inserted text and end tag are on the same line, you must include a space between the text and the end tag.

8 _____

Save and close the `nms-server.xml` file.

9 _____

On a standalone main server, or the primary main server in a redundant system, enter the following:

```
bash$ /opt/nsp/nfmp/server/nms/bin/nmsserver.bash read_config ↵
```

The NFM-P puts the configuration change into effect.

10 _____

Close the console window.

END OF STEPS _____

21.47 How do I enable dynamic system IP address updates for 7705 SAR nodes?

21.47.1 Purpose

Allow the NFM-P to react automatically when the IP address of a 7705 SAR node changes, for example, after acquiring a new address via DHCP. 7705 SAR NEs are uniquely identified in the network by the System ID parameter. Before you attempt to enable dynamic system IP address updates, please consider the following:

- The system ID of each 7705 SAR must be unique, or the NFM-P may update SDPs to point to an incorrect NE. You can configure the system ID parameter through CLI.
- All 7705 SAR NEs in the network must be unmanaged before you attempt to perform the procedure.



CAUTION

Service Disruption

Modifying the server configuration can have serious consequences including service disruption.

Contact technical support before you attempt to modify the server configuration.



Note: You must perform the procedure on each main server in the NFM-P system.



Note: In a redundant system, you must perform the procedure on the standby main server station first.

21.47.2 Steps

- 1 _____
Log in to the main server station as the nsp user.
- 2 _____
Open a console window.
- 3 _____
Navigate to the /opt/nsp/nfmp/server/nms/config directory.
- 4 _____
Open the nms-server.xml file using a plain-text editor.
- 5 _____
Locate the following section:

```
<SARSysIPAddrChange  
enabled="false"
```

```
ipRange="224.224.0.0"  
prefix="24" />
```

6 _____
Change `enabled="false".to enabled="true".`

7 _____
Save and close the `nms-server.xml` file.

8 _____
On a standalone main server, or the primary main server in a redundant system, enter the following:

```
bash$ /opt/nsp/nfmp/server/nms/bin/nmsserver.bash read_config ↵
```

The NFM-P puts the configuration change into effect.

9 _____
Close the console window.

END OF STEPS _____

21.48 How do I enable LSP on-demand resynchronization?

21.48.1 Purpose

By default, LSP on-demand resynchronization is disabled. When you enable LSP on-demand resynchronization, the NFM-P scheduled resynchronization is then disabled for some LSP objects. See “LSP on-demand resynchronization” in the *NSP NFM-P User Guide* for information about which LSP objects do not support on-demand resynchronization.



CAUTION

Service Disruption

Modifying the server configuration can have serious consequences including service disruption.

Contact technical support before you attempt to modify the server configuration.

i **Note:** You must perform the procedure on each main server in the NFM-P system.

i **Note:** In a redundant system, you must perform the procedure on the standby main server station first.

21.48.2 Steps

1 _____
Log in to the main server station as the `nsp` user.

How do I enable debug configuration file reloading on an NE for mirror services?

- 2 _____
Open a console window.
- 3 _____
Navigate to the `/opt/nsp/nfmp/server/nms/config` directory .
- 4 _____
Create a backup copy of the `nms-server.xml` file.
- 5 _____
Open the `nms-server.xml` file using a plain-text editor.
- 6 _____
Locate the following line:

```
lspOnDemand overrideEnabled="false" />
```
- 7 _____
Change `"false"` to `"true"`.
- 8 _____
Save and close the `nms-server.xml` file.
- 9 _____
On a standalone main server, or the primary main server in a redundant system, enter the following:

```
bash$ /opt/nsp/nfmp/server/nms/bin/nmsserver.bash read_config ↵
```

The NFM-P puts the configuration change into effect.
- 10 _____
Close the console window.

END OF STEPS _____

21.49 How do I enable debug configuration file reloading on an NE for mirror services?

21.49.1 Purpose

Ensure that the managed NEs reload the debug configuration file after an NE restart. This ensures that the mirror services in the managed network resume operation after a reboot or a CPM activity switch on the NE that hosts the mirror service. By default, debug configuration file reloading is disabled.



CAUTION

Service Disruption

*The procedure requires a restart of each main server, which is service-affecting.
Ensure that you perform the procedure only during a scheduled maintenance window.*



CAUTION

Service Disruption

*Modifying the server configuration can have serious consequences including service disruption.
Contact technical support before you attempt to modify the server configuration.*



Note: You must perform the procedure on each main server in the NFM-P system.



Note: In a redundant system, you must perform the procedure on the standby main server station first.

21.49.2 Steps

1

Log in to the main server station as the nsp user.

2

Open a console window.

3

Navigate to the /opt/nsp/nfmp/server/nms/config directory.

4

Open the nms-server.xml file using a plain-text editor.

5

Locate the section that begins with the following XML tag:

```
<serviceMirror
```

6

Specify the NE location of the debug configuration file. For example:

```
<serviceMirror  
  debugFilename="filename"  
  reloadDelay="delay"  
>
```

where

filename is the absolute file path of the debug log on the NE, for example, cf3:/ServiceMirror.dbg

delay is the time, in seconds, to wait before a reload request is sent

7

Save and close the nms-server.xml file.

8

Navigate to the /opt/nsp/nfmp/server/nms/bin directory.

9

Enter the following to restart the main server:

```
bash$ ./nmserver.bash force_restart ↵
```

The main server restarts.

10

Close the console window.

END OF STEPS

21.50 How do I configure throttle rates for subscriber trap events?

21.50.1 Purpose

Configure throttle rates for residential subscriber create and delete event traps on a 7750 SR. The throttle rate specifies the number of events that are received in a specified period before the NE stops sending individual traps.

21.50.2 Steps

1

On the equipment tree, right-click on the NE for which you want to configure trap event throttle rates and choose Properties. The Network Element (Edit) form opens.

2

Click Event Throttling. The ESM Trap Throttle form opens.

3

Disable the Default check box and configure the required parameters.

How do I configure the windowing trap delayer option for subscriber table resyncs?

4 _____
Click Execute. The Detailed Status/Error message field displays status information about the throttle rate change.

5 _____
Close the Network Element (Edit) form.

END OF STEPS _____

21.51 How do I configure the windowing trap delayer option for subscriber table resyncs?

21.51.1 Purpose

Configure the windowing trap delayer option to provide an enhanced method to resynchronize the subscriber table in the event that an NE drops a trap.

Configurable hold-off options prevent subscriber table resyncs for a minimum specified duration after a trap drop is received from an NE, and until a specified period has elapsed with no additional trap drops. Additionally, a maximum hold-off time is specified to prevent excessive periods during which the NFM-P is not synchronized with the NE. The windowing trap delayer configuration reduces the number of subscriber table resync events while attempting to maintain synchronization with the NE.

 **Note:** The windowing trap delayer option affects only tmnxTrapDropped traps associated with tmnxSubscriberCreated, tmnxSubscriberDeleted or tmnxSubscriberRenamed traps. When the windowing trap delayer option is disabled, tmnxTrapDropped traps are delayed using the default trap delay function.





CAUTION

Service Disruption

Modifying the server configuration can have serious consequences including service disruption.

Contact technical support before you attempt to modify the server configuration.

 **Note:** You must perform the procedure on each main server in the NFM-P system.

 **Note:** In a redundant system, you must perform the procedure on the standby main server station first.

21.51.2 Steps

1 _____
Log in to the main server station as the nsp user.

2 _____

Open a console window.

3 _____

Navigate to the `/opt/nsp/nfmp/server/nms/config` directory.

4 _____

Create a backup copy of the `nms-server.xml` file.

5 _____

Open the `nms-server.xml` file using a plain-text editor.

6 _____

Locate the section that begins with the following XML tag:

```
<snmp
```

7 _____

Add the following to the section:



Note: The `checkInterval` value must be less than the `windowLength` value, which must be less than the `maxHoldOff` value.

```
<windowingTrapDelayer  
enabled="true"  
checkInterval="interval"  
windowLength="duration"  
maxHoldOff="wait" />
```

where

interval is the minimum time, in seconds, during which subscriber table resynchronization is prevented; the range is 5 to 30, and the default is 10

duration is the time, in seconds, during which no additional trap drops can be received before subscriber table resyncs are allowed; the range is 5 to 60, and the default is 30

wait is the maximum hold-off time, in seconds, after which subscriber table resynchronization is allowed; the range is 5 to 1800; the default is 60

8 _____

Save and close the `nms-server.xml` file.

9 _____

On a standalone main server, or the primary main server in a redundant system, enter the following:

```
bash$ /opt/nsp/nfmp/server/nms/bin/nmserver.bash read_config ↵
```

The NFM-P puts the configuration change into effect.

10

Close the console window.

END OF STEPS

21.52 How do I create a default SNMPv2 OmniSwitch user?



CAUTION

Service Disruption

Modifying the server configuration can have serious consequences including service disruption. Contact technical support before you attempt to modify the server configuration.



Note: You must perform the procedure on each main server in the NFM-P system.



Note: In a redundant system, you must perform the procedure on the standby main server station first.

21.52.1 Steps

1

Log in to the main server station as the nsp user.

2

Open a console window.

3

Navigate to the `/opt/nsp/nfmp/server/nms/config` directory.

4

Create a backup copy of the `nms-server.xml` file.

5

Open the `nms-server.xml` file using a plain-text editor.

6

Locate the section that begins with following XML tag:

```
<snmp
```

7

Insert the following before the section end, which is marked by a `</>` tag:

```
snmpV2UserName="username"
```

where *username* is a user name that is configured on the OmniSwitch

i **Note:** If the inserted text and end tag are on the same line, you must include a space between the text and the end tag.

The section now reads as follows:

```
<snmp
ip="IPv4_address"
port="nnnnn"
ipv6="IPv6_address"
msgMaxSize="nnnn"
natEnabled="value"
trapLogId="nn"
snmpV2UserName="username" >
```

8

Save and close the `nms-server.xml` file.

9

On a standalone main server, or the primary main server in a redundant system, enter the following:

```
bash$ /opt/nsp/nfmp/server/nms/bin/nmserver.bash read_config ↵
```

The NFM-P puts the configuration change into effect.

10

Close the console window.

END OF STEPS

Setting NFM-P OLC states

21.53 What is an OLC state?

21.53.1 Description

Performing a maintenance operation on an NE can generate a considerable number of NFM-P alarms that are not of interest to an operator. You can configure the OLC state of a service or equipment object to specify whether the object is in service or in maintenance mode. During a subsequent maintenance operation, you can filter alarms using the OLC state as a criterion in order to display only the alarms of interest.

 **Note:** The NFM-P raises alarms against service and equipment objects regardless of the OLC state, which is not deployed to NEs.

You can set the OLC state on the following equipment and service objects:

- network elements
- power supply trays
- card slots
- daughter cards
- ports
- LAGs
- composite services
- services
- sites
- SAPs

 **Note:** A shelf OLC state is inherited from the parent NE, and is not configurable.

On equipment and service properties forms, you can configure the NFM-P to change the OLC state of an object after a specified time, depending on the current OLC state. In a device discovery rule, you can configure the default OLC state for NEs, and can specify that the current OLC state reverts when the NE discovery is complete. You can also specify that the NFM-P raise an informational alarm about an object OLC state reverting to the opposite state. See the *NSP NFM-P User Guide* for information about device discovery rules and OLC states.

21.53.2 Setting the OLC state



CAUTION

Service Disruption

Changing the OLC state of an object also changes the OLC state of child objects that are not locked in maintenance mode, and may affect NFM-P system performance.

Ensure that you change the OLC state of an object that has many child objects only during a period of low NFM-P activity, such as during a scheduled maintenance period.

 **Note:** An OLC state change operation may take several minutes to complete, depending on the number of objects that the state change affects.

A child object inherits the OLC state of the parent object. However, you can lock the OLC state of a child object in maintenance mode to prevent the inheritance in the event that the parent OLC state changes. Locking the OLC state of an object also locks the OLC state of each child object.

You can specify a global default OLC state for discovered services; see [21.11 “How do I set the NFM-P system preferences?”](#) (p. 526).

During a shutdown or turn-up operation, the OLC state of the parent object overwrites the OLC state of each child object, unless the OLC state of a child object is locked in maintenance mode. The NFM-P Task Manager logs the OLC state change of an object, but does not log the OLC state changes of the child objects.

i **Note:** When an OLC state change affects a large number of objects, alarms raised against affected objects before the state change is propagated show the previous OLC state. Also, if an operator shuts down an equipment or service object via CLI, the associated NE trap handling for the child objects requires additional processing which can cause the same propagation delay and OLC state misrepresentation in alarms.

21.53.3 Functional description

When the OLC state of an NE is set to maintenance mode, all child objects such as access interfaces, card slots, daughter cards, and ports are set to maintenance mode, as is each service site on the NE.

When the OLC state of a composite service or service is set to the maintenance mode, the following child objects are affected:

- service sites
- L2 and L3 SAPs
- SDP bindings

When the OLC state of a composite service or services changes to in service, the OLC states of the associated sites and SAPs do not change if the host equipment objects are in maintenance mode.

The OLC state of an object must be in service before you can change the OLC state of a child object. You can change the OLC state of a parent object regardless of the OLC state of a child object, but if a child object has more than one parent object and the OLC state of one parent is set to maintenance, the child object is set to maintenance. You cannot change the OLC state of an object when a parent OLC state is set to maintenance.

You can configure the default OLC state for objects that become administratively down from the OLC tab of the System Preferences form; see [21.11 “How do I set the NFM-P system preferences?”](#) (p. 526).

You must add the OLC state property to manually created service templates, as described in [21.60 “How do I add the OLC state property to a manually created service template?”](#) (p. 593) .

21.54 How do I display equipment or service OLC states?

21.54.1 Steps

- 1 _____
Choose Administration→OLC from the NFM-P main menu. The OLC form opens.
- 2 _____
Choose a service or network object from the drop-down menu and click Search. A list of objects is displayed.
- 3 _____
View the Current OLC State and Lock OLC State values.
- 4 _____
Close the OLC form.

END OF STEPS _____

21.55 How do I display the OLC state change schedules?

21.55.1 Steps

- 1 _____
Choose Administration→OLC from the NFM-P main menu. The OLC form opens.
- 2 _____
Click on the Schedules tab. A list of scheduled OLC state changes is displayed.
- 3 _____
View the following information:
 - object ID and name
 - current OLC state
 - OLC state to which the object reverts at the scheduled time
 - time when the OLC state changes
- 4 _____
As required, select an entry and click Properties to view more information.

5 _____
Close the open forms.

END OF STEPS _____

21.56 How do I change the OLC state of one or more objects?



CAUTION

Service Disruption

Changing the OLC state of an object also changes the OLC state of child objects that are not locked in maintenance mode, and may affect NFM-P system performance.

Ensure that you change the OLC state of an object that has many child objects only during a period of low NFM-P activity, such as during a scheduled maintenance period.

i **Note:** You can change the OLC state of multiple services at once only if the services are of the same type.

i **Note:** An OLC state change operation may take several minutes to complete, depending on the number of objects that the state change affects.

21.56.1 Steps

1 _____
Perform one of the following.

- a. Use the OLC form.
 1. Choose Administration→OLC from the NFM-P main menu. The OLC form opens.
 2. Choose a service or network object type from the drop-down menu and click Search. A list of objects is displayed.
 3. Select one or more entries and click OLC State→Maintenance or OLC State→In Service.
- b. Use an object properties form.
 1. Open the object properties form of one object, or the multi-instance properties form of multiple objects. A properties form opens.
 2. Configure the Current OLC State parameter.

The OLC state of each selected object changes.

2 _____
Save the changes and close the open forms.

END OF STEPS _____



21.57 How do I lock the OLC state?

21.57.1 Purpose

You can lock the OLC state of a child object that is in maintenance mode to prevent the OLC state from changing in the event that the parent object OLC state changes to In Service. Locking the OLC state of an object disables any associated scheduled OLC state change. Also, when the OLC state of an object is locked, you cannot configure the Revert OLC State parameter of the object.

 **Note:** You can lock the OLC state of multiple objects at once.

21.57.2 Steps

- 1 _____
Choose Administration→OLC from the NFM-P main menu. The OLC form opens.
- 2 _____
Choose a service or network object type from the drop-down menu and click Search. A list of objects is displayed.
- 3 _____
Select one or more entries and click Properties. The object or multi-instance properties form opens.
- 4 _____
Configure the Lock OLC State parameter.
 **Note:** You can lock the OLC state only when the Current OLC State parameter is set to Maintenance.
 **Note:** If all selected objects have an OLC state of Maintenance and one or more objects is locked in maintenance mode, the Lock OLC State parameter is selected and dimmed, but is configurable.
- 5 _____
Save the changes and close the OLC form.

END OF STEPS _____

21.58 How do I schedule an OLC state change?



CAUTION

Service Disruption

Changing the OLC state of an object also changes the OLC state of child objects that are not locked in maintenance mode, and may affect NFM-P system performance.

Ensure that you schedule the OLC state change of an object that has many child objects to occur during a period of low NFM-P activity, such as during a scheduled maintenance period.

21.58.1 Steps

- 1 _____
Choose Administration→OLC from the NFM-P main menu. The OLC form opens.
- 2 _____
Choose a service or network object type from the drop-down menu and click Search. A list of objects is displayed.
- 3 _____
Select one or more entries and click Properties. The object properties or multi-instance properties form opens.
- 4 _____
Configure the Revert OLC State parameter. If you set the parameter to Custom, use the calendar tool to specify a time and date at which the OLC state is to change.

i **Note:** If multiple objects are selected, a schedule is created for each object. Also, the OLC State Will Revert To and Revert OLC Time indicators are not shown on multi-instance properties forms; you must open the properties form for one object to view the indicators.
- 5 _____
Save the changes and close the OLC form.

END OF STEPS _____

21.59 How do I change the OLC state assigned to one or more alarms?

21.59.1 Steps

- 1 _____
If required, create an alarm filter.
 1. Click on the filter icon in the Alarm Window. A filter form opens.

-
2. Choose Assigned OLC State from the Attribute drop-down menu.
 3. Configure the filter, as required. See the *NSP NFM-P User Guide* for information about creating alarm filters.

2

Select one or more alarms in the alarm list.

3

Right-click on the selected alarms and choose Assign OLC State. The OLC State Assignment form opens.

4

Configure the Assigned OLC State parameter.

5

Save the changes and close the OLC State Assignment form.

END OF STEPS

21.60 How do I add the OLC state property to a manually created service template?

21.60.1 Purpose

You cannot configure the OLC state property of a service object during object creation. The OLC state property is automatically included in an NFM-P-created service template, but not in a manually created service template.

21.60.2 Steps

1

Open the GUI builder, as described in the *NSP NFM-P Scripts and Templates Developer Guide*.

2

Create a combo box component and enter `olcState` as the Name attribute value.

3

Enter the following as the List attribute values:

- `inService`
- `maintenance`

4

Enter one of the following as the Default attribute value:

How do I add the OLC state property to a manually created service template?

- inService
- maintenance

5

Save the changes and close the open forms.

END OF STEPS

NFM-P platform modification and replacement

21.61 What is platform modification?

21.61.1 Platform modification



CAUTION

Service Disruption

To avoid a network management outage, it is strongly recommended that you contact technical support before you attempt to modify an NFM-P component platform.

An NFM-P component may require reconfiguration or another type of action in response to a change in the available platform resources.

After you reconfigure the platform of a main server, main database, or auxiliary server station, you must ensure that the station reboots successfully before you restart the NFM-P software on the station.

Basic platform modifications include:

- Number of CPUs
- Amount of RAM
- NIC type
- OS patch or upgrade
- IP-address or hostname change; see the following, as required:
 - [21.64 “How do I change the IP address or hostname of an NFM-P component?”](#) (p. 600)
 - [20.12 “How do I change the auxiliary database external IP addresses?”](#) (p. 471)

Some components require specific configuration as part of a platform modification; see the following, as required:

- any component, before increasing LVM disk space—[21.62 “How do I test NFM-P disk performance?”](#) (p. 596)
- main database, after an OS patch or upgrade—[21.63 “How do I relink the Oracle executable files?”](#) (p. 599)

21.61.2 Platform replacement

In the event that an NFM-P component station fails and cannot be recovered, you must re-install the component on a replacement station that has the same platform specifications as the original station. If you want to use a station with different specifications, you must contact technical support to develop an approved hardware migration strategy.

After you replace the platform of an NFM-P component, you must ensure that the newly installed component on the replacement station retains all functions and customized properties of the original component.

Some components, such as main servers, may have custom settings in configuration files. In order to restore the original server functions, you must restore the custom settings. Each NFM-P

procedure that describes modifying parameters in configuration files includes a step to back up the current configuration to a secure location. After a replacement component is installed, and before the component initializes, you must use the backup files to replace the newly installed files. Contact technical support for more information.

Multi-vendor driver restoration

MV driver files are installed on a main server after the main server installation. If your NFM-P system manages devices using MV drivers, and the main server fails, you must re-install the drivers on the replacement main server.

 **Note:** Until the MV drivers are installed on the new main server, any devices managed using the drivers are in the Suspended state, and the driver status indicates that the driver file is absent from the main server file system.

See the *NSP NFM-P User Guide* for driver installation information.

21.62 How do I test NFM-P disk performance?

21.62.1 Purpose

Perform this procedure to check the disk performance on an NFM-P component station.

The disk performance of an NFM-P component affects overall system performance, and must meet or exceed the minimum specifications in the response to the NFM-P Platform Sizing Request for your system. See the *NSP NFM-P Release Description* for information about submitting a Platform Sizing Request.

Also, before you add capacity to a disk or partition on an NFM-P component, for example, using LVM, you must ensure that the disk throughput and latency values remain within tolerance, which is defined as being within 10% of the current values.



CAUTION

Service Disruption

Checking NFM-P disk performance requires a shutdown of one or more NFM-P components, which is service-affecting.

Perform the procedure only during a scheduled maintenance period.

21.62.2 Steps

1

Perform one of the following, depending on the type of component for which you need to check performance:

- a. Shut down a main server.
 1. Log in to the main server station as the nsp user.
 2. Open a console window.

3. Navigate to the `/opt/nsp/nfmp/server/nms/bin` directory.

4. Enter the following:

```
bash$ ./nmserver.bash stop ↵
```

5. Enter the following to display the server status:

```
bash$ ./nmserver.bash appserver_status ↵
```

The server status is displayed; the server is fully stopped if the status is the following:

```
Application Server is stopped
```

If the server is not fully stopped, wait five minutes and then repeat this step. Do not perform the next step until the server is fully stopped.

b. Shut down an auxiliary server.

1. Log in to the auxiliary server station as the nsp user.

2. Open a console window.

3. Navigate to the `/opt/nsp/nfmp/auxserver/nms/bin` directory.

4. Enter the following:

```
bash$ ./auxnmserver.bash auxstop ↵
```

5. Enter the following to display the auxiliary server status:

```
bash$ ./auxnmserver.bash auxappserver_status ↵
```

The command returns a status message.

6. The server is fully stopped when the following is displayed:

```
Auxiliary Server is stopped
```

If the server is not fully stopped, wait five minutes and then repeat this step. Do not perform the next step until the server is stopped.

c. Shut down a main database.

1. Log in to the main database station as the root user.

2. Open a console window.

3. Enter the following to stop the Oracle proxy:

```
# systemctl stop nfmp-oracle-proxy.service ↵
```

4. Enter the following to stop the main database:

```
# systemctl stop nfmp-main-db.service ↵
```

d. Shut down an auxiliary database; perform [20.3 “How do I stop an auxiliary database cluster?” \(p. 453\)](#).

2

If you are performing the test on a main or auxiliary server station, enter the following to switch to the root user:

```
bash$ su - ↵
```

3

Perform one of the following.

- a. On a main server station, enter the following:

```
# /opt/nsp/nfmp/server/nms/bin/unsupported/IOTest/NSP_IOTest.pl -d  
target ↵
```

where *target* is the disk partition to test

- b. On an auxiliary server station, enter the following:

```
# /opt/nsp/nfmp/auxserver/nms/bin/unsupported/IOTest/NSP_IOTest.pl  
-d target ↵
```

where *target* is the disk partition to test

- c. On a main database station, enter the following:

```
# /opt/nsp/nfmp/db/install/tools/unsupported/IOTest/NSP_IOTest.pl -d  
target ↵
```

where *target* is the disk partition to test

4

Record the utility output.

5

If you are performing the test as a pre-upgrade task specified in the *NSP Installation and Upgrade Guide*, or as a general performance check, perform the following steps.

1. Compare the following recorded values with the values specified for your system:
 - main server, main database, or auxiliary server—Read, Write, and Latency
 - NSP auxiliary database—Read, Write, Rewrite, and %IO Wait
2. If the values do not meet the minimum specifications, contact the NFM-P Platform Team through your account representative.
3. Go to [Step 7](#).

6

If you are adding capacity to a disk or partition, perform the following steps.

1. Add the required capacity to the disk or partition.
2. Repeat [Step 3](#) and [Step 4](#) as required.
3. Compare the following values from before and after the capacity increase:
 - main server, main database, or auxiliary server—Read, Write, and Latency
 - auxiliary database—Read, Write, Rewrite, and %IO Wait
4. If the values differ by more than 10%, contact the NFM-P Platform Team through your account representative.

-
- 7 _____
Close the console windows, as required.

END OF STEPS _____

21.63 How do I relink the Oracle executable files?

21.63.1 Purpose

Perform this procedure to relink the Oracle executable files on a main database station after you apply an OS patch, or after an OS upgrade.



CAUTION

Service Disruption

This procedure requires a restart of the main database, which is service-affecting.

You must perform the procedure only during a scheduled maintenance period.



Note: You require root user privileges on the main database station.

21.63.2 Steps

- 1 _____
Log in as the root user on the main database station.
- 2 _____
Open a console window.
- 3 _____
Enter the following:

```
# chmod 755 /usr/bin/make ↵
```
- 4 _____
Enter the following:

```
# /opt/nsp/nfmp/db/install/config/samdb/relinkOracle.sh ↵
```

The script relinks the Oracle executable files.
- 5 _____
When the script execution is complete, enter the following to reboot the database station:

```
# systemctl reboot ↵
```

The station reboots, and the main database initializes.

6

After the reboot, enter the following:

```
# chmod 750 /usr/bin/make ↵
```

7

Close the console window.

END OF STEPS

21.64 How do I change the IP address or hostname of an NFM-P component?

21.64.1 Purpose

Changing the IP address or hostname of one or more NFM-P components in a standalone or redundant system may be required, for example, when the management network topology changes.

The requirements of such an operation depend on the management network topology and other considerations, so must be co-ordinated and performed only under the guidance of technical support.



CAUTION

Service Disruption

Changing an IP address or hostname in an NFM-P system is a complex operation that requires careful planning and organization, and depending on the type of change required, may involve a brief network management outage.

Do not attempt to modify the network configuration of an NFM-P component without assistance from technical support.

21.64.2 Steps

1

Collect the following information:

- hostname of each main server, main database, auxiliary server, and client delegate server station
- current IP address of each interface that is used by the main servers, main databases, auxiliary servers, NSP auxiliary databases, and client delegate servers
- hostname and IP address of each NSP component that the NFM-P communicates with
- configuration information for mechanisms in the management network that affect addressing, such as NAT
- new IP addresses and hostnames of the components

How do I change the IP address or hostname of an NFM-P component?

2

Contact technical support to schedule a maintenance period for the network configuration change.

END OF STEPS

NFM-P maintenance

21.65 What is NFM-P system maintenance?

21.65.1 Introduction

The implementation of a regular maintenance schedule is recommended in order to:

- prevent downtime caused by software, platform, or network failure
- enable maximum system performance

NFM-P system maintenance begins with the establishment of base measures against which to evaluate the system functionality and correct any performance or connectivity issues.

NFM-P OLC states

You can put NEs in maintenance mode using OLC states, as described in [“Setting NFM-P OLC states”](#) (p. 587).

21.65.2 NFM-P base measures

Maintenance base measures can be used by NOC operations or engineering staff who are responsible for maintenance issues to evaluate the activity and performance of network components, for example, client GUI response times when listing equipment.

The data from a series of base measures can be used, over time, to track performance trends. For example, if there are reports that client GUI response times for listing equipment degrades over time, you can use the base measures to determine how much performance has degraded. The procedures in this guide can help narrow the search for the cause of performance degradation.

It is recommended to do the following:

- Determine the types of base measures required for your network.
- Record base-measure data.
- Regularly collect system information and compare the information with the base measure data.

This section provides base measure information for:

- platform—to ensure system sizes are tracked
- performance and scalability—to categorize system limitations as a baseline against NMS response times
- inventory counts—to generate inventory lists for storage and post-processing
- reachability—to ensure that customer services are available

21.65.3 Establishing base measures

Base measures can be affected by issues that are beyond the scope of this guide, including:

- network topology design
- NOC or operations area LAN design

The NFM-P service test manager (STM) provides the ability to group OAM diagnostic tests into test suites that you can run as scheduled tasks. You can customize a test suite to your network topology

and execute the test suite to establish baseline performance information. You can retain the test suite, modify it to accommodate network topology changes, and execute the test suite to establish new base measures as required. Scheduled execution of the test suite and regular review of the results may reveal deviations from the baseline. See the *NSP NFM-P User Guide* for information about using the STM and creating scheduled tasks.

21.65.4 Platform base measures

You can use platform base measures to:

- record the details of the platform configuration
- track network-specific growth to provide a delta for performance measures, for example, how long it takes to list 1000 ports on the current station compared to 10 000 ports on the same station, or on a smaller or larger station

Table 21-4 Platform base data

Component	Platform information
Main server 1	RAM: CPU (quantity, type, speed): OS version and patch level:
Main database 1	RAM: CPU (quantity, type, speed): OS version and patch level:
Main server 2	RAM: CPU (quantity, type, speed): OS version and patch level: Swap space: Disk slices:
Main database 2	RAM: CPU (quantity, type, speed): OS version and patch level: Swap space: Database disk file systems: Disk slice sizes:
Auxiliary server 1	RAM: CPU (quantity, type, speed): OS version and patch level: Swap space: Disk slice sizes:
Auxiliary server 2	RAM: CPU (quantity, type, speed): OS version and patch level: Swap space: Disk slice sizes:

Table 21-4 Platform base data (continued)

Component	Platform information
Auxiliary server 1	RAM: CPU (quantity, type, speed): OS version and patch level: Swap space: Disk slice sizes:
Auxiliary server 2	RAM: CPU (quantity, type, speed): OS version and patch level: Swap space: Disk slice sizes:
Client delegate server	OS type, version, patch level: RAM: CPU: Disk space: Monitor: Graphics card:
Single-user GUI client	OS type, version, patch level: RAM: CPU: Disk space: Monitor: Graphics card:
Single-user GUI client	RAM: CPU: OS type, version, patch level: Disk space: Monitor: Graphics card:

21.65.5 Inventory base measures

You can use inventory base measures to:

- create lists of network objects for future processing
- track network-specific growth to provide a delta for any performance measures, for example, how long it takes 5 versus 15 client GUIs to list 1000 ports

Use the following sequence to create inventory base measures, for example, for access ports. You can modify the sequence to create additional inventory base measures for other objects.

1. Determine the type of object data for which you need to create inventory records, for example, access ports.
2. List the ports of all managed network devices using the client GUI manage equipment window or create an XML API request to generate the list.
3. Format the inventory for future processing, based on your inventory processing requirements.

-
4. Generate the inventory data, using the same listing and filtering criteria, on a weekly or monthly basis, as necessary to track changes to the network.

When new devices are added to the network on a regular basis, increase the inventory frequency.

5. Use the generated list to record the current inventory of network objects and as a baseline measure of performance.

For example, baseline the time required to generate a client GUI list of 1000 access ports.

When an access port list is later generated, record the time required to generate the list using 2000 ports. Ideally, it takes twice as long to list twice as many ports; if the ratio of listing time to number of ports is highly nonlinear, there may be scalability issues that require investigation.

21.65.6 Performance and scalability base measures

You can use the following performance and scalability base measures to:

- record the system limit numbers and compare to the measurement data collected in your network
- track network-specific growth to provide a delta for any performance measures on similarly-sized platforms, for example, how long it takes to discover 10 new devices versus 20 new devices
- quantify user perceptions of performance

Table 21-5 Scalability base measures

Type of base measure	System limits	Expected response time	Network base measure response time	Additional information
Total devices managed	See the appropriate <i>NSP NFM-P Release Description</i> and <i>NSP Planning Guide</i> for information about release-specific system limits.	The client GUI is operational XX seconds after launching.		The time to open icons in the Equipment navigation tree increases depending on the number of configured MDAs.
Total services		<ul style="list-style-type: none"> XML API configuration of 300 VLL services in X min XML API configuration of 100 VPLS services with 3 sites and one SAP in 5 min 		The complexity of the service configuration affects response time. For example, adding additional SAPs to a VPLS increases provisioning time.
Outstanding alarms		The client GUI is able to retrieve and display XX 000 alarms in the dynamic alarm list during startup.		—
Client GUIs for each server		—		Open a configuration form using the client GUI in X amount of time. Measure X against a constant platform size over time
Device discovery		Discover one additional device with an IP address in the X.X.X.1 to 255 range in less than 1 min.		—

21.65.7 Performance base measures

For networks, commonly available tools such as ping, which measures round trip time using ICMP, can be used to determine quantities such as packet loss and round trip delay. See the ping command information in this guide, and the *NSP Troubleshooting Guide*, for more information about performing the commands.

- Packet loss is defined as the fraction of packets sent from a measurement agent to a test point for which the measurement agent does not receive an acknowledgement from the test point. Acknowledgements that do not arrive within a predefined round trip delay at the measurement agent are considered lost.
- Round trip delay is defined as the interval between the time a measurement agent sends a packet to a test point and the time it receives acknowledgement that the packet was received by the test point.

You can baseline the packet loss results and round trip delay times for specific NMS LAN and network scenarios. Record those results for future baselines against regularly run packet loss and round trip delay tests.

21.65.8 Reachability base measures

System reachability is important in business-critical systems. Service reachability components are:

- Can the customer reach the service? (reachability)
- If so, is the service available for customer use? (service availability)
- If not, how frequently and how long do service outages last? (service outage duration)

The types of measures and baselines necessary to ensure reachability and availability are network-dependent, and vary depending on the topology of the network, the networking technologies used to move data, and the types of equipment used.

NE reachability

A test point is reachable from a testing measurement agent when the agent can send packets to the test point and receive a response from the test point that the packet was received. The ping test and the OAM diagnostics using the NFM-P or device CLI can test reachability. Record the test results to create a measurement baseline.

These tests can be performed when you troubleshoot a customer service, or when you perform SLA tests before you enable a customer service.

Service availability

The network between a measurement agent and a test point is considered available at a given time when the measured packet loss rate and the round trip delays are both below predefined thresholds. The threshold values are dependent on network topology. The ping test and the OAM diagnostics using the NFM-P or CLI to a device can test service availability. Record the test results to create a measurement baseline.

Service outage duration

The duration of an outage is defined as the difference between the time a service becomes unavailable and the time it is restored. Time between outages is defined as the difference between the start times of two consecutive outages. Troubleshooters that resolve customer problems, or the data generated to resolve SLAs, can provide the baseline metrics to measure outages, and the time between outages. Record the information to create a measurement baseline.

21.66 How do I back up the main database?

21.66.1 Overview

It is strongly recommended that you frequently back up the main database to prevent network data loss in the event of a failure. Other reasons for performing a database backup include the following:

- To move a database from one station to another
- To set aside a clean copy of the database before performing a system upgrade
- As a preventive measure before making a major change to the network

You can use the NFM-P client GUI or a CLI script to perform an immediate backup, and can use the GUI to schedule regular backups. See [Chapter 22, "Classic management database administration"](#) for information.

It is recommended that you perform a daily backup of the file system on each NFM-P station to enable the component restoration in the event of a catastrophic failure.

21.67 How do I collect and store NFM-P log and configuration files?

21.67.1 Overview

When an NFM-P system runs for long periods with significant activity, the number of generated log files can consume a large amount of disk space. You must ensure that the contents of the NFM-P log directories are backed up on a regular basis to maintain a system activity record and to save disk space. It is also recommended that you back up the NFM-P configuration files



Note: You must contact technical support to modify the NFM-P log storage parameters.

Daily maintenance

21.68 How do I check the main database performance?

21.68.1 Steps

Monitor device synchronization to confirm that the main database information is maintaining synchronization with the NE configuration information.

1

Check for deployment failures. Deployment failures indicate that communication with a managed NE is failing.

1. Choose Administration→NE Maintenance→Deployment from the NFM-P main menu. The Deployment form opens.
2. Click Search to display the latest information.
When no failed deployments are listed, deployment problems are not causing a synchronization issue.
3. If deployments are listed, view the state of a deployment in the State column. The possible deployment states include:
 - Canceled
 - Deployed
 - Failed (Configuration). Failure occurred because the configuration could not be applied to the specified objects.
 - Failed (Internal Error). Failure occurred due to general error conditions. The state is intended for all other possible errors.
 - Failed (Partial). Failure occurred at deployment and some of the configuration may have been sent to the network.
 - Failed (Resource Unavailable). Failure occurred because one of the resources required to apply the configuration is not in the main database.
 - Not Deployed
 - Pending
 - Postponed
4. Identify the source of the deployment problem. For example, for a Failed configuration state, ensure the configuration was performed correctly on the client GUI.

2

If you determine that there is a deployment problem and the problem is unrelated to the NFM-P or device configuration, use your company IT policies to check the LAN for connectivity and transmission problems, such as collisions and CRC errors.

END OF STEPS

21.69 How do I back up the NFM-P log and configuration files?

21.69.1 Process

Perform this procedure to save a copy of the NFM-P installation log and configuration files for later analysis in the event of a failure.

i **Note:** During a system restart, NFM-P log files are backed up to directories that are named using a timestamp. A component that runs for a long time can generate multiple log files. Before you restart an NFM-P component, ensure that there is sufficient disk space to store the backed-up log files.

21.69.2 Steps

1

Copy the following files from the /tmp directory on a RHEL station, or from the *installation_directory*\client directory on a Windows client station:

- NFM-P_*component*_stderr.txt
- NFM-P_*component*_stdout.txt.

where *component* is the NFM-P component type, for example, Main_Server, Main_Database, or Client

2

Copy the following file from each GUI client station; rename each file to indicate the client station from which it is copied:

- *installation_directory*/nms/config/nms-client.xml

3

Copy the following file from each main database station:

- /opt/nsp/nfmp/db/install/config/dbconfig.properties

4

Copy the following files from each main server station.

- /opt/nsp/nfmp/server/nms/config/nms-server.xml
- all log files in the /opt/nsp/nfmp/server/nms/log/server directory
- all log files in the /opt/nsp/nfmp/server/nms/log/jmsserver directory

When an NFM-P log file reaches a predetermined size, the NFM-P closes, compresses, and renames the file by including a sequence number and a timestamp. The following is an example of the filename format:

EmsServer.#.timestamp.log

where

is a sequence number; the sequence begins at 0

timestamp is the log closure time, in the following format: YYYY-MM-DD_hh-mm-ss

5 _____

Copy the following file from each auxiliary server station:

- /opt/nsp/nfmp/auxserver/nms/config/nms-auxserver.xml

6 _____

Transfer the files to a secure location that is not in the network management domain.

END OF STEPS _____

Weekly maintenance

21.70 How do I back up and restore NE configuration files?

21.70.1 Description

The NFM-P stores NE configuration files on a main server file system. The following procedures describe how to create a backup archive of all NE configuration files on a main server, and how to restore an NE backup archive, for example, after a main server disk failure.

21.70.2 Device backups

The NFM-P backs up device files that include the following, depending on the device type and configuration:

i **Note:** NE backup is not supported for NEs in model-driven mode. NEs in model-driven mode must be excluded from backup/restore policies.

- boot options file, or BOF
- primary-config file specified in the BOF
- port index file
- SAP index file
- LI configuration file
- NE license file
- debug file
- security certificate files

An NFM-P user requires the following to schedule device backups:

- an assigned Administrator scope of command role, or a scope of command role with write access to the mediation package
- FTP access on the device
- devices that have the BOF persist parameter enabled

21.71 How do I check the NE scheduled backup status?

21.71.1 Steps

1

Choose Administration→NE Maintenance→Backup/Restore from the NFM-P main menu. The Backup/Restore form opens.

2

Click on the Backup/Restore Status tab. The managed NEs are listed and backup and restore status information is displayed.

-
- 3 _____
Select an NE and click Properties. The NE Backup/Restore Status form opens.
 - 4 _____
View the information in the Backup Status panel. A Backup State other than Successful may indicate a communication problem or a backup policy configuration error.
 - 5 _____
Ensure that the NE configuration file and the associated index file are saved on the NE and available for backup. Click on the Configuration Saves tab, and ensure that the Config Save State indicator reads Success.
See the appropriate device documentation for more information.
 - 6 _____
Click on the Backups tab to view a list of backup operations that are currently in progress. A backup operation disappears from the list after it completes.
 - 7 _____
Click on the Faults tab to view additional troubleshooting information.
 - 8 _____
Close the NE Backup/Restore Status form.
 - 9 _____
Use the information obtained from the NE Backup/Restore Status form to check the backup policy configuration, if required. Click on the Backup/Restore Policy tab.
 - 10 _____
Select the backup policy for the NE and click Properties. The Backup Policy (Edit) form opens.
 - 11 _____
Ensure that the policy is assigned to the NE.
 1. Click on the Backup/Restore Policy Assignment tab. The Backup Policy - Filter form opens.
 2. Configure the policy filter criteria and click OK. The Backup Policy - Filter form closes.
 3. Move the NE to the Assigned Sites list if it is not there by selecting the site from the Unassigned Sites list and clicking on the right-arrow.
 4. Save your changes and close the form.
 - 12 _____
Click on the General tab on the Backup Policy (Edit) form.

13 _____
Select the Enable Backup check box.

14 _____
Modify the other parameters, if required.

15 _____
Save your changes and close the form.

END OF STEPS _____

21.72 How do I back up the NE configuration files?

i **Note:** Depending on the size and number of NE configuration files, a backup operation may take considerable time.

21.72.1 Steps

1 _____
Log in to the standalone main server station, or the primary main server station in a redundant deployment, as the nsp user.

2 _____
Open a console window.

3 _____
Enter the following:

```
bash$ mkdir /opt/nsp/nfmp/nebackup/backup ↵
```

4 _____
Enter the following:

i **Note:** If you intend to copy and paste the command from this step into the console window, ensure that you remove the line breaks from the command text before you paste the text.

```
bash$ tar cf - --exclude='backup' /opt/nsp/nfmp/nebackup/ | gzip -c  
>/opt/nsp/nfmp/nebackup/backup/nebackup_`date +%Y-%m-%d-%H-%M`.tgz ↵
```

A compressed archive file named YYYY-MM-DD-hh-mm.tgz is created in the /opt/nsp/nfmp/nebackup/backup directory, where YYYY-MM-DD-hh-mm is the file creation time.

5

When the backup operation is complete, copy the file to a secure station that is not part of the NFM-P system. If you lack access to such a station, and the NFM-P system is redundant, copy the file to the standby main server station.

6

Close the console window.

END OF STEPS

21.73 How do I restore the NE configuration files?

i **Note:** Depending on the size and number of NE configuration files, a restore operation may take considerable time.

21.73.1 Steps

1

Log in to the standalone or primary main server station as the nsp user.

2

Open a console window.

3

Copy the appropriate NE configuration archive file to the /opt/nsp/nfmp/nebackup/backup directory.



Note: An NE configuration archive file is named using the file creation time, and has the following format:
YYYY-MM-DD-hh-mm.tgz

4

Enter the following:



Note: If you intend to copy and paste the command from this step into the console window, ensure that you remove the line break from the command text before you paste the text.

```
bash$ gzip -cd /opt/nsp/nfmp/nebackup/backup/nebackup_  
YYYY-MM-DD-hh-mm.tgz | tar xf - -C / ↵
```

where YYYY-MM-DD-hh-mm.tgz is the name of the backup file

The NE configuration files are extracted to the /opt/nsp/nfmp/nebackup directory.

5

When the restore operation is complete, close the console window.

END OF STEPS

21.74 Why collect device hardware inventory data?

21.74.1 Overview

You can collect device hardware inventory data to:

- create a list of managed device objects, for example, access ports that are available as SAPs
- save for future processing and inventory tracking
- compare the current and historical lists to identify trends and capacity changes
- record the time required to gather inventory data as a base measure

See the inventory chapter in the *NSP NFM-P User Guide* for more information about generating specific types of inventory reports.

21.75 How do I collect port inventory data for a specific managed device?

21.75.1 Process

For most inventory lists you can:

- generate an inventory of the listed data
- reorganize the information from most important to least important
- remove columns of data
- sort rows in ascending or descending order

21.75.2 Steps

1

Choose Manage→Equipment→Equipment from the NFM-P main menu. The Manage Equipment form opens.

2

Choose a Network Element (Network) and click Search. The list form displays the results of the inventory search.

3

Choose an NE from the list and click Properties. The Network Element (Edit) form opens.

4

Click on the Inventory tab and choose Port (Physical Equipment). The list form displays the results of the inventory search for the selected device.

5

Generate a list based on the inventory collection or comparison that you plan to make. For example, to compare weekly lists of access ports, generate a filter to list only access ports.

6

Record the amount of time required to generate the inventory list for future base measure comparisons.

7

To show or hide columns of access port information:

1. Right-click on a column heading and choose Column Display.
2. Select Administrative State in the Displayed on Table column and click the left arrow to move the Administrative State to the Available for Table column.
3. Click Apply. The Administrative State column of data is removed from the access port list.

8

To save the list of access ports:

1. Right-click on a column heading and choose Save To File. The Save form opens.
2. Enter a filename; for example, *access_device123_dateoflistgeneration*.
3. Click Files of Type to specify the file type.
4. Browse to choose a location in which to save the file.
5. Click Save. The file is saved to the specified location with the appropriate file extension.

9

To save the table preferences for future use:

1. Right-click on a column heading and choose Save Table Preferences.
2. Click OK to confirm.

The table preferences for the list form and user are saved. For example, when you choose another device, and click on the Ports tab and the Physical Ports tab, the Administrative State heading is not displayed. However, when you click on the SONET Channels tab, the Administrative State heading appears.

10

Move the file to another station, as required, for inventory analysis or post-processing.

END OF STEPS

21.76 How do I manage main database audit logs?

21.76.1 Overview

As part of the main database security, audit log files are automatically created to track database session creation activities. The NFM-P does not automatically remove the files. You must monitor the directory that contains the audit log files to ensure that the files do not consume excessive disk space.

21.77 How do I reduce the number of Oracle audit logs?

21.77.1 Steps

1 _____
Log in to the main database station as the Oracle management user.

 **Note:** The Oracle management user name is specified during database installation; the default is 'oracle'.

2 _____
Navigate to the /opt/nsp/nfmp/oracle19/rdbms/audit directory.

3 _____
Archive and delete the files, as required. If the number of audit files increases quickly, you may need to perform this procedure more frequently.

END OF STEPS _____

21.78 How do I check for performance monitoring statistics collection?

21.78.1 Process

Use the performance monitoring statistic log records to determine whether performance statistics are collected within the scheduled interval using the client GUI.

1 _____
Choose Tools→Statistics→Statistics Manager from the NFM-P main menu. The Statistics Manager form opens.

2 _____
Set the Statistics Type parameter to Statistics Record to retrieve a list of historical data for the type of logged statistics.

3

Choose a type of statistics to collect. For example, to check interface statistics for managed devices, choose Interface Additional Stats (Physical Equipment).

4

Perform one of the following:

- a. To collect statistics for the past hour, click Search. Go to [Step 6](#).
- b. To collect statistics based on a set of user-defined criteria, choose No Filter.

5

Configure the filter criteria and click Search.



Note: You must specify a filter to limit the number of log records to less than 15 000; otherwise, a problem encountered form appears.

6

Review the data for the selected statistic.

1. Click on the Monitored Object or Monitored Object Name headings to sort the historical statistics records by type of object.
2. Review the Time Captured heading for one or more objects.
Verify that the time captured intervals match the intervals set for the object or the statistic logging class.
If the time captured intervals are not sufficient, there will be gaps in the historical record.

7

If there are gaps in the historical record, check the mediation policy to ensure that:

- polling is enabled and administratively up
- the polling interval for a specific MIB or MIB entry is sufficient for collecting the required statistics



Note: Each row that represents a log record shows the Suspect column. When a check mark is present for an interval, there may have been a problem with collection during that interval.

8

Record the data for the selected device and type of statistics. Use this data as a base measurement to verify that statistics data was collected correctly over the scheduled interval.

END OF STEPS

Monthly maintenance

21.79 Why generate and store a user account list?

21.79.1 Overview

An NFM-P administrator must keep a record of NFM-P users in order to:

- associate staff names with user accounts
- provide account information to technical support for system access
- review user account privileges

21.80 How do I generate and store user account data?

21.80.1 Steps

- 1 _____
As the admin user, choose Administration→Security→NFM-P User Security from the NFM-P main menu. The NFM-P User Security -- Security Management (Edit) form opens.
- 2 _____
Click on the Users tab.
- 3 _____
Click Search without setting any filtering. The complete list of user accounts appears.
- 4 _____
Organize the list of users. For example, to organize the list by the type of group that the user belongs to, click on the User Group column heading. The user accounts are listed alphabetically by user group.
- 5 _____
Save the list of user accounts.
 1. Right-click on the user name list heading and choose Save To File. The Save form opens.
 2. Enter a name for the user account list, for example, NOCabc_useraccounts_yearmonthday.
 3. Click on the Files of Type pull-down menu to specify the file type.
 4. Browse to choose a location in which to save the file.
 5. Click Save. The file is saved to the selected location in the specified format with the appropriate extension.

6

Move the account list to a secure location. Store the latest version of the list and keep existing versions of the list for historical purposes.

END OF STEPS

21.81 How do I test an NFM-P main database restore?

21.81.1 Purpose

It is strongly recommended that you regularly test a recent main database backup to ensure that you can use the backup to restore the database in the event of a failure.

Perform this procedure test the success of a main-database restore operation.

 **Note:** You require root user privileges on the station that hosts the restored database.

 **Note:** You require the Oracle management user name, group name, and password from the main database.



CAUTION

Service Disruption

Restoring a main database on a station that has connectivity to the managed network or other NFM-P components can cause a service disruption.

Ensure that you perform the procedure only on an isolated station.

 **Note:** Before you can test a database restore on a station, you must ensure that no NFM-P software is installed on the station.

21.81.2 Steps

1

Generate comparison points for the main database, for example, the number of managed devices and cards, by creating an inventory of information, as described in the *NSP NFM-P User Guide*. This information is used to compare against the restored database information in a test environment to check the validity of the database backup.

2

Ensure that the station on which you plan to restore the database, called the test station, has the same system configuration as the actual database station, for example, partitioning, OS version, and OS patch level.

3

Identify a recent main database backup.

4 _____
Log in to the test station as the root user.

5 _____
Copy the database backup file set to the test station.

i **Note:** The path to the backup file set on the test station must be the same as the path of the backup file set on the database station.

6 _____
Transfer the following NFM-P installation files for the existing release to an empty directory on the test station:

- nsp-nfmp-jre-*R.r.p-rel.v.rpm*
- nsp-nfmp-config-*R.r.p-rel.v.rpm*
- nsp-nfmp-oracle-*R.r.p-rel.v.rpm*
- nsp-nfmp-main-db-*R.r.p-rel.v.rpm*
- OracleSw_PreInstall.sh

where

R.r.p is the NSP release identifier, in the form *MAJOR.minor.patch*

v is a version identifier

7 _____
Open a console window.

8 _____
Navigate to the directory that contains the NFM-P installation files.

9 _____
Enter the following:

```
# chmod +x * ↵
```

10 _____
Enter the following:

```
# ./OracleSw_PreInstall.sh ↵
```

i **Note:** A default value is displayed in brackets []. To accept the default, press ↵.

The following prompt is displayed:

```
This script will prepare the system for a new install/restore of an  
NFM-P Version R.r Rn database.
```

```
Do you want to continue? [Yes/No]:
```

11

Enter Yes. The following prompt is displayed:

```
Enter the Oracle dba group name [group]:
```

12

Enter the group name of the Oracle management user from the current database deployment.

The following messages and prompt are displayed:

```
Creating group group if it does not exist ... done
```

```
Enter the Oracle user name [user]:
```

13

Enter the Oracle management user name from the current database deployment.

The following messages and prompt are displayed:

```
Oracle user [user] new home directory will be  
[/opt/nsp/nfmp/oracle19].
```

```
Checking or Creating the Oracle user home directory  
/opt/nsp/nfmp/oracle19...
```

```
Checking user user...
```

```
Adding user...
```

```
Changing ownership of the directory /opt/nsp/nfmp/oracle19 to  
user:group.
```

```
About to unlock the UNIX user [user]
```

```
Unlocking password for user user.
```

```
passwd: Success
```

```
Unlocking the UNIX user [user] completed
```

```
Please assign a password to the UNIX user user ..
```

```
New Password:
```

14

Enter the password of the Oracle management user.

The following prompt is displayed:

```
Re-enter new Password:
```

15

Re-enter the password. The following message is displayed if the password change is successful:

```
passwd: password successfully changed for user
```

The following message and prompt are displayed:

```
Specify whether an NFM-P server will be installed on this workstation.
```

The database memory requirements will be adjusted to account for the additional load.

Will the database co-exist with an NFM-P server on this workstation [Yes/No]:

16

Enter Yes or No, as required, based on the existing NFM-P deployment.

Messages like the following are displayed as the script execution completes:

```
INFO: About to set kernel parameters in /etc/sysctl.conf...
INFO: Completed setting kernel parameters in /etc/sysctl.conf...
INFO: About to change the current values of the kernel parameters
INFO: Completed changing the current values of the kernel parameters
INFO: About to set ulimit parameters in /etc/security/limits.conf...
INFO: Completed setting ulimit parameters in /etc/security/limits.conf...
INFO: Completed running Oracle Pre-Install Tasks
```

17

Enter the following:

```
# dnf install *.rpm ↵
```

The dnf utility resolves any package dependencies, and displays the following prompt:

```
Total size: nn G
Installed size: nn G
Is this ok [y/d/N]:
```

18

Enter y. The following and the installation status are displayed as each package is installed:

```
Downloading packages:
Running transaction check
Running transaction test
Transaction test succeeded
Running transaction
```

The package installation is complete when the following is displayed:

```
Complete!
```

19

Enter the following:

```
# samrestoreDb path ↵
```

where *path* is the absolute path of the directory that contains the database backup file set

The database restore begins.

If the backup file set has been created using file compression, messages like the following are displayed.

```
About to uncompress backup files under path
```

```
Completed uncompressing backup files under path
```

Messages like the following are displayed as the restore progresses.

```
Restore log is /opt/nsp/nfmp/db/install/NFM-P_Main_Database.restore.  
yyyy.mm.dd-hh.mm.ss.stdout.txt
```

```
<date time> working..
```

```
<date time> Performing Step 1 of 7 - Initializing ..
```

```
<date time> Executing StartupDB.sql ...
```

```
<date time> Performing Step 2 of 7 - Extracting backup files .....
```

```
<date time> Performing Step 3 of 7 - Restoring archive log files ..
```

```
<date time> Performing Step 4 of 7 - Executing restore.rcv .....
```

```
<date time> Performing Step 5 of 7 - Restoring Accounting tablespaces  
.....
```

```
<date time> Performing Step 6 of 7 - Opening database .....
```

```
<date time> working....
```

```
<date time> Executing ConfigRestoreDB.sql .....
```

```
<date time> working.....
```

```
<date time> Performing Step 7 of 7 - Configuring SAM Server settings  
...
```

The following is displayed when the restore is complete:

```
<date time> Database restore was successful
```

```
DONE
```

20

Review the comparison points of the restored database with the actual database, as generated in [Step 1](#) . If the databases are the same, the backup is valid and the restore operation is successful.

END OF STEPS

21.82 Why check the NFM-P platform performance?

21.82.1 Overview

Use the following procedure to test the NFM-P platform performance and to record base measures. You can compare performance monthly to:

- collect base measure information related to platform performance
- ensure that there is no degradation in performance

If the performance degrades, collect the necessary logs and performance data and contact technical support.

21.82.2 Checking Windows client performance

You can compare Windows client station performance monthly to:

- collect base measure information related to platform performance
- ensure that there is no degradation in performance

21.83 How do I check Windows client station performance?

21.83.1 Steps

- 1 _____
Open a command window on the client station.
- 2 _____
Enter the following at the command prompt:
`ping station_name` ↵
where *station_name* is the IP address or hostname, if DNS is used, of the main server to which you need to test connectivity
- 3 _____
Review the ping output for round-trip delays or lost packets. Resolve any connectivity issues that cause delays or dropped packets. Store ping round-trip delay or lost-packet data as a performance base measure for the station. You can use the data for future performance comparisons.
- 4 _____
Open Windows Task Manager.
- 5 _____
Check performance using the appropriate Task Manager tab.
 - a. Click on the Processes tab. A list of processes appears.
Sort the processes by CPU usage. The name of each NFM-P process begins with javaw. The CPU usage percentage for each NFM-P process must fall within your IT specifications or the established performance base measures.
 - b. Click on the Performance tab. The CPU and page file usage charts appear.
The memory and page-file usage percentages must fall within your IT specifications or the established performance base measures.
 - c. Click on the Networking tab. The Local Area Connection chart appears.

How do I check network connections between components?

Network utilization greater than 10 or 20 percent may indicate collisions or other LAN problems that could affect performance in the network management domain.

6

Choose File→Exit Task Manager to close the form.

7

Open a console window.

8

Type:

```
tracert station_name ↵
```

where *station_name* is the IP address or hostname of the main server to which you need to test connectivity

The tracert command provides details about network connectivity.

9

Review the tracert data, including:

- number of hops required to reach the main server
- average time between hops

Record the data for future base measure comparison. For example, when the number of hops between a client GUI and main server increases over time, traffic takes longer to travel between them, which can degrade performance.

10

Check regularly for advisories related to the OS. If updates or patches are required, contact technical support for information about potential effects on the NFM-P.

END OF STEPS

21.84 How do I check network connections between components?

21.84.1 Overview

Use the ping and traceroute functions each month to check LAN TCP/IP connectivity between NFM-P components, and track the measurements over time to establish trends for extrapolation during network planning, and to identify changes in latency. Contact your IT department if you suspect a communication problem between components.

21.85 How do I measure NFM-P performance?

21.85.1 Steps

- 1 _____
Log into a main server, auxiliary server, or main database station as the root user.
- 2 _____
Open a console window.
- 3 _____
Enter the following to list the processes that have the highest CPU usage:

```
# top ↵
```

Depending on your system configuration, approximately the top 20 processes are displayed. The top NFM-P process, by CPU usage, is typically the Java process.
- 4 _____
Review the output; see the top man page for a description of the output fields.
- 5 _____
Record the data for future performance comparison. Look for data that indicates excessive or continuously increasing CPU usage by the Java process.
- 6 _____
Press Ctrl+C to stop the command.
- 7 _____
Enter the following to list CPU resource usage information:

```
# mpstat nn ↵
```

where *nn* is the time, in seconds, between CPU polls; a value between 10 and 60 is recommended
- 8 _____
Review the command output; see the mpstat man page for a description of the output fields.
- 9 _____
Record the data for future performance comparison. Look for a difference in the output for a similar load on each station; a difference may indicate CPU performance degradation.
- 10 _____
Press Ctrl+C to stop the command.

-
- 11 _____
- Enter the following to list disk performance information:
- ```
iostat -x n ↵
```
- where *nn* is the time, in seconds, during which you want to collect data; a starting value of 2 is recommended
- 12 \_\_\_\_\_
- Review the output; see the `iostat` man page for a description of the output fields.
- 13 \_\_\_\_\_
- Record the data for future performance comparison. Look for a difference in the output for a similar load on each station that may indicate disk performance degradation on a station.
- 14 \_\_\_\_\_
- Press Ctrl+C to stop the command.
- 15 \_\_\_\_\_
- Use an OS command to list network interface throughput and error statistics.
- 16 \_\_\_\_\_
- Record the data for future performance comparison. Look for a difference in the output for a similar load on each station that may indicate network performance degradation.
- 17 \_\_\_\_\_
- Close the console window.
- END OF STEPS \_\_\_\_\_

## 21.86 How do I check network management connections?

### 21.86.1 Steps

- 1 \_\_\_\_\_
- Open a console window on the station.
- 2 \_\_\_\_\_
- Ping the hostname of another station in the network management domain by entering the following:
- ```
ping station_name ↵
```
- where *station_name* is the IP address or hostname of the other station

3

Review the output. The following is an example of ping output:

```
PING station_name: 56 data bytes
64 bytes from hostname (IP_address): icmp_seq=0, time=nnn ms
64 bytes from hostname (IP_address): icmp_seq=1, time=nnn ms
64 bytes from hostname (IP_address): icmp_seq=2, time=nnn ms
----station_name PING Statistics----
3 packets transmitted, 3 packets received, 0% packet loss
round-trip (ms) min/avg/max = 0/0/1
```

LAN congestion may be a problem if packets are received out of order, are dropped, or take too long to complete the round trip.

4

Store the output for future base measure comparison.

Compare the output over time to ensure that changes in the data are not caused by deteriorating LAN conditions.

5

Check the routing information.

1. Open a console window on the station.
2. Enter one of the following traceroute commands to determine the path taken to a destination by an ICMP echo request message:
 - `tracert` ↵ on a Windows station
 - `tracert` ↵ on a Windows stationThe list of near-side interfaces in the path between a source host and a destination device is displayed. The near-side interfaces are the interfaces closest to the source host.

6

Store the output as a record for future base measure comparisons. Compare routes over time to ensure that there is optimal connectivity.

7

To check the routing tables for the platform:

1. Open a console window on the station.
2. To view the active routes for the platform, type:

```
netstat -rn
```

 ↵

The following information is displayed:

 - network destination and gateway IP addresses
 - gateway used to reach the network destination
 - IP address of the interface on which communication occurs
 - metric value of the route

8

Store the output as a record for future base measure comparison. Compare routes over time to ensure that there is optimal connectivity.

END OF STEPS

21.87 How do I test main server and database redundancy switches?

21.87.1 Overview

In a redundant NFM-P system, performing regular main server and database redundancy tests is important for the following reasons:

- to ensure that main server and database redundancy functions correctly and responsively
- to identify conditions that may interfere with an NFM-P upgrade



Note: It is strongly recommended that you perform a main server activity switch and a database switchover monthly, or at least quarterly, if a monthly test is not possible. For information about performing a server activity switch, see [17.11 “How do I perform a server activity switch?” \(p. 404\)](#). For database switchover information, see [17.13 “How do I perform a main database switchover using the NFM-P client GUI?” \(p. 406\)](#) or [17.14 “How do I perform a main database switchover using a CLI script?” \(p. 407\)](#). Contact technical support for further assistance.

22 Classic management database administration

22.1 What is the NFM-P main database?

22.1.1 Description

This section describes the NFM-P main database, and how to manage the associated data integrity and security functions.

An NFM-P main database stores classic mediation network data that includes object configurations, device backups, and statistics: The NFM-P uses the data to create a network model for use by NFM-P management functions.

An NFM-P system requires a central database for persistent storage. The database can be on the same station as the main server, or on a separate station. A redundant NFM-P deployment has two identical main database instances in a synchronized primary/standby configuration to limit data loss in the event of a failure.

You can manage the following database functions and parameters:

- security
- statistics data retention
- data synchronization
- backups and restores
- historical record retention
- object ageout
- log storage
- error monitoring
- alarm handling

22.1.2 Main database safeguards

In addition to the protection of system redundancy, the NFM-P has mechanisms that raise alarms for the following:

- database disk and tablespace capacity issues
- redundancy events, misconfiguration, and failures
- database backup misconfiguration and failures
- archive log management actions and failures
- internal errors that may represent a security risk
- size constraint and ageout constraint policy violations

22.1.3 References

See the following for more information:

- *NSP Planning Guide*—main database platform and network requirements
- *NSP Installation and Upgrade Guide*—main database deployment
- *NSP Troubleshooting Guide*—main database troubleshooting

- NSP NFM-P Alarm Search Tool—alarm descriptions, raising and clearing conditions, and remedial actions

22.2 How do I restore and reinitiate the NFM-P main database?

22.2.1 Description



CAUTION

Service Disruption

A main database restore requires a shutdown of each main database and main server in the NFM-P system, which causes a network management outage.

You must perform a database restore only during a scheduled maintenance period, and contact technical support before you attempt to restore a main database.

You can restore a main database using a backup copy.

In a redundant system, you must perform one or both of the following to regain main database function and redundancy, depending on the failure type.

- Restore the primary main database.
- Reinitiate the standby main database.

Both operations are required after a primary database failure. After a standby database failure, no restore operation is required, but you must reinitiate the primary database on the standby database station to restore redundancy. You can use the NFM-P client GUI or a CLI script to reinitiate a database.



Note: In a redundant system, you can restore a main database backup only on a primary database station. To restore a database backup on a station other than the primary station, you must do the following on the station before you attempt the restore:

- Uninstall the main database, if it is installed.
- Install a primary database on the station.

In a redundant system, you can reinitiate a database only on a standby database station. To reinitiate a database on a station other than the standby station, you must do the following on the station before you attempt the reinitiation:

- Uninstall the main database, if it is installed.
- Install a standby database on the station.

See [22.15 “How do I restore a standalone main database?”](#) (p. 652) for information about restoring a standalone main database. See [22.16 “How do I restore the primary main database in a redundant system?”](#) (p. 660) for information about restoring a redundant main database. See [22.20 “How do I reinitiate the main database from the client GUI?”](#) (p. 680) and [22.21 “How do I reinitiate the main database from a CLI?”](#) (p. 681) for information about reinitiating a primary main database on a standby database station.

22.3 Workflow: NFM-P database management

22.3.1 Stages

i **Note:** It is strongly recommended that you verify the checksum of each file that you download from the [NSP download page](#) on the Nokia Support portal. You can compare the SHA-256 checksum value in the Packages.sha256sum on the download page to the output of the RHEL sha256sum command. See the RHEL sha256sum man page for information.

Database properties and status

- 1 _____
Display the main database properties; see [22.4 “How do I view the main database properties?” \(p. 637\)](#) .

Database operation and security

- 2 _____
As a security precaution, configure the number of failed Oracle database user login attempts that the NFM-P allows before a user is locked out; see [22.5 “How do I configure the Oracle database user lockout threshold?” \(p. 638\)](#) .
- 3 _____
As required, unlock the Oracle database user account after multiple login failures; see [22.6 “How do I unlock the Oracle database user account?” \(p. 639\)](#) .
- 4 _____
Configure how the NFM-P responds to Oracle database errors; see [22.7 “How do I configure Oracle database error monitoring?” \(p. 641\)](#) .
- 5 _____
Configure size constraint policies to regulate the number of records retained in the main database; see [22.8 “How do I configure a size constraint policy?” \(p. 641\)](#) .
- 6 _____
Configure ageout constraint policies to define a configurable ageout time for a specific object type in the main database; see [22.9 “How do I configure an ageout constraint policy?” \(p. 643\)](#) .
- 7 _____
Manage main database disk usage by configuring policies to manage the file size and number of archive log and core dump files; see [22.10 “How do I create a database file policy to manage database log or core dump files?” \(p. 644\)](#) .

8

Configure the statistics data retention period for the main database; see [22.11 “How do I configure the statistics data retention period for the main database?”](#) (p. 646) .

Backup, restore, and maintenance

9

Perform an immediate full or partial main database backup; see [22.12 “How do I back up the main database from the client GUI?”](#) (p. 646) or [22.13 “How do I back up the main database from a CLI?”](#) (p. 648) .

10

Schedule a regular main database backup; see [22.14 “How do I schedule main database backups?”](#) (p. 651) .

11

Restore the main database in a standalone system; see [22.15 “How do I restore a standalone main database?”](#) (p. 652).

12

Restore the main database in a redundant system; see [22.16 “How do I restore the primary main database in a redundant system?”](#) (p. 660).

13

As required, delete the inactive residential subscriber instances from the main database; see [22.17 “How do I delete the inactive residential subscriber instances?”](#) (p. 671).

14

Test the main database restore function to ensure that main database backups are viable in the event of a failure; see [21.81 “How do I test an NFM-P main database restore?”](#) (p. 621) .

15

Export a main database to a file set; see [22.18 “How do I export an NFM-P main database?”](#) (p. 673).

16

Import a main database from a file set; see [22.19 “How do I import an NFM-P main database?”](#) (p. 676).

17

Verify the synchronization of NE and main database information; see [21.68 “How do I check the main database performance?”](#) (p. 609) .

Redundancy functions

18

Perform a main database switchover; see [17.12 “How do I configure main database switchover behavior?”](#) (p. 405) , [17.13 “How do I perform a main database switchover using the NFM-P client GUI?”](#) (p. 406) , or [17.14 “How do I perform a main database switchover using a CLI script?”](#) (p. 407) .

19

Enable or disable automatic database realignment on a main server; see [17.15 “How do I enable or disable automatic database realignment?”](#) (p. 408).

20

Re-establish redundancy after a database activity switch or similar maintenance activity; see [22.20 “How do I reinitialize the main database from the client GUI?”](#) (p. 680) and [22.21 “How do I reinitialize the main database from a CLI?”](#) (p. 681).

22.4 How do I view the main database properties?

22.4.1 Steps

1

Choose Administration→Database from the NFM-P main menu. The Database Manager (Edit) form opens and displays information that includes the following:

- Database Name
- Instance Name
- Listener Port—the port on the main server for database communication
- DBID—the Oracle database ID, sometimes called the SID
- Creation Time—the database creation time
- Version—the Oracle version identifier
- IP Address—the database IP address that the main and auxiliary servers use
- Host Name—the database station hostname
- Open Mode—specifies the type of database access
- Archive Log Mode—specifies whether to archive the database log files; configured during database installation
- Protection Mode—the database protection mode, which cannot be changed

2

View the information.

-
- 3 _____
Close the Database Manager (Edit) form.

END OF STEPS _____

22.5 How do I configure the Oracle database user lockout threshold?

22.5.1 Purpose

As a security precaution, you can configure the number of consecutive Oracle database user login failures that are tolerated before the user account is locked.

If the Oracle database user account is locked because of too many login failures, you can unlock the account by performing [22.6 “How do I unlock the Oracle database user account?”](#) (p. 639).

i **Note:** In a redundant deployment, you perform the procedure on the primary database station. After you perform the procedure, the primary database automatically copies the configuration change to the standby database.
The configuration change that you make in this procedure is not affected by a subsequent database upgrade.

22.5.2 Steps

- 1 _____
Log in to the main database station as the Oracle management user.

i **Note:** The Oracle management user name is specified during database installation; the default is 'oracle'.

- 2 _____
Open a console window.

- 3 _____
Enter the following:
`bash$ /opt/nsp/nfmp/db/install/config/samdb/SAMDb_security.sh ↵`

The following prompt is displayed:

Please select one of the following options:

- 1) Setting failed login attempts
- 2) Unlock database user
- 0) Exit

Please enter (1,2 or 0) :

- 4 _____
Enter 1 ↵.

The following prompt is displayed:

Please select one of the following options:

- 1) Setting the number of failed login attempts
- 2) Remove the number of failed login attempts setting (no checking)
- 0) Exit

Please enter (1,2 or 0) :

5

To specify the allowed number of login failures, perform the following steps.

1. Enter 1 ↵.

The following prompt is displayed:

This value will be used for setting the number of failed login attempts before locking the database user account.

Please enter value for number of failed login attempts(20 to 1000) (30) :

2. Specify a value between 20 and 1000 and press ↵.

The following messages are displayed:

About to change the Oracle database user settings

Completed changing the Oracle database user settings

3. Go to [Step 7](#) .

6

To disable checking for failed login attempts, enter 2 ↵.

The following messages are displayed, and the NFM-P no longer locks the Oracle database user account after multiple login failures.

About to change the Oracle database user settings

Completed changing the Oracle database user settings

7

Close the console window.

END OF STEPS

22.6 How do I unlock the Oracle database user account?

22.6.1 Purpose

Perform this procedure to unlock the locked Oracle database user account.

[22.5 "How do I configure the Oracle database user lockout threshold?"](#) (p. 638) describes how to configure the account lockout criteria.

i **Note:** In a redundant deployment, you perform the procedure on the primary database station. After you perform the procedure, the primary database automatically copies the configuration change to the standby database.
The configuration change that you make in this procedure is not affected by a subsequent database upgrade.

22.6.2 Steps

1 _____
Log in to the main database station as the Oracle management user.

i **Note:** The Oracle management user name is specified during database installation; the default is 'oracle'.

2 _____
Open a console window.

3 _____
Enter the following:
`bash$ /opt/nsp/nfmp/db/install/config/samdb/SAMDb_security.sh ↵`
The following prompt is displayed:
Enter the password for the "sys" user (terminal echo is off):

4 _____
Enter the Oracle SYS user password and press ↵.
The following prompt is displayed:
Please select one of the following options:
1) Setting failed login attempts
2) Unlock database user
0) Exit
Please enter(1,2 or 0):

5 _____
Enter 2 ↵.
The following messages are displayed, and the Oracle database user account is unlocked.
About to unlock the database user *username*
Completed unlocking the database user *username*

6 _____
Close the console window.

END OF STEPS _____

22.7 How do I configure Oracle database error monitoring?

22.7.1 Purpose

You can configure how the NFM-P handles Oracle database errors to provide monitoring information that may help with troubleshooting or the detection of security violations such as SQL injection attacks. When database error monitoring is enabled, the NFM-P raises an alarm when the Oracle software reports an error, for example, an invalid SQL statement.

22.7.2 Steps

- 1 _____
Choose Administration→Database from the NFM-P main menu. The Database Manager (Edit) form opens.
- 2 _____
To enable database error monitoring, select the Enable Database Error Monitoring parameter.
- 3 _____
To disable database error monitoring, deselect the Enable Database Error Monitoring parameter.
- 4 _____
Save your changes and close the form.

END OF STEPS _____

22.8 How do I configure a size constraint policy?

22.8.1 Purpose

Size constraint policies regulate the number of historical records that the main database retains before purging records. The scheduling of tasks through the NFM-P can generate a large volume of archived result information if left unchecked. Size constraint policies control the volume of information stored by defining thresholds for various record classes. When the number of records for a specific class or group of classes reaches a threshold specified in the policy, the NFM-P deletes a specified number of the oldest objects that are associated with the class or group of classes.

22.8.2 Steps

- 1 _____
Choose Administration→Constraint Policies→Size Constraint Policies from the NFM-P main menu. The Size Constraint Policies form opens.

2

Click Create or choose a policy and click Properties. The Size Constraint Policy (Create | Edit) form opens.



Note: The NFM-P is preconfigured with the following default size constraint policies for various record classes:

- Script Management Results
- Clear Requests
- CPAM Protocol Data
- Work Order Import Logs
- LTE User Stats Query Output Snapshots

3

Configure the general policy parameters.

4

Click on the Constrained Packages tab.

5

Right-click on the Size Constraint Policy icon and choose Select Packages.

6

Choose a size constraint package and click OK. The package appears in the navigation tree under the Size Constraint policy. Go to [Step 7](#) if the package selected supports a sub-class package, for example, the dhcp package supports three sub-class packages. Otherwise, go to [Step 9](#).

7

Right-click on the package icon and choose Select Classes. The Select Size Constrained Classes form opens.

8

Choose a sub-class package and click OK to Save your changes and close the form.

9

Close the Size Constraint Policy (Create|Edit) form.

END OF STEPS

22.9 How do I configure an ageout constraint policy?

22.9.1 Purpose

An ageout constraint policy defines the database ageout period for a specific object type. When the age of an object reaches the ageout value, the NFM-P deletes the object from the database.

The NFM-P supports ageout constraint policies to define the period of time the database retains persisted virtual network objects. These policies are the dctr policies listed below. See the NFM-P VSAP User Guide for more information about virtual network object persistence in data center networks.

 **Note:** The NFM-P has a number of preconfigured ageout constraint policies.

22.9.2 Steps

1 _____

Choose Administration→Constraint Policies→Ageout Constraint Policies from the NFM-P main menu. The Ageout Constraint Policies form opens.

2 _____

Select a policy and click Properties. The Ageout Constraint Policy form opens.

3 _____

Review the Object Count information in the Status panel. The information refers to the most recent object deletion, and can help you define the appropriate ageout time and deletion interval values for the policy.

4 _____

Configure the parameters.

 **Note:** The Qualified Ageout Time defaults are guidelines. Consider the following when setting the Qualified Ageout Time:

- A small value can prevent excessive database table growth.
- The value must be great enough to allow sufficient time to upload the database records to a third-party utility.

5 _____

Save your changes and close the form.



CAUTION

Service Disruption

Modifying the server configuration can have serious consequences including service disruption.

Contact technical support before you attempt to modify the server configuration.

If required, edit the ageout constraint policy configuration file to modify the following parameters in the Deletion Interval panel:

- Synchronization Time—shown as `ageoutSyncTime` in the configuration file
- Interval (hours)—shown as `ageoutInterval` in the configuration file

i **Note:** You must perform the following steps on each main server in the NFM-P system.

1. Log in to the main server station as the `nsp` user.
2. Open a console window.
3. Navigate to the `/opt/nsp/nfmp/server/nms/config` directory.
4. Open the `AgeoutConstraints.xml` file using a plain-text editor.
5. Locate the following XML tag:

```
<ageout>
```

6. Locate the object class section that you need to modify; the following code shows the residential subscriber instance object class as an example:

```
<class name="ressubscr.ResidentialSubscriberInstance"
  ageoutSyncTime="00:00"
  ageoutInterval="1">
/class>
```

7. Modify the `ageoutSyncTime` and `ageoutInterval` values, as required.
8. Save and close the `AgeoutConstraints.xml` file.
9. On a standalone main server, or the primary main server in a redundant system, enter the following:

```
bash$ /opt/nsp/nfmp/server/nms/bin/nmserver.bash read_config ↵
```

The NFM-P puts the configuration change into effect.

10. Close the console window.

END OF STEPS

22.10 How do I create a database file policy to manage database log or core dump files?

22.10.1 Purpose

You can create database file policies to manage the file size and number of archives for stored

How do I create a database file policy to manage database log or core dump files?

alert, listener, trace, audit, and core dump files. When the size and number of files are left unbounded, excessive database disk capacity is consumed.

Database trace, alert, and audit log files are compressed and stored in the alert log directory. Database listener log files are stored in the listener log directory.

i **Note:** For historical or troubleshooting purposes, recommends that you archive the main database log files on a regular basis.

22.10.2 Steps

- 1 _____
Choose Administration→Database from the NFM-P main menu. The Database Manager (Edit) form opens.
- 2 _____
Click on the File Policies tab.
- 3 _____
Click Database File Policies or choose a default policy and click Properties. The Database File Policies Create | Edit) form opens. If you selected a default policy, go to [Step 5](#) .
- 4 _____
Click Create.
- 5 _____
Configure the required general file policy parameters and Purge Details panel parameters.
- 6 _____
Click OK to save your changes and close the form.
- 7 _____
If required, click Select to apply the new purge details to a default policy.
- 8 _____
Save your changes and close the Database Manager (Edit) form.

END OF STEPS _____

22.11 How do I configure the statistics data retention period for the main database?

22.11.1 Steps

1 _____
Choose Administration→Database from the NFM-P main menu. The Database Manager (Edit) form opens.

2 _____



CAUTION

Service Disruption

Configuring the parameter can seriously affect NFM-P system performance.

Consult technical support before you configure the parameter.

Configure the Accounting Statistic Data Retention Period (Days) parameter.

3 _____

Save your changes and close the Database Manager (Edit) form.

END OF STEPS _____

22.12 How do I back up the main database from the client GUI?

22.12.1 Purpose

Perform this procedure to initiate an on-demand main database backup using the client GUI. You can perform a full backup, which includes the entire database, or a partial backup, which excludes accounting statistics data.



CAUTION

Service Disruption

The disk partition that is to contain the database backup must have sufficient space for the database backup file set.

Ensure that the backup directory is at least five times as large as the expected database backup size. For more information, contact technical support or see the NSP Planning Guide.



Note: The NFM-P backs up the Oracle encryption wallet during a database backup, and restores the wallet during a database restore. In a redundant deployment, the NFM-P automatically replicates the encryption wallet from the primary to the standby database after the standby database reinstatement.

 **Note:** During a database backup, the performance of GUI or XML API operations may be affected. It is recommended that you perform a database backup only during a period of low NFM-P activity.

22.12.2 Steps

1 _____
Choose Administration→Database from the NFM-P main menu. The Database Manager form opens.

2 _____
Click on the Backup tab.

3 _____



Before the NFM-P performs a database backup, it deletes the contents of the specified backup directory.

Ensure that the backup directory that you specify does not contain files that you need to retain.



The Manual Backup Directory path must not include the main database installation directory, or data loss may occur.

Ensure that the directory path does not include /opt/nsp/nfmp/db.

 **Note:** The Oracle management user requires read and write permissions on the backup directory. The user and group names are specified during database installation; the default is 'oracle' in the 'dba' group.

Configure the following parameters:

- Manual Backup Directory
- Enable Backup File Compression

4 _____
Perform one of the following.

- a. Click Partial Backup.
- b. Click Full Backup.

5

Click Yes. The full or partial backup operation begins, and the Backup State indicator reads In Progress.

Depending on the database size, a backup may take considerable time.

6

If required, monitor the Backup Status information, which includes the following:

- Scheduled Backup—whether scheduled backup is configured
- Backup State—state of current backup operation; dynamically updated
- Next Scheduled Backup Time—time of next scheduled backup
- Last Successful Backup Time—completion time of latest successful backup
- Last Successful Backup Type—type of latest successful backup
- Last Attempted Backup Time—when latest attempted backup began
- Last Attempted Backup Type—type of latest attempted backup
- Directory of the Last Successful Backup—location of latest successful backup
- Host Name of the Last Successful Backup—hostname of station that performed latest successful backup

7

Close the Database Manager (Edit) form.

The database backup creates the following summary file in the same directory as the backup files:

BACKUP_SUMMARY.INFO

The summary file contains detailed backup information that includes the backup completion time, and the name and size of each backup file.

END OF STEPS

22.13 How do I back up the main database from a CLI?

22.13.1 Purpose

Perform this procedure to initiate an on-demand main database backup using CLI. You can perform only a full database backup from a CLI. To perform a partial backup, see [22.12 “How do I back up the main database from the client GUI?”](#) (p. 646).



CAUTION

Service Disruption

The disk partition that is to contain the database backup must have sufficient space for the database backup file set, or system performance may be compromised.

Ensure that the backup directory is at least five times as large as the expected database backup size. For more information, contact technical support or see the NSP Planning Guide.



Note: The NFM-P backs up the Oracle encryption wallet during a database backup, and restores the wallet during a database restore. In a redundant deployment, the NFM-P automatically replicates the encryption wallet from the primary to the standby database after the standby database instantiation.



Note: During a database backup, the performance of GUI or XML API operations may be affected. It is recommended that you perform a database backup only during a period of low NFM-P activity.

22.13.2 Steps

1

Log in as the root user on the main database station.



Note: In a redundant NFM-P system, you must log in to the primary database station.

2

Open a console window.

3



CAUTION

Data Loss

Before the NFM-P performs a database backup, it deletes the contents of the specified backup directory.

Ensure that the backup directory that you specify in this step does not contain files that you need to retain.



CAUTION

Data Loss

The backup directory path must not include the main database installation directory, or data loss may occur.

Ensure that the directory path does not include `/opt/nsp/nfmp/db`.

i **Note:** The Oracle management user requires read and write permissions on the backup directory. The user and group names are specified during database installation; the default is 'oracle' in the 'dba' group.

Perform one of the following.

a. Enter the following to back up the database without using file compression:

```
# sambackupDb backup_directory ↵
```

where *backup_directory* is the absolute path of the directory that is to contain the database backup file set

b. Enter the following to back up the database using file compression:

```
# sambackupDb backup_directory compress ↵
```

where *backup_directory* is the absolute path of the directory that is to contain the database backup file set

i **Note:** Depending on the database size, a backup may take considerable time.

The database backup begins, and messages like the following are displayed as the backup progresses:

```
Backup log is /opt/nsp/nfmp/db/install/NFM-P_Main_Database.backup.  
yyyy.mm.dd-hh.mm.ss.stdout.txt
```

```
<date time> working..
```

```
<date time> Performing Step 1 of 4 - Initializing ..
```

```
<date time> Performing Step 2 of 4 - Backup archive logs ..
```

```
<date time> Performing Step 3 of 4 - Backup the database .....
```

```
<date time> Performing Step 4 of 4 - Finalizing .....
```

The following is displayed when the backup is complete:

```
<date time> Database backup was successful
```

```
DONE
```

4

When the backup is complete, close the console window.

The database backup creates the following summary file in the same directory as the backup files:

```
BACKUP_SUMMARY.INFO
```

The summary file contains detailed backup information that includes the backup completion time, and the name and size of each backup file.

END OF STEPS

22.14 How do I schedule main database backups?



CAUTION

Service Disruption

The disk partition that is to contain the database backup must have sufficient space for the database backup file set, or system performance may be compromised.

Ensure that the backup directory is at least five times as large as the expected database backup size. For more information, contact technical support or see the NSP Planning Guide.



CAUTION

Service Disruption

A main database backup consumes considerable system resources.

Ensure that you specify a backup schedule of reasonable frequency, for example, daily.



Note: The NFM-P backs up the Oracle encryption wallet during a database backup, and restores the wallet during a database restore. In a redundant deployment, the NFM-P automatically replicates the encryption wallet from the primary to the standby database after the standby database reinstatement.



Note: During a database backup, the performance of GUI or XML API operations may be affected. It is recommended that you schedule the database backup to occur during a period of low NFM-P activity.

22.14.1 Steps

1

Choose Administration→Database from the NFM-P menu. The Database Manager form (Edit) opens.

2

Click on the Backup tab.

3

Configure the required parameters in the Backup Schedule panel.



Note: You must select the Schedule Enabled parameter.

4



CAUTION

Data Loss

Before the NFM-P performs a database backup, it deletes the contents of the specified backup directory.

Ensure that the backup directory that you specify in this step does not contain files that you need to retain.

Configure the Scheduled Backup Directory parameter in the Backup Setting panel. The value that you specify is the database station directory in which to save the backup file sets. Each file set is stored in a subdirectory named backupset*n*, where *n* is a sequential number; the highest possible value is the Number to Keep parameter value.



Note: The Oracle management user requires read and write permissions on the backup directory. The user and group names are specified during database installation; the default is 'oracle' in the 'dba' group.



Note: The Scheduled Backup Directory must be a directory on the local file system.

5

Close the Database Manager form.

6

After each scheduled database backup completes, move the database backup file set to another station for safekeeping.

The database backup creates the following summary file in the same directory as the backup files:

BACKUP_SUMMARY.INFO

The summary file contains detailed backup information that includes the backup completion time, and the name and size of each backup file.

END OF STEPS

22.15 How do I restore a standalone main database?

22.15.1 Purpose

The following steps describe how to restore a standalone main database using a backup file set. You require the following:

- a database backup file set from the same NFM-P release
- the original file path of the database backup



Note: You require the following user privileges:

- main server — root, nsp
- main database — root, Oracle management user

i **Note:** The Oracle management user requires read and write permissions on the backup directory. The user and group names are specified during database installation; the default is 'oracle' in the 'dba' group.

22.15.2 Steps

1

If the database backup file set is on the database station, copy the file set to a different station for safekeeping.

2

Perform the following steps to stop the main server.

1. Log in to the main server station as the nsp user.
2. Open a console window.
3. Enter the following:

```
bash$ cd /opt/nsp/nfmp/server/nms/bin ↵
```

4. Enter the following to stop the main server:

```
bash$ ./nmserver.bash stop ↵
```

5. Enter the following to display the NFM-P server status:

```
bash$ ./nmserver.bash appserver_status ↵
```

The server status is displayed; the server is fully stopped if the status is the following:

```
Application Server is stopped
```

If the server is not fully stopped, wait five minutes and then repeat this step. Do not perform the next step until the server is fully stopped.

3

Enter the following to switch to the root user:

```
bash$ su ↵
```

4

Enter the following to disable the automatic main server startup.

```
# systemctl disable nfmp-main.service ↵
```

5

If you are restoring the database on a new station, for example, if the current database station is unusable, go to [Step 10](#).

6 _____
Log in to the database station as the root user.

7 _____
Enter the following to uninstall the database:
dnf remove nsp-nfmp-main-db --setopt=clean_requirements_on_remove=false ↵
The dnf utility displays the following prompt:
Installed size: *nn* G
Is this ok [y/N]:

8 _____
Enter *y*. The following is displayed:
Downloading packages:
Running transaction check
Running transaction test
Transaction test succeeded
Running transaction
Uninstalling the NFM-P Database...
When the uninstallation is complete, the following is displayed:
Complete!

9 _____
When the uninstallation is complete, enter the following to reboot the database station:
systemctl reboot ↵
The station reboots.

10 _____
Log in as the root user on the database station.

11 _____
Open a console window.

12 _____
Remove any files in the `/opt/nsp/nfmp/db/tablespace` and `/opt/nsp/nfmp/db/archivelog` directories.

13 _____
Copy the database backup file set to the station.

i **Note:** The path to the backup file set must be the same as the path to the file set at creation time.

14

Perform one of the following.

a. If you are restoring the database on the same station, download or copy the following NFM-P installation files for the existing release to an empty directory on the database station:

- `nsp-nfmp-main-db-R.r.p-rel.v.rpm`
- `OracleSw_PreInstall.sh`

b. If you are restoring the database on a new station, for example, if the current database station is unusable, download or copy the following NFM-P installation files for the existing release to an empty directory on the database station:

- `nsp-nfmp-jre-R.r.p-rel.v.rpm`
- `nsp-nfmp-config-R.r.p-rel.v.rpm`
- `nsp-nfmp-oracle-R.r.p-rel.v.rpm`
- `nsp-nfmp-main-db-R.r.p-rel.v.rpm`
- `OracleSw_PreInstall.sh`

where

R.r.p is the NSP release identifier, in the form *MAJOR.minor.patch*

v is a version identifier

15

Navigate to the directory that contains the NFM-P installation files.

i **Note:** Ensure that the directory contains only the installation files.

16

Enter the following:

```
# chmod +x * ↵
```

17

Enter the following:

```
# ./OracleSw_PreInstall.sh ↵
```

i **Note:** The default values displayed by the script are shown as *[default]*. To accept a default value, press ↵.

The following prompt is displayed:

```
This script will prepare the system for a new install/restore of  
an NFM-P Version R.r Rn database.
```

```
Do you want to continue? [Yes/No]:
```

18

Enter Yes. The following prompt is displayed:

```
Enter the Oracle dba group name [group]:
```

19

Enter a group name and press ↵.

i **Note:** To reduce the complexity of subsequent software upgrades and technical support activities, it is recommended that you accept the default.

The following message is displayed:

```
Creating group group if it does not exist...
```

If you specify a new group, the following message is displayed:

```
done
```

20

If you specify an existing group, the following prompt is displayed:

```
WARNING: Group group already exists locally.
```

```
Do you want to use the existing group? [Yes/No]:
```

Perform one of the following.

- a. Enter Yes ↵.
- b. Enter No ↵. Go to [Step 19](#).

21

If the default user exists in the specified group, the following prompt is displayed:

```
The user [username] for the group [group] already exists locally.
```

```
Do you want to use the existing user? [Yes/No]:
```

22

Perform one of the following.

a. Enter Yes ↵; the following messages are displayed:

```
Checking or Creating the Oracle user home directory  
/opt/nsp/nfmp/oracle19...
```

```
Checking user username...
```

```
WARNING: Oracle user with the specified name already exists locally.
```

```
Redefining the primary group and home directory of user username ...  
usermod: no changes
```

```
Changing ownership of the directory /opt/nsp/nfmp/oracle19 to  
username:group.
```

```
About to unlock the UNIX user [username]
```

```
Unlocking password for user username
passwd: Success Unlocking the UNIX user [username] completed
```

- b. Enter No ↵. The following prompt is displayed:

```
Enter the Oracle user name:
Type a username and press ↵.
The following messages and prompt are displayed:
Oracle user [username] new home directory will be
[/opt/nsp/nfmp/oracle19].
Checking or Creating the Oracle user home directory
/opt/nsp/nfmp/oracle19..
Checking user username...
Adding username...
Changing ownership of the directory /opt/nsp/nfmp/oracle19 to
username:group.
About to unlock the UNIX user [username]
Unlocking password for user username.
passwd: Success
Unlocking the UNIX user [username] completed
Please assign a password to the UNIX user username ..
New Password:
```

23

Perform one of the following.

- a. If you specify a new user in [Step 22](#) , the following prompt is displayed:

```
Please assign a password to the UNIX user username ..
New Password:
```

Perform the following steps.

1. Type a password and press ↵. The following prompt is displayed:

```
Re-enter new Password:
```

2. Retype the password and press ↵. The following message is displayed if the password update is successful:

```
passwd: password successfully changed for username
```

- b. If you specify an existing user in [Step 22](#) , the following prompt is displayed:

```
Do you want to change the password for the UNIX user username?
[Yes/No]:
Type No ↵.
```

24

The following prompt is displayed:

Specify whether an NFM-P server will be installed on this workstation. The database memory requirements will be adjusted to account for the additional load.

Will the database co-exist with an NFM-P server on this workstation [Yes/No]:

Enter Yes or No, as required, and press ↵.

Messages like the following are displayed as the script execution completes:

```
INFO: About to set kernel parameters in /etc/sysctl.conf...
INFO: Completed setting kernel parameters in /etc/sysctl.conf...
INFO: About to change the current values of the kernel parameters
INFO: Completed changing the current values of the kernel parameters
INFO: About to set ulimit parameters in /etc/security/limits.conf...
INFO: Completed setting ulimit parameters in /etc/security/limits.conf...
INFO: Completed running Oracle Pre-Install Tasks
```

25

When the script execution is complete, enter the following to reboot the database station:

```
# systemctl reboot ↵
```

The station reboots.

26

When the reboot is complete, log in as the root user on the database station.

27

Navigate to the directory that contains the NFM-P installation files.

28

Perform one of the following:

a. If you are restoring the database on the same station, enter the following:

```
# dnf install nsp-nfmp-main-db* ↵
```

b. If you are restoring the database on a new station, enter the following:

```
# dnf install *.rpm ↵
```

The dnf utility resolves any package dependencies, and displays the following prompt:

```
Total size: nn G
```

```
Installed size: nn G
```

```
Is this ok [y/d/N]:
```

29

Enter `y`. The following and the installation status are displayed as each package is installed:

```
Downloading packages:
Running transaction check
Running transaction test
Transaction test succeeded
Running transaction
```

The package installation is complete when the following is displayed:

```
Complete!
```

30

Enter the following:

```
# samrestoreDb path ↵
```

where *path* is the absolute path of the directory that contains the database backup file set

The database restore begins.

If the backup file set has been created using file compression, messages like the following are displayed.

```
About to uncompress backup files under path
Completed uncompressing backup files under path
```

Messages like the following are displayed as the restore progresses.

```
Restore log is /opt/nsp/nfmp/db/install/NFM-P_Main_Database.restore.
yyyymm.dd-hh.mm.ss.stdout.txt
<date time> working..
<date time> Performing Step 1 of 7 - Initializing ..
<date time> Executing StartupDB.sql ...
<date time> Performing Step 2 of 7 - Extracting backup files .....
<date time> Performing Step 3 of 7 - Restoring archive log files ..
<date time> Performing Step 4 of 7 - Executing restore.rcv .....
<date time> Performing Step 5 of 7 - Restoring Accounting tablespaces
.....
<date time> Performing Step 6 of 7 - Opening database .....
<date time> working....
<date time> Executing ConfigRestoreDB.sql .....
<date time> working.....
<date time> Performing Step 7 of 7 - Configuring SAM Server settings
...
```

The restore is complete when the following is displayed:

```
<date time> Database restore was successful
```

DONE

31

Log in to the main server station as the root user.

32

Enter the following to enable the automatic main server startup.

```
# systemctl enable nfmp-main.service ↵
```

33

Start the main server.

1. Enter the following to switch to the nsp user:

```
# su - nsp ↵
```

2. Enter the following:

```
bash$ /opt/nsp/nfmp/server/nms/bin/nmserver.bash start ↵
```

The main server starts.

34

Close the open console windows, as required.

35

Perform a full network resynchronization to discover the interim changes in the managed network.

END OF STEPS

22.16 How do I restore the primary main database in a redundant system?

22.16.1 Purpose

The following steps describe how to restore the primary main database in a redundant NFM-P system using a backup file set created on the same station. The station is called the primary database station in the procedure.

To regain main database redundancy after a database restore, you must reinitiate the primary database on the standby database station. See [22.20 “How do I reinitiate the main database from the client GUI?” \(p. 680\)](#) and [22.21 “How do I reinitiate the main database from a CLI?” \(p. 681\)](#) for information.

You require the following:

- a main database backup file set from the same NFM-P release
- the original file path of the database backup

-
- i** **Note:** You require the following user privileges:
- main server — root, nsp
 - main database — root, Oracle management user

- i** **Note:** The Oracle management user requires read and write permissions on the backup directory. The user and group names are specified during database installation; the default is 'oracle' in the 'dba' group.

22.16.2 Steps

- 1 _____
If the database backup file set is on the primary database station, copy the file set to a different station for safekeeping.
- 2 _____
Stop the standby main server.
 1. Log in to the standby main server station as the nsp user.
 2. Open a console window.
 3. Enter the following:

```
bash$ cd /opt/nsp/nfmp/server/nms/bin ↵
```
 4. Enter the following:

```
bash$ ./nmserver.bash stop ↵
```
 5. Enter the following to display the server status:

```
bash$ ./nmserver.bash appserver_status ↵
```

The server status is displayed; the server is fully stopped if the status is the following:
Application Server is stopped

If the server is not fully stopped, wait five minutes and then repeat this step. Do not perform the next step until the server is fully stopped.
- 3 _____
Enter the following to switch to the root user:

```
bash$ su ↵
```
- 4 _____
Enter the following to disable the automatic main server startup.

```
# systemctl disable nfmp-main.service ↵
```
- 5 _____
Stop the standby database:
 1. Log in to the standby database station as the root user.
 2. Open a console window.

-
3. Enter the following to stop the Oracle proxy:

```
# systemctl stop nfmp-oracle-proxy.service ↵
```
 4. Enter the following to stop the database:

```
# systemctl stop nfmp-main-db.service ↵
```

6

Stop the primary main server.

1. Log in to the primary main server station as the nsp user.
2. Open a console window.
3. Enter the following:

```
bash$ cd /opt/nsp/nfmp/server/nms/bin ↵
```

4. Enter the following:

```
bash$ ./nmserver.bash stop ↵
```

5. Enter the following to display the server status:

```
bash$ ./nmserver.bash appserver_status ↵
```

The server status is displayed; the server is fully stopped if the status is the following:

```
Application Server is stopped
```

If the server is not fully stopped, wait five minutes and then repeat this step. Do not perform the next step until the server is fully stopped.

7

Enter the following to switch to the root user:

```
bash$ su ↵
```

8

Enter the following to disable the automatic main server startup.

```
# systemctl disable nfmp-main.service ↵
```

9

If you are restoring the database on a new station, for example, if the current primary database station is unusable, go to [Step 15](#).

10

Log in to the primary database station as the root user.

11

Open a console window.

12

Enter the following to uninstall the primary database:

```
# dnf remove nsp-nfmp-main-db --setopt=clean_requirements_on_remove=  
false ↵
```

The dnf utility displays the following prompt:

```
Installed size: nn G
```

```
Is this ok [y/N]:
```

13

Enter y. The following is displayed:

```
Downloading packages:
```

```
Running transaction check
```

```
Running transaction test
```

```
Transaction test succeeded
```

```
Running transaction
```

```
Uninstalling the NFM-P Database...
```

When the uninstallation is complete, the following is displayed:

```
Complete!
```

14

When the uninstallation is complete, enter the following to reboot the primary database station:

```
# systemctl reboot ↵
```

The station reboots.

15

Log in as the root user on the primary database station.

16

Open a console window.

17

Remove any files in the /opt/nsp/nfmp/db/tablespace and /opt/nsp/nfmp/db/archivelog directories.

18

Copy the database backup file set to the primary database station.

 **Note:** The path to the backup file set must be the same as the path to the file set at creation time.

19

If you are restoring the database on a new station, for example, if the current primary database station is unusable, download or copy the following files for the installed NFM-P release to an empty directory on the database station:

- nsp-nfmp-jre-*R.r.p-rel.v*.rpm
- nsp-nfmp-config-*R.r.p-rel.v*.rpm
- nsp-nfmp-oracle-*R.r.p-rel.v*.rpm
- nsp-nfmp-main-db-*R.r.p-rel.v*.rpm
- OracleSw_PreInstall.sh

where

R.r.p is the NSP release identifier, in the form *MAJOR.minor.patch*

v is a version identifier

20

Navigate to the directory that contains the NFM-P installation files.

21

Enter the following:

```
# chmod +x * ↵
```

22

Enter the following:

```
# ./OracleSw_PreInstall.sh ↵
```

i **Note:** The default values displayed by the script are shown as *[default]*. To accept a default value, press ↵.

The following prompt is displayed:

```
This script will prepare the system for a new install/restore of  
an NFM-P Version R.r Rn database.
```

```
Do you want to continue? [Yes/No]:
```

23

Enter Yes. The following prompt is displayed:

```
Enter the Oracle dba group name [group]:
```

24

Enter a group name and press ↵.

i **Note:** To reduce the complexity of subsequent software upgrades and technical support activities, it is recommended that you accept the default.

The following message is displayed:

```
Creating group group if it does not exist...
```

If you specify a new group, the following message is displayed:

```
done
```

25

If you specify an existing group, the following prompt is displayed:

```
WARNING: Group group already exists locally.
```

```
Do you want to use the existing group? [Yes/No]:
```

Perform one of the following.

- a. Enter Yes ↵.
- b. Enter No ↵. Go to [Step 24](#) .

26

If the default user exists in the specified group, the following prompt is displayed:

```
The user [username] for the group [group] already exists locally.
```

```
Do you want to use the existing user? [Yes/No]:
```

27

Perform one of the following.

- a. Enter Yes ↵; the following messages are displayed:

```
Checking or Creating the Oracle user home directory  
/opt/nsp/nfmp/oracle19...
```

```
Checking user username...
```

```
WARNING: Oracle user with the specified name already exists locally.
```

```
Redefining the primary group and home directory of user username ...  
usermod: no changes
```

```
Changing ownership of the directory /opt/nsp/nfmp/oracle19 to  
username:group.
```

```
About to unlock the UNIX user [username]
```

```
Unlocking password for user username
```

```
passwd: Success
```

```
Unlocking the UNIX user [username] completed
```

- b. Enter No ↵. The following prompt is displayed:

```
Enter the Oracle user name:
```

Type a username and press ↵.

The following messages and prompt are displayed:

```
Oracle user [username] new home directory will be  
[/opt/nsp/nfmp/oracle19].
```

```
Checking or Creating the Oracle user home directory  
/opt/nsp/nfmp/oracle19..
```

```
Checking user username...
Adding username...
Changing ownership of the directory /opt/nsp/nfmp/oracle19 to
username:group.
About to unlock the UNIX user [username]
Unlocking password for user username.
passwd: Success
Unlocking the UNIX user [username] completed
Please assign a password to the UNIX user username ..
New Password:
```

28

Perform one of the following.

- a. If you specify a new user in [Step 27](#) , the following prompt is displayed:

```
Please assign a password to the UNIX user username ..
New Password:
```

Perform the following steps.

1. Type a password and press ↵. The following prompt is displayed:

```
Re-enter new Password:
```

2. Retype the password and press ↵. The following message is displayed if the password update is successful:

```
passwd: password successfully changed for username
```

- b. If you specify an existing user in [Step 27](#) , the following prompt is displayed:

```
Do you want to change the password for the UNIX user username?
[Yes/No]:
```

Type No ↵.

29

The following prompt is displayed:

```
Specify whether an NFM-P server will be installed on this workstation.
The database memory requirements will be adjusted to account for the
additional load.
```

```
Will the database co-exist with an NFM-P server on this workstation
[Yes/No]:
```

Enter Yes or No, as required, and press ↵.

Messages like the following are displayed as the script execution completes:

```
INFO: About to set kernel parameters in /etc/sysctl.conf...
INFO: Completed setting kernel parameters in /etc/sysctl.conf...
INFO: About to change the current values of the kernel parameters
```

```
INFO: Completed changing the current values of the kernel parameters
INFO: About to set ulimit parameters in /etc/security/limits.conf...
INFO: Completed setting ulimit parameters in /etc/security/limits.conf...
INFO: Completed running Oracle Pre-Install Tasks
```

30

When the script execution is complete, enter the following to reboot the database station:

```
# systemctl reboot ↵
```

The station reboots.

31

When the reboot is complete, log in as the root user on the primary database station.

32

Navigate to the directory that contains the NFM-P installation files.

33

Perform one of the following:

a. If you are restoring the database on the same station, enter the following:

```
# dnf install nsp-nfmp-main-db* ↵
```

b. If you are restoring the database on a new station, enter the following:

```
# dnf install *.rpm ↵
```

The dnf utility resolves any package dependencies, and displays the following prompt:

```
Total size: nn G
```

```
Installed size: nn G
```

```
Is this ok [y/d/N]:
```

34

Enter *y*. The following and the installation status are displayed as each package is installed:

```
Downloading packages:
```

```
Running transaction check
```

```
Running transaction test
```

```
Transaction test succeeded
```

```
Running transaction
```

The package installation is complete when the following is displayed:

```
Complete!
```

35

If the backup set is compressed as a tar file, you can obtain the absolute path of the database backup file set from the BACKUP_SUMMARY.INFO file. Perform the following to extract the BACKUP_SUMMARY.INFO file from the tar file:

```
# tar -xvf path BACKUP_SUMMARY.INFO
```

where *path* is the absolute path of the compressed database backup file

36

Perform one of the following.

a. If you are restoring the primary database on the same station, enter the following:

```
# samrestoreDb path ↵
```

where *path* is the absolute path of the directory that contains the database backup file set

b. If you are restoring the database on a new primary database station, enter the following:

```
# samrestoreDb path -standbyinstance instance -standbyip IP_address ↵
```

where

path is the absolute path of the directory that contains the database backup file set

instance is the standby database instance name

IP_address is the standby database IP address

The database restore begins.

If the backup file set has been created using file compression, messages like the following are displayed.

```
About to uncompress backup files under path
```

```
Completed uncompressing backup files under path
```

Messages like the following are displayed as the restore progresses.

```
Restore log is /opt/nsp/nfmp/db/install/NFM-P_Main_Database.restore.  
yyyy.mm.dd-hh.mm.ss.stdout.txt
```

```
<date time> working..
```

```
<date time> Performing Step 1 of 7 - Initializing ..
```

```
<date time> Executing StartupDB.sql ...
```

```
<date time> Performing Step 2 of 7 - Extracting backup files .....
```

```
<date time> Performing Step 3 of 7 - Restoring archive log files ..
```

```
<date time> Performing Step 4 of 7 - Executing restore.rcv .....
```

```
<date time> Performing Step 5 of 7 - Restoring Accounting tablespaces  
.....
```

```
<date time> Performing Step 6 of 7 - Opening database .....
```

```
<date time> working....
```

```
<date time> Executing ConfigRestoreDB.sql .....
```

```
<date time> working.....  
<date time> Performing Step 7 of 7 - Configuring SAM Server settings  
...  
The following is displayed when the restore is complete:  
<date time> Database restore was successful  
DONE
```

37

When the database restore is complete, close the console window.

38

Log in to the primary main server station as the root user.

39

Enter the following to enable the automatic main server startup:

```
# systemctl enable nfmp-main.service ↵
```

40

Start the primary main server.

1. Enter the following to switch to the nsp user

```
# su - nsp ↵
```

2. Enter the following:

```
bash$ cd /opt/nsp/nfmp/server/nms/bin ↵
```

3. Enter the following:

```
bash$ ./nmserver.bash start ↵
```

4. Enter the following to display the server status:

```
bash$ ./nmserver.bash appserver_status ↵
```

The server status is displayed; the server is fully initialized if the status is the following:

```
Application Server process is running. See nms_status for more  
detail.
```

If the server is not fully initialized, wait five minutes and then repeat this step. Do not perform the next step until the server is fully initialized.

41

Perform a full resynchronization of the network to discover the interim changes in the managed network.

42

Start the standby database.

1. Log in to the standby main database station as the root user.

-
2. Enter the following to start the Oracle proxy:
`systemctl start nfmp-oracle-proxy.service` ↵
 3. Enter the following to start the database:
`systemctl start nfmp-main-db.service` ↵

43

Log in to the standby main server station as the root user.

44

Enter the following to enable the automatic main server startup:

```
# systemctl enable nfmp-main.service ↵
```

45

Start the standby main server.

1. Enter the following to switch to the nsp user
`su - nsp` ↵
2. Enter the following:
bash\$ `cd /opt/nsp/nfmp/server/nms/bin` ↵
3. Enter the following:
bash\$ `./nmserver.bash start` ↵
4. Enter the following to display the server status:
bash\$ `./nmserver.bash appserver_status` ↵

The server status is displayed; the server is fully initialized if the status is the following:
Application Server process is running. See `nms_status` for more detail.

If the server is not fully initialized, wait five minutes and then repeat this step. Do not perform the next step until the server is fully initialized.

46

To restore the database redundancy, reinstantiate the primary database on the standby database station, as described in [22.20 “How do I reinstantiate the main database from the client GUI?”](#) (p. 680) or [22.21 “How do I reinstantiate the main database from a CLI?”](#) (p. 681).

END OF STEPS

22.17 How do I delete the inactive residential subscriber instances?

22.17.1 Purpose

It is recommended that you periodically remove the inactive subscriber instance records from the NFM-P main database. A subscriber instance becomes inactive when the associated subscriber is deleted from an NE. The inactive instances accumulate rapidly, for example, in a Wi-Fi offload deployment.

Perform this procedure to configure and execute a script that removes the inactive subscriber instance records from the main database.

i **Note:** Before you perform the procedure, it is recommended that you disable the GUI client timeout so that you can use the client GUI to monitor the script execution. Otherwise, if the execution takes longer than the GUI client timeout, you can monitor the script execution using the NFM-P user activity log.

22.17.2 Steps

Disable GUI client timeout

- 1 _____
Choose Administration→Security→NFM-P User Security from the NFM-P main menu. The NFM-P User Security — Security Management (Edit) form opens.
- 2 _____
Set the Client Timeout (minutes) parameter to 0, which specifies no timeout.
- 3 _____
Save your changes and close the form.

Configure a script bundle

- 4 _____
Choose Tools→Scripts from the NFM-P main menu. The Scripts form opens.
- 5 _____
Choose Script Bundle (Scripting) from the drop-down menu and click Search. A list of script bundles is displayed.
- 6 _____
If a subscriber instance deletion script bundle is listed, go to [Step 12](#).
- 7 _____
Click Browse Examples. The Browse Examples of Scripts form opens.

8 _____
Navigate to the required bundle example. The path is Script Bundle
Examples→Miscellaneous→Remove Inactive Residential Subscriber Instances Bundle.

9 _____
Select the bundle example and click Create Bundle. The Script Bundle (Create) form opens.

10 _____
Configure the Name parameter.

11 _____
Save your changes and close the forms.

Execute the script bundle

12 _____
Select the script bundle in the Scripts form and click Properties. The Script Bundle (Edit) form opens.

13 _____
Select Remove Residential Subscriber CTL and click Execute Script. The Execute Script form opens.

14 _____
Configure the parameter on the form to specify the number of days of inactivity that qualify a subscriber instance for deletion.

 **Note:** If the NFM-P forwards statistics or billing information to NSP Analytics, ensure that the parameter value is greater than the billing period in days to ensure that no inactive subscriber instances are deleted before the billing occurs.

15 _____
Click Execute. The script execution begins.
While the script runs, a new item with an hourglass symbol is displayed in the navigation panel on the left side of the form. When the script execution is complete, the symbol changes to a green check mark.

16 _____
Close all forms.

17

If required, restore the GUI client timeout to its original value.

END OF STEPS

22.18 How do I export an NFM-P main database?

22.18.1 Purpose

Perform this procedure to export the main database content to a file set.

You require the following user privileges:

- on each main server station — root
- on the standalone or primary main database station:
 - root
 - Oracle database user — password initially set as the user-password value in the database section of samconfig
 - Oracle management user — user name specified during database installation; default is 'oracle'
 - Oracle SYS user — default password available from technical support



CAUTION

Service Disruption

A database export operation requires a shutdown of each main server, which causes a network management outage.

You must perform this procedure only during a scheduled maintenance period.



Note: The passwords that you enter in the procedure are not displayed.

22.18.2 Steps

General preparation

1

Clear all outstanding failed deployments. See “To view and manage failed deployments” in the *NSP NFM-P User Guide* for information about how to clear a failed deployment.

2

Obtain the following main database information; in a redundant deployment, you require the primary database information:

- Oracle database instance name—default is samdb1
- Oracle database user password—set initially as the user-password value in the database section of samconfig on the standalone or primary main server

- Oracle SYS user password—default available from technical support

Stop main servers

3

Perform the following steps on each main server station to stop the main server.

i **Note:** In a redundant deployment, you must stop the standby main server first.

1. Log in to the main server station as the nsp user.
2. Open a console window.
3. Enter the following:

```
bash$ cd /opt/nsp/nfmp/server/nms/bin ↵
```

4. Enter the following to stop the main server:

```
bash$ ./nmserver.bash stop ↵
```

5. Enter the following to display the main server status:

```
bash$ ./nmserver.bash appserver_status ↵
```

The server status is displayed; the server is fully stopped if the status is the following:

```
Application Server is stopped
```

If the server is not fully stopped, wait five minutes and then repeat this step. Do not perform the next step until the server is fully stopped.

Run database export script

4

Log in to the main database station as the Oracle management user.

5

Open a console window.

6

If the directory that is to hold the database export file set does not exist, create the directory.

i **Note:** The database export operation fails if the directory that is to contain the exported database file set does not exist.

The directory must be a directory on the local file system to which the Oracle management user has read/write access.

7

Enter the following:

```
bash$ /opt/nsp/nfmp/db/install/config/samdb/SAMDb_exportImport.sh -e  
destination ↵
```

where *destination* is the absolute path of the directory that is to hold the database file set

i **Note:** To display the script usage, specify the -h option, as follows:
`SAMDb_exportImport.sh -h ↵`

The following messages and prompt are displayed:

```
Using DB_INSTALL_BASE = /opt/nsp/nfmp/db/install
```

```
Using ORACLE_SID = maindb1
```

```
Using ORACLE_HOME = /opt/nsp/nfmp/oracle19
```

```
Enter the password for the "sys" user (terminal echo is off):
```

8

Enter the Oracle SYS user password and press ↵.

The following prompt is displayed:

```
Enter the password for database_user (terminal echo is off):
```

9

Enter the Oracle database user password and press ↵.

The following prompt is displayed:

```
Enter the export encryption password (terminal echo is off):
```

10

Create and record a database export encryption password. The password is required for a subsequent database import operation.

i **Note:** The password can be of any length and use any characters.

11

Type the created password and press ↵.

The following prompt is displayed:

```
Confirm export encryption password (terminal echo is off):
```

12

Retype the password and press ↵.

The following message and prompt are displayed:

```
This tool will shutdown the db listener disconnecting any connections  
to the database.
```

```
Have the SAM servers been shutdown? [y/n/q] (y):
```

13

Press ↵.

The following message and prompt are displayed:

```
To optimize the speed of the export this script will use as many CPUs  
as you allow it to.
```

```
The maximum number of CPUs available are n
How many CPUs will be used for this export? (1):
```

14

Type the number of CPUs to use for the export operation, and press ↵.

The following prompt is displayed:

```
Do you want to perform an export size estimate first? [y/n/q] (y):
```

15

Press ↵ to direct the script to estimate the amount of disk space that the export requires.

The script displays an estimate of the required disk space, the available space in the partition that contains the destination directory, and the following prompt:

```
Do you have enough space? [y/n/q] (n):
```

16

Perform one of the following.

a. Confirm the space requirement and proceed with the export.

1. Type y ↵ if the partition has sufficient capacity to hold the exported file set.

The following prompt is displayed:

```
Proceed with the export? [y/n/q] (y):
```

2. Press ↵. The database export begins.

The script displays information that includes the export log filename and a series of progress indicators.

b. Press ↵ if the partition lacks sufficient capacity to hold the exported file set.

The following message is displayed and the script exits:

```
Cancelling export...
```

17

Close the open console windows, as required.

END OF STEPS

22.19 How do I import an NFM-P main database?

22.19.1 Purpose

Perform this procedure to import a main database from an exported file set.

You require the following user privileges:

- on each main server station — root
- on the standalone or primary main database station:
 - root

- Oracle database user — password initially set as the user-password value in the database section of samconfig
- Oracle management user — user name specified during database installation; default is 'oracle'
- Oracle SYS user — default password available from technical support



CAUTION

Service Disruption

A database import operation requires a shutdown of each main server, which causes a network management outage.

You must perform this procedure only during a scheduled maintenance period.



Note: The passwords that you enter in the procedure are not displayed.

22.19.2 Steps

Stop main servers

1

Perform the following steps on each main server station to stop the main server.



Note: In a redundant deployment, you must stop the standby main server first.

1. Log in to the main server station as the nsp user.
2. Open a console window.
3. Enter the following:

```
bash$ cd /opt/nsp/nfmp/server/nms/bin ↵
```

4. Enter the following to stop the main server:

```
bash$ ./nmserver.bash stop ↵
```

5. Enter the following to display the main server status:

```
bash$ ./nmserver.bash appserver_status ↵
```

The server status is displayed; the server is fully stopped if the status is the following:

```
Application Server is stopped
```

If the server is not fully stopped, wait five minutes and then repeat this step. Do not perform the next step until the server is fully stopped.

Install database

2

You can perform a main database import only on a station that has a newly installed main database; perform one of the following.

- a. If the station on which you are performing the import hosts a main database that is not newly installed, uninstall the database, as described in the *NSP Installation and Upgrade Guide*.
- b. If the station on which you are performing the import has no main database installed, install a main database on the station, as described in the *NSP Installation and Upgrade Guide*.

Run database import script

3

Copy the exported database file set to the database station.



Note: The directory to which you copy the file set must contain no other files. The directory must be a directory on the local file system to which the Oracle management user has read/write access.

4

Log in to the database station as the Oracle management user.

5

Open a console window.

6

Enter the following:

```
bash$ /opt/nsp/nfmp/db/install/config/samdb/SAMDb_exportImport.sh -i  
source ↵
```

where *source* is the absolute path of the directory that contains the exported database file set



Note: To display the script usage, specify the `-h` option, as follows:

```
SAMDb_exportImport.sh -h ↵
```

The following messages and prompt are displayed:

```
Using DB_INSTALL_BASE = /opt/nsp/nfmp/db/install
```

```
Using ORACLE_SID = maindb1
```

```
Using ORACLE_HOME = /opt/nsp/nfmp/oracle19
```

```
Enter the password for the "sys" user (terminal echo is off):
```

7

Enter the Oracle SYS user password and press ↵.

The following prompt is displayed:

```
Enter the password for database_user (terminal echo is off):
```

8

Enter the Oracle database user password and press ↵.

The following prompt is displayed:

Enter the export encryption password (terminal echo is off):

9

Enter the database export encryption password created during the database export operation.

The following messages and prompt are displayed:

In order to optimize the speed of this import, this script needs to know how many CPUs are available on this machine and how many data files there are to import.

This machine appears to have *n* CPUs

Is this correct? [y/n/q] (y):

10

Type the number of CPUs to use for the export operation, and press ↵.

The following message and prompt are displayed:

There appears to be *n* data files to import Is this correct? [y/n/q] (y):

11

Press ↵ if the number of data files to import is correct.

The following message and prompt are displayed:

Log of import command will be written to *log_file*

Proceed with the import? [y/n/q] (y):

12

Press ↵ to proceed with the database import.

The script generates messages like the following as it begins to import the database.

Adding addition datafiles to existing tablespacesRestore wallet file

Restarting the database...

Shutting down the listener

Starting import: *timestamp*

where *timestamp* is the start time of the import operation

The script displays a series of progress indicators.

The following messages are displayed when the import operation is complete:

Executing recreate TI_BULK* packages body

Import done: *timestamp*

Starting up the listener

Here is the import log: *log_file*

where

log_file is the name of a log file that the script creates

timestamp is the start time of the import operation

13

Close the open console windows, as required.

END OF STEPS

22.20 How do I reinstantiate the main database from the client GUI?

22.20.1 Purpose

Perform this procedure to use the NFM-P GUI to restore the main database redundancy in a redundant NFM-P system by reinstantiating the primary main database on the standby database station. Database reinstatement is required after a main database failure.

If automatic database reinstatement is enabled, a failed manual reinstatement attempt does not affect the reinstatement timer. If a manual reinstatement is successful, the NFM-P does not attempt a subsequent reinstatement.

Before you attempt to perform this procedure, the following conditions must be true:

- The primary database proxy and the standby database proxy are in contact with the primary main server.
- The database listener is operating.

22.20.2 Steps

1

Log in to a GUI client as a user that has an assigned Administrator scope of command role.

2

Choose Administration→System Information from the NFM-P main menu. The System Information form opens.

3

If you are performing this procedure after a database failover or switchover, ensure that the Failover State or Switchover State on the form is Successful.



Note: The state must read Successful before you can continue.

4

Click Re-Instantiate Standby, and then click Yes. The database reinstatement begins.



Note: The Re-Instantiate Standby button is displayed only if your user account has an appropriate scope of command.

The client GUI status bar and the System Information form display the reinstatement status. The Standby Re-instantiation State changes from In Progress to Success when the

reinstantiation is complete. The Last Attempted Standby Re-instantiation Time displays the start time of the current reinitiation.

5

When the reinitiation is complete, close the System Information form.

6

View the NFM-P GUI status bar to verify that the NFM-P main servers and main database are communicating and operational.

END OF STEPS

22.21 How do I reinitiate the main database from a CLI?

22.21.1 Purpose

Perform this procedure to use a CLI to restore the main database redundancy in a redundant NFM-P system by reinitiating the primary main database on the standby database station. Database reinitiation is required after a main database failure.

If automatic database reinitiation is enabled, a failed manual reinitiation attempt does not affect the reinitiation timer. If a manual reinitiation is successful, the NFM-P does not attempt a subsequent reinitiation.

Before you attempt to perform this procedure, the following conditions must be true:

- The primary database proxy and the standby database proxy are in contact with the primary main server.
- The database listener is operating.

 **Note:** You require nsp user privileges on the primary main server station.

22.21.2 Steps

1

Log in to the primary main server station as the nsp user.

2

Open a console window.

3

Navigate to the /opt/nsp/nfmp/server/nms/bin directory.

4

Enter the following:

```
bash$ ./reinstantiatedb.bash -u username -p password ↵
```

where

username is the name of an NFM-P user account that has an assigned Administrator scope of command role

password is the password for the user account

The following prompt is displayed:

```
This action will rebuild the standby database.
```

```
Do you want to proceed? (YES/no) :
```

5

Enter the following:

YES ↵

The NFM-P begins to reinitiate the main database on the standby main database station. Progress is indicated by a rolling display of dots in the console window. The reinitiation is complete when the CLI prompt reappears.

6

When the reinitiation is complete, close the console window.

7

Open an NFM-P GUI client.

8

View the NFM-P GUI status bar to verify that the NFM-P main servers and main database are communicating and operational.

END OF STEPS

A Classic management scope of command roles and permissions

A.1 What are the predefined NFM-P scope of command profiles and roles?

A.1.1 General information

This appendix describes the predefined NFM-P scope of command profiles and roles, and the access permissions for each predefined role. Predefined scope of command profiles and roles cannot be deleted.

Table A-1 Summary of command profiles, roles, and permission information

Table	Description
Table A-2, "Predefined scope of command profiles" (p. 683)	Lists the predefined scope of command profiles, the assigned roles for each profile, and a description for each profile.
Table A-3, "Predefined scope of command roles" (p. 683)	Lists the NFM-P predefined scope of command roles and provides a description of the user security access provided for each role.
A.2 "What are the permissions assignable to NFM-P scope of command roles?" (p. 686)	Lists the permissions that can be assigned to an NFM-P scope of command role and a description of the permission.
A.3 "What is the permissions access for NFM-P scope of command roles?" (p. 710)	Describes the access levels that can be assigned for permissions in a scope of command role, and how to view the permission configuration of a role.

A.1.2 Predefined scope of command profiles

Table A-2 Predefined scope of command profiles

Profile name	Assigned roles	Description
admin	Administrator	Default administrative scope of command profile with access to all menus accessible from the NFM-P GUI with the exception of LI menu functions. This profile also has no XML API access.

A.1.3 Predefined scope of command roles

Table A-3 Predefined scope of command roles

Role	Access provided
Base Read-only	Read-only to all objects except for the objects in the NFM-P Security and Mirror Service Management roles.

Table A-3 Predefined scope of command roles (continued)

Role	Access provided
Administrator	GUI access, but no XML API access, to all objects. Create, modify, delete, import, and export public workspaces. View private or public workspaces in the Manage Workspaces list.
User Management	NFM-P user and group management. Create, modify, delete, import, and export public workspaces. View private or public workspaces in the Manage Workspaces list.
NFM-P Management and Operations	Database functions such as backup, restore, reinstantiation, and switchover. Alarm administration such as acknowledgement, clearing, and setting severity-change thresholds. General NE management functions such as discovery, deployment, mediation, polling, statistics management, and security management that includes modifying spans. Create, modify, delete, import, and export public workspaces. View private or public workspaces in the Manage Workspaces list.
Network Element Equipment Management	Physical equipment configuration and management.
Service Management	Service, service component, and service template management functions, excluding mirror-service management.
Old Service Template Management	Management of service templates deprecated; see Template Script Management in this table.
Subscriber Management	Customer and residential subscriber management.
QoS/ACL Policy Management	General QoS and ACL policy management, Ethernet service and time of day suite policy management.
Policy Management (except QoS/ACL)	Management of policies other than those in the QoS/ACL Policy Management role.
Routing Management	Routing protocol, L2 forwarding, and bandwidth management.
Tunnel Management	Service tunnel and underlying transport management.
NFM-P Management and Operations	Database management (Backups, Reinstantiation, and Switchovers), Alarm acknowledgement, Alarm clearing, and Severity Change Thresholds, Router administration (Scheduling, Backup Policies, Upgrade Policies, Deployment Policies, and Management Ping Policies), NE Security, LPS, and Mediation Policies, SNMP Poller/Stats Polices, Event Notification Policies, MIB Policies, SNMP Performance Statistics, Server Performance Statistics, Statistics Plotter, Usage and Activity Records, and Span configuration.
Network Element Software Management	NE software management functions.
Fault Management	Functions such as alarm management and remote network monitoring.
Service Test Management	STM functions such as creating, running and scheduling OAM tests.
Script Management	XML API and CLI script management, excluding execution.
Script Execution	XML API and CLI script execution.
Mirror Service Management	Creation and management of mirror services and mirror-service components using the GUI.

Table A-3 Predefined scope of command roles (continued)

Role	Access provided
XML API Management	Use of the XML API.
Telnet/SSH Management	Telnet or SSH access to NEs from the GUI.
CPAM Management	Route Analysis of ISIS Topology, OSPF Topology, MPLS Topology, IP Path monitoring, LSP Monitoring, Checkpoints, and Impact Analysis Scenarios for CPAM management.
CPAM OSS PCA	Route Analysis of ISIS Topology, OSPF Topology, and MPLS Topology for CPAM routing.
CPAM Topology Simulator	Route Analysis of ISIS Topology, OSPF Topology, and MPLS Topology for CPAM Topology Simulator.
Root Cause Analysis (RCA) Object Verification	RCA functions.
Lawful Interception Management	LI configuration for mirror services, mediation policies, and NE security.
Template Script Management	Service and tunnel template script management.
Service Template Script Execution	Service template script execution.
Tunnel Template Script Execution	Tunnel template script execution.
Application Assurance (AA) Management	AA policy management.
Format and Range Policy Management	Format and range policy management, service-creation span rules.
Work Order Activation	The ability to perform CM work order activation.
Configuration Snapshot Export	The ability to perform export CM configuration snapshots.
Create and Delete Access	The ability to create and/or delete eNodeB objects via the XML API
Configuration Management which causes node reset	The ability to configure objects which causes a full or partial reset of the node.
EPC Operator	Read and write permission on all Evolved Packet Core classes.
eNodeB NEM Operator	The ability to launch the 9400 NEM eNodeB parameter configuration tool.
Statistics Plotter Profile Management	Management of all Statistics Plotter profiles.
Admin Neto Launch	The ability to open the NEtO with the administration profile.
Viewer Neto Launch	The ability to open the NEtO with the viewer profile.
Default Neto Launch	The ability to open the NEtO with the null profile.
Ageout Constraint Policy Management	The ability to configure Ageout Constraint Policies.
Purge Records	The ability to purge historical records from the NFM-P such as statistics logs, event logs, etc.

A.2 What are the permissions assignable to NFM-P scope of command roles?

A.2.1 Permissions assignable to NFM-P scope of command roles

Table A-4 Permissions assigned to NFM-P scope of command roles

Package.Class.Method/Property	Description
aaa	AAA - Configurations for authentication, authorization, and accounting.
aaa.RadiusProxyInterface	RADIUS Proxy Interface - Access to Radius Proxy Interface configuration.
aaa.RadiusProxyServer	RADIUS Proxy Server - Access to Radius Proxy Server configuration.
aaa.RadiusServer	RADIUS Server - Access to Radius Server configuration.
aapolicy	Application Assurance - AA policies, configuration, protocol, group, filter, and profiles.
aapolicy.DbInfoTransitSubscriberManager.property_dbInfoTransIpAddrRtrvTimeOut	Db Info Transit Subscriber Manager - property_dbInfoTransIpAddrRtrvTimeOut - Service preferences can only be modified by a user with an administrator role.
aapolicy.DbInfoTransitSubscriberManager.property_dbInfoTransPrfxAddrRtrvTimeOut	Db Info Transit Subscriber Manager - property_dbInfoTransPrfxAddrRtrvTimeOut - Service preferences can only be modified by a user with an administrator role.
aapolicy.DbInfoTransitSubscriberManager.property_dbInfoTransSubscrRtrvMax	Db Info Transit Subscriber Manager - property_dbInfoTransSubscrRtrvMax - Service preferences can only be modified by a user with an administrator role.
accessuplink	Access Uplink - Configuration of 7210 Access Uplink Specifics for physical ports and LAG interfaces.
accounting	Accounting Policy - Statistics Accounting Policies.
aclfilter	ACL Filter Policy - MAC, IP, and IPv6 ACL Filters.
aclfilterli	ACL Filter LI - All configurations for mirroring of packets matching entries of Lawful intercept ACL filters to mirror destinations.
activation	Activation - Used to define, manage, and deploy work orders used in activation.
activation.Session	Activation Session - Used to manage activation sessions and activate work orders.
activation.Snapshot	Snapshot - Used to manage CM configuration snapshots.
activation.SnapshotEntity	Snapshot Entity - Used to manage snapshot entities.
activation.WebDAVSharedData	activation.WebDAVSharedData - Ability to restrict access to CM data (CM work orders and configuration snapshots) via the WebDAV protocol.
activation.WorkOrder	Work Order - Used to manage work orders.
aengr	Access Egress Policy - Access Egress QoS Policies.
ageoutcstr	Ageout Constraint - Configurations related to Ageout Constraint.

Table A-4 Permissions assigned to NFM-P scope of command roles (continued)

Package.Class.Method/Property	Description
aggregator	Aggregation - Aggregation Manager.
aingr	Access Ingress Policy - Access Ingress QoS Policies.
analytics	Analytics - Analytics Manager.
ancp	ANCP - Access Node Control Protocol (ANCP) policy and configuration.
ancp.AncpLoopback	ANCP Loopback - Access to ANCP Loopback tests, ANCP Loopback test definitions, and ANCP Loopback deployed tests.
antispoof	Anti-Spoofing - Anti-Spoofing for L2/L3 Access Interfaces and Filter configuration.
aosqos	AoS QoS - Quality of Service for Application over Signaling (AoS QoS) Policy and conditions, AoS QoS configuration for Physical Port and Layer 2 Bridge.
aosredundancy	AoS-Redundancy - AOS Multichassis.
aossas	AOS SAS - OAM tests specific to AOS nodes.
aossas.CPETestGroupHead	CPE SLA Test Group - Access to CPE SLA tests, CPE SLA test definitions, and CPE SLA deployed tests.
aossas.CPETestHead	CPE SLA Test - Access to CPE SLA tests, CPE SLA test definitions, and CPE SLA deployed tests.
apipe	APipe - All contained objects are listed. Package access is not currently used.
apipe.Apipe	Apipe Service - Access to VLL ATM Pipe (Apipe) Service objects themselves.
apipe.Site	Apipe Site - Access to Apipe Sites.
aps	APS - Automatic Protection Switching (APS) Groups.
arp	ARP - ARP host and configurations on service interfaces.
assurance	Assurance - Parent package for all Assurance event classes.
atm	ATM - ATM configuration for Service interfaces and routers, ATM Connections, ILMI Link, and other ATM related objects.
atm.AtmPing	ATM Ping - Access to ATM Ping tests, ATM Ping test definitions, and ATM Ping deployed tests.
atmpolicy	ATM QoS Policy - ATM Traffic Descriptor Policy.
audit	Resource Audit - Ability to execute audits and view audit results.
autoconfig	Automatic Configuration - Auto-Config Source and Target Node Profiles.
autoconfig.AutoConfigScriptManager.method_configure	Automatic Configuration - method_configure - Ability to create/modify/delete an auto-config script.
autoconfig.AutoConfigScriptManager.method_copyContents	Automatic Configuration - method_copyContents - Ability to copy the contents of one auto-config script to new one.

Table A-4 Permissions assigned to NFM-P scope of command roles (continued)

Package.Class.Method/Property	Description
bfd	BFD - Bi-Directional Forwarding Detection (BFD) can be configured on rtr.NetworkInterface, ies.L3AccessInterface, vprn.L3AccessInterface and vprn.NetworkInterface.
bgp	Routing Management: BGP - Border Gateway Protocol (BGP) configuration for routers, policies, peers, groups, MD5, and Confederations.
bgp.Site	BGP Site - Access to a BGP protocol site on a router.
bulk	Bulk Operations - Not currently used.
bulk.BulkChange	Bulk Change - The ability to create, modify, and/or delete bulk changes.
bulk.BulkManager.method_execute	Bulk Operations Manager - method_execute - The ability to execute bulk operations.
bulk.BulkManager.method_generateBatches	Bulk Operations Manager - method_generateBatches - The ability to generate batches for bulk operations.
bundle	Bundle - Bundle configuration for T1/E1 Multilink Group and channel members, APS, Multichassis and Service interfaces.
cac	CAC - CAC configuration for Physical Links, Physical Port and other CAC related objects.
ccag	CCAG - Cross-Connect Aggregation Group (CCAG) MDA card and forwarding path configuration.
cflowd	Cflowd - CFLOWD Objects.
cflowd.NeCflowd	Cflowd Configuration - Ability to configure cflowd params for SR.
cflowd.NeCollector	Cflowd Collector Configuration - Ability to configure collector for cflowd params for SR.
clear	Clear - Clear application commands and requests.
cli	CLI - Ability to connect to open NE sessions from the NFM-P.
cli.SSH	SSH Session - Ability to open an SSH Telnet session to the node from the NFM-P.
cli.Telnet	Telnet Session - Ability to open a Telnet session to the node from the NFM-P.
connprof	Connection Profile - Connection Profile configuration.
cpipe	CPipe - Access to this package is for configuring CES Interface Specifics for Cpipe specific SAPs.
cpipe.Cpipe	Cpipe Service - Access to VLL Circuit Emulation Pipe (Cpipe) Service objects themselves.
cpipe.Site	Cpipe Site - Access to Cpipe Sites.
crdtctrl	Credit Control - Credit Control configuration.
customproperties	Custom Properties - Custom properties configuration.

Table A-4 Permissions assigned to NFM-P scope of command roles (continued)

Package.Class.Method/Property	Description
db	Database - Configuration for Size constraint policies and Database file policies.
db.DatabaseManager.method_backup	Database Manager - method_backup - Ability to perform a database backup.
db.DatabaseManager.method_reinstantiateStandby	Database Manager - method_reinstantiateStandby - Ability to reinstantiate the standby database.
db.DatabaseManager.method_switchover	Database Manager - method_switchover - Ability to perform a database switchover.
dctr	Data Center - Data Center information and configurations.
dctr.PortProfile	Port Profile - Configuration of Port Profile.
dctr.VirtualSpokeSdpBinding	Virtual Spoke SDP Binding - Access to Virtual Spoke SDP Binding configuration.
dctr.VlanRange	VLAN Range - Configuration of Vlan Entry.
dctr.VplsVirtualSite	Virtual Site VPLS - Access to VPLS eVPN-Sites on a VPLS Service.
dctr.VprnVirtualSite	Virtual Site VPRN - Access to VPLS eVPN-Sites on a VPLS Service.
dhcp	DHCP - Dynamic Host Configuration Protocol (DHCP) Server for rtr.VirtualRouter and vprn.Site.
diameter	Diameter - Access to this package is for configuring Diameter related configurations, e.g. Diameter Policy.
dns	Domain Name System - Domain Name System.
dynsvc	Dynamic Services - Dynamic Services Configuration.
entity	Physical Entity Management.
epipe	EPIPE - Access to this package is for configuring CES Interface Specifics and FR Interface Specifics for Epipe specific SAPs.
epipe.Epipe	Epipe Service - Access to VLL Ethernet Pipe (Epipe) Service objects themselves.
epipe.PbbMacName	PBB MAC Name - Ability to configure the MAC Name Address for a Network Element.
epipe.Site	Epipe Site - Access to Epipe Sites.
equipment	Physical Equipment - General equipment configuration.
equipment.PortPolicy	Port Policy - Access to Port Policy for 7750 nodes.
equipment.Shelf.method_rebootUpgrade	Shelf - method_rebootUpgrade - Ability to perform node reboot upgrade.
ethernetequipment	Ethernet Equipment - Ethernet Equipment configuration.
ethernetoam	Ethernet OAM - Maintenance Domains and Maintenance Entity Groups, autogeneration of the MEPs on each SAP or Binding in a Service.

Table A-4 Permissions assigned to NFM-P scope of command roles (continued)

Package.Class.Method/Property	Description
ethernetoam.CcmTest	CFM Continuity Check - Access to Continuity Check tests, Continuity Check test definitions, and Continuity Check deployed tests.
ethernetoam.CcTest	Global Maintenance Entity Group - Access to Continuity Check tests, Continuity Check test definitions, and Continuity Check deployed tests.
ethernetoam.CfmDmmBin	CFM DMM Session Bin - Access to CFM DMM Test Session, CFM DMM Test Session definitions.
ethernetoam.CfmDmmSession	CFM DMM Test Session - Access to CFM DMM Test Session, CFM DMM Test Session definitions.
ethernetoam.CfmEthTest	CFM Eth Test - Access to CFM EthTests, CFM EthTest definitions, and CFM EthTest deployed tests.
ethernetoam.CfmLinkTrace	CFM Link Trace - Access to Link Trace tests, Link Trace test definitions, and Link Trace deployed tests.
ethernetoam.CfmLmmSession	CFM LMM Test Session - Access to CFM LMM Test Session, CFM LMM Test Session definitions.
ethernetoam.CfmLmTest	CFM LM Test - Access to CFM LM tests, CFM LM test definitions, and CFM LM deployed tests.
ethernetoam.CfmLoopback	CFM Loopback - Access to CFM Loopback tests, CFM Loopback test definitions, and CFM Loopback deployed tests.
ethernetoam.CfmOneWayDelayTest	CFM One Way Delay Test - Access to CFM One Way Delay tests, CFM One Way Delay test definitions, and CFM One Way Delay deployed tests.
ethernetoam.CfmOneWaySlm	CFM One Way SLM Test - Access to CFM One Way SLM tests, CFM One Way SLM test definitions, and CFM One Way SLM deployed tests.
ethernetoam.CfmSingleEndedLossTest	CFM Single Ended Loss Test - Access to CFM Single Ended Loss tests, CFM Single Ended Loss test definitions, and CFM Single Ended Loss deployed tests.
ethernetoam.CfmSlmSession	CFM SLM Test Session - Access to CFM SLM Test Session, CFM SLM Test Session definitions.
ethernetoam.CfmTwoWayDelayTest	CFM Two Way Delay Test - Access to CFM Two Way Delay tests, CFM Two Way Delay test definitions, and CFM Two Way Delay deployed tests.
ethernetoam.CfmTwoWaySlm	CFM Two Way SLM Test - Access to CFM Two Way SLM tests, CFM Two Way SLM test definitions, and CFM Two Way SLM deployed tests.
ethernetoam.EthSession	Ethernet Test Session - Access to Ethernet Test Session, Ethernet Test Session definitions.
ethernetoam.service	Ethernet Service Policy - SAP Profile and UNI Profile policies.
ethernetoam.tunnel	Ethernet Tunnel - Ethernet Tunnel configuration.
ethring	Ethernet Ring - Ethernet Ring Configuration.
event	events - Parent package for all event classes.

Table A-4 Permissions assigned to NFM-P scope of command roles (continued)

Package.Class.Method/Property	Description
fabricqos	Fabric QoS Policies - Fabric Profile QoS policy.
file	File Policy - File creation on the NE for events and accounting.
filter	Filter - Public search filters.
filterprefixlist	Filter Policy - Filter PrefixList and PortList Policies.
firewall	Firewall - All Firewall configurations.
fm	Fault Management - Alarm policies, Severity change thresholds, Alarms, Notes, and History.
fm.AlarmHistoryDatabase.method_purge	Alarm History Database - method_purge - Ability to purge the alarm history database.
fm.FaultManager	Fault Manager - Access to assign OLC state, alter severity, clear, acknowledge, and remove faults.
fm.FaultManager.method_editNote	Fault Manager - method_editNote - Ability to edit an alarm note.
fm.GlobalPolicy	Global Alarm Behavior - Access to configure the global alarm behavior.
fm.SpecificPolicy	Specific Alarm Policy - Access to configure specific alarm policies.
fpipe	FPipe - All contained objects are listed. Package access is not currently used.
fpipe.Fpipe	Fpipe Service - Access to Frame Relay Pipe (Fpipe) Service objects themselves.
fpipe.Site	Fpipe Site - Access to Fpipe Sites.
fr	Frame Relay - Frame Relay configuration for Service interfaces and routers.
generic	Generic - Generic configuration for NFM-P objects, deployment, and administrative state changes for DHCP and Multichassis objects, Maintenance Association End Points (MEP), and SRRP instances.
generic.GenericObject.method_collectData	Generic Object - method_collectData - Ability to collect and plot real-time statistics.
genericlog	Log Viewer - Display logs in Log Viewer.
genericne	Generic NE - Generic NE Interface and Profile configuration.
genericne.GenericNeProfileManager.method_checkFileContent	Generic NE Profiles - method_checkFileContent - Checks the descriptor installation package content for validity.
genericne.GenericNeProfileManager.method_installFile	Generic NE Profiles - method_installFile - Ability to install a descriptor driver.
gmpls	ASON Domain Management - GMPLS Management.
gmplsuni	GMPLS-UNI - GMPLS-UNI Configuration.
gsmp	GSMP - General Switch Management Protocol (GSMP) configuration for VPLS, MVPLS and VPRN routing instances.

Table A-4 Permissions assigned to NFM-P scope of command roles (continued)

Package.Class.Method/Property	Description
histcorr	Historical Correlation - Historical Correlation configuration.
hpipe	HPipe - All contained objects are listed. Package access is not currently used.
hpipe.Hpipe	Hpipe Service - Access to HPipe (Hpipe) Service objects themselves.
hpipe.Site	Hpipe Site - Access to Hpipe Sites.
icmp	ICMP - Internet Control Message Protocol (ICMP) and Domain Name System (DNS) test results.
icmp.DnsPing	DNS Ping - Access to DNS Ping tests, DNS Ping test definitions, and DNS Ping deployed tests.
icmp.IcmpPing	ICMP Ping - Access to ICMP Ping tests, ICMP Ping test definitions, and ICMP Ping deployed tests.
icmp.IcmpTrace	ICMP Trace - Access to ICMP Trace tests, ICMP Trace test definitions, and ICMP Trace deployed tests.
ies	IES - Access to this package is for configuring Group Interfaces, SAPs, MSAPs, IGMP Host Tracking on Sites and SAPs, and FR Interface Specifics for IES specific SAPs.
ies.AaInterface	IES AA Interface - Access to IES AA Interfaces.
ies.Ies	IES Service - Access to Internet Enhanced Service (IES) Service objects themselves.
ies.L3AccessInterface	IES L3 Access Interface - Access to IES L3 Access Interfaces.
ies.Site	IES Site - Access to IES Sites.
ies.SubscriberInterface	IES Subscriber Interface - Access to IES Subscriber Interfaces.
igh	IGH - Interface-Group-Handlers.
igmp	IGMP - Internet Group Management Protocol (IGMP) configuration for Service interfaces and routers.
igmp.Site	IGMP Site - Access to IGMP Sites.
impact.FullReset	Full Reset - Ability to configure objects which will result in a full reset of the node. Currently applies to 9412 node.
impact.PartialReset	Partial Reset - Ability to configure objects which will result in a partial reset of impacted SW/HW unit. Currently applies to 9412 node.
ipdr	IPDR File Transfer Policies - IPDR file transfer policies.
ipfix	IPFIX - IPFIX Policy.
ipipe	IPipe - Access to this package is for configuring IPCP on L2 Access Interfaces and FR Interface Specifics for Ipipe specific SAPs.
ipipe.Ipipe	Ipipe Service - Access to IP Interworking Pipe (Ipipe) Service objects themselves.
ipipe.L2AccessInterface	L2 Access Interface - Access to IPipe L2 Access Interfaces.

Table A-4 Permissions assigned to NFM-P scope of command roles (continued)

Package.Class.Method/Property	Description
ipipe.Site	Ipipe Site - Access to Ipipe Sites.
ipsec	IP Security - IKE Policy and IPsec Transform.
isa	ISA - ISA-IPsec, ISA-MG, and ISA-AA configuration on a MDA card for IP Security, and Application Assurance.
isa.IPSecMglsaGroup	ISA IPSMG Group - Configuration of IPsec ISA-MG Group.
isa.IPSecMglsaGroupMdaAssociation	ISA-IPSMG Group MDA Association - Configuration of ISA-IPSMG Group MDA Association.
isa.MgGroupMember	ISA-MG Group Member - Configuration of ISA-MG Group Member.
isa.MglsaGroup	ISA-MG Group - Configuration of ISA-MG Group.
isis	Routing Management: ISIS - IS-IS configuration for Service interfaces and routers, Area, Adjacency, Neighbors, Policies and other IS-IS related objects.
l2fib	L2 FIB - Layer 2 Forwarding Information Base (FIB) configuration for Multicast and Non-Multicast.
l2fwd	L2 Forwarding - All Layer 2 Forwarding configuration for Service interfaces and routers, circuits, ports, Spanning Tree, Registration, FIB, Mac Protection, IGMP Snooping, etc.
l2tp	L2TP - L2TP configuration for Service interfaces and routers, Groups, Tunnels, PeersRPs, and other L2TP related objects.
l3fwd	L3 Forwarding - All Layer 3 Forwarding configuration for Service interfaces and routers, Import and Export policies, Dot1p and DSCP for VPRNs.
lag	LAG - Link Aggregation Group (LAG) configuration for Service interfaces and routers.
layer2	Layer 2 - All Layer 2 configuration: Bridges, Transparent LAN Service (TLS), and VLAN interfaces.
ldp	Routing Management: LDP - Label Distribution Protocol (LDP) configuration for Service interfaces and routers, Session, MD5 Key, Equal-Cost Multipath Routing (EMCP), Forwarding Equivalency Class (FEC), Policies, and Peers.
lldp	LLDP - Link Layer Discovery Protocol (LLDP) configuration on equipment.PhysicalPort.
lmg	LMG - All LMG configurations and status.
lmgperf	LMG Performance Management - All LMG configurations.
lmp	LMP - LMP Configuration for Sites.
localuserdb	Local User DB - DHCP or PPPoE configuration for Local User Databases on a router.
log	Statistics - Parent package for all statistics classes.

Table A-4 Permissions assigned to NFM-P scope of command roles (continued)

Package.Class.Method/Property	Description
log.LogToFileManager.property_jmsRetries	Log To File Manager - property_jmsRetries - LogToFile preferences can only be modified by a user with an administrator role.
log.LogToFileManager.property_retention	Log To File Manager - property_retention - LogToFile preferences can only be modified by a user with an administrator role.
log.LogToFileManager.property_rollover	Log To File Manager - property_rollover - LogToFile preferences can only be modified by a user with an administrator role.
log.LogToFileManager.property_storeAccountingStatsInDB	Log To File Manager - property_storeAccountingStatsInDB - LogToFile preferences can only be modified by a user with an administrator role.
log.LogToFileManager.property_storePerformanceStatsInDB	Log To File Manager - property_storePerformanceStatsInDB - LogToFile preferences can only be modified by a user with an administrator role.
lps	LPS - Learned Port Security (LPS) configuration for layer2.Bridge and MAC Entries for ports.
mediation	Router Admin: Policies - Router administration: Backup Policies, Upgrade Policies and Software images, Deployment Policies, and Management Ping Policies.
mirror	Mirror - All configurations for Service Mirroring.
mirror.Endpoint	Endpoint - Access to MIRROR Endpoints.
mirror.Mirror	Mirror Service - Access to Mirror Service objects themselves.
mirror.Site	Mirror Site - Access to Mirror Sites.
mld	MLD - Multicast Listener Discovery Protocol (MLD) configuration for a Service interfaces and routers.
monitor	Monitor - Subscriber Host monitoring and SAP monitoring.
monpath	Monitored Path - IP path monitoring and LSP monitoring.
mpls	Path/Routing Management: MPLS - Multiprotocol Label Switching (MPLS) configuration on a rtr.VirtualRouter, LSPs, Segments, Hops, Tunnels, CrossConnects, and other MPLS related objects.
mpls.LdpTreeTrace	LDP Tree Trace - Access to LDP Tree Trace tests, LDP Tree Trace test definitions, and LDP Tree Trace deployed tests.
mpls.LspPing	LSP Ping - Access to LSP Ping tests, LSP Ping test definitions, and LSP Ping deployed tests.
mpls.LspTrace	LSP Trace - Access to LSP Trace tests, LSP Trace test definitions, and LSP Trace deployed tests.
mpls.P2MPLspPing	P2MP LSP Ping - Access to P2MP LSP Ping tests, P2MP LSP Ping test definitions, and P2MP LSP Ping deployed tests.
mpls.P2MPLspTrace	P2MP LSP Trace - Access to P2MP LSP Trace tests, P2MP LSP Trace test definitions, and P2MP LSP Trace deployed tests.
mplstp	MPLS TP - MPLS TP Configuration for Sites.
mpr	9500 MPR - 9500 Microwave Packet Radio (MPR) VLAN Paths and Hops.

Table A-4 Permissions assigned to NFM-P scope of command roles (continued)

Package.Class.Method/Property	Description
mpr.Cpipe	9500 MPR Cpipe Service - Access to VLL Circuit Emulation Pipe (Cpipe) Service objects themselves.
mpr.EI2AccessInterface	9500 MPR Epipe L2 Access Interface - Access to L2AccessInterface objects.
mpr.Epipe	9500 MPR Epipe Service - Access to VLL Ethernet Pipe Service objects themselves.
mpr.Esite	9500 MPR Epipe Site - Access to the service instance objects.
mpr.L2AccessInterface	9500 MPR Cpipe L2 Access Interface - Access to L2AccessInterface objects.
mpr.Site	9500 MPR Cpipe Site - Access to the service instance objects.
msappolicy	MSAP Policy - MSAP policy configuration.
msdp	MSDP - Multicast Source Discovery Protocol (MSDP) configuration for a rtr.VirtualRouter, MD5 Key, Peers, Policies and Source.
multicast	Multicast - Multicast Connection Admission Control (CAC) Policies and Bandwidth Policies.
multicast.CustomerVlanTag	Customer Vlan Tag - Configuration of Customer VLAN Tags for a Multicast VLAN.
multicast.MfibPing	MFIB Ping - Access to MFIB Ping tests, MFIB Ping test definitions, and MFIB Ping deployed tests.
multicast.Mrinfo	Mrinfo - Access to Mrinfo tests, Mrinfo test definitions, and Mrinfo deployed tests.
multicast.Mtrace	Mtrace - Access to Mtrace tests, Mtrace test definitions, and Mtrace deployed tests.
multicastmgr	CPAM: Multicast - All CPAM Multicast related objects: PIM Domain, VPLS Domain, Groups, and Sources.
multichassis	Multi-Chassis - Multi-Chassis configuration for a router; LAGs, Rings, Syncs, Peers, VLAN Ranges, IPsecs.
mvpls	MVPLS - All contained objects are listed. Package access is not currently used.
mvpls.BL2AccessInterface	MVPLS B-L2 Access Interface - Access to MVPLS B-L2 Access Interfaces.
mvpls.BSite	MVPLS B-Site - Access to MVPLS B-Sites.
mvpls.EvpnSite	MVPLS EVPN-Site - Access to MVPLS EVPN-Sites on a MVPLS Service.
mvpls.IL2AccessInterface	MVPLS I-L2 Access Interface - Access to MVPLS I-L2 Access Interfaces.
mvpls.ISite	MVPLS I-Site - Access to MVPLS I-Sites.
mvpls.L2AccessInterface	MVPLS L2 Access Interface - Access to MVPLS L2 Access Interfaces (except I and B).

Table A-4 Permissions assigned to NFM-P scope of command roles (continued)

Package.Class.Method/Property	Description
mvpls.Mvpls	MVPLS Service - Access to Management Virtual Private LAN Service (MVPLS) Service objects themselves.
mvpls.Site	MVPLS Site - Access to MVPLS Sites (except I and B).
mvrp	MVRP - MVRP global configuration and for Interfaces(Ports and LAG's).
mwa	Microwave Aware - Access to MW (Microwave) Link and MW Link Members configuration for Service interfaces and routers.
nat	Network Address Translation - NAT Policy.
nat.LsnSubSession	LSN Subscriber Session - Access to NAT Package.
nat.PcpServer	Port Control Protocol Server - Access to Port Control Protocol Server configuration.
nat.PcpServerInterface	Port Control Protocol Server Interface - Access to Port Control Protocol Interface configuration.
neaudit	NE Audit Management - Ability to manage NE Audits.
negcss	Network Element Golden Config Snapshot - Golden Config Webapp.
nelicense	NeLicense - Apply License on the node.
netca	NE Threshold Crossing Alerts - Manage NE Threshold Crossing Alert profiles.
netw	Network - Network objects: groups and links.
netw.AdvertisedNode	Advertised Node - Control of Discovered Nodes.
netw.NeLimitHolder	NE Limits - Access to NE Limit configuration.
netw.NetworkElement	Network Element - Access to Network Elements.
netw.NetworkElement.method_executeCli	Network Element - method_executeCli - Execute a single raw CLI command on this Network Element.
netw.NetworkElement.method_executeMultiCli	Network Element - method_executeMultiCli - Execute Multiple CLI commands on this Network Element.
netw.NetworkElement.method_GUICrossLaunch	Network Element - method_GUICrossLaunch - The ability to launch LTE web-browser based tools.
netw.NetworkElement.method_NetoAdminProfileBasedLaunch	Network Element - method_NetoAdminProfileBasedLaunch - The ability to launch Neto with Admin profile.
netw.NetworkElement.method_NetoViewerProfileBasedLaunch	Network Element - method_NetoViewerProfileBasedLaunch - The ability to launch Neto with Viewer profile.
netw.NetworkElement.property_elementManagerCmd	Network Element - property_elementManagerCmd - Ability to update the 'Alternate Element Manager' command for a GNE.
netw.NodeDiscoveryControl	Node Discovery Control - Control of Discovered Nodes.
netw.Topology	Discovery Manager - Access to the Discovery Manager.

Table A-4 Permissions assigned to NFM-P scope of command roles (continued)

Package.Class.Method/Property	Description
netw.Topology.method_move	Discovery Manager - method_move - Ability to move a node or group on the NFM-P Client GUI maps.
netw.UplinkBofConfiguration	Uplink Bof Configuration - Ability to configure the Uplink BOF for a 7210 node.
netw.UplinkRouteConfiguration	Uplink Route Configuration - Ability to configure the Uplink Routes for a 7210 node.
nge	NetworkGroupEncryption - Network Group Encryption configuration on 7705 router.
niegr	Network Ingress/Egress Policy - Network Policies.
nodelog	Node Log Policy - Filter Log and Sys Log Target Policies.
nqueue	Network Queue Policy - Network Queue QoS Policies.
ntp	Network Time Protocol - Network Time Protocol.
ntp.NTPBroadcast	NTP Broadcast - Ability to configure broadcast for ntp params.
ntp.NTPMulticast	NTP Multicast - Ability to configure multicast for ntp params.
olc	Object Life Cycle.
olc.OLCSchedulerManager.property_autosetMaintenanceOLCStateOnAdminDown	OLC Scheduler Manager - property_autosetMaintenanceOLCStateOnAdminDown - Service preferences can only be modified by a user with an administrator role.
olc.OLCSchedulerManager.property_createAlarmNotification	OLC Scheduler Manager - property_createAlarmNotification - OLC preferences can only be modified by a user with an administrator role.
olc.OLCSchedulerManager.property_leadTimeForNotification	OLC Scheduler Manager - property_leadTimeForNotification - OLC preferences can only be modified by a user with an administrator role.
openflow	OpenFlow - OpenFlow configuration and status on a router.
optical	Optical Management - Optical NE Specific Information.
optical.MultipointServicePath	Multipoint Service Path - Access for all Multi Point Service Paths.
optical.MultipointTransportService	Multipoint Transport Service - Access for all optical services.
optical.OCHTrail	OCH Trail - Access for all OCH trails.
optical.ODUTrail	ODU Trail - Access for all ODU trails.
optical.OMSTrail	OMS Trail - Access for all OMS trails.
optical.OTSTrail	OTS Trail - Access for all OTS trails.
optical.OTUTrail	OTU Trail - Access for all OTU trails.
optical.STMTrail	STM Trail - Access for all STM trails.
optical.TransportService	Optical Transport Service - Access for all optical services.
opticalacl	Optical Access Control Lists - ACL Management.
opticalequipment	Optical Management - Optical NE Specific Configuration.

Table A-4 Permissions assigned to NFM-P scope of command roles (continued)

Package.Class.Method/Property	Description
opticalrouting	Optical Routing - Optical Routing Meta.
opticsperf	Optics Specifics - All 1830 PSS configurations.
ospf	Routing Management: OSPF - OSPF configuration for Service interfaces and routers, Area, Adjacency, MD5 Key, Virtual Links Neighbors, LSAs, Policies and other OSPF related objects.
ospf.Site	OSPF Site - Access to OSPF Sites.
oss	XML API - Ability to connect to the NFM-P through the XML API interface.
oth	Optical Transport Hierarchy - OTH Management.
pae802_1x	PAE 802.1x - Port Access Entity (PAE) configuration for a router and physical port; RADIUS Server Policy.
pbbvlan	PBBVLAN - Access to this package is for configuring SPB-BVLAN Service, Site, SAPs, MeshSDPs and site statistics.
pbbvlan.Site	SPB Site - Access to SPB Services.
pbbvlan.VlanPBBEdge	SPB Service - Access to SPB Services.
pim	PIM - PIM configuration for Service interfaces and routers, MDT Threshold, Policies, Neighbors, Groups, RPs, Multicast CAC Level and LAG Port Down events, and other PIM related objects.
pim.Site	PIM Site - Access to PIM Sites.
policing	Policing Policy - Policer Control.
policy	Policy - Parent package for all policies; Policy Audits, Policy Export/Imports.
policy.PolicyDefinition.method_setConfigurationModeToReleased	Policy Definition - method_setConfigurationModeToReleased - Ability set Configuration Mode to Released and distribute the global policy to the local definitions network-wide.
policy.PolicyDefinition.method_setDistributionModeToLocalEditOnly	Policy Definition - method_setDistributionModeToLocalEditOnly - Ability set Configuration Mode to Local Edit Only for local policies and ignore changes to the global policy.
policy.PolicyDefinition.method_setDistributionModeToSyncWithGlobal	Policy Definition - method_setDistributionModeToSyncWithGlobal - Ability set Configuration Mode to Sync with Global and synchronize local policies with the most recent released global policy.
policy.PolicyNameManager.property_autoDistributeOnRelease	Policies - property_autoDistributeOnRelease - Policy preferences can only be modified by a user with an administrator role.
policy.PolicyNameManager.property_localEditOnly	Policies - property_localEditOnly - Policy preferences can only be modified by a user with an administrator role.
policy.PolicyNameManager.property_localEditOnlyOnCLIChange	Policies - property_localEditOnlyOnCLIChange - Policy preferences can only be modified by a user with an administrator role.
policy.PolicyNameManager.property_maxScheduledAuditResultPerLocalPolicy	Policies - property_maxScheduledAuditResultPerLocalPolicy - Policy preferences can only be modified by a user with an administrator role.

Table A-4 Permissions assigned to NFM-P scope of command roles (continued)

Package.Class.Method/Property	Description
policy.PolicyNameManager.property_securityZoneDiscoveredInLocalEditOnlyMode	Policies - property_securityZoneDiscoveredInLocalEditOnlyMode - Policy preferences can only be modified by a user with an administrator role.
policy.PolicyNameManager.property_showFilterDisplayName	Policies - property_showFilterDisplayName - Policy preferences can only be modified by a user with an administrator role.
policy.PolicyNameManager.property_showQoSPolicyDisplayName	Policies - property_showQoSPolicyDisplayName - Policy preferences can only be modified by a user with an administrator role.
policy.PolicySyncGroupManager	Policy Sync Group - Ability to configure and control policy sync group.
policy.ProfileManager	Profile Manager - Ability to configure and control profiles.
policytestutil	Policy Test Utility - TODO.
port.RestrictModeConfigModify	port.RestrictModeConfigModify - Ability to restrict Port Mode modification for Ports with dependencies.
portscheduler	Port Scheduler Policy - Port Scheduler and HSMDA Scheduler Policies.
ppp	PPP - Point-to-Point Protocol (PPP) configuration on a router.
pppoe	PPP Policy and Session - Point-to-Point Protocol over Ethernet over ATM (PPPoE/PPPoEoA/PPPoA) Policies and Sessions.
propertyrules	Property Rules - Range and Format Value Policies.
ptp	Precision Timing Protocol - Access to this package is for configuring Precision Timing Protocol.
pxc	PXC - Port Cross Connect.
qgroup	Queue Group Policy - Queue Group Policies.
qosprefixlist	QoS Policy - QoS PrefixList Policy.
qosprofile	Multilink QoS Profile - Multilink PPP QoS Profiles and Multilink Frame Relay QoS Profiles.
radioequipment	Radio Equipment - Radio Equipment configuration.
radiusaccounting	Radius Accounting - Radius Accounting Policy.
ranlicense	NE License Management - Ability to manage NE licenses.
ranradiom	eNodeB Router Admin: radio measurement - eNodeB Router administration: radio measurement.
rca	RCA - Root Cause Analysis (RCA) for verification functions (OSPF Area, IS-IS Area, BGP AS, ..).
rca.RcaManager.method_fixProblem	Rca Manager - method_fixProblem - Ability to fix a problem on an object.
rca.RcaManager.method_preFixProblem	Rca Manager - method_preFixProblem - Ability to determine if a problem can be fixed, and the fix impact.
redirectfilter	Redirect Filter Policy - Redirect Filters.
resiliency	HSDPA Resiliency - HSDPA Resiliency for services.

Table A-4 Permissions assigned to NFM-P scope of command roles (continued)

Package.Class.Method/Property	Description
resources	NFM-P Resources - NFM-P Resource Pools as configured in the nms-server.xml file.
ressubscr	Residential Subscriber - All Residential Subscriber configuration including Connectivity Verifications (SHCV), SAPs, Packages, Hosts, QoS, and other related objects.
ressubscr.BgpPeeringPolicy	BGP Peering Policy - Access to BGP Peering Policies.
ressubscr.HostTrackingPolicy	Host Tracking Policy - Access to Host Tracking Policies.
ressubscr.IgmpPolicy	IGMP Policy - Access to IGMP Policies.
ressubscr.IpoePolicy	IPoE Session Policy - Access to IPoE Session Policies.
ressubscr.MldPolicy	MLD Policy - Access to MLD Policies.
ressubscr.ResidentialSubscriberManager.property_hostTrkSubscrRtrvTimeOut	Residential Subscriber Manager - property_hostTrkSubscrRtrvTimeOut - Service preferences can only be modified by a user with an administrator role.
ressubscr.ResidentialSubscriberManager.property_qbtUeRtrvTimeOut	Residential Subscriber Manager - property_qbtUeRtrvTimeOut - Service preferences can only be modified by a user with an administrator role.
ressubscr.ResidentialSubscriberManager.property_resSubscrInstRtrvMax	Residential Subscriber Manager - property_resSubscrInstRtrvMax - Service preferences can only be modified by a user with an administrator role.
ressubscr.ResidentialSubscriberManager.property_retrieveAcclpEncap	Residential Subscriber Manager - property_retrieveAcclpEncap - Service preferences can only be modified by a user with an administrator role.
ressubscr.ResidentialSubscriberManager.property_retrieveBgpPeerInfo	Residential Subscriber Manager - property_retrieveBgpPeerInfo - Service preferences can only be modified by a user with an administrator role.
ressubscr.ResidentialSubscriberManager.property_retrieveBgpPeerV6Info	Residential Subscriber Manager - property_retrieveBgpPeerV6Info - Service preferences can only be modified by a user with an administrator role.
ressubscr.ResidentialSubscriberManager.property_retrieveManagedRoutes	Residential Subscriber Manager - property_retrieveManagedRoutes - Service preferences can only be modified by a user with an administrator role.
ressubscr.ResidentialSubscriberManager.property_retrieveQoSovr	Residential Subscriber Manager - property_retrieveQoSovr - Service preferences can only be modified by a user with an administrator role.
ressubscr.ResidentialSubscriberManager.property_retrieveSlaacHostAddr	Residential Subscriber Manager - property_retrieveSlaacHostAddr - Service preferences can only be modified by a user with an administrator role.
ressubscr.ResidentialSubscriberManager.property_subscriberHostRtrvTimeOut	Residential Subscriber Manager - property_subscriberHostRtrvTimeOut - Service preferences can only be modified by a user with an administrator role.
ressubscr.ShcvPolicy	SHCV Policy - Access to SHCV Policies.
ressubscr.SubMcastCacPolicy	Subscriber Multicast CAC Policy - Access to Subscriber Multicast CAC Policies.

Table A-4 Permissions assigned to NFM-P scope of command roles (continued)

Package.Class.Method/Property	Description
rip	Routing Management: RIP - Routing Information Protocol (RIP) configuration for Service interfaces and routers, Authentication Key, Groups, Export and Import Policies.
rip.Site	RIP Site - Access to RIP Sites.
rmd	Remote Managed Device - Remote Managed Device Management.
rmon	Remote Network Monitoring - Remote Network Monitoring Alarm and Event Policies.
rollback	Rollback - All scheduled tasks; Cron Actions, XML API Commands, CLI Scripts and Schedules.
rp	Routing Policy - Policy Statements, Prefix Lists, Communities, Damping, and AS Paths.
rsvp	Routing Management: RSVP - RSVP configuration for a rtr.VirtualRouter, Authentication Keys, and Neighbors.
rtr	Routing Management: General - General rtr.VirtualRouter configurations including Neighbor Discovery, DHCP Relays, Interfaces, Peers, Address Ranges and ARP, Routes and Router Advertisement.
rules	Rules - Rule Repository and Sets of rules that may get invoked when a rule engine is fired.
sas	Assurance - Parent package for all tests; Service Test Manager.
sas.IPSession	IP Session - Access to IP Session, IP Test Session definitions.
sas.TestManager.property_contextNonSapMax	Service Test Manager - property_contextNonSapMax - OAM Context preferences can only be modified by a user with an administrator role.
sas.TestManager.property_contextSapMax	Service Test Manager - property_contextSapMax - OAM Context preferences can only be modified by a user with an administrator role.
sas.TestManager.property_defaultTestResultStorage	Service Test Manager - property_defaultTestResultStorage - These preferences can only be modified by a user with an administrator role.
sas.TestManager.property_sasNumberOfHours	Service Test Manager - property_sasNumberOfHours - These preferences can only be modified by a user with an administrator role.
sas.TestManager.property_sasRetention	Service Test Manager - property_sasRetention - LogToFile preferences can only be modified by a user with an administrator role.
sas.TestManager.property_sasRollover	Service Test Manager - property_sasRollover - LogToFile preferences can only be modified by a user with an administrator role.
sas.TWLBIn	TWAMP Light Session Bin - Access to TWAMP Light Test Session, TWAMP Light Test Session definitions.
sas.TwIReflector	TWAMP Light Reflector - Access to TWAMP Light Reflector.
sas.TWLSession	TWAMP Light Test Session - Access to TWAMP Light Test Session, TWAMP Light Test Session definitions.
sas.VxlanPing	VXLAN Ping - Access to VXLAN Ping tests, VXLAN Ping test definitions, and VXLAN Ping deployed tests.

Table A-4 Permissions assigned to NFM-P scope of command roles (continued)

Package.Class.Method/Property	Description
saspm	SAS PM - Access to OAM Performance Monitoring Objects.
sasqos	7210 and 1830 QoS - QoS Policies for 7210 and 1830 nodes.
sasqos.QosPool	QoS Pool - Access to QoS Pools for 7210 nodes.
schedule	Schedule - All scheduled tasks; Cron Actions, XML API Commands, CLI Scripts and Schedules.
script	Scripting - Script Management and execution of Service and Tunnel Template, XML API, and CLI scripts.
script.AbstractScript.method_configureTarget	Script - method_configureTarget - Ability to configure targets and instances.
script.AbstractScript.method_configureTargets	Script - method_configureTargets - Ability to configure targets and instances.
script.Bundle	Script Bundle - Ability to configure script bundles.
script.ControlScript	Control Script - Ability to configure control scripts.
script.ControlScriptVersion	Control Script Version - Ability to configure Control script versions.
script.HandlerBinding	Handler Script Binding - Ability to configure associations between scripts and control scripts.
script.InvokerBinding	Invoker Script Binding - Ability to configure associations between scripts and control scripts.
script.JsonTargetParameter	JSON Target Parameter - Ability to configure target/instance JSON parameters.
script.LargeTextTargetParameter	Large Text Target Parameter - Ability to configure target/instance large text parameters.
script.Result	Result - Ability to create script results.
script.Script	CLI Script - Ability to configure CLI scripts.
script.Script.method_createTargetScript	CLI Script - method_createTargetScript - Ability to configure targets.
script.Script.method_createTargetScripts	CLI Script - method_createTargetScripts - Ability to configure targets.
script.ScriptManager	Script Manager - Ability to configure and control scripts and script operations.
script.ScriptManager.method_configure	Script Manager - method_configure - Ability to configure scripts.
script.ScriptManager.method_copyContents	Script Manager - method_copyContents - Ability to copy scripts.
script.ScriptManager.method_exportBundle	Script Manager - method_exportBundle - Ability to export bundle.
script.ScriptManager.method_importBundle	Script Manager - method_importBundle - Ability to import bundle.
script.ScriptManager.method_importBundleSimulation	Script Manager - method_importBundleSimulation - Ability to import bundle.
script.ScriptScheduledTask	Script Scheduled Task - Ability to schedule a script.
script.TargetParameter	Target Parameter - Ability to configure target/instance parameters.

Table A-4 Permissions assigned to NFM-P scope of command roles (continued)

Package.Class.Method/Property	Description
script.TargetParameterItem	Target Parameter Item - Ability to configure target/instance parameter items.
script.TargetParameterList	Target Parameter List - Ability to configure target/instance parameter lists.
script.TargetScript	Target Script - Ability to configure targets and instances.
script.TemplateBinding	Template Binding - Ability to configure associations between templates.
script.Version	Version - Ability to configure CLI script versions.
script.XmlApiConfigTemplate	Template - Ability to configure XML API templates.
script.XmlApiConfigTemplate.method_execute	Template - method_execute - Ability to create an object from a template.
script.XmlApiConfigTemplate.method_executeMulti	Template - method_executeMulti - Ability to create an object from a template.
script.XmlApiConfigTemplate.method_executeScript	Template - method_executeScript - Ability to create an object from a template.
script.XmlApiConfigTemplate.method_serviceTemplateExecute	Template - method_serviceTemplateExecute - Ability to execute a service template.
script.XmlApiConfigTemplate.method_tunnelTemplateExecute	Template - method_tunnelTemplateExecute - Ability to execute a tunnel template.
script.XmlApiScript	XMLAPI Script - Ability to configure XML API scripts.
script.XmlApiVersion	XMLAPI Version - Ability to configure XML API script versions.
security	Security - NFM-P User security including Sessions, TCP KeyChains, and SSH2 Known Host Keys.
security.MediationPolicy	Mediation Policy - Access to Mediation Policies. Used in conjunction with snmp.PollerManager.
security.MessagingConnection	Messaging Connection - Ability to view messaging connections.
security.RoleBasedAccess	security.RoleBasedAccess - Ability to restrict online object creation and deletion to a specific role. Currently applies to 9412 node.
security.ScopeOfCommandProfile	Profile - Access to Scope of Command Profile configuration.
security.ScopeOfCommandRole	Role - Access to Scope of Command Role configuration.
security.Span	Span - Access to Span configuration. Used in conjunction with security.SpanObjectBinding.
security.SpanObjectBinding	Span Objects - Access to Span object configuration. Used in conjunction with security.Span.
security.SpanOfControlProfile	Profile - Access to Span of Control Profile configuration.
security.User	User - Access to User object configuration and password changes.
security.UserGroup	User Group - Access to UserGroup configuration.

Table A-4 Permissions assigned to NFM-P scope of command roles (continued)

Package.Class.Method/Property	Description
securitypolicy	Security Policy - All Security configurations including security policy,profile,zone,NAT.
securityqueue	Security Queue QoS Policies - Security Queue QoS policy.
selfconfig	Self Config - Ability to configure self config objects.
server	NFM-P Server - NFM-P Servers (JMS, Main, Auxiliary Server, Auxiliary Database) as configured in the nms-server.xml file.
service	Service Management - Parent package for all services; Composite Services and Connectors and Access Policy Queue Override Policies.
service.AarpInterface	AARP Interface - Access to AARP Interface configuration between AARP.
service.CpePing	CPE Ping - Access to CPE Ping tests, CPE Ping test definitions, and CPE Ping deployed tests.
service.GneAccessInterface	GNE Service Interface - Access to GNE Service Interfaces.
service.GneSite	GNE Site - Access to GNE Sites.
service.MacPing	MAC Ping - Access to MAC Ping tests, MAC Ping test definitions, and MAC Ping deployed tests.
service.MacPopulate	MAC Populate - Access to MAC Populate tests, MAC Populate test definitions, and MAC Populate deployed tests.
service.MacPurge	MAC Purge - Access to MAC Purge tests, MAC Purge test definitions, and MAC Purge deployed tests.
service.MacTrace	MAC Trace - Access to MAC Trace tests, MAC Trace test definitions, and MAC Trace deployed tests.
service.RedundantInterface	Redundant Interface - Access to Redundant Interface configuration between SRRP instances.
service.Service.method_create	Service - method_create - Ability to create a service via the NFM-P Client GUI.
service.Service.method_highPriorityServiceDelete	Service - method_highPriorityServiceDelete - Ability to delete high priority Service.
service.Service.property_svcPriority	Service - property_svcPriority - Service priority can only be modified by a user with an administrator role.
service.ServiceManager.property_alarmAggregationCompositeService	Service Manager - property_alarmAggregationCompositeService - Service preferences can only be modified by a user with an administrator role.
service.ServiceManager.property_alarmAggregationSdp	Service Manager - property_alarmAggregationSdp - Service preferences can only be modified by a user with an administrator role.
service.ServiceManager.property_autoDiscoverCompositeSvc	Service Manager - property_autoDiscoverCompositeSvc - Service preferences can only be modified by a user with an administrator role.
service.ServiceManager.property_enableCac	Service Manager - property_enableCac - Service preferences can only be modified by a user with an administrator role.

Table A-4 Permissions assigned to NFM-P scope of command roles (continued)

Package.Class.Method/Property	Description
service.ServiceManager.property_enableRTConnection	Service Manager - property_enableRTConnection - Service preferences can only be modified by a user with an administrator role.
service.ServiceManager.property_generateReservedRrcAlarm	Service Manager - property_generateReservedRrcAlarm - Service preferences can only be modified by a user with an administrator role.
service.ServiceManager.property_maxNumberOfMoveSites	Service Manager - property_maxNumberOfMoveSites - Service preferences can only be modified by a user with an administrator role.
service.ServiceManager.property_multiSegmentTunnelSelection	Service Manager - property_multiSegmentTunnelSelection - Service preferences can only be modified by a user with an administrator role.
service.ServiceManager.property_propagateServiceNameToSites	Service Manager - property_propagateServiceNameToSites - Service preferences can only be modified by a user with an administrator role.
service.ServiceManager.property_propagateSiteNameToService	Service Manager - property_propagateSiteNameToService - Service preferences can only be modified by a user with an administrator role.
service.ServiceManager.property_propagateSvcNameDesc	Service Manager - property_propagateSvcNameDesc - Service preferences can only be modified by a user with an administrator role.
service.ServiceManager.property_removeEmptyService	Service Manager - property_removeEmptyService - Service preferences can only be modified by a user with an administrator role.
service.ServiceManager.property_safeSvcDelete	Service Manager - property_safeSvcDelete - Service preferences can only be modified by a user with an administrator role.
service.ServiceManager.property_supVprnSnmpCommunityStringMsg	Service Manager - property_supVprnSnmpCommunityStringMsg - Service preferences can only be modified by a user with an administrator role.
service.ServiceManager.property_svcPriority	Service Manager - property_svcPriority - Service priority can only be modified by a user with an administrator role.
service.ServiceMemberAuditPolicyEntry	Service Membership Audit Policy Entry - Access to Service Member Audit Policy Entry to configure service membership RCA audit behavior.
service.SitePing	Service Site Ping - Access to Service Site Ping tests, Service Site Ping test definitions, and Service Site Ping deployed tests.
service.TemplateService.method_constructServiceTemplate	Service Template - method_constructServiceTemplate - Ability to construct a Template from a Service.
service.TemplateService.method_constructTemplatedService	Service Template - method_constructTemplatedService - Ability to construct a Service from a Template.
service.Y1564TestHeadBiDirectional	Y1564 Bi-Directional Test - Access to Y1564 Bi-Directional tests, Y1564 Bi-Directional test definitions, and Y1564 Bi-Directional deployed tests.
sflow	sFlow - SFLOW Objects.
shaperqos	Shaper QoS Policies - Shaper QoS policy.
shg	Split Horizon Group - Split Horizon Groups for VPLS services.
simulator	CPAM: Simulator - Parent package for all CPAM simulated objects; Scenarios, Sessions, Change and Action events.
simulator.SimSession	Session - Access to simulation sessions for CPAM Impact Analysis.

Table A-4 Permissions assigned to NFM-P scope of command roles (continued)

Package.Class.Method/Property	Description
sitesecc	NE Security - All Network Element security configuration including NE System Security, RADIUS, TACACS+ and AOS Authentication, Site Management Access and CPM Filters, DoS Protection, Password Policy, Users and Profiles.
sitesecc.LocalUser	NE User - Access to NE Site User configuration.
sitesecc.UserProfile	Site User Profile - Access to NE Site User Profile configuration.
sitesecc.UserPublicKey	RSA Key - Public keys(SShv2) configuration for the system users.
slaprofile	SLA Profile - SLA Profiles for QoS Policies.
slope	Slope Policy - WRED Slope, HSMDA WRED Slope, HSMDA Pool, and Named Buffer Pool Policies.
slope.QosPool	QoS Pool - Access to QoS Pools for 7450 and 7750 nodes.
snmp	SNMP - SNMP Poller Policies, Event Notification Policies, Statistics Poller Policies.
snmp.EventNotificationPolicy	Event Notification Policy - Access to Event Notification Policies.
snmp.PollerManager	Mediation - Access to Mediation Policies. Used in conjunction with security.MediationPolicy.
snmp.PollerManager.method_resync	Mediation - method_resync - Ability to resync a Network Element. Requires 'update' access on netw.NetworkElement.
sonet	SONET Sync - SONET Synchronization for Shelf and Processor Cards.
sonetequipment	SONET Equipment - SONET Equipment configuration.
spanrules	Span Rules - Span Rules for service creation.
spb	SPB - Access to this package is for configuring SPB site and site statistics.
spb.AccessInterface	Access Interface - Access to SPB Interface of VPLS B-L2 Access Interfaces on a BVPLS Service.
spb.NetworkInterface	Network Interface - Access to SPB Network Interfaces.
spb.SpokeSdpBindingInterface	Spoke SDP Binding Interface - Access to SPB Interface of VPLS Spoke-SDP on a BVPLS Service.
squeue	Shared Queue Policy - Shared Queue Policies.
srmrmtauth	NFM-P Remote Authentication - Remote Authentication for NFM-P configuration of RADIUS, TACACS+, and LDAP authentication servers.
srpythongmt	Python Management - Python Management.
srrp	SRRP - Subscriber Routed Redundancy Protocol (SRRP) configuration for IES and VPRN services.
statistics	NFM-P Performance Statistics - NFM-P Performance Statistics (Memory, Alarm Rate, Snmp Traps, and Node Resyncs).
statsplot	Statistics Plotter - Statistics Plotter.

Table A-4 Permissions assigned to NFM-P scope of command roles (continued)

Package.Class.Method/Property	Description
subscr	Subscriber Management - Customers configuration.
subscr.Site	Subscriber Site - Access to Subscriber Sites.
subscrauth	Subscriber Authentication - Subscriber Authentication Policy using RADIUS for DHCP sessions.
subscrxpmap	Subscriber Explicit Map - Subscriber Explicit Map Entry.
subscrident	Subscriber Identification - Subscriber Identification Policy.
subscrprofile	Subscriber Profile - Subscriber Profile, SLA Entries, Access Policy Queue Overrides and Scheduler Policy Entry Overrides.
sup	Supervision - NFM-P Supervision (Dashboard).
svq	Aggregation Scheduler - Service and Subscriber Aggregation Scheduler, Ingress and Egress Aggregation Scheduler Overrides.
svr	Service Routing - All contained objects are listed. Package access is not currently used.
svt	Service Tunnel Management - All Service Tunnel configurations including Clouds, Service Distribution Path (SDP) Bindings and Pseudo Wires.
svt.BvlanTunnel	SPB BVLAN Tunnel (SDP) - Access to vlan Tunnel (SDP) configuration.
svt.L2TPv3Tunnel	L2TPv3 Tunnel (SDP) - Access to l2tpv3 Tunnel (SDP) configuration.
svt.MeshSdpBinding	Mesh SDP Binding - Access to Mesh SDP Binding configuration.
svt.MirrorSdpBinding	Mirror SDP Binding - Access to Mirror SDP Binding configuration.
svt.MtuPing	MTU Ping - Access to MTU Ping tests, MTU Ping test definitions, and MTU Ping deployed tests.
svt.SpokeSdpBinding	Spoke SDP Binding - Access to Spoke SDP Binding configuration.
svt.Tunnel	Tunnel - Access to Tunnel (or SDP object) configuration.
svt.TunnelPing	Tunnel Ping - Access to Tunnel Ping tests, Tunnel Ping test definitions, and Tunnel Ping deployed tests.
svt.VccvPing	VCCV Ping - Access to VCCV Ping tests, VCCV Ping test definitions, and VCCV Ping deployed tests.
svt.VccvTrace	VCCV Trace - Access to VCCV Trace tests, VCCV Trace test definitions, and VCCV Trace deployed tests.
svt.VlanPBBEdgeMeshSdpBinding	PBB VLAN Mesh SDP Binding - Access to PBB VLAN Mesh SDP Binding configuration.
sw	Router Admin: Software - Router administration: Backup Files, Card Software, Upgrade schedules, and Accounting Statistics Retrieval.
sw.BackupRestoreManager.method_backup	Backup/Restore Status - method_backup - Ability to perform a Network Element backup.
sw.BackupRestoreManager.method_restore	Backup/Restore Status - method_restore - Ability to perform a Network Element restore.

Table A-4 Permissions assigned to NFM-P scope of command roles (continued)

Package.Class.Method/Property	Description
swran	eNodeB Router Admin: Software - eNodeB Router administration: Upgrade schedules.
sysact	User Activity - User Activity.
taskmgmt	Task Management - Monitor the tasks being executed in the server.
tca	TCA Policy - Parent package for all TCA classes.
tca.TCAManager.property_maxTCAAlarmLimit	TCAManager - property_maxTCAAlarmLimit - TCA preferences can only be modified by a user with an administrator role.
tca.TCAManager.property_maxTCAAlarmResetInterval	TCAManager - property_maxTCAAlarmResetInterval - TCA preferences can only be modified by a user with an administrator role.
tdm	Optical Transport Hierarchy - TDM Management.
tdmequipment	TDM Equipment - TDM Equipment configuration.
template	Service Template - Deprecated 6.0: use XML API based configuration templates (see class script.XmlApiConfigTemplate).
tod	TOD - Time Of Day Range Policy.
todsuite	TOD Suite - Time Of Day Suite Policy for Egress and Ingress Entries.
topology	CPAM: Topology - All CPAM topology configurations including BGP, IS-IS, OSPF, CPAA, Links, Routers, Areas, Subnets, Checkpoints, and Route Alarms.
topologysim	CPAM: Simulated Topology - CPAM simulated IGP topology including Links, Routers, Areas, Subnets, and IP Paths.
trapmapper	Trap to Alarm Mapper - Trap to Alarm Mapper.
tunnelmgmt	Tunnel Management - All Tunnel related objects including Hubs, Spokes, Meshes, Chains, Rings, Two Neighbor, Class Forwarding and Rule-based Groups.
udprelay	UDP Relay - UDP Relay configuration and services for layer2.Bridge, DHCP Snooping for VLANs and Ports.
udptunnel	UDP Tunnel - Access to UDP Tunnel.
user	User Preference - NFM-P Client GUI preferences for Info Tables.
vlan	VLAN - Access to this package is for configuring TLS, MVR, Super VLAN, Customer VLAN, SAP and MSAP, Network Interfaces (Uplink Ports) and VLAN configuration for a MST Instance.
vlan.EthernetService	VLAN Ethernet Service - Access to VLAN Ethernet Services.
vlan.L2AccessInterface	VLAN Access Interface - Access to VLAN Access Interfaces.
vlan.Site	VLAN Site - Access to VLAN Sites.
vlan.Vlan	VLAN Service - Access to Virtual LAN (VLAN) Service objects themselves.

Table A-4 Permissions assigned to NFM-P scope of command roles (continued)

Package.Class.Method/Property	Description
vll	VLL - All contained objects are listed. Package access is not currently used.
vll.Endpoint	Endpoint - Access to VLL Endpoints.
vll.L2AccessInterface	L2 Access Interface - Access to VLL L2 Access Interfaces (except lpipe).
vpls	VPLS - Access to this package is for configuring MLD Snooping, PIM Snooping, DHCP Relay, Multicast CAC Level and LAG Port Down events, and discovered VLAN Elements.
vpls.BL2AccessInterface	VPLS B-L2 Access Interface - Access to VPLS B-L2 Access Interfaces on a VPLS Service.
vpls.BSite	VPLS B-Site - Access to VPLS B-Sites on a VPLS Service.
vpls.Endpoint	VPLS Endpoint - Access to VPLS Endpoints on a VPLS Service.
vpls.EvpnSite	VPLS eVPN-Site - Access to VPLS eVPN-Sites on a VPLS Service.
vpls.IL2AccessInterface	VPLS I-L2 Access Interface - Access to VPLS I-L2 Access Interfaces on a VPLS Service.
vpls.ISite	VPLS I-Site - Access to VPLS I-Sites on a VPLS Service.
vpls.L2AccessInterface	VPLS L2 Access Interface - Access to VPLS L2 Access Interfaces (except I and B) on a VPLS Service.
vpls.L2ManagementInterface	VPLS L2 Management Interface - Access to VPLS L2 Management Interfaces on a VPLS Service.
vpls.Site	VPLS Site - Access to VPLS Sites (except I and B) on a VPLS Service.
vpls.Vpls	VPLS Service - Access to Virtual Private LAN Service (VPLS) Service objects themselves.
vprn	VPRN - Access to this package is for configuring VPRN Router Instance Sites, SNMP Community, IPsec Interfaces, Group Interfaces, SAPs, MSAPs, IGMP Host Tracking on Sites and SAPs, and FR Interface Specifics for VPRN specific SAPs.
vprn.AaInterface	VPRN AA Interface - Access to VPRN AA Interfaces.
vprn.DVRSSite	VPRN dVRS Site - Access to dVRS VPRN Sites on a VPRN service.
vprn.IPMirrorInterface	IP Mirror Interface - Access to VPRN IP Mirror Interfaces.
vprn.L3AccessInterface	VPRN L3 Access Interface - Access to VPRN L3 Access Interfaces.
vprn.Site	VPRN Site - Access to VPRN Sites.
vprn.SubscriberInterface	VPRN Subscriber Interface - Access to VPRN Subscriber Interfaces.
vprn.Vprn	VPRN Service - Access to Virtual Private Routed Network (VPRN) Service objects themselves.
vprn.VprnPing	VPRN Ping - Access to VPRN Ping tests, VPRN Ping test definitions, and VPRN Ping deployed tests.

Table A-4 Permissions assigned to NFM-P scope of command roles (continued)

Package.Class.Method/Property	Description
vprn.VprnTrace	VPRN Trace - Access to VPRN Trace tests, VPRN Trace test definitions, and VPRN Trace deployed tests.
vrrp	VRRP - Virtual Router Redundancy Protocol (VRRP) configuration on rtr.NetworkInterface, IES and VPRN access interfaces, Authentication Keys, Priority Control Policies and Events.
vs	Scheduler Policy - Scheduler Policies.
webclient	WebClient - Access to the WebClient.
wlangw	WLAN Gateway - WiFi Offload.
workspace	Workspace - Ability to view workspaces, and Create/Edit/Delete private workspaces.
workspace.WorkspaceManager.method_publicControl	Workspace Manager - method_publicControl - Ability to create/edit/delete public workspaces.
wpp	WPP - Web Portal Protocol.
wpp.Site	WPP Site - Access to WPP Sites.

A.3 What is the permissions access for NFM-P scope of command roles?

A.3.1 Overview

Each predefined scope of command role has defined access levels to the available permissions based on what the role is designed to do. Permissions grant the following levels of access to an object package, class, method or property:

- Read-only—provides read access to an object class without the ability to create or delete objects.
- Read/write—provides full access to an object class that includes read, create, update/execute, and delete access.
- Read/update/execute—provides read and update/execute access to an object package or property, but does not provide delete access.
- Update/execute—provides update/execute access on class methods, and is typically combined with read access on the parent object package.
- No access.

To view the permission configuration of a scope of command role (default or custom), open the properties form of the role by performing the following steps:

1. Choose Administration→Security→NFM-P User Security from the main menu. The NFM-P User Security manager opens.
2. Click on the Scope of Command tab.
3. Select Role (Security) from the drop-down menu and click Search.

-
4. Select the required role and click Properties. The Role (Edit) form opens.
 5. Click on the Permissions tab.

The Permissions tab lists all permissions and the current access level configured on the scope of command role.

