



7450 Ethernet Service Switch
7750 Service Router
7950 Extensible Routing System
Virtualized Service Router
Release 23.10.R2

System Management Guide

3HE 19239 AAAD TQZZA 01
Edition: 01
December 2023

Nokia is committed to diversity and inclusion. We are continuously reviewing our customer documentation and consulting with standards bodies to ensure that terminology is inclusive and aligned with the industry. Our future customer documentation will be updated accordingly.

This document includes Nokia proprietary and confidential information, which may not be distributed or disclosed to any third parties without the prior written consent of Nokia.

This document is intended for use by Nokia's customers ("You"/"Your") in connection with a product purchased or licensed from any company within Nokia Group of Companies. Use this document as agreed. You agree to notify Nokia of any errors you may find in this document; however, should you elect to use this document for any purpose(s) for which it is not intended, You understand and warrant that any determinations You may make or actions You may take will be based upon Your independent judgment and analysis of the content of this document.

Nokia reserves the right to make changes to this document without notice. At all times, the controlling version is the one available on Nokia's site.

No part of this document may be modified.

NO WARRANTY OF ANY KIND, EITHER EXPRESS OR IMPLIED, INCLUDING BUT NOT LIMITED TO ANY WARRANTY OF AVAILABILITY, ACCURACY, RELIABILITY, TITLE, NON-INFRINGEMENT, MERCHANTABILITY OR FITNESS FOR A PARTICULAR PURPOSE, IS MADE IN RELATION TO THE CONTENT OF THIS DOCUMENT. IN NO EVENT WILL NOKIA BE LIABLE FOR ANY DAMAGES, INCLUDING BUT NOT LIMITED TO SPECIAL, DIRECT, INDIRECT, INCIDENTAL OR CONSEQUENTIAL OR ANY LOSSES, SUCH AS BUT NOT LIMITED TO LOSS OF PROFIT, REVENUE, BUSINESS INTERRUPTION, BUSINESS OPPORTUNITY OR DATA THAT MAY ARISE FROM THE USE OF THIS DOCUMENT OR THE INFORMATION IN IT, EVEN IN THE CASE OF ERRORS IN OR OMISSIONS FROM THIS DOCUMENT OR ITS CONTENT.

Copyright and trademark: Nokia is a registered trademark of Nokia Corporation. Other product names mentioned in this document may be trademarks of their respective owners.

© 2023 Nokia.

Table of contents

| | | |
|----------|--|-----------|
| 1 | Getting started..... | 18 |
| 1.1 | About this guide..... | 18 |
| 1.2 | System configuration process..... | 18 |
| 1.3 | Node management using VPRN..... | 19 |
| 1.4 | Conventions..... | 20 |
| 1.4.1 | Precautionary and information messages..... | 20 |
| 1.4.2 | Options or substeps in procedures and sequential workflows..... | 20 |
| 2 | Security..... | 22 |
| 2.1 | Authentication, authorization, and accounting..... | 22 |
| 2.1.1 | Authentication..... | 23 |
| 2.1.1.1 | Local authentication..... | 24 |
| 2.1.1.2 | RADIUS authentication..... | 24 |
| 2.1.1.3 | TACACS+ authentication..... | 27 |
| 2.1.1.4 | LDAP authentication..... | 28 |
| 2.1.1.5 | Password hashing..... | 34 |
| 2.1.2 | Authorization..... | 35 |
| 2.1.2.1 | Local authorization..... | 35 |
| 2.1.2.2 | RADIUS authorization..... | 35 |
| 2.1.2.3 | TACACS+ authorization..... | 36 |
| 2.1.2.4 | Authorization profiles for classic and model-driven management interfaces..... | 40 |
| 2.1.2.5 | Authorization support..... | 40 |
| 2.1.3 | Accounting..... | 42 |
| 2.1.3.1 | RADIUS accounting..... | 42 |
| 2.1.3.2 | TACACS+ accounting..... | 42 |
| 2.1.3.3 | Command accounting log events..... | 42 |
| 2.1.4 | Security controls..... | 43 |
| 2.1.4.1 | When a server does not respond..... | 43 |
| 2.1.4.2 | Authentication and authorization request flow..... | 44 |
| 2.2 | RADIUS VSAs..... | 45 |
| 2.2.1 | RADIUS configuration for file access control using VSAs..... | 47 |
| 2.3 | TACACS+ services and VSAs..... | 48 |
| 2.3.1 | TACACS+ configuration for file access control using VSAs..... | 49 |

| | | |
|---------|---|----|
| 2.4 | Control and management traffic protection..... | 52 |
| 2.4.1 | CPM filters..... | 52 |
| 2.4.1.1 | CPM filter packet match..... | 52 |
| 2.4.1.2 | CPM IPv4 and IPv6 filter entry match criteria..... | 53 |
| 2.4.1.3 | CPM MAC filter entry match criteria..... | 55 |
| 2.4.1.4 | CPM filter policy action..... | 56 |
| 2.4.1.5 | CPM filter policy statistics and logging..... | 56 |
| 2.4.1.6 | CPM filter: protocols and ports..... | 56 |
| 2.4.2 | CPM per-peer queuing..... | 61 |
| 2.4.3 | CPM queues..... | 61 |
| 2.4.4 | Centralized CPU protection..... | 61 |
| 2.4.4.1 | Protocol protection..... | 63 |
| 2.4.4.2 | CPU protection extensions for ETH-CFM..... | 64 |
| 2.4.4.3 | ETH-CFM ingress squelching..... | 66 |
| 2.4.5 | Distributed CPU protection..... | 68 |
| 2.4.5.1 | Policer..... | 69 |
| 2.4.5.2 | Applicability..... | 73 |
| 2.4.5.3 | Log events, statistics, status, and SNMP support..... | 73 |
| 2.4.5.4 | DCP policer resource management..... | 74 |
| 2.4.5.5 | Operational guidelines and tips..... | 74 |
| 2.4.6 | Classification-based priority for extracted protocol traffic..... | 75 |
| 2.4.7 | TTL security..... | 76 |
| 2.4.8 | Management Access Filter..... | 77 |
| 2.4.8.1 | MAF filter packet match..... | 77 |
| 2.4.8.2 | MAF IPv4/IPv6 filter entry match criteria..... | 77 |
| 2.4.8.3 | MAF MAC filter entry match criteria..... | 78 |
| 2.4.8.4 | MAF filter policy action..... | 79 |
| 2.4.8.5 | MAF filter policy statistics and logging..... | 79 |
| 2.5 | Other security features..... | 79 |
| 2.5.1 | SSH..... | 79 |
| 2.5.1.1 | SSH PKI authentication..... | 80 |
| 2.5.1.2 | Multichannel SSH..... | 82 |
| 2.5.1.3 | MAC client and server list..... | 83 |
| 2.5.1.4 | KEX client and server list..... | 83 |
| 2.5.1.5 | Regenerate the SSH key without disabling SSH..... | 84 |
| 2.5.1.6 | Cipher client and server list..... | 85 |

| | | |
|----------|--|-----|
| 2.5.1.7 | SSH session closing behavior..... | 85 |
| 2.5.1.8 | CLI and SNMP considerations..... | 85 |
| 2.5.2 | Exponential login backoff..... | 85 |
| 2.5.3 | User lockout..... | 86 |
| 2.5.4 | CLI login scripts..... | 87 |
| 2.5.5 | File access controls..... | 87 |
| 2.5.6 | 802.1x network access control..... | 90 |
| 2.5.7 | TCP Enhanced Authentication Option..... | 91 |
| 2.5.7.1 | Packet formats..... | 91 |
| 2.5.7.2 | Keychain..... | 92 |
| 2.5.8 | gRPC authentication..... | 95 |
| 2.5.9 | Hash management per management interface configuration..... | 97 |
| 2.5.9.1 | Hash encryption using AES-256..... | 97 |
| 2.5.9.2 | Cleartext..... | 97 |
| 2.6 | Configuring security with CLI..... | 97 |
| 2.6.1 | Configuring management access filters..... | 97 |
| 2.6.2 | Configuring IP CPM filters..... | 99 |
| 2.6.3 | Configuring IPv6 CPM filters..... | 101 |
| 2.6.4 | Configuring MAC CPM filters..... | 105 |
| 2.6.5 | Configuring CPM queues..... | 106 |
| 2.6.6 | IPsec certificate configuration..... | 106 |
| 2.6.7 | Configuring local command authorization profiles..... | 109 |
| 2.6.7.1 | Matching on values in command authorization rules..... | 110 |
| 2.6.7.2 | Using wildcards in command authorization value matching..... | 112 |
| 2.6.7.3 | CLI session resource management..... | 113 |
| 2.6.8 | Configuring local users..... | 115 |
| 2.6.9 | Configuring keychains..... | 116 |
| 2.6.10 | Copying and overwriting local user and profiles..... | 117 |
| 2.6.10.1 | Local users..... | 117 |
| 2.6.10.2 | Local user profiles..... | 118 |
| 2.6.11 | RADIUS configurations..... | 119 |
| 2.6.11.1 | Configuring RADIUS authentication..... | 119 |
| 2.6.11.2 | Configuring RADIUS authorization..... | 120 |
| 2.6.11.3 | Configuring RADIUS accounting..... | 120 |
| 2.6.12 | Configuring 802.1x RADIUS policies..... | 120 |
| 2.6.13 | TACACS+ configurations..... | 121 |

| | | |
|----------|---|------------|
| 2.6.13.1 | Enabling TACACS+ servers with authentication..... | 121 |
| 2.6.13.2 | Configuring TACACS+ authorization..... | 122 |
| 2.6.13.3 | Configuring TACACS+ accounting..... | 122 |
| 2.6.14 | LDAP configurations..... | 123 |
| 2.6.14.1 | Configuring LDAP authentication..... | 123 |
| 2.6.14.2 | Configuring redundant servers..... | 124 |
| 2.6.14.3 | Configuring login controls..... | 125 |
| 3 | Model-driven management interfaces..... | 127 |
| 3.1 | Management interface configuration modes..... | 128 |
| 3.2 | YANG data models..... | 130 |
| 3.2.1 | Nokia SR OS YANG data models..... | 130 |
| 3.2.2 | OpenConfig YANG data models..... | 132 |
| 3.2.2.1 | Basic configuration..... | 132 |
| 3.2.2.2 | OpenConfig state without OpenConfig configuration..... | 133 |
| 3.2.3 | Shared model management..... | 134 |
| 3.2.3.1 | Application support..... | 135 |
| 3.2.3.2 | Validating and committing a configuration..... | 136 |
| 3.2.3.3 | Displaying the configuration..... | 137 |
| 3.2.3.4 | Deviations and augments..... | 139 |
| 3.3 | Datstores and regions..... | 140 |
| 3.3.1 | NMDA support..... | 140 |
| 3.4 | SPC objects..... | 141 |
| 3.5 | Prerequisites for using model-driven management interfaces with classic configurations..... | 144 |
| 3.5.1 | Transitioning between modes..... | 144 |
| 3.5.2 | Configuring the CLI engine..... | 146 |
| 3.5.3 | Loose references to IDs..... | 147 |
| 3.5.4 | Strict routing policy validation..... | 151 |
| 3.5.5 | String names as keys..... | 151 |
| 3.6 | Commit history..... | 152 |
| 3.7 | Incremental saved configuration files..... | 154 |
| 3.8 | YANG-modeled operations..... | 156 |
| 3.8.1 | Asynchronous versus synchronous operations..... | 156 |
| 3.8.2 | Examples of operations in the MD-CLI..... | 158 |
| 3.8.3 | Examples of synchronous operations in NETCONF..... | 159 |
| 3.8.4 | Examples of asynchronous operations in NETCONF..... | 160 |

| | | |
|----------|--|------------|
| 4 | SNMP | 164 |
| 4.1 | SNMP overview..... | 164 |
| 4.1.1 | SNMP architecture..... | 164 |
| 4.1.2 | Management information base..... | 164 |
| 4.1.3 | SNMP protocol operations..... | 164 |
| 4.1.4 | SNMP versions..... | 165 |
| 4.1.5 | SNMPv3 authentication and privacy protocols..... | 165 |
| 4.1.6 | Management information access control..... | 165 |
| 4.1.7 | User-based security model community strings..... | 166 |
| 4.1.8 | Views..... | 166 |
| 4.1.9 | Access groups..... | 167 |
| 4.1.10 | Users..... | 167 |
| 4.1.11 | Per-VPRN logs and SNMP access..... | 168 |
| 4.1.12 | Per-SNMP community source IP address validation..... | 168 |
| 4.2 | SNMP versions..... | 168 |
| 4.3 | Best practices for SNMP information retrieval..... | 169 |
| 4.3.1 | SNMP GetBulkRequest..... | 170 |
| 4.3.2 | Queueing, RTT, and collection performance..... | 170 |
| 4.4 | Configuration notes..... | 171 |
| 4.4.1 | General..... | 171 |
| 4.5 | Configuring SNMP with CLI..... | 171 |
| 4.5.1 | SNMP configuration overview..... | 172 |
| 4.5.1.1 | Configuring SNMPv1 and SNMPv2c..... | 172 |
| 4.5.1.2 | Configuring SNMPv3..... | 172 |
| 4.5.2 | Basic SNMP security configuration..... | 172 |
| 4.5.3 | Configuring SNMP components..... | 174 |
| 4.5.3.1 | Configuring community strings..... | 175 |
| 4.5.3.2 | Configuring views..... | 175 |
| 4.5.3.3 | Configuring access groups..... | 176 |
| 4.5.3.4 | Configuring USM communities..... | 178 |
| 4.5.3.5 | Configuring other SNMP options..... | 178 |
| 5 | NETCONF | 180 |
| 5.1 | NETCONF overview..... | 180 |
| 5.2 | NETCONF in SR OS..... | 181 |

| | | |
|----------|---|-----|
| 5.2.1 | Transport and sessions..... | 181 |
| 5.2.2 | Datstores and URLs..... | 182 |
| 5.2.2.1 | Operational datastore..... | 183 |
| 5.2.3 | NETCONF operations and capabilities..... | 184 |
| 5.2.3.1 | <get>..... | 202 |
| 5.2.3.2 | <get-config>..... | 207 |
| 5.2.3.3 | <edit-config>..... | 216 |
| 5.2.3.4 | <copy-config>..... | 224 |
| 5.2.3.5 | <delete-config>..... | 226 |
| 5.2.3.6 | <lock>..... | 226 |
| 5.2.3.7 | <unlock>..... | 228 |
| 5.2.3.8 | <commit>..... | 229 |
| 5.2.3.9 | <discard-changes>..... | 232 |
| 5.2.3.10 | <validate>..... | 233 |
| 5.2.3.11 | <get-schema>..... | 234 |
| 5.2.3.12 | <get-data>..... | 235 |
| 5.2.4 | Datstore and operation combinations..... | 239 |
| 5.2.5 | Output format selection..... | 239 |
| 5.2.6 | Private candidates over NETCONF..... | 240 |
| 5.2.7 | General NETCONF behavior..... | 242 |
| 5.2.7.1 | Multiple use of standard NETCONF namespace..... | 242 |
| 5.2.7.2 | Non-default NETCONF base namespace..... | 243 |
| 5.2.7.3 | Invalid NETCONF namespace declaration..... | 244 |
| 5.2.7.4 | Non-default NETCONF namespace or prefix declaration in a child tag..... | 245 |
| 5.2.7.5 | Chunked frame mechanism..... | 245 |
| 5.2.8 | Establishing a NETCONF session..... | 246 |
| 5.2.8.1 | Checking NETCONF status..... | 247 |
| 5.2.8.2 | Retrieving system configurations, QoS, and log branches..... | 248 |
| 5.2.8.3 | Creating an Epipe service..... | 249 |
| 5.2.8.4 | Returning multiple errors..... | 249 |
| 5.3 | NETCONF notifications..... | 251 |
| 5.3.1 | NETCONF notification examples..... | 255 |
| 5.3.1.1 | Example of <create-subscription> operation..... | 255 |
| 5.3.1.2 | Example of sros-config-change-event notification..... | 256 |
| 5.3.1.3 | Example of sros-state-change-event notification..... | 256 |
| 5.3.1.4 | Example of sros-cli-accounting-event notification..... | 257 |

| | | |
|----------|--|------------|
| 5.3.1.5 | Example of sros-log-generic-event notification..... | 257 |
| 5.3.1.6 | Example of netconf-config-change notification..... | 258 |
| 5.3.1.7 | Example of sros-md-rpc-accounting-event notification..... | 258 |
| 5.4 | NETCONF monitoring..... | 259 |
| 5.4.1 | netconf-state schemas..... | 261 |
| 5.4.2 | netconf-state datastores..... | 262 |
| 5.4.3 | netconf-state sessions..... | 263 |
| 5.4.4 | netconf-state capabilities..... | 263 |
| 5.4.5 | netconf-state statistics..... | 263 |
| 5.5 | YANG library..... | 264 |
| 5.6 | Operational commands via NETCONF..... | 266 |
| 5.6.1 | Individually YANG-modeled operations..... | 267 |
| 5.6.1.1 | <md-compare> YANG-modeled operation..... | 268 |
| 5.6.1.2 | <pyexec> YANG-modeled operation..... | 273 |
| 5.6.2 | NETCONF operations using the md-cli-raw-command request..... | 275 |
| 6 | Python..... | 278 |
| 6.1 | Python overview..... | 278 |
| 6.2 | Python in SR OS..... | 278 |
| 6.2.1 | Prerequisites..... | 278 |
| 6.2.2 | YANG model support..... | 278 |
| 6.3 | Python 3 interpreter..... | 279 |
| 6.4 | Building an application..... | 279 |
| 6.4.1 | Available libraries..... | 279 |
| 6.4.2 | The pySROS API..... | 280 |
| 6.4.2.1 | Installing the pySROS libraries..... | 280 |
| 6.4.2.2 | Importing into applications..... | 281 |
| 6.4.2.3 | API documentation..... | 281 |
| 6.4.2.4 | Connecting to a model-driven SR OS device..... | 281 |
| 6.4.2.5 | Obtaining modeled data..... | 283 |
| 6.4.2.6 | Performing operations with pySROS..... | 283 |
| 6.4.2.7 | Editing configuration..... | 284 |
| 6.4.3 | The pySROS data structure..... | 285 |
| 6.5 | Provisioning and precompiling Python applications..... | 287 |
| 6.5.1 | Refreshing configured python scripts..... | 287 |
| 6.6 | Execution pathways..... | 287 |

| | | |
|----------|--|------------|
| 6.6.1 | Executing a Python application remotely..... | 287 |
| 6.6.2 | Executing a Python application from the command line..... | 288 |
| 6.6.2.1 | pyexec and input parameters..... | 288 |
| 6.6.2.2 | Executing a Python application as an output modifier..... | 288 |
| 6.6.2.3 | Chaining Python applications..... | 288 |
| 6.6.2.4 | Python applications and the MD-CLI pager..... | 289 |
| 6.6.3 | Executing Python applications with MD-CLI command aliases..... | 289 |
| 6.7 | Security..... | 289 |
| 6.7.1 | Python authentication and authorization..... | 289 |
| 6.7.1.1 | Authentication..... | 290 |
| 6.7.1.2 | Authorization..... | 290 |
| 6.7.2 | Other restrictions..... | 290 |
| 6.7.3 | Memory management..... | 290 |
| 6.7.4 | Performance and scale..... | 290 |
| 7 | Event and accounting logs..... | 291 |
| 7.1 | Logging overview..... | 291 |
| 7.2 | Log destinations..... | 292 |
| 7.2.1 | Console..... | 292 |
| 7.2.2 | Session..... | 292 |
| 7.2.3 | CLI logs..... | 293 |
| 7.2.4 | Memory logs..... | 293 |
| 7.2.5 | Log and accounting files..... | 293 |
| 7.2.5.1 | Log file encryption..... | 295 |
| 7.2.6 | SNMP trap group..... | 296 |
| 7.2.7 | Syslog..... | 296 |
| 7.2.7.1 | Syslog implementation overview..... | 296 |
| 7.2.7.2 | Syslog over TLS for log events..... | 300 |
| 7.2.8 | NETCONF..... | 300 |
| 7.3 | Event logs..... | 301 |
| 7.3.1 | Event sources..... | 301 |
| 7.3.2 | Event control..... | 302 |
| 7.3.3 | Log manager and event logs..... | 304 |
| 7.3.4 | Event filter policies..... | 304 |
| 7.3.5 | Event log entries..... | 305 |
| 7.3.6 | Simple logger event throttling..... | 307 |

| | | |
|---------|---|-----|
| 7.3.7 | Default system log..... | 307 |
| 7.3.8 | Event handling system..... | 308 |
| 7.3.8.1 | EHS configuration and variables..... | 310 |
| 7.3.8.2 | Triggering a CLI script from EHS..... | 311 |
| 7.3.8.3 | Triggering a Python application from EHS..... | 315 |
| 7.3.8.4 | EHS debounce..... | 317 |
| 7.3.8.5 | Executing EHS or CRON CLI scripts or Python applications..... | 318 |
| 7.3.9 | Managing logging in VPRNs..... | 319 |
| 7.4 | Customizing syslog messages using Python..... | 319 |
| 7.4.1 | Python engine for syslog..... | 320 |
| 7.4.1.1 | Python 2 syslog APIs..... | 321 |
| 7.4.1.2 | Python 3 syslog APIs..... | 323 |
| 7.4.1.3 | Timestamp format manipulation in Python 2..... | 325 |
| 7.4.1.4 | Timestamp format manipulation in Python 3..... | 326 |
| 7.4.2 | Python processing efficiency..... | 326 |
| 7.4.3 | Python backpressure..... | 326 |
| 7.4.4 | Selecting events for Python processing..... | 326 |
| 7.5 | Accounting logs..... | 329 |
| 7.5.1 | Accounting records..... | 329 |
| 7.5.2 | Accounting files..... | 348 |
| 7.5.3 | Design considerations for accounting policies..... | 348 |
| 7.5.4 | Reporting and time-based accounting..... | 349 |
| 7.5.5 | Custom record usage for overhead reduction in accounting..... | 349 |
| 7.5.5.1 | User configurable records..... | 349 |
| 7.5.5.2 | Changed statistics only..... | 349 |
| 7.5.5.3 | Configurable accounting records..... | 349 |
| 7.5.5.4 | Significant change only reporting..... | 364 |
| 7.5.6 | Immediate completion of records..... | 364 |
| 7.5.6.1 | Record completion for XML accounting..... | 365 |
| 7.5.7 | AA accounting per forwarding class..... | 365 |
| 7.6 | Configuration notes..... | 365 |
| 7.7 | Configuring logging with CLI..... | 365 |
| 7.7.1 | Log configuration overview..... | 365 |
| 7.7.2 | Log types..... | 366 |
| 7.7.3 | Basic log configuration..... | 366 |
| 7.7.4 | Common configuration tasks..... | 367 |

| | | |
|----------|--|------------|
| 7.7.4.1 | Configuring an event log..... | 368 |
| 7.7.4.2 | Configuring a log file policy..... | 368 |
| 7.7.4.3 | Configuring an accounting policy..... | 369 |
| 7.7.4.4 | Configuring an accounting custom record..... | 370 |
| 7.7.4.5 | Configuring event control..... | 373 |
| 7.7.4.6 | Configuring a log filter..... | 373 |
| 7.7.4.7 | Configuring an SNMP trap group..... | 375 |
| 7.7.4.8 | Configuring a syslog target..... | 381 |
| 7.7.4.9 | Modifying a log file..... | 381 |
| 7.7.4.10 | Deleting a log file..... | 383 |
| 7.7.4.11 | Modifying a log file ID..... | 384 |
| 7.7.4.12 | Modifying a syslog ID..... | 385 |
| 7.7.4.13 | Deleting an SNMP trap group..... | 386 |
| 7.7.4.14 | Modifying a log filter..... | 386 |
| 7.7.4.15 | Modifying event control configuration..... | 388 |
| 7.7.4.16 | Returning to the default event control configuration..... | 389 |
| 8 | Node discovery provisioning using OSPF..... | 391 |
| 8.1 | Node discovery procedure..... | 391 |
| 8.1.1 | Configuring network element profiles..... | 391 |
| 8.1.2 | Advertising an NE profile using OSPF..... | 392 |
| 8.1.3 | OSPFv2 opaque LSA requirements..... | 394 |
| 8.1.4 | IPv4/IPv6..... | 395 |
| 8.2 | Auto-provisioning using OSPF..... | 395 |
| 8.2.1 | NEID..... | 395 |
| 8.2.2 | NEIP..... | 395 |
| 8.2.3 | NEIP and NEID autogenerate CLI configuration..... | 396 |
| 8.2.4 | Auto-provisioning using OSPF..... | 396 |
| 8.2.4.1 | Autogenerate configuration..... | 396 |
| 8.2.4.2 | The auto-boot ospf flag and options..... | 397 |
| 8.2.4.3 | CLI generation of the loopback address and router ID using auto-boot ospf options..... | 398 |
| 8.2.4.4 | Connectivity requirements..... | 400 |
| 8.2.4.5 | Auto-provisioning success..... | 400 |
| 8.2.4.6 | Auto-boot OSPF reboot timers..... | 400 |
| 8.2.4.7 | Auto-boot OSPF relation with auto-boot..... | 400 |

| | | |
|-----------|--|------------|
| 8.2.4.8 | Auto-provisioning log options..... | 400 |
| 8.2.4.9 | Console access during auto-provisioning..... | 401 |
| 8.2.4.10 | Disabling OSPF auto-provisioning..... | 401 |
| 8.2.5 | CLI structure..... | 401 |
| 8.2.5.1 | Assigning the NE-discovery profile to IGP..... | 401 |
| 8.3 | Aggregation node configuration..... | 401 |
| 8.3.1 | MIB requirements on the aggregation node..... | 402 |
| 8.3.2 | SNMP traps and gets..... | 404 |
| 9 | Public key infrastructure..... | 405 |
| 9.1 | X.509v3 certificate overview..... | 405 |
| 9.1.1 | SR OS X.509v3 certificate support..... | 405 |
| 9.1.2 | Local storage..... | 406 |
| 9.1.3 | CA-profile..... | 406 |
| 9.1.4 | CA chain computation..... | 407 |
| 9.1.5 | Certificate enrollment..... | 407 |
| 9.1.6 | Certificate revocation check..... | 408 |
| 9.1.7 | Certificate/CRL expiration warning..... | 409 |
| 9.1.8 | Certificate/CRL/key cache..... | 409 |
| 9.1.9 | Auto CRL update..... | 410 |
| 9.1.10 | CMPv2..... | 411 |
| 9.1.11 | Encryption of imported files..... | 411 |
| 9.1.12 | Enrollment over secure transport..... | 412 |
| 9.1.13 | OCSP..... | 413 |
| 9.1.14 | Auto update certificate..... | 414 |
| 10 | sFlow..... | 416 |
| 10.1 | sFlow overview..... | 416 |
| 10.2 | sFlow features..... | 416 |
| 10.2.1 | sFlow counter polling architecture..... | 416 |
| 10.2.2 | sFlow support on logical Ethernet ports..... | 417 |
| 10.2.3 | sFlow SAP counter map..... | 417 |
| 10.2.4 | sFlow record formats..... | 418 |
| 11 | gRPC..... | 421 |
| 11.1 | Security aspects..... | 421 |

| | | |
|----------|---|-----|
| 11.1.1 | TLS-based encryption..... | 421 |
| 11.1.2 | Certificate revocation check with TLS..... | 422 |
| 11.1.3 | Authentication..... | 422 |
| 11.2 | gNMI service..... | 424 |
| 11.2.1 | gNMI service definitions..... | 424 |
| 11.2.1.1 | Capability discovery..... | 424 |
| 11.2.1.2 | Get/Set RPC..... | 425 |
| 11.2.1.3 | Subscribe RPC..... | 426 |
| 11.2.1.4 | Publish RPC..... | 431 |
| 11.2.1.5 | Schema paths..... | 431 |
| 11.2.2 | gNMI service use cases..... | 433 |
| 11.2.2.1 | Telemetry..... | 433 |
| 11.2.2.2 | NE configuration management..... | 444 |
| 11.3 | gNOI services..... | 445 |
| 11.3.1 | Certificate management for TLS connections..... | 446 |
| 11.3.1.1 | RPC GetCertificates..... | 446 |
| 11.3.1.2 | RPC CanGenerateCSR..... | 447 |
| 11.3.1.3 | RPC Rotate..... | 447 |
| 11.3.1.4 | RPC Install..... | 451 |
| 11.3.1.5 | RPC RevokeCertificates..... | 453 |
| 11.4 | gNOI system..... | 453 |
| 11.4.1 | SetPackage RPC..... | 454 |
| 11.4.2 | Reboot, CancelReboot, and RebootStatus RPC..... | 454 |
| 11.4.3 | SwitchControlProcessor RPC..... | 454 |
| 11.4.4 | Ping RPC..... | 454 |
| 11.4.5 | Time RPC..... | 454 |
| 11.4.6 | Traceroute RPC..... | 455 |
| 11.5 | MD-CLI service..... | 455 |
| 11.5.1 | Remote management using a remote network interface shell manager..... | 455 |
| 11.6 | gNOI file..... | 456 |
| 11.6.1 | Get RPC..... | 456 |
| 11.6.2 | Put RPC..... | 457 |
| 11.6.3 | Stat RPC..... | 457 |
| 11.6.4 | Remove RPC..... | 457 |
| 11.6.5 | TransferToRemote RPC..... | 457 |

| | | |
|-----------|--|------------|
| 12 | gRPC tunnels | 458 |
| 12.1 | gRPC tunnels in SR OS | 459 |
| 12.1.1 | gRPC tunnel architecture in SR OS | 459 |
| 12.1.2 | gRPC tunnel security | 459 |
| 12.1.3 | Configuring a gRPC tunnel in SR OS | 460 |
| 12.1.4 | Verifying gRPC tunnel operation | 461 |
| 13 | TLS | 463 |
| 13.1 | TLS overview | 463 |
| 13.2 | TLS server interaction with applications | 463 |
| 13.2.1 | TLS application support | 464 |
| 13.3 | TLS handshake | 464 |
| 13.4 | TLS 1.3 | 465 |
| 13.4.1 | TLS 1.3 handshake | 466 |
| 13.4.2 | TLS 1.3 configuration | 466 |
| 13.5 | TLS client certificate | 466 |
| 13.6 | Certificate revocation status verification for TLS | 466 |
| 13.7 | TLS symmetric key rollover | 467 |
| 13.8 | Supported TLS ciphers | 467 |
| 13.9 | SR OS certificate management | 468 |
| 13.9.1 | Certificate profile | 469 |
| 13.9.2 | TLS server authentication of the client certificate CN field | 469 |
| 13.9.3 | CN regexp format | 469 |
| 13.10 | Operational guidelines | 469 |
| 13.10.1 | Server authentication behavior | 469 |
| 13.10.2 | Client TLS profile and trust anchor behavior and scale | 470 |
| 13.11 | LDAP redundancy and TLS | 470 |
| 13.12 | Basic TLS configuration | 472 |
| 13.13 | Common configuration tasks | 473 |
| 13.13.1 | Configuring a server TLS profile | 474 |
| 13.13.2 | Configuring a client TLS profile | 474 |
| 13.13.3 | Configuring a TLS client or TLS server certificate | 474 |
| 13.13.4 | Configuring a TLS trust anchor | 474 |
| 14 | Facility alarms | 476 |

| | | |
|-----------|---|------------|
| 14.1 | Facility alarms overview..... | 476 |
| 14.2 | Facility alarms versus log events..... | 476 |
| 14.3 | Facility alarm severities and alarm LED behavior..... | 477 |
| 14.4 | Facility alarm hierarchy..... | 478 |
| 14.5 | Facility alarm list..... | 478 |
| 14.6 | Configuring facility alarms with CLI..... | 498 |
| 14.6.1 | Enabling facility alarms..... | 498 |
| 14.6.2 | Common configuration tasks..... | 498 |
| 14.6.2.1 | Configuring the maximum number of alarms to clear..... | 498 |
| 15 | Standards and protocol support..... | 500 |
| 15.1 | Access Node Control Protocol (ANCP)..... | 500 |
| 15.2 | Bidirectional Forwarding Detection (BFD)..... | 500 |
| 15.3 | Border Gateway Protocol (BGP)..... | 500 |
| 15.4 | Bridging and management..... | 502 |
| 15.5 | Broadband Network Gateway (BNG) Control and User Plane Separation (CUPS)..... | 503 |
| 15.6 | Certificate management..... | 503 |
| 15.7 | Circuit emulation..... | 504 |
| 15.8 | Ethernet..... | 504 |
| 15.9 | Ethernet VPN (EVPN)..... | 504 |
| 15.10 | gRPC Remote Procedure Calls (gRPC)..... | 505 |
| 15.11 | Intermediate System to Intermediate System (IS-IS)..... | 505 |
| 15.12 | Internet Protocol (IP) Fast Reroute (FRR)..... | 506 |
| 15.13 | Internet Protocol (IP) general..... | 506 |
| 15.14 | Internet Protocol (IP) multicast..... | 508 |
| 15.15 | Internet Protocol (IP) version 4..... | 509 |
| 15.16 | Internet Protocol (IP) version 6..... | 510 |
| 15.17 | Internet Protocol Security (IPsec)..... | 511 |
| 15.18 | Label Distribution Protocol (LDP)..... | 512 |
| 15.19 | Layer Two Tunneling Protocol (L2TP) Network Server (LNS)..... | 513 |
| 15.20 | Multiprotocol Label Switching (MPLS)..... | 513 |
| 15.21 | Multiprotocol Label Switching - Transport Profile (MPLS-TP)..... | 514 |
| 15.22 | Network Address Translation (NAT)..... | 514 |
| 15.23 | Network Configuration Protocol (NETCONF)..... | 515 |
| 15.24 | Open Shortest Path First (OSPF)..... | 515 |
| 15.25 | OpenFlow..... | 516 |

| | | |
|-------|--|-----|
| 15.26 | Path Computation Element Protocol (PCEP)..... | 516 |
| 15.27 | Point-to-Point Protocol (PPP)..... | 516 |
| 15.28 | Policy management and credit control..... | 517 |
| 15.29 | Pseudowire (PW)..... | 517 |
| 15.30 | Quality of Service (QoS)..... | 518 |
| 15.31 | Remote Authentication Dial In User Service (RADIUS)..... | 518 |
| 15.32 | Resource Reservation Protocol - Traffic Engineering (RSVP-TE)..... | 518 |
| 15.33 | Routing Information Protocol (RIP)..... | 519 |
| 15.34 | Segment Routing (SR)..... | 519 |
| 15.35 | Simple Network Management Protocol (SNMP)..... | 520 |
| 15.36 | Timing..... | 523 |
| 15.37 | Two-Way Active Measurement Protocol (TWAMP)..... | 523 |
| 15.38 | Virtual Private LAN Service (VPLS)..... | 523 |
| 15.39 | Voice and video..... | 524 |
| 15.40 | Wireless Local Area Network (WLAN) gateway..... | 524 |
| 15.41 | Yet Another Next Generation (YANG)..... | 524 |
| 15.42 | Yet Another Next Generation (YANG) OpenConfig Models..... | 524 |

1 Getting started

1.1 About this guide

This guide describes system concepts and provides configuration explanations and examples to configure SR OS boot option file (BOF), file system and system management functions.

This guide is organized into functional chapters and provides concepts and descriptions of the implementation flow, as well as Command Line Interface (CLI) syntax and command usage.



Note: Unless otherwise indicated, CLI commands, contexts, and configuration examples in this guide apply for both the MD-CLI and the classic CLI.

The topics and commands described in this document apply to the:

- 7450 ESS
- 7750 SR
- 7950 XRS
- Virtualized Service Router

For a list of unsupported features by platform and chassis, see the *SR OS R23.x.Rx Software Release Notes*, part number 3HE 19269 000 x TQZZA.

Command outputs shown in this guide are examples only; actual displays may differ depending on supported functionality and user configuration.



Note:

The SR OS CLI trees and command descriptions can be found in the following guides:

- *7450 ESS, 7750 SR, 7950 XRS, and VSR Classic CLI Command Reference Guide*
- *7450 ESS, 7750 SR, 7950 XRS, and VSR Clear, Monitor, Show, and Tools Command Reference Guide* (for both the MD-CLI and the classic CLI)
- *7450 ESS, 7750 SR, 7950 XRS, and VSR MD-CLI Command Reference Guide*



Note:

This guide generically covers Release 23.x.Rx content and may contain some content that will be released in later maintenance loads. See the *SR OS R23.x.Rx Software Release Notes*, part number 3HE 19269 000 x TQZZA, for information about features supported in each load of the Release 23.x.Rx software.

1.2 System configuration process

[Table 1: Configuration process](#) lists the tasks necessary to configure system security and access functions and logging features on the 7450 ESS, 7750 SR, and 7950 XRS platforms. Each chapter in this book is presented in an overall logical configuration flow. Each section describes a software area and the CLI command usage to configure the functional area.

Table 1: Configuration process

| Area | Task | Section |
|---------------------------|-------------------------------------|--|
| System security | Configure system security | Configuring security with CLI |
| | Configure RADIUS | RADIUS configurations |
| | Configure TACACS+ | TACACS+ configurations |
| | Configure LDAP | LDAP configurations |
| | Configure login controls | Configuring login controls |
| Network management | Configure SNMP elements | Configuring SNMP with CLI |
| Secure network management | Configure NETCONF elements | NETCONF |
| Operational functions | Configure event and accounting logs | Configuring logging with CLI |
| Data management | Configure sFlow elements | sFlow |
| Network monitoring | Configure telemetry | gRPC gRPC tunnels |
| Network security | Configure TLS server and client | Common configuration tasks |
| Equipment monitoring | Configure facility alarms | Configuring facility alarms with CLI |



Note: All features are supported on all SR OS platforms (7750 SR, 7450 ESS, and 7950 XRS) unless indicated otherwise.

1.3 Node management using VPRN

While customarily node management is operated either via the out-of-band interface or in-band via the Base routing instance, it is also possible to manage the node using a VPRN. Both IPv4 and IPv6 are supported.

The following management plane clients are supported using VPRN:

- DNS
- gRPC (dial-out telemetry)
- RADIUS
- SNMP (traps)
- SSH
- Syslog
- TACACS+
- Telnet

The following servers are supported using VPRN:

- FTP
- gRPC
- NETCONF (including notifications)
- SNMP
- SSH
- Telnet

For more details, see the *7450 ESS, 7750 SR, 7950 XRS, and VSR Layer 3 Services Guide: IES and VPRN, "Node management using VPRN"*.

1.4 Conventions

This section describes the general conventions used in this guide.

1.4.1 Precautionary and information messages

The following information symbols are used in the documentation.



DANGER: Danger warns that the described activity or situation may result in serious personal injury or death. An electric shock hazard could exist. Before you begin work on this equipment, be aware of hazards involving electrical circuitry, be familiar with networking environments, and implement accident prevention procedures.



WARNING: Warning indicates that the described activity or situation may, or will, cause equipment damage, serious performance problems, or loss of data.



Caution: Caution indicates that the described activity or situation may reduce your component or system performance.



Note: Note provides additional operational information.



Tip: Tip provides suggestions for use or best practices.

1.4.2 Options or substeps in procedures and sequential workflows

Options in a procedure or a sequential workflow are indicated by a bulleted list. In the following example, at step 1, the user must perform the described action. At step 2, the user must perform one of the listed options to complete the step.

Example: Options in a procedure

1. User must perform this step.
2. This step offers three options. User must perform one option to complete this step.
 - This is one option.

- This is another option.
- This is yet another option.

Substeps in a procedure or a sequential workflow are indicated by letters. In the following example, at step 1, the user must perform the described action. At step 2, the user must perform two substeps (a. and b.) to complete the step.

Example: Substeps in a procedure

1. User must perform this step.
2. User must perform all substeps to complete this action.
 - a. This is one substep.
 - b. This is another substep.

2 Security

2.1 Authentication, authorization, and accounting

This chapter describes authentication, authorization, and accounting (AAA) used to monitor and control network access on routers. Network security is based on a multi-step process. The first step, authentication, validates a user's credentials. The second step, authorization, allows the user to access and execute commands at various command levels based on profiles assigned to the user.

The third step, accounting, keeps track of the activity of users who have accessed the network. The type of accounting information recorded can include a history of the commands executed, the amount of time spent in the session, the services accessed, and the data transfer size during the session. The accounting data can be used for trend analysis, billing, and auditing purposes.

Configure routers to use local, Remote Authentication Dial In User Service (RADIUS), Lightweight Directory Access Protocol (LDAP), or Terminal Access Controller Access Control System Plus (TACACS+) security to validate users who attempt to access the router by console, Telnet, SSH, NETCONF, FTP, and more. Select the authentication order, which determines the authentication method to try first, second, third, or fourth.

The router supports the following security features:

- local security can be implemented for authentication and authorization
- LDAP can be implemented for authentication in the Base routing instance
- RADIUS can be used for authentication, authorization, and accounting in the Base routing instance or a VPRN
- TACACS+ can be used for authentication, authorization, and accounting in the Base routing instance or a VPRN

The following figure depicts end user access-requests sent to a RADIUS server. After validating the usernames and passwords, the RADIUS server returns an access-accept message to the users on ALA-1 and ALA-2. The username and password from ALA-3 could not be authenticated; therefore, access was denied.

Figure 1: RADIUS requests and responses

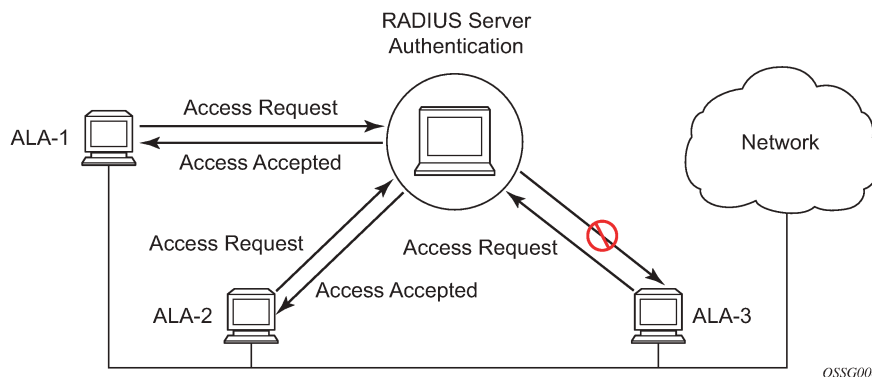

2.1.1 Authentication

Authentication validates a user's credentials when a user attempts to log in.

When a user attempts to log in through the console, FTP, or other methods, the client sends credentials to the router. Based on the received credentials, the router creates and sends an authentication request to a RADIUS, TACACS+, LDAP, or local database. The order in which the router tries different types of AAA servers and local databases is defined by the configured authentication order.

Transactions between the router and a RADIUS or TACACS+ server are authenticated through the use of a shared secret. The secret is never transmitted over the network. TLS can be used for the connection between the router and the LDAP or RADIUS server. User passwords are sent encrypted between the client and the AAA (RADIUS, TACACS+, or LDAP) server which prevents someone snooping on an insecure network to learn password information.

If the AAA server (of the chosen authentication method) does not respond within a specified time, the router issues the access request to the next configured servers of the same authentication method. Each AAA server must be configured identically to guarantee consistent results.

If any AAA server rejects the authentication request, it sends an access reject message to the router. In this case, no access request is issued to any other AAA servers of the chosen authentication method. However, if other authentication methods, such as TACACS+ and/or local, are configured and the **exit-on-reject** option is not set, then these methods are attempted. If no other authentication methods are configured, or all methods reject the authentication request, then access is denied.

For the AAA server selection, round-robin is used if multiple AAA servers for one particular authentication method are configured. Although, if the first alive server in the list cannot find a username, the router does not re-query the next server in the AAA server list for that authentication method and denies the access request. It may get authenticated on the next login attempt if the next selected AAA server has the appropriate username. It is recommended that the same user databases are maintained for AAA servers to avoid inconsistent behavior.

The user login is successful when the AAA server accepts the authentication request and responds to the router with an access accept message.

Implementing authentication without authorization for the routers does not require the configuration of VSAs (Vendor Specific Attributes) on the RADIUS server. However, users, user access permissions, and command authorization profiles must be configured on each router.

Any combination of these authentication methods can be configured to control network access from a router:

- [Local authentication](#)
- [RADIUS authentication](#)
- [TACACS+ authentication](#)
- [LDAP authentication](#)



Note: Multi-factor authentication (MFA) is not supported for local users, but is supported with a RADIUS AAA server that provides MFA functionality for remote users.

2.1.1.1 Local authentication

Local authentication uses PKI or usernames and passwords as authentication credentials to authenticate login attempts. The authentication credentials are local to each router, not to user profiles.

By default, local authentication is enabled. When one or more of the other security methods are enabled, local authentication is used in case it is configured as first method in the authentication order, or if other authentication methods are configured before local in the authentication order and fail.

Locally, usernames, public keys, and password management information can be configured. This is referred to as local authentication.

2.1.1.2 RADIUS authentication

Remote Authentication Dial-In User Service (RADIUS) is a client/server security protocol and software that enables remote access servers to communicate with a central server to authenticate dial-in users and authorize access to the requested system or service.

RADIUS allows administrators to maintain user profiles in a shared central database and provides better security, allowing a company to set up a policy that can be applied at a single administered network point.

2.1.1.2.1 RADIUS server selection

The RADIUS server selection algorithm is used by different applications:

- RADIUS operator management
- RADIUS authentication for Enhanced Subscriber Management
- RADIUS accounting for Enhanced Subscriber Management
- RADIUS PE-discovery

In all these applications, up to five RADIUS servers pools (per RADIUS policy, if used) can be configured.

The RADIUS server selection algorithm can work in 2 modes, either Direct mode or Round-robin mode.

2.1.1.2.1.1 Direct mode

The first server is used as the primary server. If this server is unreachable, the next server, based on the server index, of the server pool is used. This continues until either all servers in the pool have been tried or an answer is received.

If a server is unreachable, it will not be used again by the RADIUS application for the next 30 seconds to allow the server to recover from its unreachable state. After 30 seconds the unreachable server is available again for the RADIUS application. If in these 30 seconds the RADIUS application receives a valid response for a previously sent RADIUS packet on that unreachable server, the server will be available for the RADIUS application again, immediately after reception of that response.

2.1.1.2.1.2 Round-robin mode

The RADIUS application sends the next RADIUS packet to the next server in the server pool. The same server non-reachability behavior is valid as in the Direct mode.

2.1.1.2.1.3 Server reachability detection

A server is reachable, when the operational state UP, when a valid response is received within a timeout period which is configurable by the retry parameter on the RADIUS policy level.

A server is treated as not-reachable, if the operational state is down when the following occurs:

- **a timeout**

If a number of consecutive timeouts are encountered for a specific server. This number is configurable by the retry parameter on RADIUS policy level.

- **a send failed**

If a packet cannot be sent to the RADIUS server because the forwarding path toward the RADIUS server is broken (for example, the route is not available, the interface is shutdown, and so on), then, no retry mechanism is invoked and immediately, the next server in line is used.

A server that is down can only be used again by the RADIUS algorithm after 30 seconds, unless, during these 30 seconds a valid RADIUS reply is received for that server. Then, the server is immediately marked UP again.

The operational state of a server can also be "unknown" if the RADIUS application is not aware of the state of the RADIUS server (for example, if the server was previously down but no requests had been sent to the server, therefore, it is not specified yet whether the server is actually reachable).

2.1.1.2.1.4 Application-specific operator management

By default, the server access mode is Direct, but it can be changed into Round-Robin. A health-check function is available for operator management, which can optionally be disabled. The health-check polls the server every 30 seconds (configurable) with an improbable username. If the server does not respond to this health-check, it is marked down.

If the first server in the list cannot find a user, the next server in the RADIUS server list is queried, only when access mode is set to Round-Robin. If multiple RADIUS servers are used and access mode is set to Direct, it is assumed they all have the same user database.

2.1.1.2.1.5 Application-specific RADIUS authentication

If the first server in the list cannot find a user, the next server in the RADIUS server list is not queried and access is denied. If multiple RADIUS servers are used, it is assumed they all have the same user database.

2.1.1.2.1.6 Application-specific RADIUS challenge/response interactive authentication

Challenge-response interactive authentication is used for key authentication where the RADIUS server is asking for the valid response to a displayed challenge. The challenge packet includes a challenge to be displayed to the user, such as a unique generated numeric value unlikely ever to be repeated. Typically this is obtained from an external server that knows what type of authenticator is in the possession of the authorized user and can therefore choose a random or non-repeating pseudorandom number of appropriate length.

The user then enters the challenge into his device (or software) and it calculates a response, which the user enters into the client which forwards it to the RADIUS server within an access request. If the response matches the expected response, the RADIUS server allows the user access, otherwise it rejects the response.

Use the following command to enable RADIUS challenge/response mode:

- **MD-CLI**

```
configure system security aaa remote-servers radius interactive-authentication
```

- **classic CLI**

```
configure system security radius interactive-authentication
```

RADIUS interactive authentication is disabled by default. The option needs to be enabled using CLI. Enabling interactive authentication under CLI does not mean that the system uses RADIUS challenge/response mode by default. The configured password authentication-order option is used. If the authentication-order option is local RADIUS, the system will first attempt to login the user using local authentication. If this fails, the system will revert to RADIUS and challenge/response mode. The authentication-order will precede the RADIUS interactive-authentication mode.

Even if the authentication-order is RADIUS local, the standard password prompt is always displayed. The user enters a username and password at this prompt. If RADIUS interactive-authentication is enabled the password does not have to be the correct password because authentication is accomplished using the RADIUS challenge/response method. The user can enter any password. The username and password are sent to the RADIUS server, which responds with a challenge request that is transmitted back to the node by the RADIUS server. When the user enters the challenge response, the response is authenticated by the RADIUS server to allow node access to the user.

For example, if the system is configured with system security authentication-order set to local RADIUS, at the login prompt the user can enter the username "admin" and the corresponding password. If the password for local authentication does not match, the system falls into RADIUS authentication mode. The system checks the interactive-authentication configuration and if it is enabled it enters into challenge/response mode. It sends the username and password to the RADIUS server, and the server sends the challenge request back to the node and to the user where it appears as a challenge prompt on screen. A challenge received from the RADIUS server typically contains a string and a hardware token that can be used to generate a password on the users' local personal token generator. For example, the RADIUS

server may send the challenge prompt "Enter response for challenge 12345:" to the SR OS. The string "12345" can be entered in the local token generator which generates the appropriate challenge response for the entered string. This challenge response can then be entered on the SR OS prompt for authorization.

When the user enters the correct challenge response it is authenticated using the RADIUS server. The server authenticates the user and the user gains access to the node.

If session timeout and Idle timeout values are configured on the RADIUS server, these are used to govern the length of time before the SR OS cancels the challenge prompt. If the user is idle longer than the received idle-timeout (seconds) from the RADIUS server, and/or if the user does not press ENTER before the received session-timeout (seconds).



Note: For SSH only the session-timeout value is used. The SSH stack cannot track character input into the login prompt until the enter key is pressed.

If the idle/session attribute is not available or if the value is set to a very large number, the SR OS uses the smallest value set in "configure system login-control idle-timeout" and the idle/session timeout attribute value to terminate the prompt. If the "login-control idle-timeout" is disabled, the maximum idle-timeout (24-hours) is used for the calculation.

The SR OS displays the log-in attempts/failure per user in the "show system security user username" screen. If the RADIUS rejects a challenge response, it counts as a failed login attempt and a new prompt is displayed. The number of failed attempts is limited by the value set for "configure system security password attempt." An incorrect challenge response results in a failure count against the password attempts.

2.1.1.2.1.7 Application-specific RADIUS accounting

RADIUS accounting can be used for two purposes:

- CLI command accounting
- Enhanced Subscriber Management subscriber host accounting

The RADIUS accounting application tries to send all the accounting records of a subscriber host to the same RADIUS server. If that server is down, then the records are sent to the next server, and from that moment on, the RADIUS application uses that server as the destination for accounting records for that subscriber host. Enhanced Subscriber Management applies to the 7750 SR platform.

2.1.1.2.1.8 Application-specific RADIUS PE-discovery

If the first server in the list cannot find a user, the next server in the RADIUS server list is not queried and access is denied. If multiple RADIUS servers are used, it is assumed they all have the same user database.

The RADIUS PE-discovery application makes use of a 10 second time period instead of the generic 30 seconds and uses a fixed consecutive timeout value of 2 (see [Server reachability detection](#)).

As long as the Session-Timeout (attribute in the RADIUS user file) is specified, it is used for the polling interval. Otherwise, the configured polling interval is used (60 seconds by default).

2.1.1.3 TACACS+ authentication

Terminal Access Controller Access Control System (TACACS) is an authentication protocol that allows a remote access server to forward a user's login password to an authentication server to determine whether access can be allowed to a specific system. TACACS is an encryption protocol and therefore less secure than the later Terminal Access Controller Access Control System Plus (TACACS+) and RADIUS protocols.

TACACS+ and RADIUS have largely replaced earlier protocols in the newer or recently updated networks. TACACS+, which uses Transmission Control Protocol (TCP), is popular because TCP is thought to be a more reliable protocol. RADIUS combines authentication and authorization. TACACS+ separates these operations.

2.1.1.4 LDAP authentication

Lightweight Directory Access Protocol (LDAP) can provide authentication, authorization, accounting (AAA) functionality, and can allow users to access the full virtualized data center and networking devices. SR OS currently supports LDAP provision of a centralized authentication method with public key management. The authentication method is based on SSH public keys or keyboard authentication (username, password).

Administrators can access networking devices with one private key; public keys are usually saved locally on the SSH server. Proper key management is not feasible with locally-saved public keys on network devices or on virtual machines, as this would result in hundreds of public keys distributed on all devices. LDAPv3 provides a centralized key management system that allows for secure creation and distribution of public keys in the network. Public keys can be remotely saved on the LDAP server, which makes key management much easier, as shown in [Figure 2: Key management](#).

Figure 2: Key management

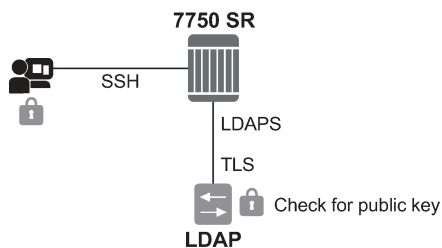

The administrator starts an SSH session through an SSH client using their private key. The SSH client for the authentication method sends a signature created with the user's private key to the router. The router authenticates the signature using the user's public key and gives access to the user. To access the public key, the router looks up the public key stored on the LDAP server and the public key stored locally. The order in which the public keys are looked up is defined by the authentication order. Communication between the router and the LDAP server should be secured with LDAP over SSL/TLS (LDAPS). After successfully opening a secured connection, LDAP returns a set of public keys that can be used by the router to verify the signature.

LDAP is integrated into the SR OS as an AAA protocol alongside existing AAA protocols, such as RADIUS and TACACS+. The AAA framework provides tools and mechanisms (such as method lists, server groups, and generic attribute lists) that enable an abstract and uniform interface to AAA clients, irrespective of the actual protocol used for communication with the AAA server.

The authentication functions are:

- **public key authentication**

The client tries to SSH to the SR OS using public keys.

Public keys can be stored locally or on the LDAP server and retrieved as needed to authenticate the user.

- **password authentication (keyboard interactive)**

The LDAP server can be used for user authentication using keyboard interactive, as with simple username and password authentication.

2.1.1.4.1 LDAP authentication process

A client starts an LDAP session by connecting to an LDAP server, called a Directory System Agent (DSA), which—by default—are on TCP port 389 and UDP port 636 for LDAP. The SR OS then sends an operation request to the server, and the server sends responses in return, as shown in [Figure 3: LDAP server and SR OS interaction for retrieving the public key](#). With some exceptions, the client does not need to wait for a response before sending the next request, and the server may send the responses in any order. All information is transmitted using Basic Encoding Rules (BER).

In the SR OS, the client can request the following operations:

- **StartTLS**

Uses the LDAPv3 Transport Layer Security (TLS) extension for a secure connection.

- **Bind**

Authenticates and specifies the LDAP protocol version.

- **Search**

Searches for and retrieves directory entries.

- **Unbind**

Closes the connection (not the inverse of Bind).

Figure 3: LDAP server and SR OS interaction for retrieving the public key

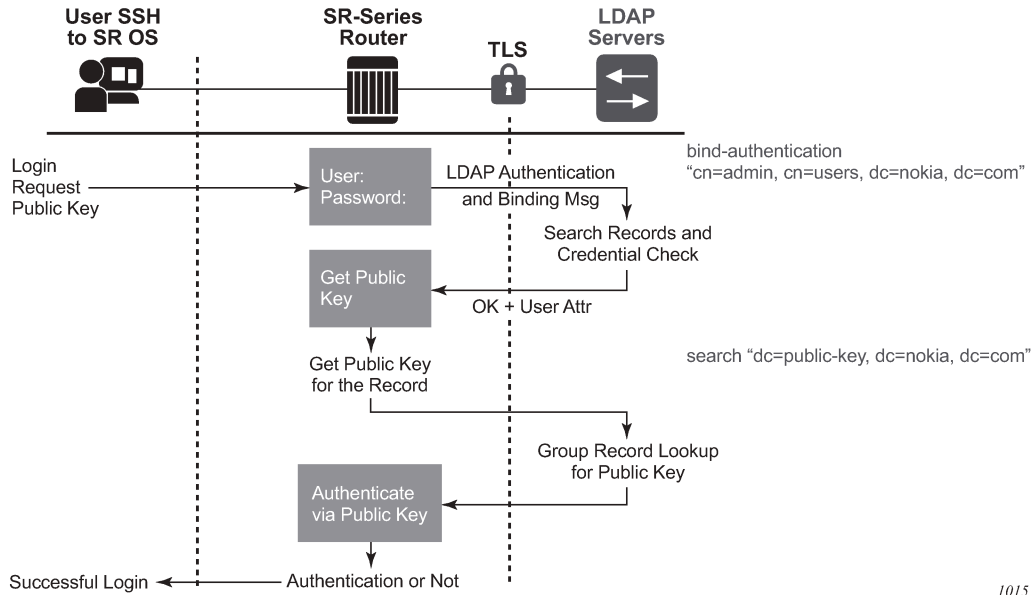

The connection between the router as the LDAP client and the LDAP server should be encrypted using TLS, as all credentials between the router and LDAP are transmitted in clear text.

2.1.1.4.2 Authentication order

SR OS supports local and LDAP public key storage, the order of which is configurable. Use the following command to configure authentication order:

- **MD-CLI**

```
configure system security user-params authentication-order
```

- **classic CLI**

```
configure system security password authentication-order
```

The SR OS sends available authentication methods to the client and supports public key and password authentication. Use the following command to configure the client to use the public key authentication method:

- **MD-CLI**

```
configure system security aaa remote-servers ldap public-key-authentication
```

- **classic CLI**

```
configure system security ldap public-key-authentication
```

If the client chooses the public key and LDAP is first in authentication order, the SR OS tries to authenticate using public key retrieval from the LDAP server. If the public key retrieval from LDAP server

fails and **exit-on-reject** is not configured, the SR OS tries the next method (**local**) in the authentication order for the public key. If the next method also fails, a user authentication fail message is sent to the client.

If the public key retrieval from the LDAP server fails and **exit-on-reject** is configured, the SR OS does not try the next method in the authentication order. A user-authentication fail message is sent to the client. At this point, the client can be configured to only use public key authentication or use both public key authentication followed by password authentication. If the client is configured to use password authentication, it goes through the authentication order again (for example, it tries all the configured methods in the configured authentication order) as long as **exit-on-reject** is not configured.

2.1.1.4.2.1 Authentication order public key detail

There are two keys for public key authentication: a private key stored on the client and a public key stored on the server (local) or AAA server (LDAP). The client uses the private key to create a signature, which only the public key can authenticate. If the signature is authenticated using the public key, then the user is also authenticated and is granted access. SR OS can locally store, using CLI, as many as 32 RSA keys and 32 ECDHA keys for a single user. In total, the SR OS can load a maximum of 128 public keys in a single authentication attempt.



Note: The client creates a signature using a single private key, but this signature can be authenticated on the SR OS with maximum of 128 public keys in a single try. If all these public keys fail to authenticate, then a failure message is sent to the client and the number of failed attempts is incremented.

If the client has another private key, it can create a new signature with this new private key and attempt the authentication one more time, or switch to password authentication.

The following steps describe the procedure where the client attempts to authenticate using a public key and the authentication order is configured as **ldap**, then **local**.



Note: With each increment of failed attempts, the SR OS also checks the limit for lock-out. If the limit is reached, the user is locked out.

1. The SSH client opens a session and tries to authenticate the user with private-key-1 (creating signature-1 from private-key-1).
2. The SR OS checks the authentication order.
3. The SR OS loads public keys for the user, as follows.
 - a. If **exit-on-reject** is not configured, the SR OS loads all public keys from the LDAP server and all public keys from the locally-saved location.
 - b. If **exit-on-reject** is configured, the SR OS only loads all public keys from the LDAP server and not from the locally-saved location.
4. The SR OS compares received client signature-1 with signature calculated from loaded public keys and attempts to find a match.
 - a. If a match is found, the user is authenticated. The procedure ends.
 - b. If no match is found, authentication fails and the SSH client is informed. The LDAP server waits for the SSH client's reaction.
5. The SSH client reacts in one of several ways.
 - a. The connection is closed.

- b. The password authentication method is continued. In this case, on the SR OS, the number of failed authentication attempts is not incremented.
- c. The next public key is continued, as follows.
 - i. If it is not 21st received public key, return to step 3.
 - ii. If it is the 21st received public key, the number of failed authentication attempts is incremented and the connection is closed.

2.1.1.4.3 LDAP authentication using a password

In addition to public key authentication, the SR OS supports password (keyboard) authentication using the LDAP server.



Note: TLS provides the encryption for password authentication.

In the following example, the client attempts to authenticate using a password and only LDAP is configured in the authentication order.

1. The client uses Telnet or SSH to reach the SR OS.
2. The SR OS retrieves the username and password (in plain text).
3. The SR OS performs a bind operation to the LDAP server. Use the following command to set the root DN and password:

- **MD-CLI**

```
configure system security aaa remote-servers ldap server bind-authentication password
configure system security aaa remote-servers ldap server bind-authentication root-dn
```

- **classic CLI**

```
configure system security ldap server bind-authentication password password root-dn
```

4. The SR OS performs a search operation for the username on LDAP server.
 - a. If the username is found, LDAP sends `user_distinguished_name` to the router.
 - b. If the username is not found, the authentication fails. The attempt and failed attempt counters are incremented.
5. The SR OS performs a bind operation to LDAP with `user_distinguished_name` and the password from step 2.
6. The LDAP server checks the password.
 - a. If the password is correct, the bind operation succeeds. The failed attempt and successful attempt counters are incremented.
 - b. If the password is incorrect, bind is unsuccessful and authentication fails. The attempt and failed attempt counters are incremented.
7. The SR OS sends a message to unbind from the LDAP server.

2.1.1.4.4 Timeout and retry configuration for the LDAP server

Use the following commands to configure the number of retry attempts and the response timeout for the LDAP server:

- **MD-CLI**

```
configure system security aaa remote-servers ldap server-retry
configure system security aaa remote-servers ldap server-timeout
```

- **classic CLI**

```
configure system security ldap retry
configure system security ldap timeout
```

The server retry value is the maximum number of connection attempts that the SR OS can make to reach the current LDAP server before attempting the next server. For example, if the value is set to the default of 3, the SR OS tries to establish the connection to current server three times before attempting to establish a connection to the next server.

The server timeout value is the number of seconds that the SR OS waits for a response from the server with which it is attempting to establish a connection. If the server does not reply within the specified timeout value, the SR OS increments the retry counter by one. The SR OS attempts to establish the connection to the current server up to the configured retry value before moving to the next configured server.

2.1.1.4.5 TLS behavior and LDAP

RFC 4511 section 4.14.1 states, "A client requests TLS establishment by transmitting a StartTLS request message to the server" and "The client MUST NOT send any LDAP PDUs at this LDAP message layer following this request until it receives a StartTLS Extended response". As such, if an LDAP has a TLS profile configured and the TLS is in an operationally down state, no LDAP packets are transmitted if TLS negotiation has not been completed, including when the TLS profile is shut down.

2.1.1.4.6 LDAP health check

The LDAP health-check function is available for operator management purposes and can be disabled. The SR OS health check attempts to establish a TCP connection to the LDAP server and polls the server at a specified interval (the default is 30 seconds). The TCP connection is closed by an LDAP unbind message.

Use the following command to configure the health check for LDAP:

- **MD-CLI**

```
configure system security aaa health-check
```

- **classic CLI**

```
configure system security password health-check
```

2.1.1.4.7 LDAP redundancy and TLS

LDAP supports up to five redundant (backup) servers. Depending on the configuration of **timeout** and **retry** values, if an LDAP server is found to be out of service or operationally down, the SR OS will switch to the redundant servers. The SR OS will try the next LDAP server in the server list by choosing the next largest configured server index.

LDAP servers can use the same TLS profile or can have their own TLS profile. Each TLS profile can have a different configuration of **trust-anchor**, **cipher-list** and **cert-profile**. For security reasons, the LDAP server could be in different geographical areas and, therefore, each will be assigned its own server certificate and trust anchor. The TLS profile design allows users to mix and match all components.

Redundant LDAP servers are shown in [Figure 4: LDAP and TLS redundancy](#).

Figure 4: LDAP and TLS redundancy

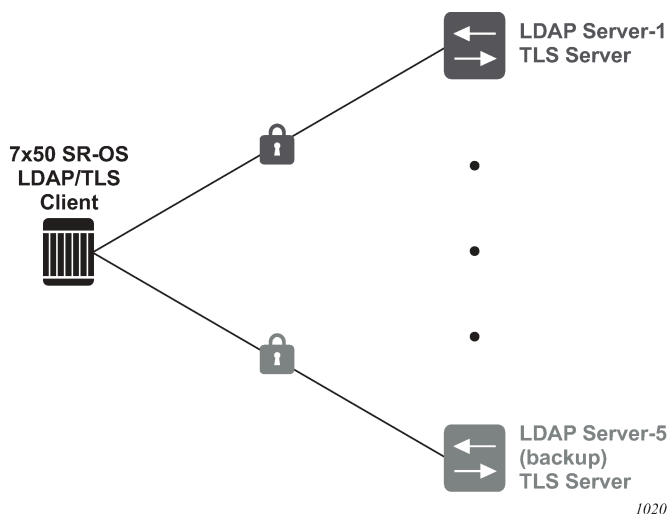

2.1.1.5 Password hashing

SR OS supports multiple algorithms for user password hashing, including bcrypt and PBKDF2. The PBKDF2 algorithm can use SHA2 (SHA-256) or SHA3 (SHA-512) for hashing.

Use the following command to configure the algorithm to hash all user passwords:

- **MD-CLI**

```
configure system security user-params local-user password hashing
```

- **classic CLI**

```
configure system security password hashing
```

When password hashing is configured, the following sequence of steps occurs at login:

1. The node checks the stored password and notes its hash algorithm.
2. The password entered by the user is hashed with the noted algorithm, and the node compares the hash with the stored user password hash.

3. If the entered and the stored passwords are the same, and if the hash algorithm of the stored user password is different than the hash algorithm of the system password, the user is prompted to enter a new password 2 times to ensure password match. The node stores this new password in the RAM (not in the system configuration file).

To store the new password in the configuration file, an admin user must perform an **admin save** command. If the **admin save** command is not executed, then on the next reboot the hash algorithm of the stored user password may be different than the system hash and the user must go through this process again from step 2.

After an upgrade to a software load that supports PBKDF2, the default password continues to be stored using the bcrypt algorithm. The following example describes the procedure to change the algorithm. In the example, the algorithm is changed to PBKDF2 and "user X" can be any user.

1. User X logs in and runs the **hashing** command to change the algorithm.
2. To save the algorithm change, an admin user performs an **admin save** command.
3. To store user X's password using PBKDF2, the admin user changes user X's password.
4. From this point onward, any new user passwords or changes to existing user passwords are stored using PBKDF2.

2.1.2 Authorization

The SR OS supports local, RADIUS, and TACACS+ authorization to control the actions of specific users. The following authorization methods can be configured to control actions of specific users:

- [Local authorization](#)
- [RADIUS authorization](#)
- [TACACS+ authorization](#)

Local authorization and RADIUS authorization operate by applying a command authorization profile that is associated with the user.

For RADIUS authorization, the profiles are configured locally on the router or downloaded using VSAs from a RADIUS server. See [RADIUS VSAs](#).

For TACACS+ authorization, local profiles configured on the router can be used or remote profiles configured on the TACACS+ server can be used whereby each command is sent to the TACACS+ server for authorization.

Authorization applies to CLI access as well as NETCONF or gRPC access. See [Authorization profiles for classic and model-driven management interfaces](#) for more details.

2.1.2.1 Local authorization

Local authorization uses user profiles and user access information after a user is authenticated. The profiles and user access information specifies the actions the user is allowed to perform.

For more information, see [Configuring local command authorization profiles](#).

2.1.2.2 RADIUS authorization

RADIUS authorization grants or denies access permissions for a user. Permissions include the use of FTP, Telnet, SSH (SCP and SFTP), and console access. When granting Telnet, SSH (SCP and SFTP), and console access to the router, authorization can be used to limit user access to the CLI commands and files.

When a user has been authenticated using RADIUS (or another method), the router can be configured to perform authorization. The RADIUS server can be used to:

- download the user command authorization profile to the router
- send the profile name that the router should apply to the user (these profiles must be created on each router)

If RADIUS authentication is successful and no authorization is configured for the user on the RADIUS server, local (router) authorization is attempted, if configured using the **authentication-order** command.

When authorization is configured and profiles are downloaded to the router from the RADIUS server, the profiles are considered temporary configurations and are not saved when the user session terminates.

The temporary profiles are only downloaded if the user authenticates via RADIUS. RADIUS-based authorization is not supported for users who authenticate locally or via TACACS+.

The following table lists the supported authorization configurations.

Table 2: Supported authorization configurations

| | Local | RADIUS supplied profile |
|--------------------------------|-------|-------------------------|
| Locally configured user | ✓ | |
| RADIUS server configured user | ✓ | ✓ |
| TACACS+ server configured user | ✓ | |

When using authorization, maintaining a user database on the router is not required. Usernames can be configured on the RADIUS server. Usernames are temporary and are not saved in the configuration when the user session terminates. Temporary user login names and their associated passwords are not saved as part of the configuration.

2.1.2.3 TACACS+ authorization

TACACS+ command authorization operates in the following ways:

- All users who authenticate via TACACS+ can use a single common command authorization profile that is configured locally on the router.
- All commands users attempt are sent to the TACACS+ server for authorization.
- Local **tacplus priv-lvl-map** configuration maps the privilege level provided by the TACACS+ server to locally configured command authorization profiles (when the **use-priv-lvl** command is enabled).
- The TACACS+ default template and Vendor-Specific Attributes (VSAs) control file access. Enable the **use-default-template** command to configure all other access controls locally. Optionally configure the **use-priv-lvl** command for command authorization.

To use a single common default command authorization profile to control command authorization for TACACS+ users, enable the TACACS+ default user template and configure the template to point to a valid

local profile. The local profile is then used for command authorization. TACACS+ authorization must be disabled.

Use the following commands to configure a single common local command profile called "default" for command authorization for all TACACS+ users:

- **MD-CLI**

```
configure system security aaa remote-servers tacplus use-default-template
configure system security aaa user-template user-template-name tacplus-default profile
"default"
delete configure system security aaa remote-servers tacplus authorization
```

- **classic CLI**

```
configure system security tacplus use-default-template
configure system security user-template tacplus_default profile "default"
configure system security tacplus no authorization
```

When the **tacplus authorization** command is enabled without the **use-priv-lvl** command, each CLI command the user issues is sent to the TACACS+ server for authorization. The authorization request that SR OS sends contains the first word of the CLI command as the value for the TACACS+ cmd and all the following words as a cmd-arg. Quoted values are expanded so that the quotation marks are stripped off and the enclosed values are seen as one cmd or cmd-arg.

When the **authorization use-priv-lvl** command is configured, the router maps the privilege level returned by the TACACS+ server to a local profile as configured under the **priv-lvl-map** command. Command authorization then uses the local profile. If the TACACS+ server does not return a privilege level, and the **tacplus use-default-template** command is enabled, the router uses the local profile configured in the **user-template** for command authorization.

2.1.2.3.1 TACACS+ authorization examples

For TACACS+ authorization, the SR OS sends the entire CLI context in the cmd and cmd-arg and values.

Example: Commands typed in the CLI

```
show
show port
show port 1/1/1
show port 1/1/1 detail
```

Example: AV pairs resulting from commands typed in the CLI

The commands typed in the previous example result in the following AV pairs.

```
cmd=show

cmd=show
cmd-arg=port

cmd=show
cmd-arg=port
cmd-arg=1/1/1

cmd=show
cmd-arg=port
cmd-arg=1/1/1
```

```
cmd-arg=detail
```

2.1.2.3.2 TACACS+ based configuration command authorization in model-driven interfaces

Configuration command authorization using TACACS+ sends multiple requests that may be the same depending on the configuration changes. In model-driven interfaces, command authorization is required for the following changes to the candidate configuration:

- the command that was entered; for example, **system name node-2**
- the resulting configuration changes, because other elements may be modified or deleted; for example, **delete router "Base"** deletes the entire Base router configuration, and all of the deletions must be authorized



Note: If the command authorization fails, the resulting configuration changes are not authorized.

Multiple authorization requests are also sent in the following cases:

- for MD-CLI compound commands where multiple elements are changed in one command, as shown in the following examples.

```
system name node-2 location NYC
system name node-2 } router router-id 10.1.1.1
```

- configuration changed by an element's YANG modeling constraints, such as "choice" or "when" statements

The following example shows how setting the system name is an operation that changes one configuration element.

Example

```
[ex:/configure]
A:admin@node-2# system name foo

# Command authorization
cmd=configure
cmd-arg=system
cmd-arg=name
# Resulting change authorization
cmd=configure
cmd-arg=system
cmd-arg=name
```

The following log example shows that the **memory** context and the **console** command are mutually exclusive, and configuring a new value deletes the existing value. The system must also authorize the deletion.



Note: Command accounting only logs the command that is entered.

Example: Existing configuration

```
[ex:/configure log log-id "42" destination]
A:admin@node-2# info
memory {
```

```
}

```

Example: Configuration commands

```
[ex:/configure log log-id "42" destination]
A:admin@node-2# console
```

Example: Resulting configuration

```
[ex:/configure log log-id "42" destination]
A:admin@node-2# info
console
```

Example: Command authorization requests

```
# Command authorization
cmd=configure
cmd-arg=log
cmd-arg=log-id
cmd-arg=42
cmd-arg=destination
cmd-arg=console
# Resulting change authorization for console
cmd=configure
cmd-arg=log
cmd-arg=log-id
cmd-arg=42
cmd-arg=destination
cmd-arg=console
# Resulting change authorization for memory
cmd=configure
cmd-arg=log
cmd-arg=log-id
cmd-arg=42
cmd-arg=destination
cmd-arg=memory
```

2.1.2.3.3 TACACS+ based authorization of delete operations in model-driven interfaces

Use either of the following commands in model-driven interfaces, to configure the system to use TACACS+ authorization requests to send the delete operation in the cmd argument and the path in the cmd-arg argument. These commands configure TACACS+ to allow modification and deletion. All deletions use the same TACACS+ cmd=delete request format.

```
configure system security aaa remote-servers tacplus authorization request-format delete
configure service vprn aaa remote-servers tacplus authorization request-format delete
```



Note: The delete operation can be used anywhere in MD-CLI input, for example:

```
delete configure system name
configure delete system name
configure system delete name
```

The following example shows the AV pairs that are sent.

Example

```
[ex:/configure system]
A:admin@node2# delete name

# Command authorization
cmd=delete
cmd-arg=configure
cmd-arg=system
cmd-arg=name
# Resulting change authorization
cmd=delete
cmd-arg=configure
cmd-arg=system
cmd-arg=name
```

2.1.2.4 Authorization profiles for classic and model-driven management interfaces

Authorization profiles can be configured to match commands in either classic CLI or MD-CLI format. Depending on the configuration, a match may succeed. Each entry in a profile can be formatted for the classic CLI or the MD-CLI.



Note: Nokia recommends creating separate profiles for each management interface type.

Authorization checks are not performed by default for telemetry data. All configuration and state elements are available to authenticated telemetry subscriptions, with the exception of LI (Lawful Intercept) configuration and state elements, which are authorized separately based on the LI authorization configuration. Use the following command to control telemetry data authorization:

- **MD-CLI**

```
configure system security aaa management-interface output-authorization telemetry-data
```

- **classic CLI**

```
configure system security management-interface output-authorization telemetry-data
```

[Table 3: Authorization and match hit based on entry format](#) shows authorization and match hit based on the entry format configuration. This is true whether authorization is done using local user profiles or using an AAA server like TACACS+ or RADIUS.

Table 3: Authorization and match hit based on entry format

| Profile entry format | Classic CLI | MD-CLI | NETCONF | gNMI set and get (gRPC) |
|----------------------|-------------|--------|---------|-------------------------|
| Classic CLI | Yes | Maybe | Maybe | Maybe |
| MD-CLI | Maybe | Yes | Yes | Yes |

2.1.2.5 Authorization support

Table 4: Authorization support lists the authorization support using a local profile or an AAA server.

Table 4: Authorization support

| | Classic CLI | MD-CLI | NETCONF | gNMI set and get (gRPC) |
|---------|-------------|--------|---------|-------------------------|
| LDAP | — | — | — | — |
| TACACS+ | Yes | Yes | Yes | Yes |
| RADIUS | Yes | Yes | Yes | Yes |
| Local | Yes | Yes | Yes | Yes |

2.1.2.5.1 System-provisioned AAA command authorization profiles

SR OS provides the following built-in (system-provisioned) AAA command authorization profiles, these profiles can be removed or modified:

- default
- administrative

The built-in profiles are applicable to users using the classic CLI or the MD-CLI, and contain rules that apply to classic CLI and rules that apply to MD-CLI interfaces in the same profile.

By default, in SR OS, the administrative profile is associated with the built-in user called 'admin'.

In the classic CLI, the default profile is automatically assigned to any newly-created user, but the user can remove the profile from any user and replace it with another profile. The classic CLI also has an internal mechanism that denies access to **show system security** commands for all users, so users must be given access to these commands with a permit entry in a profile.

In the MD-CLI, a newly-created user is not associated with any profile. The operator can manually associate a user with the default profile if required.

2.1.2.5.2 Configuring authorization support for configuration groups



Note: This information applies to the MD-CLI.

To configure authorization for configuration groups explicitly, create an entry for the group configuration in the user's profile.

For example, to deny access to router interfaces in both the main configuration branch and in the group configuration branch, create an entry for each one.

In the following example, entry 10 prevents the user from viewing, creating, and editing router interfaces in the main configuration branch and from inheriting router interface configurations from configuration groups. Entry 20 prevents the user from viewing, creating, and editing router interfaces in the group configuration branch.

Example

```
[ex:/configure system security aaa local-profiles profile "exampleProfile"]
A:admin@node-2# info
  entry 10 {
    match "configure router interface"
    action deny
  }
  entry 20 {
    match "configure groups group router interface"
    action deny
  }
```

2.1.3 Accounting

2.1.3.1 RADIUS accounting

Accounting can be configured independently from RADIUS authorization and RADIUS authentication.

When enabled, RADIUS accounting sends command line accounting from the router to the RADIUS server on UDP port 1813 or TCP port 2083 with TLS. The server receives accounting requests and returns a response to the router indicating that it has successfully received the request. Each command issued on the router generates a record sent to the RADIUS server. The record identifies the user who issued the command and the timestamp. If no response is received in the time defined in the timeout parameter, the accounting request must be retransmitted until the configured retry count is exhausted. A trap is issued to alert the NMS (or trap receiver) that the server is unresponsive. The router issues the accounting request to the next configured RADIUS server (up to 5).

User passwords and authentication keys of any type are never transmitted as part of the accounting request.

2.1.3.2 TACACS+ accounting

The SR OS allows the administrator to configure the type of accounting record packet that is to be sent to the TACACS+ server when specified events occur on the device. The **accounting record-type** parameter indicates whether TACACS+ accounting start and stop packets be sent or just stop packets be sent. Start/stop messages are only sent for individual commands, not for the session.

When a user logs in to request access to the network using Telnet or SSH, or a user enters a command for which accounting parameters are configured, or a system event occurs, such as a reboot or a configuration file reload, the router checks the configuration to see if TACACS+ accounting is required for the particular event.

If TACACS+ accounting is required, then, depending on the accounting record type specified, sends a start packet to the TACACS+ accounting server which contains information about the event.

The TACACS+ accounting server acknowledges the start packet and records information about the event. When the event ends, the device sends a stop packet. The stop packet is acknowledged by the TACACS+ accounting server.

2.1.3.3 Command accounting log events

In addition to RADIUS and TACACS+ accounting, SR OS supports a set of log events dedicated to command accounting.

For the following log events related to command accounting, see the *SR OS Log Events Guide*:

- cli_user_io
- snmp_user_set
- cli_config_io
- cli_unauth_user_io
- cli_unauth_config_io
- md_cli_io
- md_cli_unauth_io
- netconf_auth
- netconf_unauth
- grpc_auth
- grpc_unauth

2.1.4 Security controls

Configure routers to use RADIUS, TACACS+, LDAP, and local AAA methods to validate users requesting access to the network. The order in which requests are processed among RADIUS, TACACS+, LDAP, and local can be specifically configured. In other words, the authentication order can be configured to process authorization through TACACS+ first, then RADIUS for authentication and accounting. Local access can be specified next in the authentication order if the RADIUS and TACACS+ servers are not operational. The security methods capabilities are listed in [Table 5: Security methods capabilities](#).

Table 5: Security methods capabilities

| Method | Authentication | Authorization | Accounting |
|---------|----------------|---------------|----------------|
| Local | ✓ | ✓ | ✓ ¹ |
| TACACS+ | ✓ | ✓ | ✓ ¹ |
| RADIUS | ✓ | ✓ | ✓ ¹ |
| LDAP | ✓ | Not supported | Not supported |

¹ CLI commands are always logged in local command accounting log events such as cli_user_io or md_cli_io.

2.1.4.1 When a server does not respond

A trap is issued if a RADIUS server is unresponsive. An alarm is raised if RADIUS is enabled with at least one RADIUS server and no response is received to either accounting or user access requests from any server.

Periodic checks to determine if the primary server is responsive again are not performed. If a server is down, it is not contacted for 5 minutes. If a login is attempted after 5 minutes, then the server is contacted again. When a server does not respond with the health check feature enabled, the server's status is checked every 30 seconds. Health check is enabled by default. When a service response is restored from at least one server, the alarm condition is cleared. Alarms are raised and cleared on Nokia's Fault Manager or other third-party fault management servers.

The servers are accessed in order from lowest to highest specified index (from 1 to 5) for authentication requests until a response from a server is received. A higher indexed server is only queried if no response is received, implying a lower indexed server is not available. If a response from the server is received, no other server is queried.

2.1.4.2 Authentication and authorization request flow

Use the following command to control the authentication and authorization order shown in [Figure 5: Security flow](#):

- **MD-CLI**

```
configure system security user-params authentication-order
```

- **classic CLI**

```
configure system security password authentication-order
```

The order is determined by specifying the sequence in which an authentication or authorization method is attempted when the **exit-on-reject** command option is disabled.

Example: Authentication and authorization method flow

[Figure 5: Security flow](#) shows an example that uses the order of RADIUS, then TACACS+, and finally, local. A request is sent to RADIUS server 1. If there is no response from the server, the request is sent to the next RADIUS server and so on, until the last RADIUS server is attempted (RADIUS server 5). If server 5 does not respond, the request is sent to TACACS+ server 1. If there is no response from that server, the request is sent to the next TACACS+ server, and so on.

If a request is sent to an active RADIUS server and the username and password is not recognized, access is denied and the next method is attempted, in this case, the TACACS+ server. The process continues until the request is either permitted, denied, or each server is queried. Finally, if the request is denied by the active TACACS+ server, the local method is attempted. This is the last chance for the access request to be permitted.

Figure 5: Security flow

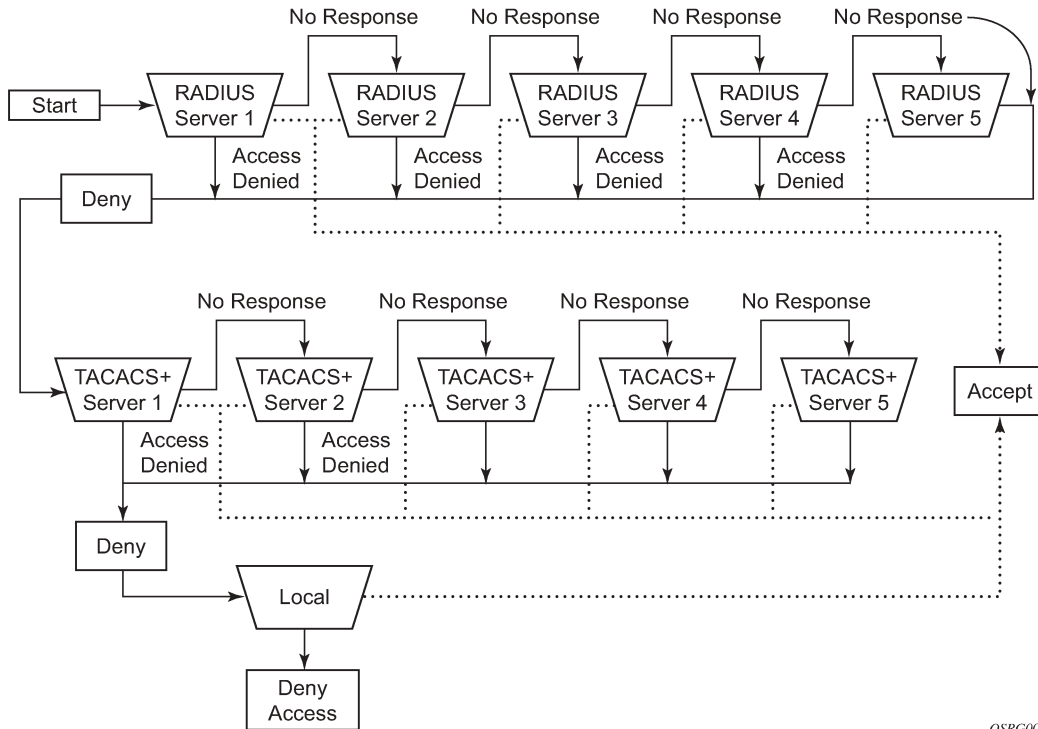

OSRG009

2.2 RADIUS VSAs

The software supports the configuration of Nokia-specific RADIUS attributes. These attributes are known as VSAs and are defined in RFC 2138. The RADIUS user authenticates with parameters defined in the default RADIUS user template if VSAs are not configured in the RADIUS server. If VSAs are configured, all mandatory VSAs must be configured for the RADIUS user to authenticate. It is up to the vendor to specify the format of their VSA. The attribute-specific field is dependent on the vendor's definition of that attribute. The Nokia-defined attributes are encapsulated in a RADIUS vendor-specific attribute with the vendor ID field set to 6527, the vendor ID number. Nokia VSAs are defined in the dictionary-freeradius.txt file in the support folder of the software distribution.

The following RADIUS VSAs for AAA are supported:

- **Timetra-Access** <ftp | console | both | netconf | grpc>

This is a mandatory VSA that specifies if the user has FTP, console (console port, Telnet, and SSH), both (FTP and console), NETCONF, or gRPC access. Multiple access values can be specified in any order separated by hyphens (-) in the RADIUS server configuration file, for example.

```
Timetra-Access = grpc-netconf-console-ftp
```

- **Timetra-Profile** <string>

This VSA is mapped to the user profiles which must be configured on the router. The following guidelines apply to local and remote authentication:

1. The **authentication-order** parameter configured on the router must include the **local** keyword.
2. The username may or may not be configured on the router.
3. The user must be authenticated by the RADIUS server.
4. Up to 8 valid profiles can exist on the router for a user. The sequence in which the profiles are specified is relevant. The most explicit matching criteria must be ordered first. The process stops when the first complete match is found.

If all the above mentioned conditions are not met, then access to the router is denied and a failed login event/trap is written to the security log.

- **Timetra-Action <permit | deny>**

This VSA specifies the action when the user has entered a command specified in the Timetra-Cmd VSA.

- **Timetra-Default-Action <permit-all | deny-all | read-only-all | none>**

This is a mandatory VSA that must be configured even if the Timetra-Cmd VSA is not used. This VSA specifies the default action when the user has entered a command, and no entry configured in the Timetra-Cmd VSA for the user has matched.

- **Timetra-Cmd <string>**

This VSA configures a command or command subtree as the scope for the match condition. The command and all commands in subtrees are authorized. If an invalid command is specified, a deny-all profile is installed and the radiusUserProfileInvalid event is logged.

- **Timetra-Home-Directory <string>**

This VSA specifies a user's home directory. It cannot be used to delete a home directory that is configured in the RADIUS default template.

- **Timetra-Restrict-To-Home <true | false>**

When this VSA is set to true, the user's file system access is restricted to the home directory specified with Timetra-Home-Directory.

- **Timetra-Save-When-Restricted <true | false>**

When this VSA is set to true, the user can execute configuration save operations (for example, **admin save**) via any management interface (CLI, NETCONF, and so on) when Timetra-Restrict-To-Home is set to true.

- **Timetra-Exec-File <string>**

This VSA specifies a user's login exec file which executes whenever the user successfully logs in to a console session.

- **Timetra-NETCONF-BaseOp <cancel-commit | close-session | commit | copy-config | create-subscription | delete-config | discard-changes | edit-config | get | get-config | get-data | get-schema | kill-session | lock | validate>**

This VSA specifies the NETCONF operations that the user can execute. Multiple operation values can be specified in any order separated by semicolons (;) in the RADIUS server configuration file, for example.

```
Timetra-NETCONF-BaseOp = close-session;commit;discard-changes;edit-config;get-config;lock;validate
```

Multiple RPCs can also be specified on different lines in the RADIUS server configuration file, for example.

```
Timetra-NETCONF-BaseOp = close-session,
Timetra-NETCONF-BaseOp = commit,
Timetra-NETCONF-BaseOp = discard-changes,
Timetra-NETCONF-BaseOp = edit-config,
Timetra-NETCONF-BaseOp = get-config,
Timetra-NETCONF-BaseOp = lock,
Timetra-NETCONF-BaseOp = validate
```

If an invalid operation is specified, a deny-all profile is installed and the radiusUserProfileInvalid event is logged.

- **Timetra-NETCONF-Default-Action <permit | deny>**

This is a mandatory VSA that must be configured when the Timetra-NETCONF-BaseOp VSA is used. This VSA specifies the default action when the user has executed an operation, and no operation configured in the Timetra-NETCONF-BaseOp VSA for the user has matched.

- **Timetra-gRPC-RPC <gnmi-capabilities | gnmi-get | gnmi-set | gnmi-subscribe | gnoi-cert-mgmt-cangenerate | gnoi-cert-mgmt-getcert | gnoi-cert-mgmt-install | gnoi-cert-mgmt-revoke | gnoi-cert-mgmt-rotate | gnoi-file-get | gnoi-file-put | gnoi-file-remove | gnoi-file-stat | gnoi-file-transfertoremove | gnoi-system-cancelreboot | gnoi-system-ping | gnoi-system-reboot | gnoi-system-rebootstatus | gnoi-system-setpackage | gnoi-system-switchcontrolprocessor | gnoi-system-time | gnoi-system-traceroute | md-cli-session | rib-api-getversion | rib-api-modify>**

This VSA specifies the gRPC RPCs the user can execute. Multiple RPCs can be specified in any order separated by semicolons (;) in the RADIUS server configuration file, for example.

```
Timetra-gRPC-RPC = gnmi-capabilities;gnmi-subscribe
```

Multiple RPCs can also be specified on different lines in the RADIUS server configuration file, for example.

```
Timetra-gRPC-RPC = gnmi-capabilities,
Timetra-gRPC-RPC = gnmi-subscribe
```

If an invalid RPC is specified, a deny-all profile is installed and the radiusUserProfileInvalid event is logged.

- **Timetra-gRPC-Default-Action <permit | deny>**

This is a mandatory VSA that must be configured when the Timetra-gRPC-RPC VSA is used. This VSA specifies the default action when the user has executed an RPC, and no RPC configured in the Timetra-gRPC-RPC VSA for the user has matched.

2.2.1 RADIUS configuration for file access control using VSAs

Configure file access control in one of the following ways depending on the file access requirements of users:

- locally with no VSAs
- with VSAs



Note: File access is denied when the **restricted-to-home** command is configured, unless the **home-directory** command is configured and the directory is created by an administrator.

Example: RADIUS server with VSA configuration and per-user home directories

This example shows the following configuration:

- All file access controls are configured with VSAs, which is the most flexible option to grant different file access to each user.
- The RADIUS default template is not used for file access.
- Each user has a home directory. The administrator must create a home directory for each user.
- The administrator can also restrict file access to the home directory of the user and allow users to save the configuration based on the VSA value.

The user1 profile has access to all files and user1 can save the configuration.

RADIUS server configuration

```
user1
# Timetra-Home-Directory is not defined
Timetra-Restrict-To-Home = false
# Timetra-Save-When-Restricted is not defined
```

The user2 profile has home directory access and user2 can save the configuration.

RADIUS server configuration

```
user2
Timetra-Home-Directory = "cf3:\users\user2",
Timetra-Restrict-To-Home = true,
Timetra-Save-When-Restricted = true
```

The user3 profile has home directory access but user3 cannot save the configuration.

RADIUS server configuration

```
user3
Timetra-Home-Directory = "cf3:\users\user3",
Timetra-Restrict-To-Home = true,
Timetra-Save-When-Restricted = false
```

The user4 profile has no file access and user4 cannot save the configuration.

RADIUS server configuration

```
user4
# Timetra-Home-Directory is not defined
Timetra-Restrict-To-Home = true,
Timetra-Save-When-Restricted = false
```

2.3 TACACS+ services and VSAs

SR OS supports the "nokia-user" service with several VSAs. Administrators can optionally configure the service and VSAs for each user on a TACACS+ server instead of configuring access controls locally. [Table 6: TACACS+ VSAs](#) describes the supported TACACS+ VSAs.

When TACACS+ services and VSAs are used, the router:

- requests "nokia-user" service VSAs after authentication whether **tacplus authorization** is enabled or disabled, as this option configures per-command authorization
- uses the values from the TACACS+ default template when a VSA is not present
- discards invalid VSA values and authentication fails
- ignores unknown VSAs and authentication succeeds



Note: Ensure the **use-default-template** command is enabled so that users can control other options in the template that are not available as a VSA.

The following table describes the supported services and VSAs.

Table 6: TACACS+ VSAs

| Service Name | VSA Name | Description | Values |
|--------------|-----------------------------|---|--|
| nokia-user | home-directory | Home directory for the user | A string up to 200 characters |
| nokia-user | restricted-to-home | Restrict file access to the home directory of the user | true – denies the user from accessing files outside their home directory false – permits the user to access all files on the system |
| nokia-user | save-when-restricted | Save configurations when the user is restricted to home | true – allows configuration save operations for all configuration regions, for example, bof, debug, configure, or li via any management interface such as, CLI and NETCONF even if restricted-to-home is enabled false – denies saving the configuration when restricted-to-home is enabled |

2.3.1 TACACS+ configuration for file access control using VSAs

Configure file access control in one of the following ways depending on the file access requirements of users:

- locally with no VSAs

- locally using the TACACS+ default template and some VSAs that are different for each user
- using the file access VSAs to control file access, and the TACACS+ default template for other user access controls



Note: File access is denied when the **restricted-to-home** command is configured unless the **home-directory** command is configured and the directory is created by an administrator.



Note: Some TACACS+ servers require the backslash character (\) to escape the backslash (\) in quoted strings in the server configuration file (`tac_plus.conf`); for example:

- **home-directory = cf3:\users\user1**
- **home-directory = "cf3:\\users\\user1"**

Example: TACACS+ server with VSA configuration for per-user home directories, as well as a locally configured default template for other options

This example shows the following configurations:

- Each user has a home directory with restricted file access. The administrator must create the home directory for each user.
- The home directory is configured with a VSA.
- Other file access controls are configured in the TACACS+ default template.
- All users can save the configuration.

TACACS+ server configuration

```

user = user1 {
  service = nokia-user {
    home-directory = cf3:\users\user1
  }
}

user = user2 {
  service = nokia-user {
    home-directory = cf3:\users\user2
  }
}

user = user3 {
  service = nokia-user {
    home-directory = cf3:\users\user3
  }
}

```

MD-CLI

```

[ex:/configure system security aaa user-template tacplus-default]
A:admin@node-2# info
  restricted-to-home true
  save-when-restricted true

```

Classic CLI

```

A:node-2>config>system>security>user-template# info
-----
  restricted-to-home
  save-when-restricted

```

Example: TACACS+ server with VSA configuration and per-user home directories

This example shows the following configurations:

- All file access is controlled with VSAs, which is the most flexible option to grant different file access to each user.
- The TACACS+ default template is not used for file access.
- Each user has a home directory. The administrator must create a home directory for each user.
- The administrator can also restrict file access to the home directory of the user and allow users to save the configuration based on the VSA value.

The user1 profile has access to all files and user1 can save the configuration.

TACACS+ server configuration

```
user = user1 {
  service = nokia-user {
    # home-directory is not defined
    restricted-to-home = false
    # save-when-restricted is not defined
  }
}
```

The user2 profile has home directory access and user2 can save the configuration.

TACACS+ server configuration

```
user = user2 {
  service = nokia-user {
    home-directory = cf3:\users\user2
    restricted-to-home = true
    save-when-restricted = true
  }
}
```

The user3 profile has home directory access but user3 cannot save the configuration.

TACACS+ server configuration

```
user = user3 {
  service = nokia-user {
    home-directory = cf3:\users\user3
    restricted-to-home = true
    save-when-restricted = false
  }
}
```

The user4 profile has no file access and user4 cannot save the configuration.

TACACS+ server configuration

```
user = user4 {
  service = nokia-user {
    # home-directory is not defined
    restricted-to-home = true
    save-when-restricted = false
  }
}
```

```
}
```

2.4 Control and management traffic protection

SR OS routers support an extensive set of configurable mechanisms to protect the CPU from being flooded with control or management traffic.

These protection mechanisms are a set of configurable hardware-based filters, classification, queuing, and rate-limiting functions that drop unwanted traffic before it reaches the control processor.

- In-band traffic extracted from the line cards to the CPM:
 - Line card features:
 - ACLs filters: IPv4, IPv6, and MAC
 - anti-spoofing, uRPF
 - distributed CPU protection
 - CPM features:
 - CPM Filters: IPv4, IPv6, and MAC
 - centralized CPU Protection
 - per-peer queues, protocol queues, CPM queues
- Out-band and in-band traffic: Management access filters

2.4.1 CPM filters

CPM filters are hardware-based filters used to restrict traffic from the line cards directed to the CPM CPU, such as control and management packets. This filtering is performed by the CPM complex and consumes no resources on the CPM CPU.

Packets from all network and access ports extracted to the CPM CPU are filtered by the CPM filter policy. Packets originating from a management Ethernet port can be filtered using management access filters, see [Management Access Filter](#) for more information.



Note:

- CPM filter is performed by a line card complex using 7750 SR-a, 7750 SR-e, 7750 SR-1, 7750 SR-1s, and 7750 SR-2s.
- CPM filter is not supported on the VSR.

2.4.1.1 CPM filter packet match

Use the commands in the following context to configure the three different CPM filter policies: **ip-filter**, **ipv6-filter**, and **mac-filter**.

```
configure system security cpm-filter
```

The CPM filter packet match rules are listed below.

- Each CPM filter policy is an ordered list of entries. Entries must be sequenced correctly from the most explicit to the least explicit.
- If multiple match criteria are specified in a single CPM filter policy entry, all criteria must be met for the packet to be considered a match against that policy entry (logical AND).
- Any match criteria not explicitly defined is ignored during a match.
- A CPM filter policy entry defined without any match criteria is inactive.
- A CPM filter policy entry with match criteria defined, but no action configured, inherits the default action defined at the **cpm-filter** level.
- The **cpm-filter default-action** applies to IPv4, IPv6, or MAC CPM filters that are in an administratively enabled state.
- When **mac-filter**, **ip-filter**, and **ipv6-filter** are applied to a specific packet, the **mac-filter** is applied first.

2.4.1.2 CPM IPv4 and IPv6 filter entry match criteria

The supported IPv4 and IPv6 match criteria types are shown in the following tables.

[Table 7: Basic Layer 3 match criteria](#) lists the basic Layer 3 match criteria.

Table 7: Basic Layer 3 match criteria

| Criteria | Description |
|----------------|--|
| DSCP | Matches the specified DSCP value against the DSCP/Traffic Class field in the IPv4 or IPv6 packet header. |
| SRC IP, DST IP | Matches the specified source/destination IPv4/IPv6 address prefix/mask against the source/destination IPv4/IPv6 address field in the IP packet header. Optionally, operators can match a list of IP addresses defined in filter match-list ip-prefix-list or match-list ipv6-prefix-list . The prefix-list can be defined statically or using the apply-path command to automatically populate using configured BGP peers defined in the base router or VPRN services. For more details on filter match-list configuration and capabilities, see the <i>7450 ESS, 7750 SR, 7950 XRS, and VSR Router Configuration Guide, "Match list for filter policies"</i> . |
| fragment | For IPv4, match against the MF bit or Fragment Offset field to determine if the packet is a fragment. For IPv6 match against the next-header field or Fragment Extension Header value to determine whether the packet is a fragment. Up to six extension headers are matched against to find the Fragmentation Extension Header. |

[Table 8: IPv4 options match criteria](#) lists the IPv4 options match criteria.

Table 8: IPv4 options match criteria

| Criteria | Description |
|-----------------|--|
| IP option | Matches the specified option value in the first option of the IPv4 packet. Optionally, operators can configure a mask to be used in a match. |
| option-present | Matches the presence of IP options in the IPv4 packet. Padding and EOOB are also considered as IP options. Up to six IP options are matched against. |
| multiple-option | Matches the presence of multiple IP options in the IPv4 packet. |

[Table 9: IPv6 next-header match criteria](#) lists the IPv6 next-header match criteria.

Table 9: IPv6 next-header match criteria

| Criteria | Description |
|------------|---|
| hop-by-hop | Matches for the presence of hop-by-hop options extension header in the IPv6 packet. This match criterion is supported on ingress only. Up to six extension headers are matched against. |

[Table 10: Upper-layer protocol match criteria](#) lists the upper-layer protocol match criteria.

Table 10: Upper-layer protocol match criteria

| Criteria | Description |
|-------------|---|
| next-header | Matches the specified upper-layer protocol (such as TCP or UDP) against the next-header field of the IPv6 packet header. "*" can be used to specify TCP or UDP upper-layer protocol match (logical OR). Next-header matching also allows matching on the presence of a subset of IPv6 extension headers. See the CLI section for information about which extension header match is supported. |
| protocol | Matches the specified protocol against the Protocol field in the IPv4 packet header (for example, TCP, UDP, or IGMP) of the outer IPv4. "*" can be used to specify TCP or UDP upper-layer protocol match (logical OR). |
| ICMP code | Matches the specified value against the Code field of the ICMP/ICMPv6 header of the packet. This match is supported only for entries that also define protocol/next-header match for ICMP/ICMPv6 protocol. |
| ICMP type | Matches the specified value against the Type field of the ICMP or ICMPv6 header of the packet. This match is supported only for entries that also define protocol/next-header match for "ICMP" or "ICMPv6" protocol. |

| Criteria | Description |
|--------------------------|--|
| SRC port, DST port, port | Matches the specified port value (with or without mask), port list, or port range against the Source Port Number/Destination Port Number of the UDP/TCP packet header. An option to match either source or destination port or both (logical OR) using a single filter policy entry is supported by using a directionless port command. Source/destination match is supported only for entries that also define protocol/next-header match for "TCP", "UDP", or "TCP or UDP" protocols. A non-initial fragment does not match an entry with non-zero port criteria specified. |
| TCP flags ack and syn | Matches the presence or absence of the TCP flags in the TCP header of the packet. This match criteria also requires defining the protocol/next-header match as "TCP". |

Table 11: Router instance match criteria lists the router instance match criteria.

Table 11: Router instance match criteria

| Criteria | Description |
|----------|---|
| router | Matches the router instance packets that are ingressing from for this filter entry. |

2.4.1.3 CPM MAC filter entry match criteria

The MAC match criteria are evaluated against the Ethernet header of the Ethernet frame.

Table 12: Router instance match criteria lists the router instance match criteria.

Table 12: Router instance match criteria

| Criteria | Description |
|------------|---|
| frame-type | The filter matches a specific type of frame format. For example, configuring frame-type ethernet_II matches only Ethernet-II frames. |
| SRC mac | Matches the specified source MAC address frames. Optionally, operators can configure a mask to be used in a match. |
| DST mac | Matches the specified destination MAC address frames. Optionally, operators can configure a mask to be used in a match. |
| etype | Matches the specified Ethernet II frames. The Ethernet type field is a two-byte field used to identify the protocol carried by the Ethernet frame. |
| ssap | Matches the specified frames with a source access point on the network node designated in the source field of the packet. Optionally, operators can configure a mask to be used in a match. |

| Criteria | Description |
|------------|---|
| dsap | Matches the specified frames with a destination access point on the network node designated in the destination field of the packet. Optionally, operators can configure a mask to be used in a match. |
| CFM opcode | Matches the specified packet with the specified cfm-opcode . |

2.4.1.4 CPM filter policy action

The two main CPM filter actions allow the option to accept or drop traffic.

Optionally, traffic can be sent to a user-configured hardware queue using a CPM filter. Nokia recommends this primarily for temporary debug or attack investigation activities.

2.4.1.5 CPM filter policy statistics and logging

For more information, see the *7450 ESS*, *7750 SR*, *7950 XRS*, and *VSR Router Configuration Guide*, "Filter policy" and "Filter policy logging".

2.4.1.6 CPM filter: protocols and ports

Nokia recommends using a strict CPM filter policy allowing traffic from trusted IP subnets for protocols and ports actively used in the router and to explicitly drop other traffic.

[Table 13: Protocols and ports](#) identifies which ports are used by which applications in the SR OS. The source port and destination port reflect the CPM filter entry configuration for traffic ingressing the router and sent to the CPM.

Table 13: Protocols and ports

| Src port number | Dst port number | IP protocol | Application | Description | Accessible out of band | Accessible in band |
|-----------------|-----------------|-------------|--------------|---|------------------------|--------------------|
| | 20 | TCP | FTP | FTP server data. Active FTP client. | Yes | Yes |
| | 21 | TCP | FTP | FTP server control | Yes | Yes |
| 20 | | TCP | FTP | FTP client data | Yes | Yes |
| 21 | | TCP | FTP | FTP client control | Yes | Yes |
| | 22 | TCP | SSH, NETCONF | SSH server, NETCONF server | Yes | Yes |
| 22 | | TCP | SSH | SSH client. Responses for initiated TCP sessions. | Yes | Yes |
| | 23 | TCP | Telnet | Telnet server | Yes | Yes |

| Src port number | Dst port number | IP protocol | Application | Description | Accessible out of band | Accessible in band |
|-----------------|-----------------|-------------|-------------|---|------------------------|--------------------|
| 23 | — | TCP | Telnet | Telnet client. Responses for initiated TCP sessions. | Yes | Yes |
| 49 | | TCP | TACACS+ | TACACS+ client. Responses for initiated sessions. | Yes | Yes |
| 53 | | UDP | DNS | DNS client | Yes ² | Yes |
| 67 | 67 | UDP | DHCPv4 | DHCPv4: Relay agent to server, server to relay agent, and relay agent to relay agent | — | Yes |
| 68 | 67 | UDP | DHCPv4 | DHCPv4: client to relay agent/ server | — | Yes |
| 67 | 68 | UDP | DHCPv4 | DHCPv4: relay agent/server to client | — | Yes |
| | 123 | UDP | NTP | NTP server | Yes | Yes |
| 123 | | UDP | NTP | NTP client | Yes | Yes |
| | 161 | UDP | SNMP | SNMP server: SET and GET commands | Yes | Yes |
| | 179 | TCP | BGP | BGP: server terminated TCP sessions | — | Yes |
| 179 | | | BGP | BGP: client responses for initiated TCP session | — | Yes |
| | 319 | UDP | PTP | 1588 PTP event | — | Yes |
| | 320 | UDP | PTP | 1588 PTP general | — | Yes |
| 389 | | TCP | LDAP | LDAP client (non TLS) | Yes | Yes |
| | 520 | UDP | RIP | RIP | — | Yes |
| 546 | 547 | UDP | DHCPv6 | DHCPv6 – client to server/ relay agent | — | Yes |
| 547 | 547 | UDP | DHCPv6 | DHCPv6 – server to relay agent, relay agent to server, and relay agent to relay agent | — | Yes |
| | 639 | UDP | PIM | MSDP: multicast source discovery protocol | — | Yes |

² DNS-based PGW/GGSN resolution for GTP uplink TPSDA subscribers is only supported in either the Base router or VPRN instance.

| Src port number | Dst port number | IP protocol | Application | Description | Accessible out of band | Accessible in band |
|------------------|------------------|-------------|---------------------|--|------------------------|--------------------|
| 636 | | TCP | LDAPS | LDAP client over TLS | — | Yes |
| | 646 | UDP | LDP | LDP Hello adjacency | — | Yes |
| | 646 | TCP | LDP | LDP/T-LDP: terminated TCP sessions | — | Yes |
| 646 | | TCP | LDP | LDP/T-LDP: responses for initiated TCP sessions | — | Yes |
| | 830 | TCP | NETCONF | NETCONF server | Yes | Yes |
| | ANY | UDP | TWAMP | TWAMP test | — | Yes |
| | 862 | TCP | TWAMP | TWAMP control: terminated TCP session | — | Yes |
| | 862, 64364-64373 | UDP | TWAMP | TWAMP Light (Reflector) | — | Yes |
| 862, 64364-64373 | | UDP | TWAMP | Nokia TWAMP Light Initiator. Non Nokia initiator may use the entire range. | — | Yes |
| | 1025 | UDP | MC-LAG-APS-EP-IPsec | Multi Chassis: LAG, APS (Automation Protection Switching), End Point, IPsec (MIMP), AARP | — | Yes |
| | 1491 | TCP | SNMP Streaming | SNMP streaming server | Yes | Yes |
| | 1645 | UDP | RADIUS Proxy | RADIUS proxy authentication | — | Yes |
| | 1646 | UDP | RADIUS Proxy | RADIUS proxy accounting | — | Yes |
| | 1647 | UDP | RADIUS CoA | RADIUS Dynamic Authorization (CoA/DM) | Yes | Yes |
| | 1700 | UDP | RADIUS CoA | RADIUS Dynamic Authorization (CoA/DM) | Yes | Yes |
| | 1701 | UDP | L2TP | L2TP server | — | Yes |
| | 1812 | UDP | RADIUS CoA | RADIUS Dynamic Authorization (CoA/DM) | Yes | Yes |
| 1812 | | UDP | RADIUS | RADIUS authentication | Yes | Yes |

| Src port number | Dst port number | IP protocol | Application | Description | Accessible out of band | Accessible in band |
|-----------------|-----------------|-------------|-------------|---|------------------------|--------------------|
| 1813 | | UDP | RADIUS | RADIUS accounting | Yes | Yes |
| | 2000 | UDP | WPP | Web portal authentication protocol | — | Yes |
| 2083 | | TCP | RADIUS | RADIUS over TLS | Yes | Yes |
| | 2123 | UDP | GTP | GTP control plane | — | Yes |
| 2123 | | UDP | GTP | GTP control plane | — | Yes |
| | 2152 | UDP | GTP | GTP user plane | — | Yes |
| 2152 | | UDP | GTP | GTP user plane | — | Yes |
| | 3232 | UDP | PIM | PIM MDT | — | Yes |
| | 3503 | UDP | OAM | LSP Ping, LSP Trace, VPRN Trace, VPRN Ping | — | Yes |
| 3868 | | UDP | DIAMETER | Diameter | Yes | Yes |
| | 3784 | UDP | BFD | BFD Control 1 hop BFD and BFD over MPLS LSP | — | Yes |
| | 3785 | UDP | BFD | BFD echo Seamless BFD echo mode for controlled return path | — | Yes |
| | 3799 | UDP | RADIUS | RADIUS Dynamic Authorization (CoA/DM) | Yes | Yes |
| | 4189 | TCP | PCEP | Path Computation Element Protocol | Yes | Yes |
| | 4739 | UDP | NAT | NAT debug | — | Yes |
| | 4784 | UDP | BFD | BFD control multi-hop | — | Yes |
| | 4789 | UDP | VXLAN Ping | VXLAN ping request | — | Yes |
| | 4790 | UDP | VXLAN Ping | VXLAN ping response | — | Yes |
| | 5000 | UDP | Mtrace2 | IP Multicast Mtrace2 | — | Yes |
| | 5351 | UDP | NAT | PCP NAT port mapping protocol | — | Yes |
| | 6068 | TCP | ANCP | ANCP – terminated TCP session | — | Yes |
| 6514 | | TCP | Syslog | Syslog over TLS | Yes | Yes |

| Src port number | Dst port number | IP protocol | Application | Description | Accessible out of band | Accessible in band |
|-----------------|-----------------|-------------|---------------|--|------------------------|--------------------|
| | 6635 | UDP | MPLS over UDP | MPLS over UDP OAM | — | Yes |
| | 6653 | TCP | OpenFlow | OpenFlow – terminated TCP sessions | — | Yes |
| | 6784 | UDP | BFD | uBFD | — | Yes |
| | 8805 | UDP | PFCP | Packet and forwarding control protocol – Used to install dynamic forwarding state | — | Yes |
| | 33408-33535 | UDP | OAM | OAM Traceroute | — | Yes |
| | 45067 | TCP | MCS | Multi-chassis synchronization – Terminated TCP Session (mcs, mc-ring, mc-ipsec) | — | Yes |
| 7784 | | UDP | BFD | Seamless BFD routed return path | — | Yes |
| 45067 | | TCP | MCS | Multi-chassis synchronization – Responses for initiated TCP session (mcs, mc-ring, mc-ipsec) | — | Yes |
| | 49151 | UDP | L2TP | L2TP | — | Yes |
| | 57400 | TCP | gRPC | gRPC | Yes | Yes |
| | 64353 | UDP | MPLS DM | MPLS Delay Measurement using UDP return object | — | Yes |
| N/A | N/A | GRE | GRE | GRE | — | Yes |
| N/A | N/A | ICMP | ICMP | ICMP | Yes | Yes |
| N/A | N/A | IGMP | IGMP | IGMP | — | Yes |
| N/A | N/A | OSPF | OSPF | OSPF | — | Yes |
| N/A | N/A | PIM | PIM | PIM | — | Yes |
| N/A | N/A | RSVP | RSVP | RSVP | — | Yes |
| N/A | N/A | VRRP | VRRP, SRRP | VRRP, SRRP | — | Yes |
| pki-server- | any | TCP | PKI | CMPv2 (Certificate Management Protocol v2) | — | Yes |

| Src port number | Dst port number | IP protocol | Application | Description | Accessible out of band | Accessible in band |
|----------------------------|-----------------|-------------|-------------|--|------------------------|--------------------|
| port or 80/8080 | | | | client – Responses for initiated TCP session | | |
| pki-server-port | any | TCP | PKI | OCSP (Online Certificate Status Protocol) client – Responses for initiated TCP session | — | Yes |
| pki-server-port or 80/8080 | any | TCP | PKI | Auto CRL (Certificate Revocation List) update (client) – Responses for initiated TCP session | Yes | Yes |

2.4.2 CPM per-peer queuing

Per-peer queuing provides isolation between peers by allocating hardware queues on a per-peer basis for the following TCP-based protocols: BGP, T-LDP, LDP, MSDP, Telnet, and SSH.

This mechanism guarantees fair and non-blocking access to shared CPU resources across all peers. For example, this ensures that an LDP-based DoS attack from a specific peer is mitigated and compartmentalized and not all CPU resources are dedicated to the overwhelming control traffic sent by that specific peer.

Use the following command to ensure that service levels are not (or are only partially) impacted in case of an attack toward BGP, T-LDP, LDP, MSDP, Telnet, or SSH.

```
configure system security per-peer-queuing
```

Use the following commands to enable SSH and Telnet support for per-peer queuing.

```
configure system login-control ssh ttl-security
configure system login-control telnet ttl-security
```

2.4.3 CPM queues

CPM queues provides the operator with a tool that is primarily useful for debugging or investigations during an attack. When using the CPM queues, the following recommendations should be considered.

- CPM queues can be used for temporary debug or attack investigation activities, in this case packets can be filtered and directed into the queue using the CPM filter.
- CPM queues are not recommended for normal operation where the system default handling and isolation of protocols into protocol queues is already carefully balanced. If additional protection is needed, then the use of the [Centralized CPU protection](#) and [Distributed CPU protection](#) features is recommended.

2.4.4 Centralized CPU protection

SR OS CPU protection is a centralized rate-limiting function that operates on the CPM to limit traffic destined for the CPU. The term "centralized CPU protection" is referred to as "CPU protection" in this guide and in the CLI to differentiate it from "Distributed CPU Protection".

CPU protection provides interface isolation by rate limiting the total amount of traffic extracted to the CPM per port, interface, or SAP in hardware using a combination of limits configurable at the CPU protection system level or as CPU protection policies assigned to access or network interfaces.

The following limits are configurable at the CPU protection system level:

- **link-specific rate**

This applies to the link-specific protocols LACP (Ethernet LAG control) and Ethernet LMI (ELMI). The rate is a per-link limit (each link in the system has LACP/LMI packets limited to this rate).

- **port overall rate**

This applies to all control traffic, the rate is a per-port limit, and each port in the system has control traffic destined for the CPM limited to this rate.

- **protocol protection**

This blocks network control traffic for unconfigured protocols.

The following limits are configurable independently for access or network interfaces using a dedicated CPU protection policy:

- **overall rate**

This applies to all control traffic destined for the CPM (all sources) received on an interface where the policy is applied. This is a per-interface limit. Control traffic received above this rate is discarded.

- **per-source rate**

This is used to limit the control traffic destined for the CPM from each individual source. This per-source rate is only applied when an object (SAP) is configured with a CPU protection policy and also with the optional **mac-monitoring** or **ip-src-monitoring** commands. A source is defined as a *SAP, Source MAC Address* tuple for MAC monitoring and as a *SAP, Source IP Address* tuple for IP source monitoring. Only specific protocols (as configured under **included-protocols** in the CPU protection policy) are limited (per source) when **ip-src-monitoring** is used.

- **out-profile rate**

This applies to all control traffic destined for the CPM (all sources) received on an interface where the policy is applied. This is a per-interface limit. Control traffic received above this rate is marked as discard eligible (such as, out-profile/low-priority/yellow) and is more likely to be discarded if there is contention for CPU resources.

There are two default CPU protection policies for access and network interfaces.

Policy 254:

- This is the default policy that is automatically applied to access interfaces
- Traffic above 6000 pps is discarded
- overall-rate = 6000
- per-source-rate = max
- out-profile-rate = 6000

Policy 255:

- This is the default policy that is automatically applied to network interfaces
- Traffic above 3000 pps is marked as discard eligible, but is not discarded unless there is congestion in the queuing toward the CPU
- overall-rate = max
- per-source-rate = max
- out-profile-rate = 3000

A three-color marking mechanism uses a green, yellow, and red marking function. This allows greater flexibility in how traffic limits are implemented. The **out-profile-rate** command within the CPU protection policy maps to the boundary between the green (accept) and yellow (mark as discard eligible/low priority) regions. The **overall-rate** command marks the boundary between the yellow and red (drop) regions point for the associated policy ([Figure 6: Profile marking](#)).

Figure 6: Profile marking

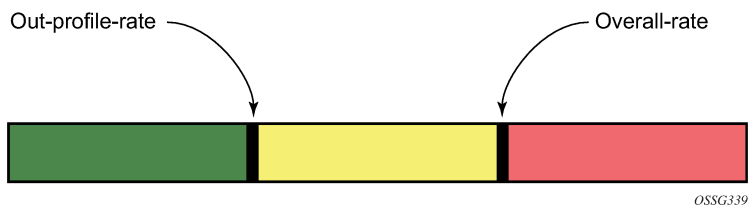

If the overall rate is set to 1000 pps and as long as the total traffic that is destined for the CPM and intended to be processed by the CPU is less than or equal to 1000 pps, all traffic is processed. If the rate exceeds 1000 pps, protocol traffic is discarded (or marked as discard eligible/low priority in the case of the **out-profile-rate** command) and traffic on the interface is affected.

This rate limit protects all the other interfaces and ensures that a violation from one interface does not affect the rest of the system.

CPU protection is not supported on 7750 SR-1, 7750 SR-1s, 7750 SR-2s, 7750 SR-e, 7750 SR-a, and 7750 VSR.

2.4.4.1 Protocol protection

Protocol protection allows traffic to be discarded for protocols not configured on the router. This helps mitigate DoS attacks by filtering invalid control traffic before it reaches the CPU. This is a feature of CPU Protection and can be enabled or disabled for the entire system.

When using the **protocol-protection** command, the system automatically maintains a per-interface list of configured protocols. For example, if an interface does not have IS-IS configured, then protocol protection discards any IS-IS packets received on that interface. Other protocols, such as L2TP, are controlled by the protocol protection at the VPRN service level.

Protocols controlled by the **protocol-protection** mechanism include:

- GTP
- IGMP
- IS-IS
- MLD
- L2TP control

- OSPFv2
- OSPFv3
- PPPoE
- PIM
- RIP
- PFCP

The following protocols are protected independently from protocol protection:

- The **per-peer-queuing** command protects BGP, LDP, T-LDP, MSDP, Telnet, and SSH.
- BFD control packets are dropped if BFD is not configured on a specific interface.

2.4.4.2 CPU protection extensions for ETH-CFM

CPU protection supports the ability to explicitly limit the amount of ETH-CFM traffic that arrives at the CPU for processing. ETH-CFM packets that are redirected to the CPU by either a Management Endpoint (MEP) or a Management Intermediate Point (MIP) will be subject to the configured limit of the associated policy. Up to four CPU protection policies may include up to ten individual ETH-CFM-specific entries. The ETH-CFM entries allow the operator to apply a packet-per-second rate limit to the matching combination of level and opcode for ETH-CFM packet that are redirected to the CPU. Any ETH-CFM traffic that is redirected to the CPU by a Management Point (MP) that does not match any entries of the applied policy is still subject to the overall rate limit of the policy itself. Any ETH-CFM packets that are not redirected to the CPU are not subject to this function and are treated as transit data, subject to the applicable QoS policy.

The operator first creates a CPU policy and includes the required ETH-CFM entries. Overlap is allowed for the entries within a policy, first match logic is applied. This means ordering the entries in the correct sequence is important to ensure the correct behavior is achieved. Even though the number of ETH-CFM entries is limited to ten, the entry numbers have a valid range from 1 to 100 to allow for ample space to insert policies between one and other.

Ranges are allowed when configuring the level and the OpCode. Ranges provide the operator a simplified method for configuring multiple combinations. When more than one level or OpCode is configured in this manner the configured rate limit is applied separately to each combination of level and OpCode match criteria. For example, if the levels are configured as listed in [Table 14: Ranges versus levels and OpCodes](#), with a range of five (5) to seven (7) and the OpCode is configured for 3,5 with a rate of 1. That restricts all possible combinations on that single entry to a rate of 1 packet-per-second. In this example, six different match conditions are created.

Table 14: Ranges versus levels and OpCodes

| Level | OpCode | Rate |
|-------|--------|------|
| 5 | 3 | 1 |
| 5 | 5 | 1 |
| 6 | 3 | 1 |
| 6 | 5 | 1 |
| 7 | 3 | 1 |

| Level | OpCode | Rate |
|-------|--------|------|
| 7 | 5 | 1 |

When the policy is created, it must be applied to a SAP or binding within a service for these rates to take effect. This means the rate is on a per-SAP or per-binding basis. Only one policy may be applied to each SAP or binding. The **eth-cfm-monitoring** command must be configured in order for the ETH-CFM entries to be applied when the policy is applied to the SAP or binding. If this command is not configured, ETH-CFM entries in the policy are ignored. It is also possible to apply a policy to a SAP or binding by configuring the **eth-cfm-monitoring** command which does not have an MP. In this case, although these entries are enforced, no packets are redirected to the CPU.

By default, rates are applied on a per-peer basis. This means each individual peer is subject to the rate. Use the **aggregate** command to apply the rate to all peers. MIPs, for example, only respond to loopback messages and linktrace messages. These are typically on-demand functions and per-peer rate limiting is not required, making the aggregate function more appealing.

The **eth-cfm-monitoring** and **mac-monitoring** commands are mutually exclusive and cannot be configured on the same SAP or binding. The **mac-monitoring** command is used in combination with the traditional CPU protection and is not specific to ETH-CFM rate limiting feature described here.

When an MP is configured on a SAP or binding within a service which allows an external source to communicate with that MP, for example a User to Network Interface (UNI), **eth-cfm-monitoring** command with the **aggregate** command should be configured on all SAPs or bindings to provide the highest level of rate control.

The following example shows a policy configuration and the application of that policy to a SAP in a VPLS service configured with an MP. Policy 1 entry 10 limits all ETH-CFM traffic redirected to the CPU for all possible combinations to 1 packet-per-second. Policy 1 entry 20 limits all possible combinations to a rate of zero, dropping all request which match any combination. If entry 20 did not exist then only rate limiting of the entry 10 matches would occur and any other ETH-CFM packets redirected to the CPU would not be bound by a CPU protection rate.

Example: MD-CLI

```
[ex:/configure system security cpu-protection policy 1 eth-cfm]
A:admin@node-2# info
  entry 10 {
    pir 1
    level start 5 end 7 { }
    opcode start 3 end 3 { }
    opcode start 5 end 5 { }
  }
  entry 20 {
    pir 0
    level start 0 end 7 { }
    opcode start 0 end 255 { }
  }

[ex:/configure service vpls "10"]
A:admin@node-2# info
  sap 1/1/4:100 {
    admin-state enable
    cpu-protection {
      policy-id 1
      eth-cfm-monitoring {
        aggregate
      }
    }
  }
```

```

eth-cfm {
    mip primary-vlan none {
    }
}

```

Example: classic CLI

```

A:node-2>config>sys>security>cpu-protection#
policy 1
eth-cfm
entry 10 level 5-7 opcode 3,5 rate 1
entry 20 level 0-7 opcode 0-255 rate 0

A:node-2>config>service>vpls#
sap 1/1/4:100
cpu-protection 1 eth-cfm-monitoring aggregate
eth-cfm
mip
no shutdown

```

2.4.4.3 ETH-CFM ingress squelching

CPU protection provides a granular method to control which ETH-CFM packets are processed. As indicated in [CPU protection extensions for ETH-CFM](#), a unique rate can be applied to ETH-CFM packets classifying on specific MD-level and a specific OpCode and applied to both ingress (down MEP and ingress MIP) and egress (up MEP and egress MIP) extraction. This function is to protect the CPU on extraction when a Management Point (MP) is configured.

It is also important to protect the ETH-CFM architecture deployed in the service provider network. This protection scheme varies from CPU protection. This model is used to prevent ETH-CFM frames at the service provider MD-levels from gaining access to the network even when extraction is not in place. ETH-CFM squelching drops all ETH-CFM packets at or below the configured MD-level. The ETH-CFM squelch feature is supported at ingress only.

[Figure 7: ETH-CFM hierarchical model](#) shows a typical ETH-CFM hierarchical model with a subscriber ME (6), test ME (5), EVC ME (4) and an operator ME (2). This model provides the necessary transparency at each level of the architecture. For security reasons, it may be necessary to prevent errant levels from entering the service provider network at the UNI, ENNI, or other untrusted interconnection points. Configuring squelching at level four on both UNI-N interconnection ensures that ETH-CFM packets matching the SAP or binding delimited configuration will silently discard ETH-CFM packets at ingress.

Figure 7: ETH-CFM hierarchical model

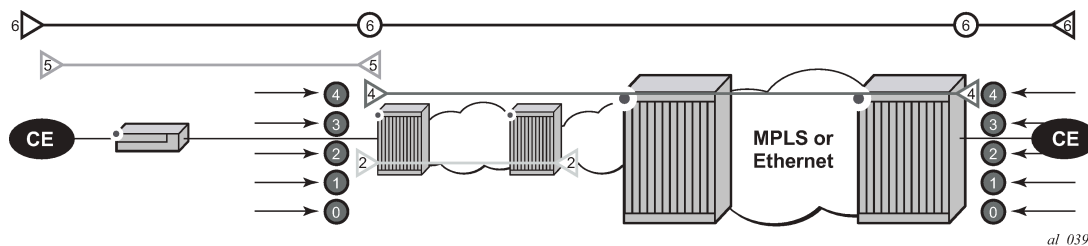

Squelching configuration uses a single MD-level (0 to 7) to silently drop all ETH-CFM packets matching the SAP or binding delimited configuration at or below the specified MD-level. In [Figure 7: ETH-CFM](#)

[hierarchical model](#), a squelch level is configured at MD-level 4. This means the configuration will silently discard MD-levels 0,1,2,3 and 4, assuming there is a SAP or binding match.



Caution: Use extreme caution when deploying this feature.

The operator is able to configure down MEPs and ingress MIPs that conflict with the squelched levels. This means that any existing MEP or MIP processing ingress CFM packets on a SAP or binding where a squelching policy is configured will be interrupted as soon as this command is entered into the configuration. These MPs are not able to receive any ingress ETH-CFM frames because squelching is processed before ETH-CFM extraction.

CPU protection extensions for ETH-CFM are still required in the model above because the subscriber ME (6) and the test ME (5) are entering the network across an untrusted connection, the UNI. ETH-CFM squelching and CPU protection for ETH-CFM can be configured on the same SAP or binding. Squelching is processed followed by CPU protection for ETH-CFM.

MPs configured to support primary VLANs are not subjected to the squelch function. Primary VLAN-based MPs, supported only on Ethernet SAPs, are extractions that take into consideration an additional VLAN beyond the SAP configuration.

The difference in the two protection mechanisms is shown in the [Table 15: CPU protection and squelching](#). CPU protection is used to control access to the CPU resources when processing is required. Squelching is required when the operator is protecting the ETH-CFM architecture from external sources.

Table 15: CPU protection and squelching

| Description | CPU protection extension for ETH-CFM | ETH-CFM squelching |
|----------------------|--|------------------------|
| Ingress filtering | Yes | Yes |
| Egress filtering | Yes | — |
| Granularity | Specified level and OpCode | Level (at and below) |
| Rate | Configurable rate (includes 0= drop all) | Silent drop |
| Primary VLAN support | Rate shared with SAP delineation | Not exposed to squelch |
| Extraction | Requires MEP or MIP to extract | No MEP or MIP required |

Use the following commands to display squelching information.

```
show service service-id all
show service sap-using eth-cfm squelch-ingress-levels
show service sdp-using eth-cfm squelch-ingress-levels
```

Output example: show service sap-using squelch-ingress-levels

```
=====
ETH-CFM Squelching
=====
PortId          SvcId          Squelch Level
```

```

-----
6/1/1:100.*      1      0 1 2 3 4 5 6 7
lag-1:100.*     1      0 1 2 3 4
6/1/1:200.*     2      0 1 2
lag-1:200.*     2      0 1 2 3 4 5
-----
Number of SAPs: 4
-----

```

Output example: show service sdp-using squelch-ingress-levels

```

=====
ETH-CFM Squelching
=====
SdpId           SvcId           Type Far End           Squelch Level
-----
12345:4000000000 2147483650     Spok 10.1.1.1         0 1 2 3 4
=====

```

2.4.5 Distributed CPU protection

Distributed CPU Protection (DCP) is a rate-limiting function distributed to the line cards to rate limit traffic extracted from the datapath and sent to the CPM CPU. DCP is performed in hardware and provides a granular per-interface and per-protocol rate-limit control.

There are two main types of DCP policies for access or network interfaces and ports. The DCP policy defines the protocols and their associated policers. The list of protocols supported depends on the type of DCP policy:

- **access network**

This type of DCP policy is used to rate limit interface level protocols and supports policing the following protocols: ARP, DHCP, HTTP redirect, ICMP, ICMP ping check, IGMP, MLD, NDIS, PPPoE-PPPoA, MPLS-TTL, BFD-CPM, BGP, ETH-CFM, IS-IS, LDP, OSPF, PIM, RSVP, VRRP, Multi-Chassis, and Multi-Chassis Sync. traffic from other protocols or unconfigured protocols is classified in the **all-unspecified** command option in the DCP protocol.

- **port**

This type of DCP policy is used to rate limit the port-level protocols LACP, Dot1X, uBFD, and ELMI. The system supports LACP, BFD-CPM, and ETH-CFM as port-level protocols that can be rate limited individually. Traffic from unconfigured protocols is classified in the **all-unspecified** command option in the DCP protocol.

Use the following command to classify protocols:

- **MD-CLI**

```
configure system security dist-cpu-protection policy protocol protocol-name
```

- **classic CLI**

```
configure system security dist-cpu-protection policy protocol
```

A default DCP policy is assigned automatically to all network interfaces, access interfaces, and ports. These policies, "_default-access-policy", "_default-network-policy", and "_default-port-policy" are originally

created empty and they can be modified by the user. These default policies can be used, for example, to deploy a new DCP configuration covering all access and network interfaces or ports on the node.

Additional DCP policies can be created for interfaces or ports requiring a dedicated configuration.

If the router interface does not need DCP functionality, the user can create and explicitly assign an empty DCP policy to the router interface using the **configure router interface dist-cpu-protection** command.

2.4.5.1 Policer

The rate-limits are configured in the DCP policy using either static or dynamic policers and the action for the **exceed-action** policer command for non-conforming packets can be set to **discard**, **low-priority**, or **none**.

Static policer

Static policers are always instantiated for each endpoint to which the DCP policy is assigned.

The following example provides two simple customized default DCP policies using static policers for access and network interfaces:

- The access DCP policy is configured to drop all access traffic exceeding 6,000 pps.
- The network DCP policy marks all traffic exceeding 3,000 pps as low priority except for BGP and LDP (for example, the BGP and LDP can be rate-limited using the **per-peer-queuing** command).

Example: MD CLI

```
[ex:/configure system security dist-cpu-protection]
A:admin@node-2# info
  policy "_default-access-policy" {
    protocol all-unspecified {
      enforcement {
        static {
          policer-name "access"
        }
      }
    }
    static-policer "access" {
      exceed-action {
        action discard
      }
      rate {
        packets {
          limit 6000
          within 1
        }
      }
    }
  }
  policy "_default-network-policy" {
    protocol all-unspecified {
      enforcement {
        static {
          policer-name "network"
        }
      }
    }
    protocol bgp {
      enforcement {
        static {
```

```

        policer-name "null"
    }
}
}
protocol ldp {
    enforcement {
        static {
            policer-name "null"
        }
    }
}
static-policer "network" {
    exceed-action {
        action low-priority
    }
    rate {
        packets {
            limit 3000
            within 1
        }
    }
}
static-policer "null" {
}
}
}

```

Example: classic CLI

```

A:node-2>config>sys>security>dist-cpu-protection# info
-----
    policy "_default-access-policy" create
        static-policer "access" create
            rate packets 6000 within 1
            exceed-action discard
        exit
    protocol all-unspecified create
        enforcement static "access"
    exit
exit
policy "_default-network-policy" create
    static-policer "null" create
    exit
    static-policer "network" create
        rate packets 3000 within 1
        exceed-action low-priority
    exit
    protocol all-unspecified create
        enforcement static "network"
    exit
    protocol bgp create
        enforcement static "null"
    exit
    protocol ldp create
        enforcement static "null"
    exit
exit
-----

```

Local monitor and dynamic policer

The use of the **local-monitoring-policer** command and dynamic policers reduces the number of policers required. This can be particularly useful in a large number of endpoints, such as subscribers in ESM

networks. Instead of using multiple static policers for various protocols on each endpoints, a single policer (the local-monitoring policer) is instantiated statically for a specified endpoint and the per-protocol dynamic policers are instantiated when there is a violation of the local-monitoring policer.

Use the following command to instantiate dynamic policers from a pool allocated per line card:

```
configure card fp ingress dist-cpu-protection dynamic-enforcement-policer-pool
```

This pool of policers should be greater than the maximum number of dynamic policers expected to be in use on the card at one time.

The following example shows monitoring of the rate of ARP, ICMP, IGMP and all-unspecified traffic. If the total rate exceeds 100 packets within 10 seconds, the system creates three dynamic policers for ARP, ICMP and IGMP to rate-limit each protocol to 20 packets within 10 seconds as well as a fourth policer to rate-limit the rest of the traffic to 100 packets within 10 seconds.

Example: MD-CLI

```
[ex:/configure system security dist-cpu-protection]
A:admin@node-2# info
  policy "dynamic-policy-example" {
    description "Dynamic policing policy"
    protocol arp {
      enforcement {
        dynamic {
          mon-policer-name "local-mon"
        }
      }
      dynamic-parameters {
        exceed-action {
          action discard
        }
        rate {
          packets {
            limit 20
            within 10
          }
        }
      }
    }
    protocol icmp {
      dynamic-parameters {
        exceed-action {
          action discard
        }
        rate {
          packets {
            limit 20
            within 10
          }
        }
      }
    }
    protocol igmp {
      enforcement {
        dynamic {
          mon-policer-name "local-mon"
        }
      }
      dynamic-parameters {
        exceed-action {
          action discard
        }
      }
    }
  }
```



```

enforcement dynamic "local-mon"
dynamic-parameters
    rate packets 20 within 10
    exceed-action discard
exit
exit
protocol all-undefined create
enforcement dynamic "local-mon"
dynamic-parameters
    rate packets 100 within 10
    exceed-action discard
exit
exit
exit
-----

```

2.4.5.2 Applicability

For the access interface, most types of SAPs on Layer 2 and Layer 3 services are supported including capture SAPs, SAPs on pseudowires, B-VPLS SAPs, and VPLS template SAPs, but are not applicable to Epipe template SAPs and video ISA SAPs.

Control packets that are extracted in a VPRN service, where the packets arrived into the node through a VPLS SAP (that is, R-VPLS scenario), use the DCP policy and policer instances associated with the VPLS SAP. For VPLSs that have a Layer 3 interface bound to them, (R-VPLS), protocols such as OSPF and ARP may be configured in the DCP policy.

Control traffic that arrives on a network interface, but inside a tunnel (for example, SDP, LSP, PW) and logically terminates on a service (that is, traffic that is logically extracted by the service instead of the network interface layer itself) bypass the DCP function. The control packets are not subject to the DCP policy that is assigned to the network interface on which the packets arrived. This helps to avoid customer traffic in a service from impacting other services or the operator's infrastructure.

2.4.5.3 Log events, statistics, status, and SNMP support

Log events are supported for DCP to alert the operator to potential attacks or misconfigurations. DCP throttles the rate of events to avoid event floods when multiple parallel attacks or problems. You can enable or disable log events individually at the DCP policy level, as well as globally in the system. Use the commands in the following context to enable logs globally:

- **MD-CLI**

```
configure log log-events
```

- **classic CLI**

```
configure log event-control
```

Use the following command to display the additional statistics for the packet exceed count and policer state.

```
show router interface dist-cpu-protection
```

Use tools commands, such as the following, to identify interface violators.

```
tools dump security dist-cpu-protection violators
```

For SNMP support, see the tables and MIB objects with "Dcp" or "DCpuProt" in their name. These can be found in the following MIBs:

- TIMETRA-CHASSIS-MIB
- TIMETRA-SECURITY-MIB
- TIMETRA-SAP-MIB
- TIMETRA-VRTR-MIB

2.4.5.4 DCP policer resource management

The policer instances are a limited hardware resource on a specific forwarding plane. DCP policers (static, dynamic, local-monitor) are consumed from the overall forwarding plane policer resources (from the ingress resources if ingress and egress are partitioned). Each per-protocol policer instantiated reduces the number of FP child policers available for other purposes.

When DCP is configured with dynamic enforcement, then the operator must set aside a pool of policers that can be instantiated as dynamic enforcement policers. The number of policers reserved for this function are configurable per card or FP. The policers in this pool are not available for other purposes (normal SLA enforcement).

Static enforcement policers and local monitoring policers use policers from the normal or global policer pool on the card or FP. After a static policer is configured in a DCP policy and it is referenced by a protocol in the policy, this policer will be instantiated for each object (SAP or network interface) that is created and references the policy. If there is no policer free on the associated card or FP, then the object will not be created. Similarly, for local monitors, after a local monitoring policer is configured and referenced by a protocol, then this policer will be instantiated for each object that is created and references the policy. If there is no policer free, then the object will not be created.

Dynamic enforcement policers are allocated as needed (when the local monitor detects nonconformance) from the reserved dynamic enforcement policer pool.

When a DCP policy is applied to an object on a LAG, then a set of policers is allocated on each FP (on each line card that contains a member of the LAG). The LAG mode is ignored and the policers are always shared by all ports in the LAG on that forwarding plane on the SAP or interface. In other words, with link-mode lag a set of DCP policers are not allocated per-port in the LAG on the SAP.

To support large scale operation of DCP, and also to avoid overload conditions, a polling process is used to monitor state changes in the policers. This means there can be a delay between when an event occurs in the data plane and when the relevant state change or event notification occurs toward an operator, but in the meantime the policers are still operating and protecting the control plane.

2.4.5.5 Operational guidelines and tips

The following points offer various optional guidelines that may help an operator decide how to leverage Distributed CPU Protection.

- The rates in a policy assigned to a capture SAP should be higher than those assigned to MSAPs that will contain a single subscriber. The rates for the capture sap policy should allow for a burst of MSAP setups.
- To completely block a set of specific protocols on a specific SAP, create a single static policer with a rate of 0 and map the protocols to that policer. Dynamic policers and local monitors cannot be used to simultaneously allow some protocols but block others (the non-zero rates in the monitor would allow all protocols slip through at a low rate).
- During normal operation it is recommended to configure "log-events" (no verbose keyword) for all static policers, in the dynamic parameters of all protocols and for all local monitoring policers. The verbose keyword can be used selectively during debug, testing, tuning, and investigations.
- Packet-based rate limiting is generally recommended for low-rate subscriber-based protocols whereas kb/s rate limiting is recommended for higher rate infrastructure protocols (such as BGP).
- It is recommended to configure an **exceed-action** of low-priority for routing and infrastructure protocols. Marked packets are more likely to be discarded if there is congestion in the control plane of the router, but will get processed if there is no contention for CPU resources allowing for a work-conserving behavior in the CPM.
- To assign a different distributed CPU protection policy to a specific MSAP instance or to all MSAPs for a specific MSAP policy, assign the new policy and then use one of the following tools commands:

```
tools perform subscriber-mgmt eval-msap policy policy-name
tools perform subscriber-mgmt eval-msap msap sap-id
```



Note: The new **dist-cpu-protection** policy is also assigned to new MSAPs.

- Use the following command if needed to determine which subscriber is on a specific MSAP and then filter ("| match") on the MSAP string.

```
show service active-subs
```

- If protocol is trusted, and using the "all-undefined" protocol is not required, then avoid referencing this protocol in the policy configuration.
- If a protocol is trusted, but the all-undefined bucket is required, there are two options:
 - Avoid creating a protocol so that it is treated as part of the all-undefined bucket (but account for the packets from X in the all-undefined rate and local-mon rate).
 - Create this protocol and configure it to bypass.

2.4.6 Classification-based priority for extracted protocol traffic

The SR OS supports a set of mechanisms to protect the router control and management planes from various types of attacks, floods, and misconfigurations. Many of the mechanisms operate by default with no need for operator configuration or intervention.

One class of mechanisms employed on the router to protect against floods of control traffic involves identifying potentially harmful or malicious traffic through the use of rate measurements. Centralized CPU protection protects and isolates interfaces from each other by default by treating unexpectedly high rate control traffic on an interface as lower priority (to be discarded if the control plane experiences congestion). Distributed CPU protection can protect and isolate at a per-protocol, per-interface granularity

through configured rate profiles. These rate-based protection mechanisms make no assumptions about the contents of the packets and can be used when nothing about the packets can be trusted (for example, DSCP or source IP address, which can be spoofed).

The SR OS also supports an alternative to rate-based mechanisms for cases where the packet headers can be trusted to differentiate between good and bad control traffic. A configurable prioritization scheme can be enabled (using the **init-extract-prio-mode i3-classify** command) on a per-FP basis to initialize the drop priority of all Layer 3 extracted control traffic based on the QoS classification of the packets. This is useful, for example, in networks where the DSCP and EXP markings can be trusted as the primary method to distinguish, protect, and isolate good terminating protocol traffic from unknown or potentially harmful protocol traffic, instead of using rate-based distributed CPU protection and centralized CPU protection traffic marking and coloring mechanisms such as the **out-profile-rate** or **exceed-action** commands with the action set to **low-priority**.

The following are the operational guidelines for deploying classification-based priority for extracted control traffic:

- Centralized CPU protection should be effectively disabled for all interfaces/SAPs on FPs configured in **i3-classify** mode by changing some CPU protection policy parameters from their default values. This is required so that centralized CPU protection does not re-mark good control traffic (traffic that was initially classified as high priority) as low priority if a flood attack occurs on the same interface. Effectively disabling centralized CPU protection can be done by ensuring the following:
 - a rate value of **max** is configured for **port-overall-rate** command (**max** is the default value for **port-overall-rate** command)
 - all objects (interfaces, MSAP policies, and SAPs) that can be assigned a CPU protection policy are referencing a policy that sets the **out-profile-rate** command to **max** and the **overall-rate** command to **max** (this can be done in the two default CPU protection policies if all FPs in the system are in **i3-classify** mode)
- DCP can be used in conjunction with **i3-classify** mode, but care must be taken to prevent DCP from acting on protocols where the operator wants to use QoS classification (such as DSCP or EXP) to differentiate between good and bad Layer 3 packets. On an FP with **i3-classify** mode, configure DCP so that BGP, LDP, and other protocols do not have their initial drop priority (color) overwritten by DCP if the QoS classification of these protocols is trusted. To achieve this, use **none** as the action for the **exceed-action** command, for those protocols in the DCP policy. For other protocols where QoS classification cannot be used to distinguish between good and bad extracted packets, use DCP to color the packets with a drop priority based on a configured rate.
- If any LAG member is on an FP in **i3-classify** mode, all FPs that host the other members of that LAG should also be in **i3-classify** mode.
- The QoS classification rules that are used on interfaces and SAPs on FPs in **i3-classify** mode should be configured to differentiate between good and bad control traffic. The default network ingress QoS policies do differentiate (for example, based on DSCP), however the default access ingress QoS policies do not.

The **i3-classify** mode for extracted control traffic is supported on the 7750 SR and 7950 XRS.

2.4.7 TTL security

The SR OS TTL security evaluates the value of the incoming packets against a maximum TTL value configured in the system. This capability, also known as Generalized TTL Security Mechanism (GTSM) defined in RFC 5082, is supported for BGP, LDP, SSH and Telnet. If the incoming TTL value is less

than the configured TTL value, the packets are discarded and a log is generated preventing attackers generating spoof traffic with larger number of hops than expected.

The TTL value is configurable on a per-peer basis for BGP and LDP and configurable at the system level for SSH and Telnet.

The TTL security mechanism was originally designed to protect the BGP infrastructure where the vast majority of ISP External Border Gateway Protocol (EBGP) peerings are established between adjacent routers. Because TTL spoofing cannot be performed, a mechanism based on an expected TTL value provides a simple and robust defense from infrastructure attacks based on forged BGP packets.

While TTL security is most effective in protecting directly-connected BGP or LDP peers, it can also provide protection to multi-hop sessions. For multi-hop sessions the expected TTL value can be set to 255 minus the configured range of hops.

2.4.8 Management Access Filter

The CPM CPU uses Management Access Filter (MAF) filters to perform filtering that applies to both traffic from the line cards directed to the CPM CPU as well as traffic from the management Ethernet port.

2.4.8.1 MAF filter packet match

You can configure three different management-access filter policies: IP filter, IPv6 filter, and MAC filter. Each policy is an ordered list of entries. For this reason, you must sequence the entries correctly from the most to the least explicit.

Management Access filter (MAF) packet match rules:

- Each MAF policy is an ordered list of entries, therefore entries must be sequenced correctly from the most to the least explicit.
- If multiple match criteria are specified in a single MAF filter policy entry, all criteria must be met for the packet to be considered a match against that policy entry (logical AND).
- Any match criteria not explicitly defined is ignored during a match.
- A MAF filter policy entry with match criteria defined, but no action configured, inherits the default action.
- The default action for the **management-access-filter** filter entry applies individually per IPv4, IPv6, or MAC CPM filter policies that are in an enabled state.
- When both **mac-filter** and **ip-filter** or **ipv6-filter** are applied to a specific packet, the **mac-filter** is applied first.

2.4.8.2 MAF IPv4/IPv6 filter entry match criteria

[Table 16: IPv4 and IPv6 match criteria](#) lists the supported IPv4 and IPv6 match criteria.

Table 16: IPv4 and IPv6 match criteria

| Criteria | Description |
|----------|--|
| src-ip | Matches the specified source IPv4 or IPv6 address prefix and mask against the source IPv4 or IPv6 address field in the IP packet |

| Criteria | Description |
|-----------------|---|
| | header. IPv4 and IPv6 matching prefix-lists can be used to enhance matching capabilities. |
| next-header | Matches the specified upper-layer protocol (such as TCP, UDP, or IGMPv6) against the next-header field of the IPv6 packet header. "*" can be used to specify a TCP or UDP upper-layer protocol match (Logical OR). Next-header matching allows also matching on presence of a subset of IPv6 extension headers. See the CLI section for details on which extension header match is supported. |
| protocol | Matches the specified protocol against the Protocol field in the IPv4 packet header (for example, TCP, UDP, or IGMP) of the outer IPv4. "*" can be used to specify TCP or UDP upper-layer protocol match (Logical OR). |
| dst-port | Matches the specified port value against the destination port number of the UDP or TCP packet header. |
| flow-label | Matches the IPv6 flow label. |
| router instance | Matches the router instance packets that are ingressing from for this filter entry. |
| src-port | Matches the port packets that are ingressing from for this filter entry. |

2.4.8.3 MAF MAC filter entry match criteria

[Table 17: Router instance match criteria](#) describes the supported MAC match criteria. The criteria are evaluated against the Ethernet header of the Ethernet frame.

Table 17: Router instance match criteria

| Criteria | Description |
|------------|--|
| frame-type | Matches a specific type of frame format. |
| src-mac | Matches the specified source MAC address frames. Optionally, operators can configure a mask to be used in a match. |
| dst-mac | Matches the specified destination MAC address frames. Optionally, operators can configure a mask to be used in a match. |
| dot1p | Matches 802.1p frames. Optionally, operators can configure a mask to be used in a match. |
| etype | Matches the specified Ethernet II frames. The Ethernet type field is a two-byte field used to identify the protocol carried by the Ethernet frame. |
| snap-oui | Matches frames with the specified three-byte OUI field. |

| Criteria | Description |
|--------------|---|
| snap-pid | Matches frames with the specified two-byte protocol ID that follows the three-byte OUI field. |
| ssap | Matches the specified frames with a source access point on the network node designated in the source field of the packet. Optionally, operators can configure a mask to be used in a match. |
| dsap | Matches the specified frames with a destination access point on the network node designated in the destination field of the packet. Optionally, operators can configure a mask to be used in a match. |
| CFM opcode | Matches the specified packet with the specified CFM opcode. |
| service ID | Matches the service ID packets are ingressing from. |
| service name | Matches the service name packets are ingressing from. |

2.4.8.4 MAF filter policy action

Management-access filter policies support the following traffic configuration actions:

- **MD-CLI**
Supported actions are **ignore-match**, **accept**, **drop**, and **reject**.
- **classic CLI**
Supported actions are **permit**, **deny**, and **deny-host-unreachable**.

2.4.8.5 MAF filter policy statistics and logging

Management access filter match count can be displayed using **show** commands. Logging is recorded in the system security logs.

2.5 Other security features

This section describes the other security features supported by the SR OS.

2.5.1 SSH

Secure Shell (SSH) is a protocol that provides a secure, encrypted Telnet-like connection to a router. A connection is always initiated by the client (the user). Authentication uses one of the configured authentication methods (local, RADIUS, TACACS+, or LDAP). With authentication and encryption, SSH allows for a secure connection over an insecure network.

SR OS supports SSH version 2 (SSHv2) only. When a configuration contains SSHv1, SSHv1 is deprecated from the configuration, and the configuration migrates to SSHv2 using the default cipher list.

SSH runs on top of a transport layer (like TCP or IP) and provides authentication and encryption capabilities.

SR OS has a global SSH server process to support inbound SSH, SFTP, NETCONF, and SCP sessions initiated by external client applications. This server process is separate from the SSH and SCP client commands on the routers which initiate outbound SSH and SCP sessions.

Inbound SSH, Telnet, and FTP sessions are counted separately. Use the following command to set the limit for each type separately.

```
configure system login-control
```

However, there is a maximum total of 50 sessions for SSH and Telnet together. SCP, SFTP, and NETCONF sessions are counted as SSH sessions.

When the SSH server is enabled, an SSH security key is generated. Unless the **preserve-key** command option is configured for SSH, the security key is only valid until the node is restarted or the SSH server is stopped and restarted. The key size is non-configurable and set to 2048 for SSHv2 RSA, and to 1024 for SSHv2 DSA. Only SSHv2 RSA is supported in FIPS mode. When the server is enabled, all inbound SSH, SCP, SFTP, and NETCONF sessions will be accepted provided the session is properly authenticated.

When the global SSH server process is disabled, no inbound SSH, SCP, SFTP, or NETCONF sessions are accepted.

When using SCP to copy files from an external device to the file system, the SCP server accepts either forward slash ("/") or backslash ("\") characters to delimit directory and filenames. Similarly, the SCP client application can use either slash or backslash characters, but not all SCP clients treat backslash characters as equivalent to slash characters. In particular, UNIX systems can interpret the backslash character as an "escape" character which is not transmitted to the SCP server. For example, a destination directory specified as "cfl:\dir1\file1" is transmitted to the SCP server as "cfl:dir1file1", where the backslash escape characters are stripped by the SCP client system before transmission. On systems where the client treats the backslash like an "escape" character, a double backslash "\\" or the forward slash "/" can be used to properly delimit directories and the filename.

There are three pairs of configurable lists: cipher lists, MAC lists, and KEX lists. In each pair, one list is dedicated to the SSH server, and a second list is dedicated to the SSH/SCP client. These can be configured for negotiation of the best compatible cipher, MAC, and KEX algorithm between the client and server. The lists can be created and managed under the **security ssh** context. The client lists are used when the SR OS is acting as the SSH client and the server lists are used when the SR OS is acting as a server. The first algorithm matched on the lists between the client and server is the preferred algorithm for the session.

SR OS supports the following SSHv2 authentication methods:

- password
- keyboard-interactive
- public key

SR OS SSH supports multichannel within a single connection. The primary connection authenticates the user through PKI or keyboard authentication. After the primary connection is authenticated, applications like NETCONF can open multiple channel "sessions" to the server with the same connection. Currently, NETCONF and CLI can open multiple channels in the same connection. Each connection can have five channels for a maximum of 50 channels per system.

2.5.1.1 SSH PKI authentication

The SSH server also supports a public key authentication as long as the server has been previously configured to know the client's public key.

Using Public Key authentication (also known as Public Key Infrastructure - PKI) can be more secure than the existing username and password method because of the following reasons.

- A user typically re-uses the same password with multiple servers. If the password is compromised, the user must reconfigure the password on all affected servers.
- A password is not transmitted between the client and server using PKI. Instead the sensitive information (the private key) is kept on the client. Therefore the password is less likely to be compromised.

SR OS supports server-side SSHv2 public key authentication but does not include a key-generation utility.

Support for PKI should be configured in the system-level configuration where one or more public keys may be bound to a username. This configuration does not affect any other system security or login functions.

PKI has preference over password or keyboard authentication. PKI is supported using local authentication and using an AAA server with LDAP only. PKI authentication is not supported on TACACS+ or RADIUS, and users with public keys always use local authentication only.

2.5.1.1.1 User public key generation

Before you can use SSH with PKI, you must generate a public and private key pair. This is typically supported by the SSH client software. For example, PuTTY supports a utility called PuTTYGen that generates key pairs.

SR OS currently supports only RSA and ECDSA user public keys.

If using PuTTY, first generate a key pair using PuTTYGen, set the key type to SSH-2 RSA, and specify the number of bits to use for the key. You can also configure a passphrase to use to store the key locally in encrypted form. If configured, the passphrase acts as a password that you must enter to use the private key. If you do not use a passphrase, the key is stored in plain text locally.

Use the following command to configure the public key for the user on SR OS:

- **MD-CLI**

```
configure system security user-params local-user user public-keys
```

- **classic CLI**

```
configure system security user public-keys
```

On SR OS, you can program the public key using Telnet/SSH or SNMP.

2.5.1.1.2 Public key authentication

Public key authentication is configured per user. If public key authentication fails, the system offers username and password authentication. If the user does not change the default password and the SSH public key authentication fails, this represents a security risk.

SR OS supports standalone public key authentication without offering username and password authentication using the CLI configuration. This configuration is per user or per system and is disabled by default (that is, the system offers keyboard authentication).

The SR OS server operates as follows:

- By default, it allows public key and password authentication.
- When RADIUS or TACPLUS interactive authentication is enabled, public key and password or keyboard authentication and password is allowed by default.
- The user can enable public key-only authentication per system or per user. This configuration is disabled by default. The user configuration has a higher priority than the system configuration.
- If **interactive-authentication** is enabled in the following contexts the SSH server also accepts interactive keyboard authentication:

- **MD-CLI**

```
configure system security aaa remote-servers radius
configure system security aaa remote-servers tacplus
```

- **classic CLI**

```
configure system security radius
configure system security tacplus
```

- When the **public-key-only** command option is enabled, the server negotiates only the public key method and does not allow password or keyboard interactive login. Even if the password authentication order is “**radius, tacplus, ldap, local**” and the following command is configured, the server does not negotiate or accept keyboard authentication.

- **MD-CLI**

```
configure system security aaa remote-servers radius interactive-authentication true
```

- **classic CLI**

```
configure system security radius interactive-authentication
```

- If **public-key-only** is enabled at the system level, this configuration must be turned off for a specific user to support password or keyword authentication for that user.

2.5.1.1.3 Public key authentication and AAA interaction

When public key-only authentication is enabled, the username and password or keyboard authentication using AAA servers is not allowed, even if the authentication order is set to prefer the AAA server. Only the LDAP server for public key authentication is allowed in this mode.

2.5.1.2 Multichannel SSH

SR OS supports opening up to five channels per SSH connection. SSH channels can be used when an SSH connection has authenticated a user and a channel is opened for configuration while another channel is required to retrieve state information, such as collecting configurations or **show** command output. In this case, some network managers attempt to set up an additional channel in the existing SSH connection.

Opening a new channel inside an existing authenticated SSH connection mitigates the additional time and memory requirements for establishing a new SSH session. This mitigation is useful when, for example, multiple RPCs from different network manager users to the same device are executed at the same time.

**Note:**

Multiple channels are only supported for SSH and some applications that use SSH as transport. Multiple channels are not supported for SFTP or SCP.

2.5.1.3 MAC client and server list

SR OS supports a configurable server and client MAC list for SSHv2. This allows the user to add or remove MAC algorithms from the list. The user can program the strong HMAC algorithms on top of the configurable MAC list (for example, lowest index in the list) in the order to be negotiated first between the client and server. The first algorithm in the list that is supported by both the client and the server is the one that is agreed upon.

There are two configurable MAC lists:

- server list
- client list

The default MAC list includes all supported algorithms with the following preference:

- mac 200 name hmac-sha2-512
- mac 210 name hmac-sha2-256
- mac 215 name hmac-sha1
- mac 220 name hmac-sha1-96
- mac 225 name hmac-md5
- mac 240 name hmac-md5-96

2.5.1.4 KEX client and server list

SR OS supports KEX client and server lists. The user can remove or add the needed KEX client/server algorithms to be negotiated using an SSHv2 phase one handshake. The list is an index list with the lower index having higher preference in the SSH negotiation. The lowest index algorithm in the list will be negotiated first in SSH and will be on top of the negotiation list to the peer.

When no KEX list entries are explicitly configured, the system will behave as if the following list is configured:

- kex 200 name diffie-hellman-group16-sha512
- kex 210 name diffie-hellman-group14-sha256
- kex 215 name diffie-hellman-group14-sha1
- kex 220 name diffie-hellman-group-exchange-sha1
- kex 225 name diffie-hellman-group1-sha1

As soon as an algorithm is configured in the KEX list, the SR OS starts using the user-defined KEX list instead of the hard-coded list.

To go back to the hard-coded list, you must remove all configured KEX indexes until the list is empty. Use the following commands inline with cipher/mac server/client lists:

- **MD-CLI**

```
delete /configure system security ssh client-kex-list-v2
```

```
delete /configure system security ssh server-kex-list-v2
```

- **classic CLI**

```
configure system security ssh client-kex-list kex
configure system security ssh client-kex-list no kex
configure system security ssh server-kex-list kex
configure system security ssh server-kex-list no kex
```

2.5.1.5 Regenerate the SSH key without disabling SSH

SR OS supports periodic rollover of the SSH symmetric key. Symmetric key rollover is important in long SSH sessions. Symmetric key rollover ensures that the encryption channel between the client and server is not jeopardized by an external hacker that is trying to break the encryption via a brute force attack.

This feature introduces symmetric key rollover on SSH client or server. The following are triggers for symmetric key rollover and negotiation:

- the negotiation of the key base on a configured time period
- the negotiation of the key base on a configured data transmission size

For extra security, by default the key re-exchange is enabled under SR OS.

2.5.1.5.1 Key re-exchange procedure

Key re-exchange is started by sending an SSH_MSG_KEXINIT packet while not already doing a key exchange. When this message is received, a party must respond with its own SSH_MSG_KEXINIT message, except in cases where the received SSH_MSG_KEXINIT already was a reply. Either party may initiate the re-exchange, but roles must not be changed (for example, the server remains the server, and the client remains the client).

Key re-exchange is performed using whatever encryption was in effect when the exchange was started. Encryption, compression, and MAC methods are not changed before a new SSH_MSG_NEWKEYS is sent after the key exchange (as in the initial key exchange). Re-exchange is processed identically to the initial key exchange, except that the session identifier remains unchanged. Some or all of the algorithms can be changed during the re-exchange. Host keys can also change. All keys and initialization vectors are recomputed after the exchange. Compression and encryption contexts are reset.

RFC 4253 recommends key exchange after every hour or 1GB of transmitted data, which is met by SR OS default implementation.

SR OS can roll over keys via two mechanisms:

- bytes (default is 1 GB and the keys are negotiated)
- minutes (default is 1 minute)



Note:

- If both the bytes and minutes key rollover mechanisms are configured, the key rollover happens based on whichever occurs first.
- If these parameters change, only new SSH connections inherit them. The existing SSH connections continue to use the previously configured parameters.

2.5.1.6 Cipher client and server list

SR OS supports cipher client and server lists. The user can add or remove the needed SSH cipher client and server algorithms to be negotiated. The list is an index list with the lower index having higher preference in the SSH negotiation. The lowest index algorithm in the list is negotiated first in SSH and is on top of the negotiation list to the peer.

The default server and client lists for SSHv2 include all supported algorithms with the following preference:

- cipher 190 name aes256-ctr
- cipher 192 name aes192-ctr
- cipher 194 name aes128-ctr
- cipher 200 name aes128-cbc
- cipher 205 name 3des-cbc
- cipher 225 name aes192-cbc
- cipher 230 name aes256-cbc

2.5.1.7 SSH session closing behavior

The SSH session closes automatically when the channel opened last in the session is closed.

SSH keepalive intervals are disabled on SR OS, which means the following:

- The SR OS SSH server does not close the session when the client SSH keepalive intervals time out.
- The client SSH keepalive intervals cannot be used to keep the connection to the SR OS server open.

2.5.1.8 CLI and SNMP considerations

Support for SSH version 1 (SSHv1) has been removed from SR OS. The following considerations apply when upgrading from a pre-22.10 release.



Note: This information applies for the classic CLI.

An In-Service Software Upgrade (ISSU) conversion must be performed to filter previously existing ciphers and set the SSH version to **2**. The customers using version 1 are switched to version 2 with default ciphers and HMAC algorithms. The default cipher set is auto-created.

SNMP

All SNMP objects remain intact. Although SSH version 1 is not visible in the **info** or **show** commands, the SNMP objects are present in the MIB and cannot be set. Attempting to configure blocked version 2 ciphers or version 1 settings returns an error.

2.5.2 Exponential login backoff

A malicious user may attempt to gain CLI access by means of a dictionary attack using a script to automatically attempt to login as an "admin" user and using a dictionary list to test all possible passwords.

Using the exponential-back off feature in the **configure system login-control** context the OS increases the delay between login attempts exponentially to mitigate attacks.

When a user tries to login to a router using a Telnet or an SSH session, there are a limited number of attempts allowed to authenticate a user. The interval between the unsuccessful attempts change after each try (1, 2 and 4 seconds). If the system is configured for user lockout, then the user will be locked out when the number of attempts is exceeded.

However, if lockout is not configured, there are three password entry attempts allowed after the first failure, at fixed 1, 2 and 4 second intervals, in the first session, and then the session terminates. Users do not have an unlimited number of login attempts per session. After each failed authentication attempt, the wait period becomes longer until the maximum number of attempts is reached.

The OS terminates after four unsuccessful tries. A wait period is never longer than four seconds. The periods are fixed and restart in subsequent sessions.

Use the following system-wide configuration commands together to mitigate attacks:

- **MD-CLI**

```
configure system login-control exponential-backoff
configure system security user-params attempts
```

- **classic CLI**

```
configure system login-control exponential-backoff
configure system security password attempts
```

Exponential backoff applies to any user and by any login method such as console, SSH, and Telnet.

For more information, see [Configuring login controls](#).

2.5.3 User lockout

When a user exceeds the maximum number of attempts allowed (the default is 3 attempts) during a specific period of time (the default is 5 minutes), the account used during those attempts are locked out for a pre-configured lock-out period (the default is 10 minutes).

A security or LI event log is generated as soon as a user account has exceeded the number of allowed attempts. Use the following command to display the total number of failed attempts per user.

```
show system security user
```

In addition to the security or LI event log, an SNMP trap is also generated so that any SNMP server (including the NSP NFM-P) can use the trap for an action. The account is automatically re-enabled as soon as the lock-out period has expired.

Use the following command to display a list of users who are currently locked out.

```
show system security user lockout
```

Use the following command with the applicable option to clear a lockout for a specific **user** or **all** users:

- **MD-CLI**

```
admin clear security lockout
```

- **classic CLI**

```
admin clear logout
```

2.5.4 CLI login scripts

The SR OS supports automatic execution of CLI scripts when a user successfully logs into the router and starts a CLI session.

Use the following command to configure a login script for users who authenticate using the local user database:

- **MD-CLI**

```
configure system security user-params local-user user console login-exec file-url
```

- **classic CLI**

```
configure system security user console login-exec file-url
```

You can configure a global login-script to execute a common script when any user logs into the CLI. You can also configure a per-user login-script to execute when a specific user logs into the CLI. These login-scripts execute when the user is authenticated using the local user database, TACACS+, or RADIUS.

Use the following command to configure a global login script:

- **MD-CLI**

```
configure system login-control login-scripts global-script global-login-script-url
```

- **classic CLI**

```
configure system login-control login-scripts global global-login-script-url
```

Use the following command to configure a user-specific login script pointing to a user-defined directory:

- **MD-CLI**

```
configure system login-control login-scripts per-user-script user-directory dir-url
```

- **classic CLI**

```
configure system login-control login-scripts per-user user-directory dir-url file-name file-name
```

2.5.5 File access controls

Access files on the router locally using the CLI **file** commands and output modifiers, such as **>** (file redirect), or remotely via FTP and SCP. SR OS provides file access controls that allow an administrator to create users with different permissions; for example:

- access to all files and the ability to save the configuration
- access to home directory files only and the ability to save the configuration

- access to home directory files only and no ability to save the configuration
- no file access and no ability to save the configuration

The file access controls provide different levels of user access depending on user privileges. File access controls can also be configured to allow users to save the configuration to a system file that is stored outside their home directory when their file access is restricted to their home directory.

A home directory is typically a working space for the user, for example `cf3:\users\user1`. Although the home directory can be configured to contain saved configuration files, log files, or other system files.



Note: Take care to only configure a home directory for users who are intended to have access to those files.

The following controls affect file access for local or remote users, and can be set via the CLI, TACACS+ VSAs, or RADIUS VSAs:

- restricted to home – restrict file access to the home directory of the user
- home directory – home directory for the user. Nokia recommends users do not configure this parameter in the TACACS+ or RADIUS default template because each user should have their own home directory.
- save when restricted – save configurations when the user is restricted to their home directory, even if the saved configuration file is outside the home directory of the user

High-privilege users and administrators have access to the router configuration file via the CLI, SCP, and SFTP, and must be trusted.

Medium-privilege and low-privilege users with access to a subset of the configuration must be configured with “restricted to home” and a “home directory” to restrict their access to the file system via the CLI, SCP, and SFTP. The “home directory” must not contain the saved configuration file.

The following table lists examples of various types of users and privileges with the corresponding file access control configuration.

Table 18: File access control configuration

| Type of user | File system access | Configuration access | Restricted to home | Home directory | Save when restricted |
|--|---|----------------------|--------------------|--|----------------------|
| High-privilege administrator | Full | Yes | Disabled (false) | Unconfigured | Unconfigured |
| High-privilege user with access to all configuration | Private directory with environment settings and Python applications | Yes | Enabled (true) | <code>cf3:\users\user1</code> | Enabled (true) |
| Medium-privilege user with access to a subset of configuration using AAA | Directory of CLI scripts and Python applications | Yes | Enabled (true) | <code>cf3:\scripts\script-group-a</code> | Enabled (true) |

| Type of user | File system access | Configuration access | Restricted to home | Home directory | Save when restricted |
|--|---|----------------------|--------------------|------------------|---------------------------|
| command authorization | | | | | |
| Medium-privilege user with access to a subset of configuration using AAA command authorization | None | Yes | Enabled (true) | Unconfigured | Enabled (true) |
| Low-privilege operational user | Private directory with environment settings and operational scripts | No | Enabled (true) | cf3:\users\user2 | Unconfigured ³ |
| Low-privilege operational user | None | No | Enabled (true) | Unconfigured | Unconfigured ³ |
| Low-privilege user for managing XML accounting files | Accounting directory | No | Enabled (true) | cf2:\act | Unconfigured ³ |
| Low-privilege user for managing log files | Log directory | No | Enabled (true) | cf2:\log | Unconfigured ³ |

The following examples show how to use the CLI to configure different permissions for local users. The administrator must create a home directory for each user.

Example: Access to all files and the ability to save the configuration

Use the following configuration for a high-privilege administrator that needs access to all files:

- **MD-CLI**

```
configure system security user-params local-user user user1 restricted-to-home false
```

- **classic CLI**

```
configure system security user user1 no restricted-to-home
```

³ Configuration save operations (for example, **admin save**) are controlled by AAA command authorization. Optionally, “save when restricted” can be disabled to explicitly deny configuration save operations for these user types.

Example: Access to home directory files only and the ability to save the configuration

Use the following configuration for a medium-privilege user who can access some parts of the configuration and needs to save the configuration, but is denied access to other parts of the configuration in a AAA profile:

- **MD-CLI**

```
configure system security user-params local-user user user2 home-directory "cf3:\users\user2"
configure system security user-params local-user user user2 restricted-to-home true
configure system security user-params local-user user user2 save-when-restricted true
```

- **classic CLI**

```
configure system security user user2 home-directory "cf3:\users\user2"
configure system security user user2 restricted-to-home
configure system security user user2 save-when-restricted
```

Example: Access to home directory files only and no ability to save the configuration

Use the following configuration for a low-privilege user who does not have access to any part of the configuration, but still requires a working area on the file system for their own files:

- **MD-CLI**

```
configure system security user-params local-user user user3 home-directory "cf3:\users\user3"
configure system security user-params local-user user user3 restricted-to-home true
configure system security user-params local-user user user3 save-when-restricted false
```

- **classic CLI**

```
configure system security user user3 home-directory "cf3:\users\user3"
configure system security user user3 restricted-to-home
configure system security user user3 no save-when-restricted
```

Example: No file access and no ability to save the configuration

Use the following configuration for a low-privilege user who does not have access to any part of the configuration, and does not require any file system access:

- **MD-CLI**

```
configure system security user-params local-user user user4 restricted-to-home true
configure system security user-params local-user user user4 save-when-restricted false
```

- **classic CLI**

```
configure system security user user4 restricted-to-home
configure system security user user4 no save-when-restricted
```

For configuration examples using RADIUS VSAs, see [RADIUS configuration for file access control using VSAs](#) and for configuration examples using TACACS+ VSAs, see the [TACACS+ configuration for file access control using VSAs](#).

2.5.6 802.1x network access control

The SR OS supports network access control of client devices (PCs, STBs, and so on) on an Ethernet network using the IEEE. 802.1x standard. 802.1x is known as Extensible Authentication Protocol (EAP) over a LAN network or EAPOL.

2.5.7 TCP Enhanced Authentication Option

The TCP Enhanced Authentication Option, currently covered in RFC 5925, *The TCP Authentication Option*, extends the previous MD5 authentication option to include the ability to change keys without tearing down the session, and allows for stronger authentication algorithms to be used.

The TCP Enhanced Authentication Option is a TCP extension that enhances security for BGP, LDP and other TCP-based protocols. This includes the ability to change keys in a BGP or LDP session seamlessly without tearing down the session. It is intended for applications where secure administrative access to both the end-points of the TCP connection is normally available.

TCP peers can use this extension to authenticate messages passed between one another. This strategy improves upon current practice, which is described in RFC 2385, *Protection of BGP Sessions via the TCP MD5 Signature Option*. Using this new strategy, TCP peers can update authentication keys during the lifetime of a TCP connection. TCP peers can also use stronger authentication algorithms to authenticate routing messages.

2.5.7.1 Packet formats

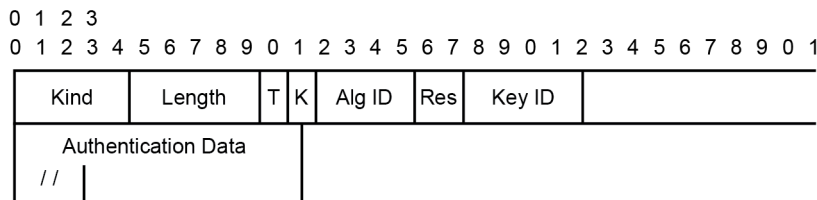

sw4109

Option Syntax:

- Kind: 8 bits
The Kind field identifies the TCP Enhanced Authentication Option. This value is assigned by IANA.
- Length: 8 bits
The Length field specifies the length of the TCP Enhanced Authentication Option, in octets. This count includes two octets representing the Kind and Length fields.
The valid range for this field is from 4 to 40 octets, inclusive.
For all algorithms specified in this memo the value is 16 octets.
- T-Bit: 1 bit
The T-bit specifies whether TCP Options were omitted from the TCP header for the purpose of MAC calculation. A value of 1 indicates that all TCP options other than the Extended Authentication Option were omitted. A value of 0 indicates that TCP options were included.
The default value is 0.
- K-Bit: 1 bit

This bit is reserved for future enhancement. Its value must be equal to zero.

- Alg ID: 6 bits

The Alg ID field identifies the MAC algorithm.

- Res: 2 bits

These bits are reserved. They must be set to zero.

Key ID: 6 bits

The Key ID field identifies the key that was used to generate the message digest.

- Authentication Data: Variable length

- The Authentication Data field contains data that is used to authenticate the TCP segment. This data includes, but need not be restricted to, a MAC. The length and format of the Authentication Data Field can be derived from the Alg ID.

- The Authentication for TCP-based Routing and Management Protocols draft provides an overview of the TCP Enhanced Authentication Option. The details of this feature are described in *draft-bonica-tcp-auth-04.txt*.

2.5.7.2 Keychain

The keychain mechanism allows for the creation of keys used to authenticate protocol communications. Each keychain entry defines the authentication attributes to be used in authenticating protocol messages from remote peers or neighbors, and it must include at least one key entry to be valid. Through the use of the keychain mechanism, authentication keys can be changed without affecting the state of the associated protocol adjacencies for OSPF, IS-IS, BGP, LDP, and RSVP-TE.

Each key within a keychain must include the following attributes for the authentication of protocol messages:

- key identifier
- authentication algorithm
- authentication key
- direction
- start time

In addition, additional attributes can be optionally specified, including:

- end time
- tolerance

[Table 19: Keychain mapping](#) shows the mapping between these attributes and the CLI command to set them.

Table 19: Keychain mapping

| Definition | Configuration |
|--|---|
| The key identifier expressed as an integer (0..63) | MD-CLI <pre>configure system security keychains keychain bidirectional entry configure system security keychains keychain receive entry</pre> |

| Definition | Configuration |
|--|---|
| | <pre>configure system security keychains keychain send entry</pre> <p>classic CLI</p> <pre>configure system security keychain direction bi entry configure system security keychain direction uni receive entry configure system security keychain direction uni send entry</pre> |
| Authentication algorithm to use with key[i] | <p>MD-CLI</p> <pre>configure system security keychains keychain bidirectional entry algorithm configure system security keychains keychain receive entry algorithm configure system security keychains keychain send entry algorithm</pre> <p>classic CLI</p> <pre>configure system security keychain direction bi entry key algorithm configure system security keychain direction uni receive entry key algorithm configure system security keychain direction uni send entry key algorithm</pre> |
| Shared secret to use with key[i] | <p>Use the shared secret with the following:</p> <ul style="list-style-type: none"> <p>MD-CLI</p> <pre>configure system security keychains keychain bidirectional entry configure system security keychains keychain receive entry configure system security keychains keychain send entry</pre> <p>classic CLI</p> <pre>configure system security keychain direction bi entry configure system security keychain direction uni receive entry configure system security keychain direction uni send entry</pre> |
| A vector that determines whether the key[i] is to be used to generate MACs for inbound segments, outbound segments, or both. | <p>MD-CLI</p> <pre>configure system security keychains keychain bidirectional entry configure system security keychains keychain receive entry configure system security keychains keychain send entry</pre> <p>classic CLI</p> <pre>configure system security keychain direction bi entry configure system security keychain direction uni receive entry configure system security keychain direction uni send entry</pre> |
| Start time from which key[i] can be used. | <p>MD-CLI</p> <pre>configure system security keychains keychain bidirectional entry begin-time</pre> |

| Definition | Configuration |
|---|---|
| | <pre>configure system security keychains keychain send entry begin-time</pre> <p>classic CLI</p> <pre>configure system security keychain direction bi entry begin-time configure system security keychain direction uni send entry begin-time</pre> |
| End time after which key[i] cannot be used by sending TCPs. | Inferred by the begin-time of the next key (youngest key rule). |
| Start time from which key[i] can be used. | <p>MD-CLI</p> <pre>configure system security keychains keychain bidirectional entry begin-time configure system security keychains keychain bidirectional entry tolerance configure system security keychains keychain receive entry begin-time configure system security keychains keychain receive entry tolerance</pre> <p>classic CLI</p> <pre>configure system security keychain direction bi entry begin-time configure system security keychain direction bi entry tolerance configure system security keychain direction uni receive entry begin- time configure system security keychain direction uni receive entry tolerance</pre> |
| End time after which key[i] cannot be used | <p>MD-CLI</p> <pre>configure system security keychains keychain receive entry end-time</pre> <p>classic CLI</p> <pre>configure system security keychain direction uni receive entry end- time</pre> |

Table 20: Security algorithm support per protocol lists the authentication algorithms that can be used in association with specific routing protocols.

Table 20: Security algorithm support per protocol

| Protocol | Clear text | MD5 | HMAC-MD5 | HMAC-SHA-1-96 | HMAC-SHA-1 | HMAC-SHA-256 | AES-128-CMAC-96 | AES-128-CMAC-128 |
|----------|------------|-----|----------|---------------|------------|--------------|-----------------|------------------|
| OSPF | Yes | Yes | — | Yes | Yes | Yes | — | — |
| IS-IS | Yes | — | Yes | — | Yes | Yes | — | — |
| RSVP | Yes | — | Yes | — | Yes | — | — | — |

| Protocol | Clear text | MD5 | HMAC-MD5 | HMAC-SHA-1-96 | HMAC-SHA-1 | HMAC-SHA-256 | AES-128-CMAC-96 | AES-128-CMAC-128 |
|----------|------------|-----|----------|---------------|------------|--------------|-----------------|------------------|
| BGP | — | Yes | — | Yes | — | — | Yes | — |
| LDP | — | Yes | — | Yes | — | — | Yes | — |
| NTP | — | — | — | — | — | — | — | Yes |

2.5.8 gRPC authentication

gRPC communication between the client and server must be authenticated and encrypted. There are two types of authentication:

- **Authentication via session credentials**

Session credentials operate similarly to device authentication, ensuring that the device is allowed in the network and is authorized by the provider. This type of authentication is performed using PKI and X.509.3 certificates. gRPC uses TLS for session authentication.

SR OS supports TLS servers for gRPC.

- **Authentication using channel credentials**

Channel credentials use a username and password that are entered at the gRPC client terminal to authenticate gRPC packets using an AAA method.

Session authentication provides proof that the client and server are authorized devices and that they belong to the provider. After authentication, the session becomes encrypted using TLS, and gRPC PDUs are transmitted between the client and server.

Figure 8: Session authentication using TLS shows a basic session authentication using TLS.

Figure 8: Session authentication using TLS

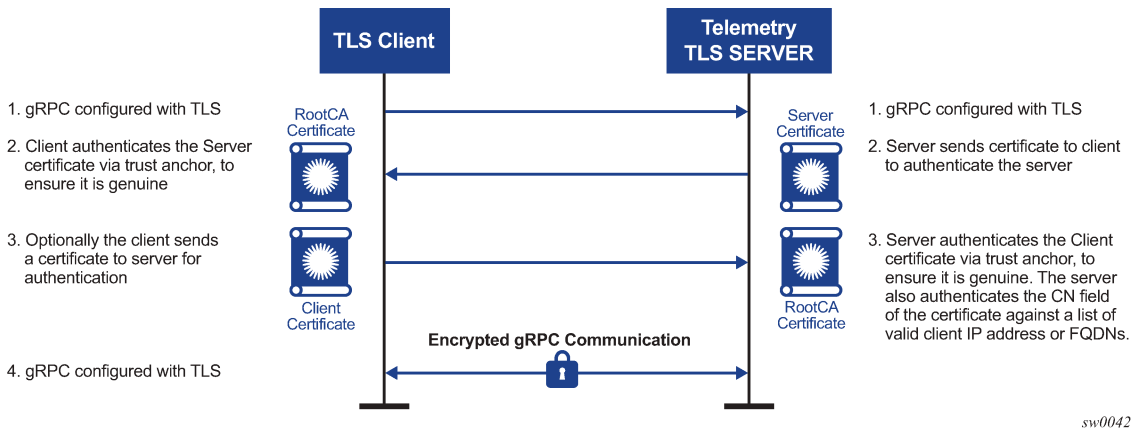

Channel credentials use username and password authentication. Each gRPC channel packet can contain a username and a password. Authentication is done through standard SR OS authentication order and mechanisms. All current authentication methods, including local and AAA servers, are applicable to gRPC channels. In addition, all authentication orders currently used by Telnet or SSH are compatible with gNMI Call authentication.

Figure 9: gNMI call authentication using SR OS shows a basic gNMI Call authentication using SR OS.

Figure 9: gNMI call authentication using SR OS

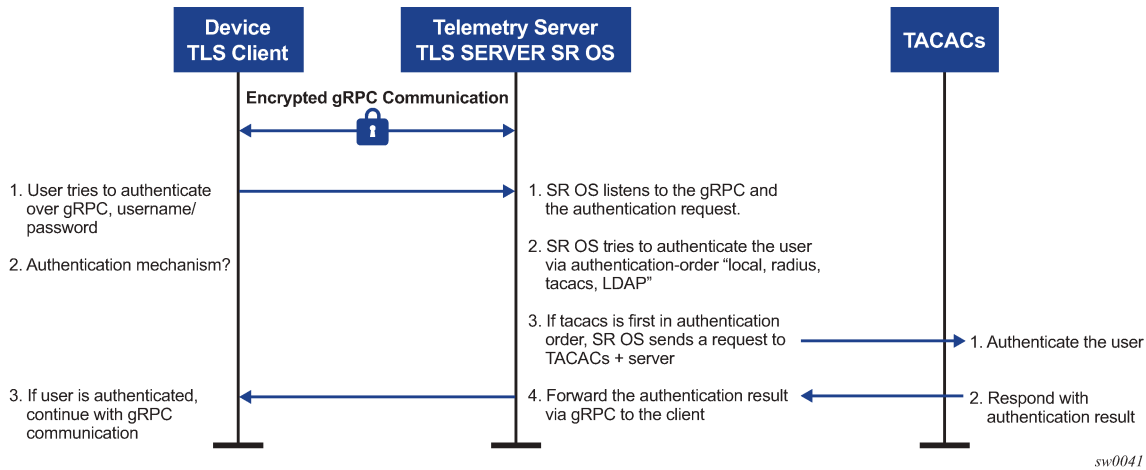

The gRPC channel packets contain the username and password in clear text, and are only encrypted using TLS. If a TLS server profile is assigned to the gRPC session, all PDUs between the server and client are encrypted. If TLS becomes operationally down, no gRPC PDUs are transmitted in clear text.

SR OS relies on existing authentication mechanisms for gRPC channels, including the following:

- Use the following command to configure AAA servers and local authentication order:

- **MD-CLI**

```
configure system security user-params authentication-order
```

- **classic CLI**

```
configure system security password authentication-order
```

- password complexity rules
- Use the following command to configure users as part of gRPC access:

- **MD-CLI**

```
configure system security user-params local-user user access grpc
```

- **classic CLI**

```
configure system security user access grpc
```

- Use **admin disconnect** to disconnect the gRPC session for the session ID



Note: The gRPC is not affected by the password aging.

Security profiles can authorize bulk **get**, **set**, and **subscribe gRPC** commands that are received by the server. Profiles can be configured to allow or deny specific gRPC commands; for example, a profile for one

user can authorize **get** and **set** commands, while a profile for another user can authorize **get** commands only.

2.5.9 Hash management per management interface configuration

Hash management is configurable per management interface for example, for the following:

- MD-CLI
- classic CLI
- NETCONF
- gRPC

Each management interface has its own write-hash algorithm. Depending on which management interface the user logs into, the write hash of that interface should be checked and used for displaying the critical phrases.

In the classic CLI interface, the read and write hash algorithms can be different, for example, hash for write and hash2 for read.

In the MD-CLI, NETCONF, and gRPC interfaces, when a hash is configured, only write is implemented using that hash algorithm. For example, if hash2 is configured, SR OS displays the phrase in hash2 format and reads the phrase in all formats. The read algorithm is not affected by hash algorithm configuration and SR OS reads in all hash formats.

2.5.9.1 Hash encryption using AES-256

Hash and hash2 use the AES-256 algorithm for all interfaces. However, hash2 uses module-specific text to make the hash unique per module or protocol. For example, BGP uses a different pre-pending text than IGP. This pre-pending text is appended to the key and then hashed using hash2.

In the classic CLI, hash has been changed to AES-256. Upgrade from DES to AES-256 is allowed and loading a config file in classic CLI with DES to a new software that supports AES-256 is also allowed.

The DES and the DES key should only be used for decryption of the old password to obtain clear text and the password should then be rehashed using AES-256. The few characters of the old hashed phrase are used to determine that the phrase is hashed using DES.

2.5.9.2 Cleartext

The cleartext option for the write algorithm displays the hash in clear text in the config file, info, info detail, and so on.

2.6 Configuring security with CLI

This section provides information to configure security using the command line interface.

2.6.1 Configuring management access filters

The following example shows a management access filter configuration that accepts packets matching the criteria specified in IP, IPv6, and MAC entries. Non-matching packets are denied.

Example: MD-CLI

```
[ex:/configure system security management-access-filter]
A:admin@node-2# info
  ip-filter {
    default-action reject
    entry 10 {
      description "Accept SSH from mgmnt subnet"
      action accept
      match {
        protocol tcp
        src-ip {
          address 192.168.5.0/26
        }
        dst-port {
          port 22
          mask 65535
        }
      }
    }
  }
  ipv6-filter {
    default-action accept
    entry 10 {
      action reject
      log-events true
      match {
        next-header rsvp
        src-ip {
          address 2001:db8:1000::/64
        }
      }
    }
  }
  mac-filter {
    default-action accept
    entry 12 {
      action accept
      match {
        service "1"
        frame-type ethernet-ii
        src-mac {
          address 00:01:01:01:01:01
          mask ff:ff:ff:ff:ff:ff
        }
      }
    }
  }
}
```

Example: classic CLI

```
A:node-2>config>system>security>mgmt-access-filter# info
-----
  ip-filter
    default-action deny
    entry 10
      description "Accept SSH from mgmnt subnet"
```

```

        src-ip 192.168.5.0/26
        protocol tcp
        dst-port 22 65535
        action permit
    exit
exit
ipv6-filter
    default-action permit
    entry 10
        src-ip 2001:db8:1000::/64
        next-header rsvp
        log
        action deny
    exit
exit
mac-filter
    default-action permit
    entry 12
        match frame-type ethernet_II
            svc-id 1
            src-mac 00:01:01:01:01:01 ff:ff:ff:ff:ff:ff
        exit
        action permit
    exit
exit
-----

```

2.6.2 Configuring IP CPM filters

Nokia recommends using a strict CPM filter policy allowing traffic from trusted IP subnets for protocols and ports actively used in the router and to explicitly drop other traffic.

The following configuration example uses these recommendations for SSH and BGP:

- allow SSH from trusted subnet only
- allow BGP from trusted subnet only
- explicitly deny all other traffic and operationally log unexpected packets

Example: MD-CLI

```

[ex:/configure system security cpm-filter]
A:admin@node-2# info
    default-action drop
    ip-filter {
        admin-state enable
        entry 100 {
            description "SSH: server terminated TCP sessions from trusted subnets"
            match {
                protocol tcp
                src-ip {
                    ip-prefix-list "trusted-mgmt-subnet"
                }
                dst-port {
                    eq 22
                    mask 65535
                }
            }
            action {
                accept
            }
        }
    }

```

```

}
entry 200 {
  description "BGP: server terminated TCP Sessions"
  match {
    protocol tcp
    src-ip {
      ip-prefix-list "trusted-bgp-subnet"
    }
    dst-port {
      eq 179
      mask 65535
    }
  }
  action {
    accept
  }
}
entry 300 {
  description "BGP: client responses for initiated TCP sessions"
  match {
    protocol tcp
    src-ip {
      ip-prefix-list "trusted-bgp-subnet"
    }
    src-port {
      eq 179
      mask 65535
    }
  }
  action {
    accept
  }
}
entry 6000 {
  description "Drop all other UDP"
  log 102
  match {
    protocol udp
  }
  action {
    drop
  }
}
entry 6010 {
  description "drop all other TCP"
  log 103
  match {
    protocol tcp
  }
  action {
    drop
  }
}
}
}

```

Example: classic CLI

```

A:node-2>config>sys>security>cpm-filter# info
-----
  default-action drop
  ip-filter
  entry 100 create
  action accept

```

```

subnets"
    description "SSH: server terminated TCP sessions from trusted
    match protocol tcp
        dst-port 22 65535
        src-ip ip-prefix-list "trusted-mgmt-subnet"
    exit
    exit
    entry 200 create
        action accept
        description "BGP: server terminated TCP Sessions"
        match protocol tcp
            dst-port 179 65535
            src-ip ip-prefix-list "trusted-bgp-subnet"
        exit
    exit
    entry 300 create
        action accept
        description "BGP: client responses for initiated TCP sessions"
        match protocol tcp
            src-ip ip-prefix-list "trusted-bgp-subnet"
            src-port 179 65535
        exit
    exit
    entry 6000 create
        action drop
        description "Drop all other UDP"
        log 102
        match protocol udp
        exit
    exit
    entry 6010 create
        action drop
        description "drop all other TCP"
        log 103
        match protocol tcp
        exit
    exit
    no shutdown
    exit
-----

```

2.6.3 Configuring IPv6 CPM filters

Nokia recommends using a strict CPM filter policy allowing traffic from trusted IP subnets for protocols and ports actively used in the router and to explicitly drop other traffic.

The following configuration example uses these recommendations for SSH and BGP:

- allow SSH from trusted subnet only
- allow BGP from trusted subnet only
- explicitly deny all other traffic and operationally log unexpected packets

Example: MD-CLI

```

[ex:/configure system security cpm-filter]
A:admin@node-2# info
    default-action drop
    ip-filter {
        admin-state enable
        entry 100 {

```

```
description "SSH: server terminated TCP sessions from trusted subnets"
match {
  protocol tcp
  src-ip {
    ip-prefix-list "trusted-mgmt-subnet"
  }
  dst-port {
    eq 22
    mask 65535
  }
}
action {
  accept
}
}
entry 200 {
  description "BGP: server terminated TCP Sessions"
  match {
    protocol tcp
    src-ip {
      ip-prefix-list "trusted-bgp-subnet"
    }
    dst-port {
      eq 179
      mask 65535
    }
  }
  action {
    accept
  }
}
entry 300 {
  description "BGP: client responses for initiated TCP sessions"
  match {
    protocol tcp
    src-ip {
      ip-prefix-list "trusted-bgp-subnet"
    }
    src-port {
      eq 179
      mask 65535
    }
  }
  action {
    accept
  }
}
entry 6000 {
  description "Drop all other UDP"
  log 102
  match {
    protocol udp
  }
  action {
    drop
  }
}
entry 6010 {
  description "drop all other TCP"
  log 103
  match {
    protocol tcp
  }
  action {
```

```
        drop
      }
    }
  }
  ipv6-filter {
    admin-state enable
    entry 100 {
      description "SSH: server terminated TCP sessions from trusted subnets"
      match {
        next-header tcp
        src-ip {
          ipv6-prefix-list "trusted-mgmt-subnet"
        }
        dst-port {
          eq 22
          mask 65535
        }
      }
      action {
        accept
      }
    }
    entry 200 {
      description "BGP: server terminated TCP Sessions"
      match {
        next-header tcp
        src-ip {
          ipv6-prefix-list "trusted-bgp-subnet"
        }
        dst-port {
          eq 179
          mask 65535
        }
      }
      action {
        accept
      }
    }
    entry 300 {
      description "BGP: client responses for initiated TCP sessions"
      match {
        next-header tcp
        src-ip {
          ipv6-prefix-list "trusted-bgp-subnet"
        }
        src-port {
          eq 179
          mask 65535
        }
      }
      action {
        accept
      }
    }
    entry 6000 {
      description "Drop all other UDP"
      log 102
      match {
        next-header udp
      }
      action {
        drop
      }
    }
  }
}
```

```

    entry 6010 {
      description "drop all other TCP"
      log 103
      match {
        next-header tcp
      }
      action {
        drop
      }
    }
  }
}

```

Example: classic CLI

```

A:node-2>config>sys>security>cpm-filter# info
-----
      default-action drop
      ip-filter
      entry 100 create
      action accept
      description "SSH: server terminated TCP sessions from trusted
subnets"
      match protocol tcp
      dst-port 22 65535
      src-ip ip-prefix-list "trusted-mgmt-subnet"
      exit
      exit
      entry 200 create
      action accept
      description "BGP: server terminated TCP Sessions"
      match protocol tcp
      dst-port 179 65535
      src-ip ip-prefix-list "trusted-bgp-subnet"
      exit
      exit
      entry 300 create
      action accept
      description "BGP: client responses for initiated TCP sessions"
      match protocol tcp
      src-ip ip-prefix-list "trusted-bgp-subnet"
      src-port 179 65535
      exit
      exit
      entry 6000 create
      action drop
      description "Drop all other UDP"
      log 102
      match protocol udp
      exit
      exit
      entry 6010 create
      action drop
      description "drop all other TCP"
      log 103
      match protocol tcp
      exit
      exit
      no shutdown
      exit
      ipv6-filter
      entry 100 create
      action accept
      description "SSH: server terminated TCP sessions from trusted

```



```

subnets"
    match next-header tcp
      dst-port 22 65535
      src-ip ipv6-prefix-list "trusted-mgmt-subnet"
    exit
  exit
  entry 200 create
    action accept
    description "BGP: server terminated TCP Sessions"
    match next-header tcp
      dst-port 179 65535
      src-ip ipv6-prefix-list "trusted-bgp-subnet"
    exit
  exit
  entry 300 create
    action accept
    description "BGP: client responses for initiated TCP sessions"
    match next-header tcp
      src-ip ipv6-prefix-list "trusted-bgp-subnet"
      src-port 179 65535
    exit
  exit
  entry 6000 create
    action drop
    description "Drop all other UDP"
    log 102
    match next-header udp
    exit
  exit
  entry 6010 create
    action drop
    description "drop all other TCP"
    log 103
    match next-header tcp
    exit
  exit
  no shutdown
exit
-----

```

2.6.4 Configuring MAC CPM filters

The following example shows a MAC CPM filter configuration.

Example: MD-CLI

```

[ex:/configure system security cpm-filter mac-filter]
A:admin@node-2# info
  admin-state enable
  entry 10 {
    description "MAC-CPM-Filter 10.10.10.100 #007"
    match
    log 101
    action {
      drop
    }
  }
  entry 20 {
    description "MAC-CPM-Filter 10.10.10.100 #008"
    match
    log 101
  }

```

```

    action {
        drop
    }
}

```

Example: classic CLI

```

A:node-2>config>sys>sec>cpm>mac-filter# info
-----
    entry 10 create
        description "MAC-CPM-Filter 10.10.10.100 #007"
        match
        exit
        log 101
        action drop
    exit
    entry 20 create
        description "MAC-CPM-Filter 10.10.10.100 #008"
        match
        exit
        log 101
        action drop
    exit
    no shutdown
-----

```

2.6.5 Configuring CPM queues

CPM queues can be used for troubleshooting purposes to provide rate limit capabilities for traffic destined for CPM as described in an earlier section of this document.

The following example displays a CPM queue configuration.

Example: MD-CLI

```

[ex:/configure system security cpm-queue]
A:admin@node-2# info
    queue 101 {
        rate {
            pir 100
        }
    }

```

Example: classic CLI

```

config>sys>security>cpm-queue# info
-----
    queue 101 create
        rate 100
    exit
-----

```

2.6.6 IPsec certificate configuration



Note: This information applies to the classic CLI.

The following example shows importation of a certificate from a PEM format.

Example: Importing a certificate from PEM format (classic CLI)

```
A:node-2# admin certificate import type cert input cf3:/pre-import/R1-0cert.pem
output R1-0cert.der format pem
```

The following example shows the exportation of a certificate to PEM format.

Example: Exporting a certificate to PEM format (classic CLI)

```
A:node-2# admin certificate export type cert input R1-0cert.der output cf3:/
R1-0cert.pem format pem
```

The following example shows certificate authority (CA) profile configuration.

Example: CA profile configuration (MD-CLI)

```
[ex:/configure system security pki]
A:admin@node-2# info
  ca-profile "Root" {
    admin-state enable
    description "Root CA"
    cert-file "R1-0cert.der"
    crl-file "R1-0crl.der"
  }
```

Example: CA profile configuration (class CLI)

```
A:node-2>config>system>security>pki# info
-----
      ca-profile "Root" create
      description "Root CA"
      cert-file "R1-0cert.der"
      crl-file "R1-0crl.der"
      no shutdown
      exit
-----
```

The following example shows IKE policy with cert-auth configuration.

Example: IKE policy with cert-auth configuration (MD-CLI)

```
[ex:/configure ipsec ike-policy 1]
A:admin@node-2# info
  ike-version-2 {
    auth-method cert
    own-auth-method psk
  }
```

Example: IKE policy with cert-auth configuration (classic CLI)

```
A:node-2>config>ipsec>ike-policy# info
```

```

-----
ike-version 2
auth-method cert-auth
own-auth-method psk
-----

```

The following example shows a static LAN-to-LAN configuration using cert-auth.

Example: Static LAN-to-LAN configuration using cert-auth (MD-CLI)

```

[ex:/configure service vprn "new"]
A:admin@node-2# info
  interface "VPRN1" {
    tunnel true
    sap tunnel-1.private:1 {
      ipsec-tunnel "Sanity-1" {
        admin-state enable
        key-exchange {
          dynamic {
            ike-policy 1
            ipsec-transform [1]
            pre-shared-key "qGAaHFZ9e/YXSsSCzLYbYwetW+Md2bDwwA== hash2"
            cert {
              cert-profile "M2cert.der"
              trust-anchor-profile "R1-0"
            }
          }
        }
      }
    }
    tunnel-endpoint {
      local-gateway-address 10.1.1.13
      remote-ip-address 10.1.1.15
      delivery-service "300"
    }
    security-policy {
      id 1
    }
  }
}

```

Example: Static LAN-to-LAN configuration using cert-auth (classic CLI)

```

A:node-2>config>service>vprn# info
-----
  interface "VPRN1" tunnel create
    sap tunnel-1.private:1 create
      ipsec-tunnel "Sanity-1" create
        security-policy 1
        local-gateway-address 10.1.1.13 peer 10.1.1.15 delivery-service 300
        dynamic-keying
          ike-policy 1
          pre-shared-key "Sanity-1"
          transform 1
          cert
            trust-anchor "R1-0"
            cert "M2cert.der"
            key "M2key.der"
          exit
        exit
      exit
    no shutdown
  exit
exit

```

```
exit
-----
```

2.6.7 Configuring local command authorization profiles

Profiles are used to deny or allow access to a hierarchical branch or specific commands.

The following example displays a local command authorization profile called "service-22" that is associated with a username "user1".

Example: MD-CLI

```
[ex:/configure system security aaa local-profiles]
A:admin@node-2# info
  profile "service-22" {
    default-action permit-all
    entry 1 {
      match "configure"
      action permit
    }
    entry 2 {
      match "configure service vprn <22>"
      action read-only
    }
    entry 3 {
      match "show"
    }
    entry 4 {
      match "exit"
    }
  }
```

```
[ex:/configure system security user-params local-user]
A:admin@node-2# info
  user "user1" {
    console {
      member ["service-22"]
    }
  }
```

Example: classic CLI

```
A:node-2>config>system>security# info
-----
...
  profile "service-22"
    default-action permit-all
    entry 1
      match "configure"
      action permit
    exit
    entry 2
      match "configure service vprn <22>"
      action read-only
    exit
    entry 3
      match "show"
    exit
    entry 4
```

```

        match "exit"
        exit
    exit
...

-----
A:node-2>config>system>security# info
-----
...
    user "user1"
        ...
        console
            member "service-22"
        exit
...

```

2.6.7.1 Matching on values in command authorization rules

In addition to matching on command keywords, command authorization profiles allow matching on the values of command elements.

Example: Matching on a command element value (MD-CLI)

```

configure system security aaa local-profiles profile "service-ops" entry 10 match
"configure service vprn <55>"

```

Example: Matching on a command element value (classic CLI)

```

configure system security profile "service-ops" entry 10 match "configure service vprn
<55>"

```

The following rules apply to matching on values:

- **Rule 1**
 - **MD-CLI**
For command authorization matching on commands that you enter in the MD-CLI, you can specify the match value with or without angle brackets (< >) around the command argument. If the match value is not in angle brackets, the match does not occur against that value when you enter the command in the classic CLI.
 - **classic CLI**
For command authorization matching on commands that you enter in the classic CLI, you must specify the match value in angle brackets in the **match** command argument, as shown in the [Matching on a command element value \(classic CLI\)](#) example.
- **Rule 2**
 - **MD-CLI**
Only the value of key leafs can be matched in a command authorization rule.
 - **classic CLI**
The value of any element can be matched in a command authorization rule.
- **Rule 3**

When a value in angle brackets is present in a **match** command argument, all key values to the left of the value must also be specified (in angle brackets). See [Using wildcards in command authorization value matching](#) for more information.

- **Rule 4**

You can either specifically state or completely omit a match value in the match string, as required. However, all unnamed parameters in the CLI command must be present in the match string when you use matching on a value. The following example shows how to match on OSPF to allow or deny access to all of OSPF.

```
match "configure router ospf" action deny
```

Alternatively, use the following command to allow a specific OSPF instance for a user.

```
match "configure router ospf <0> <10.10.10.1>" action permit
```

- **Rule 5**

To generate the correct match behavior when multiple unnamed parameters are present in the match string, you must provide the parameters in the correct order as described in the command help. For example, in the second match example shown in Rule 4, the OSPF instance (0) must come before the router ID (10.10.10.1).



Note: The match behavior may not be achieved if unnamed parameters are out of order in the **match** command. Although the user matching is based on the OSPF instance value, that is, "an unnamed value", all the other unnamed values in the **ospf** command (such as the router ID value) must also be present in the match string.

Example: Match value configuration (MD-CLI)

```
[ex:/configure system security aaa local-profiles profile "default"]
A:admin@node-2# info
  entry 10 {
    match "show router <22> route-table"
    action permit
  }
  entry 20 {
    match "configure service vprn <22>"
    action read-only
  }
  entry 30 {
    match "show service id <22>"
    action permit
  }
  entry 40 {
    match "configure router interface <system>"
    action deny
  }
}
```

Example: Match value configuration (classic CLI)

```
A:node-2>config>system>security>profile# info
  entry 10
    match "show router <22> route-table "
    action permit
  exit
  entry 20
```

```

        match "configure service vprn <22>"
        action read-only
    exit
    entry 30
        match "show service id <22>"
        action permit
    exit
    entry 40
        match "configure router interface <system>"
        action deny
    exit

```

2.6.7.2 Using wildcards in command authorization value matching



Note: The command authorization using wildcards is also supported against values you enter into the classic CLI engine only. However, you can configure the wildcard rules in the classic CLI or the MD-CLI.

In addition to matching on specific values in command authorization profiles (see [Matching on values in command authorization rules](#)), wildcard matching is supported for matching against values in the following commands, when these commands are executed in the classic CLI engine:

- **oam** commands
- **ping**
- **traceroute**
- **mtrace**

For example, use the following command for wildcard matching on a value `<.*>`.

```
match "oam ancp subscriber <.*> loopback"
```

Wildcard value matching is particularly useful when you want to match on a string that contains multiple values, but you only want a specific match on one of the values. The following example shows a command authorization profile with a list of all the permitted IP addresses for ping in router 10.

Example: Using a list of all the permitted IP addresses as match values

```

match ping <10.0.0.1> router <10>
action permit
match ping <10.0.0.2> router <10>
action permit

```

Alternatively, you can use wildcard value matching, which allows a simpler match criterion. In the following example, the use of the `<.*>` wildcard enables the ability to ping any address in the router 10 context, that is, any address in VRF 10.

Example: Using wildcards for IP address matching

```

match ping <.*> router <10>
action permit

```



Note: While wildcards are available and allowed for all command options in the OAM subtree, Nokia recommends that you exercise caution when using wildcards and limit their use to commands such as **ping**, **traceroute**, and **mtrace**. The use of wildcards in specific formats

may be a security concern and result in making the IP addresses in the VRF, including the base routing table, unreachable. Or it could allow the customer to ping any IP address in the VRF, including the base routing table. Avoid this because it is a potential security concern. The following usage, for example, is not advised.

Example: Wildcard usage to avoid

```
match ping <.*> router <.*>
action permit
```

2.6.7.3 CLI session resource management

SR OS has the capability to manage Telnet/SSH sessions per user and at a higher level per system. At the system level, the user can configure a CLI-session group for different customer priorities. The **cli-session-group** command is a container that sets the maximum number of CLI sessions for a class of customers, with a unique session limit for each customer. For example, as shown in [Figure 11: Classic CLI session groups for customer classes](#), "Gold" category customers can have a CLI-session group that allows them more Telnet/SSH sessions compared to "Silver" category customers.

Figure 10: MD-CLI session groups for customer classes

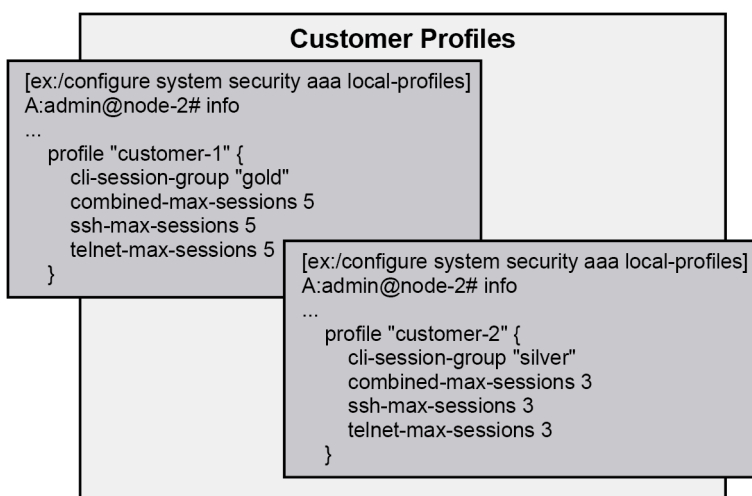

al_0777-2

Figure 11: Classic CLI session groups for customer classes

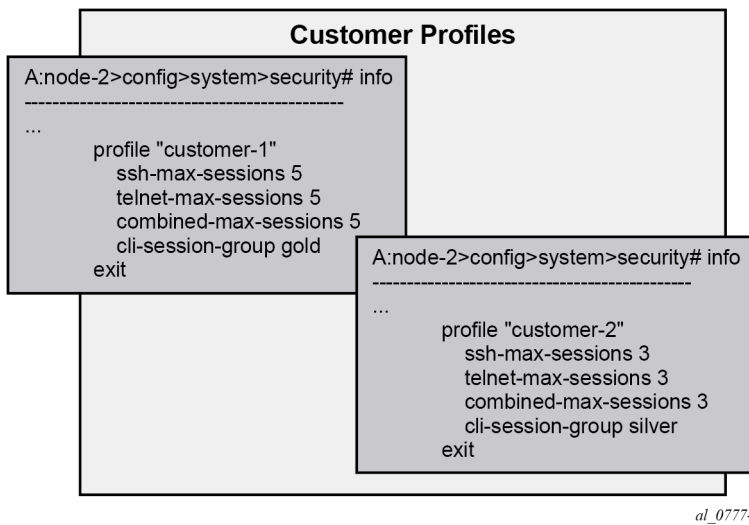

The configured **cli-session-group** can be assigned to user profiles. Each user profile can be configured with its own max SSH/Telnet session and is policed/restricted by the higher order **cli-session-group** that is assigned to it.

As shown in [Figure 13: Hierarchy of classic CLI session group profiles](#), the final picture is a hierarchical configuration with top-level cli-session-groups that control each customer's total number of SSH or Telnet sessions and the user-profile for each user for that customer.

Figure 12: Hierarchy of MD-CLI session group profiles

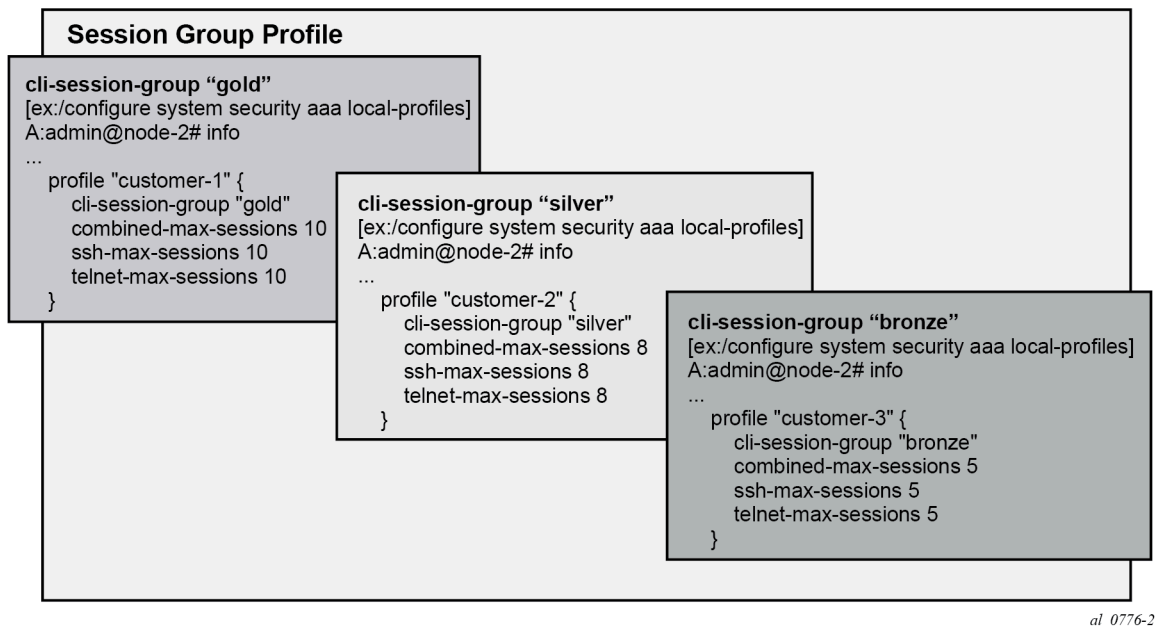
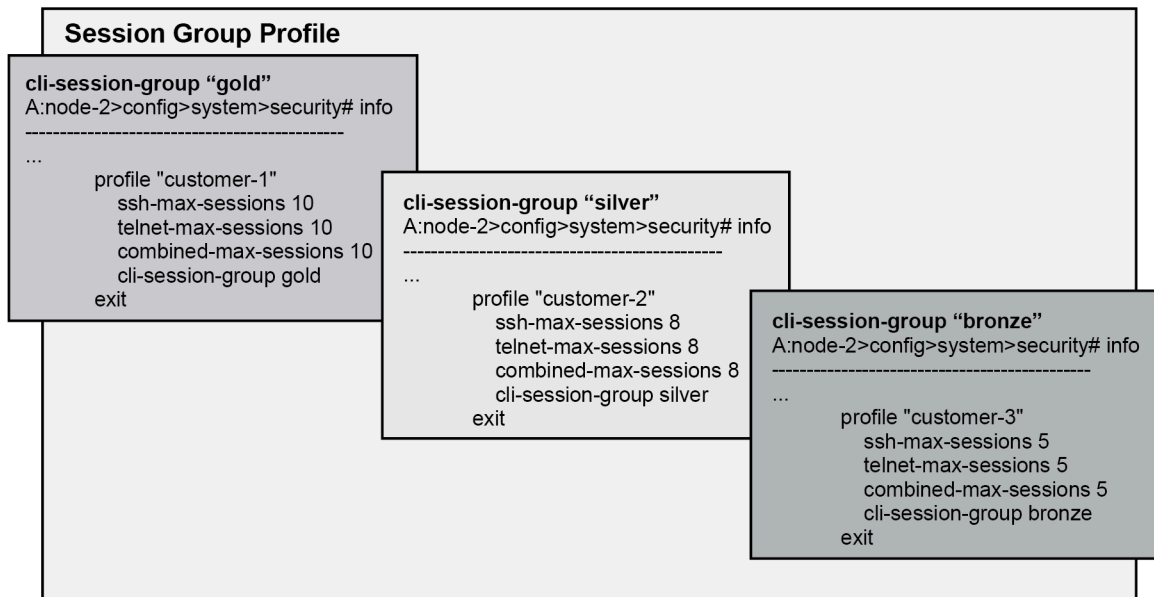

Figure 13: Hierarchy of classic CLI session group profiles



al_0776-1

Every profile subtracts one from its corresponding maximum session when a Telnet or SSH session is established in the following cases:

- where multiple profiles are configured under a user
- where multiple profiles arrive from different AAA servers (Local Profile, RADIUS Profile or TACACS Profile)

The first profile to run out of corresponding **max-session** limits future Telnet or SSH sessions. In other words, while each profile for the user can have its independent **max-session**, only the lowest one is honored. If the profile with the lowest **max-session** is removed, the next lower profile **max-session** is honored and so on. All profiles for a user are updated when a Telnet or SSH session is established.

For information about login control, see [Configuring login controls](#).

Use the commands **ssh-max-sessions**, **telnet-max-sessions**, **combined-max-sessions**, and **cli-session-group** in the following context to configure CLI session resources:

- **MD-CLI**

```
configure system security aaa local-profiles profile
```

- **classic CLI**

```
configure system security profile
```

2.6.8 Configuring local users

Configure access for individual local users. Include the user's login name and optionally include information that identifies the user.

Example: MD-CLI

```
[ex:/configure system security user-params local-user]
A:admin@node-2# info
  user "user1" {
    password "$2y$10$TQrZlpBDra86.qoexZUzQeBXDY1FcdDhGwdD9lLxMuFyPVSm00Gy6"
    restricted-to-home true
    save-when-restricted true
    access {
      console true
    }
    console {
      member ["default" ]
    }
  }
}
```

Example: classic CLI

```
A:node-2>config>system>security# info
-----
...
      user "user1"
        password "$2y$10$TQrZlpBDra86.qoexZUzQeBXDY1FcdDhGwdD9lLxMuFyPVSm00Gy6"
        access console
        restricted-to-home
        save-when-restricted
        console
          member "default"
        exit
      exit
...
-----
```

2.6.9 Configuring keychains

The following example shows a keychain configuration.

Example: MD-CLI

```
[ex:/configure system security keychains]
A:admin@node-2# info
  keychain "abc" {
    bidirectional {
      entry 1 {
        authentication-key "LHDhK3oGRvkiefQnx700c/yutg== hash2"
        algorithm aes-128-cmac-96
        begin-time 2006-12-18T22:55:20.0+00:00
      }
    }
  }
  keychain "basasd" {
    receive {
      entry 1 {
        authentication-key "LHDhK3oGRvkiefQnx700c3ib6A== hash2"
        algorithm aes-128-cmac-96
        tolerance infinite
      }
    }
  }
}
```



```

A:admin@node-2# info
...
}
user "user1" {
  password "$2y$10$TQrZlpBDra86.qoexZUzQeBXDY1FcdDhGwdD9LLxMuFyPVSm00Gy6"
  access {
    snmp true
  }
  console {
    cannot-change-password true
    member ["default"]
  }
  snmp {
    group "testgroup"
  }
}
user "user2" {
  password "$2y$10$TQrZlpBDra86.qoexZUzQeBXDY1FcdDhGwdD9LLxMuFyPVSm00Gy6"
  access {
    snmp true
  }
  console {
    new-password-at-login true
    member ["default"]
  }
  snmp {
    group "testgroup"
  }
}
...

```

Example: classic CLI

```

A:node-2>config>system>security>user# info
-----
user "user1"
password "$2y$10$TQrZlpBDra86.qoexZUzQeBXDY1FcdDhGwdD9LLxMuFyPVSm00Gy6"
access snmp
console
  cannot-change-password
exit
snmp
  group "testgroup"
exit
exit
-----
A:node-2>config>system>security>user# info
-----
user "user2" password "$2y$10$TQrZlpBDra86.qoexZUzQeBXDY1FcdDhGwdD9LLxMuFyPVSm00Gy6"
access snmp
console
  new-password-at-login
exit
snmp
  group "testgroup"
exit
exit
-----

```

2.6.10.2 Local user profiles

Use the **copy** and **to** commands to copy a local user profile to another local user profile.

- **MD-CLI**

```
configure system security aaa local-profiles
copy profile user-profile-name to profile user-profile-name
```

- **classic CLI**

```
configure system security copy profile user-profile-name to user-profile-name
```

2.6.11 RADIUS configurations

2.6.11.1 Configuring RADIUS authentication

RADIUS is disabled by default and must be explicitly enabled. The RADIUS server commands add the RADIUS server. The mandatory configurations to enable the RADIUS server on the local router include the server index, IP address, and secret key. The index determines the sequence in which the servers are queried for authentication requests. In addition, configure the port, and retry and timeout intervals. The other configuration aspects are optional.

The system IP address must also be configured for the RADIUS client to work. For more information, see the *7450 ESS, 7750 SR, 7950 XRS, and VSR Router Configuration Guide, "Configuring a System Interface"*.

Use the commands in the following context to enable the RADIUS server on the local router:

- **MD-CLI**

```
configure system security aaa remote-servers radius
```

- **classic CLI**

```
configure system security radius
```

Example: MD-CLI

```
[ex:/configure system security aaa remote-servers radius]
A:admin@node-2# info
server-retry 5
server-timeout 5
server 1 {
    address 10.10.10.103
    secret "G080mFGXGZjnMgeFRMlrNp80dc0s hash2"
}
server 2 {
    address 10.10.0.1
    secret "YDA64iuZiGG847KPM+7Bvuj3waIn hash2"
}
server 3 {
    address 10.10.0.2
    secret "/WGg0vT3fYcPwh4F5+gGe0Vvlfw1 hash2"
}
```

```
server 4 {
  address 10.10.0.3
  secret "p0Yk1obgPtJ2fAq9hcFEJp5tLxKa hash2"
}
```

Example: classic CLI

```
A:node-2>config>system>security# info
-----
      retry 5
      timeout 5
      server 1 address 10.10.10.103 secret "test1"
      server 2 address 10.10.0.1 secret "test2"
      server 3 address 10.10.0.2 secret "test3"
      server 4 address 10.10.0.3 secret "test4"
      ...
-----
```

2.6.11.2 Configuring RADIUS authorization

For RADIUS authorization to function, you must first enable RADIUS authentication. See [Configuring RADIUS authentication](#).

In addition to the local configuration requirements, configure VSAs on the RADIUS server. See [RADIUS VSAs](#).

Use the following command to configure RADIUS authorization on the local router:

- **MD-CLI**

```
configure system security aaa remote-servers radius authorization
```

- **classic CLI**

```
configure system security radius authorization
```

2.6.11.3 Configuring RADIUS accounting

Use the following CLI command to configure RADIUS accounting on the local router:

- **MD-CLI**

```
configure system security aaa remote-servers radius accounting
```

- **classic CLI**

```
configure system security radius accounting
```

2.6.12 Configuring 802.1x RADIUS policies

Use the commands in the following context to configure generic authentication for clients using 802.1x EAPOL. Additional options are configured per Ethernet port. For more information, see the *7450 ESS*, *7750 SR*, *7950 XRS*, and *VSR Interface Configuration Guide*.

- **MD-CLI**

```
configure system security dot1x radius-policy
```

- **classic CLI**

```
configure system security dot1x radius-plcy
```

The following example shows an 802.1x configuration.

Example: MD-CLI

```
[ex:/configure system security dot1x radius-policy "dot1x_plcy"]
A:admin@node-2# info
  admin-state enable
  source-address 10.1.1.255
  server 1 {
    address 10.1.1.1
    secret "ypeBESobvcr6wjGzmiPcTfM= hash2"
    authentication-port 65535
  }
  server 2 {
    address 10.1.1.2
    secret "ypeBESobvcr6wjGzmiPcTXk= hash2"
    authentication-port 65535
  }
}
```

Example: classic CLI

```
A:node-2>config>system>security# info
-----
      dot1x
        radius-plcy "dot1x_plcy" create
          server 1 address 10.1.1.1 port 65535 secret "a"
          server 2 address 10.1.1.2 port 65535 secret "a"
          source-address 10.1.1.255
          no shutdown
        ...
-----
```

2.6.13 TACACS+ configurations

2.6.13.1 Enabling TACACS+ servers with authentication

You can use TACACS+ authentication on the router. Use the commands in the following context to configure one or more TACACS+ servers on the network:

- **MD-CLI**

```
configure system security aaa remote-servers tacplus server
```

- **classic CLI**

```
configure system security tacplus server
```

The following example shows a TACACS+ configuration with authentication.

Example: MD-CLI

```
[ex:/configure system security aaa remote-servers tacplus]
A:admin@node-2# info
  server-timeout 5
  server 1 {
    address 10.10.0.5
    secret "G080mFGXGZjnMgeFRmlrNn1Ak0Vj hash2"
  }
  server 2 {
    address 10.10.0.6
    secret "YDA64iuZiGG847KPM+7BvsC4f/EL hash2"

  server 3 {
    address 10.10.0.7
    secret "/WGg0vT3fYcPwh4F5+gGeBToxeh5 hash2"
  }
  server 4 {
    address 10.10.0.8
    secret "p0Yk1obgPtJ2fAq9hcFEJtCZ/Qj/ hash2"
  }
  server 5 {
    address 10.10.0.9
    secret "oUDAwe2i3vK4MDY7o2KqTdr3cfHp hash2"
  }
```

Example: classic CLI

```
A:node-2>config>system>security>tacplus# info
-----
  timeout 5
  server 1 address 10.10.0.5 secret "test1"
  server 2 address 10.10.0.6 secret "test2"
  server 3 address 10.10.0.7 secret "test3"
  server 4 address 10.10.0.8 secret "test4"
  server 5 address 10.10.0.9 secret "test5"
-----
```

2.6.13.2 Configuring TACACS+ authorization

For TACACS+ authorization to function, you must first enable TACACS+ authentication. See [Enabling TACACS+ servers with authentication](#).

Use the command in the following context to configure TACACS+ authorization on the local router:

- **MD-CLI**

```
configure system security aaa remote-servers tacplus authorization
```

- **classic CLI**

```
configure system security tacplus authorization
```

2.6.13.3 Configuring TACACS+ accounting

Use the following command to configure TACACS+ accounting on the local router:

- **MD-CLI**

```
configure system security aaa remote-servers tacplus accounting
```

- **classic CLI**

```
configure system security tacplus accounting
```

2.6.14 LDAP configurations

2.6.14.1 Configuring LDAP authentication

LDAP is disabled by default and must be explicitly enabled. To use LDAP authentication on the router:

- Configure one or more LDAP servers on the network.
- Ensure that TLS certificates and clients are also configured; see [TLS](#) for information about TLS configuration in the SR OS.

Use the commands in the following context to configure LDAP:

- **MD-CLI**

```
configure system security aaa remote-servers ldap
```

- **classic CLI**

```
configure system security ldap
```

The following example shows the LDAP authentication configuration. See [LDAP authentication](#) for more information about the use of LDAP authentication in the SR OS.

Example: MD-CLI

```
[ex:/configure system security aaa remote-servers ldap]
A:admin@node-2# info
  admin-state enable
  public-key-authentication true
  server 1 {
    admin-state enable
    server-name "active-server"
    tls-profile "server-1-profile"
    address 10.1.1.1 {
    }
    bind-authentication {
      root-dn "cn=administrator,cn=users,dc=nacblr2,dc=example,dc=com password"
    }
    search {
      base-dn "dc=sns,dc=example,dc=com"
    }
  }
[ex:/configure system security tls]
A:admin@node-2# info
```

```

client-tls-profile "server-1-profile" {
    admin-state enable
    cipher-list "to-active-server"
    trust-anchor-profile "server-1-ca"
}

```

Example: classic CLI

```

A:node-2>config>system>security>ldap# info
-----
public-key-authentication
server 1 create
    address 10.1.1.1
    bind-authentication "cn=administrator,cn=users,dc=nacblr2,dc=example,dc=com
        password"
    ldap-server "active-server"
    search "dc=sns,dc=example,dc=com"
    tls-profile "server-1-profile"
    no shutdown
exit
no shutdown
-----
A:node-2>config>system>security>tls# info
-----
client-tls-profile "server-1-profile" create
    cipher-list "to-active-server"
    trust-anchor-profile "server-1-ca"
no shutdown
exit

```

2.6.14.2 Configuring redundant servers

You can configure up to five redundant LDAP servers. The following examples show configuration of two servers. Server 1 is active and server 5 is backup.

Example: Active server configuration (MD-CLI)

```

[ex:/configure system security aaa remote-servers ldap]
A:admin@node-2# info
public-key-authentication true
server 1 {
    server-name "active-server"
    tls-profile "server-1-profile"
    address 10.1.1.1 {
    }
}
[ex:/configure system security tls]
A:admin@node-2# info
client-tls-profile "server-1-profile" {
    admin-state enable
    cert-profile "client-cert-profile"
    cipher-list "to-active-server"
    trust-anchor-profile "server-1-ca"
}

```

Example: Backup server configuration (MD-CLI)

```

[ex:/configure system security aaa remote-servers ldap]
A:admin@node-2# info

```

```

public-key-authentication true
server 5 {
  server-name "backup-server-5"
  tls-profile "server-5-profile"
  address 10.5.5.1 {
  }
}
[ex:/configure system security tls]
A:admin@node-2# info
  client-tls-profile "server-5-profile" {
    admin-state enable
    cert-profile "client-cert-profile"
    cipher-list "to-backup-server 5"
    trust-anchor-profile "server-5-ca"
  }
}

```

Example: Active server configuration (classic CLI)

```

A:node-2>config>system>security>ldap# info
public-key-authentication
server 1 create
address 10.1.1.1
ldap-server "active-server"
tls-profile "server-1-profile"

A:node-2>config>system>security>tls# info
client-tls-profile "server-1-profile" create
cert-profile "client-cert-profile"
cipher-list "to-active-server"
trust-anchor-profile "server-1-ca"
no shutdown
exit

```

Example: Backup server configuration (classic CLI)

```

A:node-2>config>system>security>ldap# info
public-key-authentication
server 5 create
address 10.5.5.1
ldap-server "backup-server-5"
tls-profile "server-5-profile"

A:node-2>config>system>security>tls# info
client-tls-profile "server-5-profile" create
cert-profile "client-cert-profile"
cipher-list "to-backup-server-5"
trust-anchor-profile "server-5-ca"
no shutdown
exit

```

2.6.14.3 Configuring login controls

Configure login control for console, Telnet, and FTP sessions. The following example shows a login control configuration.

Example: MD-CLI

```

[ex:/configure system]
A:admin@node-2# info

```

```
login-control {
  exponential-backoff false
  idle-timeout 1440
  motd {
    text "Notice to all users: Software upgrade scheduled 3/2 1:00 AM"
  }
  pre-login-message {
    message "Property of Service Routing Inc. Unauthorized access prohibited."
  }
  ftp {
    inbound-max-sessions 5
  }
  telnet {
    inbound-max-sessions 7
    outbound-max-sessions 2
  }
}
```

Example: classic CLI

```
A:node-2>config>system# info
-----
...
  login-control
    ftp
      inbound-max-sessions 5
    exit
    telnet
      inbound-max-sessions 7
      outbound-max-sessions 2
    exit
    idle-timeout 1440
    pre-login-message "Property of Service Routing Inc. Unauthorized access
      prohibited."
    motd text "Notice to all users: Software upgrade scheduled 3/2 1:00 AM"
  exit
no exponential-backoff
...
-----
```

3 Model-driven management interfaces

SR OS supports two classes of management interfaces:

- Classic management interfaces
 - SNMP
 - classic CLI
- Model-driven management interfaces
 - Model-Driven CLI (MD-CLI)
 - NETCONF
 - gRPC (gNMI and gNOI)

Unless otherwise indicated, the term "CLI" in the SR OS user documentation refers to the classic CLI. The classic CLI has been supported in SR OS from the initial introduction of SR OS. For more information about classic CLI commands, see the *7450 ESS, 7750 SR, 7950 XRS, and VSR Classic CLI Command Reference Guide*.

The MD-CLI is a model-driven CLI introduced in SR OS Release 16.0.R1. For more information about MD-CLI commands, see the *7450 ESS, 7750 SR, 7950 XRS, and VSR MD-CLI User Guide* and the *7450 ESS, 7750 SR, 7950 XRS, and VSR MD-CLI Command Reference Guide*.

Model-driven management interfaces are based on a common infrastructure that uses YANG models as the core definition for configuration, state, and operational actions. All model-driven interfaces take the same common underlying YANG modules and render them for the particular management interface.

The model-driven interfaces are similar to the classic CLI interfaces with the following notable differences.

- The classic and model-driven configuration formats are incompatible; the system automatically converts the classic configuration to the model-driven format when the management interface configuration mode is changed to **model-driven**.
- Some classic CLI branches have been moved, renamed, or reorganized in the SR OS YANG modules.
- Many elements use strict references in model-driven interfaces instead of the loose references used in the classic CLI and SNMP. For more information, see [Loose references to IDs](#) and [Strict routing policy validation](#).
- Many elements use string names as keys in model-driven interfaces instead of the numerical identifiers used in the classic CLI and SNMP. See [String names as keys](#) for more information.
- The classic CLI **shutdown** command has been replaced with **admin-state** in model-driven interfaces.
- The classic CLI commands with multiple parameters have been separated into individual leaves in model-driven interfaces.
- The model-driven interfaces make extensive use of Boolean values (true and false) for configuration settings.
- The default configuration handling is as follows.
 - In model-driven configuration mode, the system operates with "explicit" default handling. Users can set a leaf to the same value as the default and the system displays it as part of the configuration. This handling is similar to RFC 6243 "explicit" mode.

- In mixed configuration mode, the system uses “explicit” default handling but it is not persistent. Explicitly configured default values are not preserved during a high-availability CPM switchover or a reboot. Nokia recommends deleting the leaf instead of setting any leaf explicitly to its default value in mixed configuration mode.
- A newly created routing instance, group, or EBGp neighbor in a model-driven interface applies the secure default behavior to reject all routes. Using the **ebgp-default-reject-policy** command to implement this is compliant with RFC 8212. Nokia recommends configuring import and export policies that express the intended routing instead of using the insecure default behavior. For more information about RFC behavior, see the *7450 ESS, 7750 SR, 7950 XRS, and VSR Unicast Routing Protocols Guide*.

3.1 Management interface configuration modes

The system can operate in different management interface configuration modes, which affects which CLI and network management protocols can be used to configure the system. The following interfaces are available for configuration on SR OS:

- **model-driven (default)**
Configuration via model-driven interfaces: the MD-CLI, NETCONF, and gRPC/gNMI, read-only access via the classic CLI and SNMP.
- **classic**
Configuration via the classic CLI and SNMP, no model-driven interfaces are supported.
- **mixed**
Configuration via the classic CLI and model-driven interfaces: the MD-CLI, NETCONF, and gRPC/gNMI, read-only access via SNMP.

Mixed configuration mode is a transition mode for operators to migrate from classic management interfaces to operating in a full model-driven mode. It allows the use of previous classic CLI scripts or other OSS integration developed by users for configuration, although with some prerequisites (see [Prerequisites for using model-driven management interfaces with classic configurations](#)) and some limitations (see [Table 21: Management interface configuration mode](#)).

Use the **configure system management-interface configuration-mode** command to enable configuration editing by model-driven interfaces.

Table 21: Management interface configuration mode

| | | Configuration mode | | |
|--------------------|---|--------------------|-------|--------------|
| | | Classic | Mixed | Model-driven |
| Classic Interfaces | Classic CLI: configuration write | ✓ | ✓ | |
| | Classic CLI: configuration read | ✓ | ✓ | ✓ |
| | Classic CLI: non-configuration commands | ✓ | ✓ | ✓ |
| | SNMP: configuration write | ✓ | | |

| | | Configuration mode | | |
|--|---|--------------------|---------|--------------|
| | | Classic | Mixed | Model-driven |
| | SNMP: non-configuration writes (such as admin reboot) | ✓ | | |
| | SNMP: configuration read | ✓ | ✓ | ✓ |
| | SNMP: state read | ✓ | ✓ | ✓ |
| | SNMP: notifications (traps) | ✓ | ✓ | ✓ |
| Model-driven Interfaces with Nokia YANG Models | MD-CLI: configuration write and read | | ✓ | ✓ |
| | MD-CLI: state read | ✓ | ✓ | ✓ |
| | NETCONF: configuration write and read | | ✓ | ✓ |
| | NETCONF: state read | ✓ | ✓ | ✓ |
| | gNMI Set/Get: configuration write and read | | ✓ | ✓ |
| | gNMI Get: state read | ✓ | ✓ | ✓ |
| | gNMI Telemetry: configuration read | | ✓ | ✓ |
| | gNMI Telemetry: state read | ✓ | ✓ | ✓ |
| Saved Configuration File Format | bof | Classic | Classic | Classic |
| | configure | Classic | Classic | MD |
| | debug | Classic | Classic | MD |
| | li | Classic | Classic | MD |
| Features | OpenConfig YANG models | | | ✓ |
| | Commit history | | | ✓ |
| | Configuration annotations | | | ✓ |
| | Configuration groups | | | ✓ |
| | MD-CLI rollback command | | | ✓ |
| | Classic CLI admin rollback revert command | ✓ | ✓ | |
| | Explicit defaults ⁴ | | | ✓ |

⁴ In model-driven mode, users can set a parameter to the same value as the default, and SR OS remembers that it was explicitly set and displays it as part of the configuration. In mixed mode, these values are not persistent and they are lost or forgotten at a CPM high-availability switchover or a reboot.

| | | Configuration mode | | |
|--|--|--------------------|-------|--------------|
| | | Classic | Mixed | Model-driven |
| | Explicit non-deletable SPC objects ⁵ | | | ✓ |
| | Configuration changes accepted immediately after a CPM high-availability switchover ⁶ | ✓ | | ✓ |
| | Named route policy entries | | | ✓ |
| | gRPC MD-CLI service for the NISH client | | ✓ | ✓ |
| | Remote management using the NISH manager | | ✓ | ✓ |
| | MD-CLI command aliases | | | ✓ |
| | Python 3 for pyexec , EHS, CRON, and MD-CLI command aliases | | | ✓ |
| | The use of the pySROS library from any location | | | ✓ |
| | Incremental saved configuration files | | | ✓ |

3.2 YANG data models

Model-driven management interfaces are based on a common infrastructure that uses YANG models as the core definition for configuration, state, and operational actions. All model-driven interfaces (NETCONF, gRPC/gNMI, and the MD-CLI) use the same common underlying YANG modules and render them for the particular management interface. These YANG models are also used for telemetry.

SR OS supports:

- Nokia YANG data models
- OpenConfig YANG data models

3.2.1 Nokia SR OS YANG data models

The Nokia SR OS YANG modules are the base for the model-driven architecture.

⁵ In model-driven mode, users can explicitly create any of the SR OS non-deletable SPC objects, and SR OS remembers that it was explicitly created and displays it as part of the configuration. See [SPC objects](#), for more details about the SPC objects.

⁶ In mixed mode, changes to the configuration are blocked for a few minutes after a CPM high-availability switchover event while the model-driven database is synchronized with the SR OS application layer. There is no impact to running services.

SR OS configuration is divided into several top level configuration regions (see [Datastores and regions](#) for details). The data models for each configuration region are separated into different YANG modules.

The primary configuration region (**configure**) is modeled in the nokia-conf YANG module specified in a single file located at YANG/nokia-combined/nokia-conf.yang in the SR OS image distribution.

An alternative packaging of the primary configuration region is also available as a set of submodules (for example, nokia-conf-system) that belong to a single module located at YANG/nokia-conf.yang in the SR OS image distribution. The submodules have independent revision dates and can be used to identify which parts of the configuration model have changed.

The packaging options (combined and submodule) are alternate representations of the same data model. There is no difference between using the combined or submodule packaging for all the basic configuration or state operations (including with telemetry). The same containers, list, leafs, and so on, exist in the same namespaces whether you are using the combined or submodule packaging. The main difference between the combined and submodule options is seen in the NETCONF <hello>, YANG library, and <get-schema> data where there are lists of modules and submodules.

Some YANG tools may show errors about circular dependencies in the submodules. For example, Pyang gives an error about circular dependencies but does complete the processing to build complete tree or jstree output. If circular dependencies are preventing any necessary tools from correctly processing the YANG, use the combined packaging instead of the submodules. For details about enabling various sets of YANG modules, see the **yang-modules** commands in the *7450 ESS, 7750 SR, 7950 XRS, and VSR Classic CLI Command Reference Guide*.

The lawful intercept (LI) configuration region is modeled in the nokia-li-conf YANG module specified in a single file called nokia-li-conf.yang.

The BOF configuration region is modeled in the nokia-bof-conf YANG module specified in a single file called nokia-bof-conf.yang.

SR OS state information is modeled in the nokia-state YANG module specified in a single file located at YANG/nokia-combined/nokia-state.yang in the SR OS image distribution.

LI state information is modeled in nokia-li-state.yang which augments the primary nokia-state module.

BOF state information is modeled in nokia-bof-state.yang.

There are also a series of nokia-types-* modules that are included by various configuration and state modules.

The SR OS YANG modules have the following attributes.

- The modules can be used with NETCONF, telemetry, or with the Set/Get RPCs of the gRPC-based gNMI service.
- The modules and submodules indicate the SR OS major release stream using a YANG extension (for example, sros-ext:sros-major-release "rel16");. Module and submodule revisions form a contiguous series of revisions inside a major release stream. There may be two files for the same module with the same revision date but with different contents because they are from two different major release streams. Each active major release stream has revisions ongoing in parallel.

All configuration modules, state modules, and types modules are advertised in the SR OS NETCONF server <hello>. Submodules are not advertised in the <hello>.

The common operational **clear**, **monitor**, **show**, and **tools** CLI commands do not have equivalent YANG data models.

Some **admin** and **file** operations have YANG models whereby each operation is modeled using a YANG "action" statement. These can be viewed in the nokia-oper-*.yang files. See [YANG-modeled operations](#) for more information.

3.2.2 OpenConfig YANG data models

Nokia provides a suite of vendor-specific YANG models to configure the network element. OpenConfig is an informal working group which provides vendor-neutral YANG models based on the needed usage of a technology by the community. The Nokia vendor-specific model is a more complete representation of the capabilities of the network element, which includes vendor specific features and functions not described by the OpenConfig YANG models. The two YANG configuration models, Nokia's vendor-specific and OpenConfig's vendor-neutral, may be used together to configure the network element. Support for OpenConfig models can be established by examining the OpenConfig model with the vendor-specific deviations and augments.

3.2.2.1 Basic configuration

OpenConfig YANG models are available in model-driven interfaces, including the MD-CLI, gNMI, and NETCONF. Use the following command to enable OpenConfig YANG models.

```
configure system management-interface yang-modules openconfig-modules
```

Access to the OpenConfig models is different depending on the model-driven interface.

- **MD-CLI**

- OpenConfig configuration statements are located in the **configure openconfig** context.
- OpenConfig state information is located in the **state openconfig** context.
- When a configuration is validated or committed, the system verifies that **openconfig-modules** is set to **true**. If **openconfig-modules** is set to **false** and there are OpenConfig configuration statements in the candidate, the action fails with an error indicating that the OpenConfig module cannot be disabled when OpenConfig configuration elements exist.

The operator must set **openconfig-modules** to **true** and perform the **validate** or **commit** action again.

- The system checks **openconfig-modules** to determine whether OpenConfig state elements can be accessed.

- **gNMI and NETCONF**

- The system checks **openconfig-modules** to determine whether OpenConfig models can be advertised and whether the system can accept or send OpenConfig configuration or state elements.
- If **openconfig-modules** is set to **false**, the system blocks OpenConfig edits, requests, and responses from being sent or accepted at the gNMI or NETCONF level. A <get> operation from the root without a declared namespace or branch succeeds but does not include any OpenConfig data. However, a <get> operation that explicitly requests data from the OpenConfig namespace generates an error.

- **AAA rules for OpenConfig are different in the MD-CLI, NETCONF and gNMI**

- A **configure openconfig** AAA profile entry applies to **configure openconfig** commands in the MD-CLI, and to config and state elements in NETCONF and gNMI.
- A **state openconfig** AAA profile entry only applies to **state openconfig** information in the MD-CLI. AAA entries for NETCONF and gNMI state elements are not supported.

3.2.2.2 OpenConfig state without OpenConfig configuration

This feature supports the ability to retrieve the application state for the OpenConfig state path, without entries being configured in the OpenConfig models. This is helpful for users who only want to use a vendor-specific configuration to configure the node, but still want access to the OpenConfig common state information.

As part of the new feature, users can access OpenConfig state information from any of the following configuration mode settings.

```
configure system management-interface configuration-mode {classic | mixed | model-driven}
```

This means that regardless of the configuration mode, OpenConfig state information is available through any of the following:

- NETCONF using get commands
- Telemetry gRPC (on_change and polling) using the following command

```
tools dump system telemetry on-change-paths {open-config | nokia}
```

- MD-CLI using the **state openconfig** context

Use the following commands with a Layer 3 interface to enable access to the OpenConfig state information from any configuration mode without OpenConfig configuration.

```
configure router interface external-reference openconfig subinterface
configure service vprn interface external-reference openconfig subinterface
```

The addition of the external reference does not influence the configuration other than to allow for a mapping between the Nokia vendor-specific configuration and the OpenConfig state. As part of the configuration, a user must also configure a port for the interface and a Layer 3 subinterface.

Example: MD-CLI

```
[ex:/configure router "Base" interface "to-dutb"]
A:admin@node-2# info
  admin-state enable
  description "interface to dut b"
  external-reference
    openconfig
      subinterface 10
    }
  }
  port 1/1/c2/1:0
  ipv4 {
    primary {
      address 10.10.12.1
      prefix-length 24
    }
  }
  ipv6 {
    address 2001:db8:1:ab::a {
      prefix-length 64
    }
  }
}
```

Example: classic CLI

```
A:node-2>config>router# info
#-----
echo "IP Configuration"
#-----
...
    interface "to-dutb"
        external-reference
        openconfig
            subinterface 10
                exit
            exit
        address 10.10.12.1/24
        description "interface to dut b"
        port 1/1/c2/1:0
        ipv6
            address 2001:db8:1:ab::a/64
        exit
        no shutdown
    exit
-----
```

3.2.3 Shared model management

To ensure complete traceability of the origin of the configuration (that is, which data model configured the command), the Nokia and OpenConfig configuration trees maintain separate configuration statements. This allows for the greatest flexibility when accommodating configuration differences between the Nokia and OpenConfig models. If a conflict occurs during a merge (because of different values set in the two data models), the Nokia model has precedence.

To merge configuration for objects, the keys for an object must be equal and deterministic for both the Nokia and OpenConfig models. This provides an anchor for the object and allows the configuration to be rationalized and merged. For example, augments may have been made to OpenConfig models to allow for a deterministic key where a key function is not supported.

One example is using the following command to configure the primary address. In this case, the OpenConfig model does not define which of the specified interfaces should be the primary. The control of the primary interface is very important.

```
configure openconfig interfaces interface subinterfaces subinterface ipv4 config primary-
address
```

When configuration statements are completed using one configuration model, tab completion for a name or reference identifier is not available in the other model. For example, the name or identifier of a list entry must be equally and explicitly entered in both data models to share the configuration elements across the different models.

Two different approaches are taken for shared model management, on a per Nokia application basis, to managed lists and leaves.

An application that supports shared model management at the leaf level allows both configuration models access to the leaf and merge operations can occur at the leaf level. If both OpenConfig and Nokia models include configuration for a leaf, the Nokia configuration takes precedence. The OpenConfig configuration statements remain in the configuration but are not applied as part of the running configuration.

An application that supports shared model management at the list level allows only one model to manage individual list entries. The configuration model that creates the list entry is the only model that can modify or delete the list entry. An attempt to modify the list entry using the configuration access method that does not manage the list entry returns an error message identifying the managing owner of the list entry.

```
Cannot access or modify element - managed by <managing owner> module
```

Unless configured explicitly using the Nokia configuration model, a configuration element that does not have a static default value is managed by OpenConfig.

In some situations, partial or incomplete OpenConfig configurations may be allowed. For example, where the OpenConfig structure is accepted but the triggering mapping has not been configured under OpenConfig, the information is not delivered to the application. These partial configurations remain in the OpenConfig configuration tree as they are syntactically correct, however, without an application mapping event, they remain outside of the operating configuration. When a partial configuration is stored in the OpenConfig configuration tree, it does not show as an active element under the SR OS specific application, that is, via **show** commands or in the **state** tree.

To disable shared model management so that only one model is used to configure the same element, use the following command:

```
configure system management-interface yang-modules shared-model-management false.
```

For example, disable shared model management if OpenConfig configuration is used for all elements available in the OpenConfig models and you want to prevent the same configuration with Nokia models. When shared model management is disabled, the first model used to configure an element owns management of the element, and other models cannot configure it.

3.2.3.1 Application support

Applications allow for the configuration to be delivered from either the Nokia YANG model or the OpenConfig YANG models. In most cases, applications allow shared configuration such that the configuration statements can be received from both Nokia YANG models and OpenConfig YANG models. To determine the level of shared configuration an application allows, check the application-specific Nokia or the nokia-conf-combined.yang YANG models for the following extension statement.

Example

```
sros-ext:shared-model-management {
  sros-ext:openconfig false;
}
```

If the above statement is found, the shared model management configuration is not allowed for that element and all descendants of the element.

The level of shared model management support can be viewed via the MD-CLI help if the OpenConfig YANG models are enabled.

Example

```
[ex:configure system management-interface yang-modules]
A:admin@node-2# openconfig-modules true
```

The models that prevent shared model management at a specific level of the hierarchy include the following statement in the help output. For example, the commands in the **configure policy-options policy-statement** context display the following note:

Example

```
[ex:/configure policy-options policy-statement "policy-1"]
A:admin@node-2# entry ?

[entry-id] <number>
<number> - <1..4294967295>

Entry ID for a route policy entry

Note: 'configure policy-options policy-statement "policy-1"' and all other elements
in this context must be managed by one data model.
```

3.2.3.2 Validating and committing a configuration

Validation ensures the structure and completeness of the configuration against the OpenConfig model. It does not deliver the configuration to application. It is possible that a validation succeeds when the structure and requirements of the OpenConfig model are met.

The commit function performs the validation as above, with the additional step of delivering the converted OpenConfig statements to the application. A successful validation can be followed by a failure to commit the transaction. For example, the following scenarios result in a failed commit action:

- the Nokia application requirements are not met
- the list entry is managed by Nokia
- a resource limit enforced by the application is exceeded by merging the OpenConfig configuration

Nokia applications that include conditional “when” statements using the Nokia YANG model must have the statements satisfied by the Nokia configuration. The OpenConfig configuration cannot verify or satisfy Nokia conditional “when” statements. This approach prevents “when” statements from changing from one state to another by updating the OpenConfig statements and affecting a non-child leaf in the Nokia configuration. For example, the following message is displayed when the OpenConfig configuration sets the port Ethernet mode to hybrid but the conditional “when” statement requires the Nokia configuration to satisfy the condition.

```
MINOR: MGMT_CORE #2205: configure port 1/1/4 ethernet access - OpenConfig and Nokia condition mismatch - failed condition
```

Errors can occur in situations such as the following:

- the OpenConfig model attempts to deliver an incomplete configuration as required by the Nokia application
- conflicts exist where an OpenConfig model attempts to access a list entry managed by Nokia
- other delivery errors from the commit operation

Failed transactions display an error message indicating the reason for the failure. A failure maintains the complete set of YANG parameters, as if the commit function had not been issued. This allows the administrator to correct the source of the error.

In the event of a delivery error, the OpenConfig path and the Nokia path are included in the error message. The following example shows the structure of such an error message.

```
<severity>:<module> #<code>: <context in which the error occurred> <related context>
- <error message>
```

3.2.3.3 Displaying the configuration

Several variations of the **info** command are available to display the configuration in output formats that show Nokia and converted third-party model configuration in different ways. The following examples show syslog server 10.1.1.2 that is managed by both OpenConfig and Nokia models with some leafs managed by either Nokia, OpenConfig, or both models. Syslog server 192.168.0.10 is managed entirely by the OpenConfig model.

Example: info command

The following example shows the configuration starting at the present working context as in each model's native configuration syntax.

```
[ex:/configure openconfig system logging]
A:admin@node-2# info
  remote-servers {
    remote-server 10.1.1.2 {
      config {
        host 10.1.1.2
        source-address 10.1.1.2
        remote-port 456
      }
    }
    remote-server 192.168.0.10 {
      config {
        host 192.168.0.10
        source-address 192.168.0.10
        remote-port 456
      }
    }
  }

[ex:/configure log]
A:admin@node-2# info syslog *
  syslog "oc_rem_1.1.1.2" {
    address 1.1.1.2
    severity emergency
    port 540
  }
```

Example: info converted command

The following example shows converted third-party model configuration from the running datastore with model management displayed as a comment above each configuration element:

- **## managed: nokia** if the element is only managed by a Nokia model
- **## managed: openconfig** if the element is only managed by an OpenConfig model
- **## managed: openconfig-nokia** if the element is managed by both OpenConfig and Nokia models

Use this command to determine if two models are managing the same element, or if a model is managing an element that it is not intended to.

```
[ex:/configure log]
A:admin@node-2# info converted syslog *
## managed: openconfig-nokia
syslog "oc_rem_10.1.1.2" {
  ## managed: openconfig-nokia
  address 10.1.1.2
  ## managed: nokia
  severity emergency
  ## managed: openconfig
  log-prefix "10.1.1.2"
  ## managed: openconfig-nokia
  port 540
}
## managed: openconfig
syslog "oc_rem_192.168.0.10" {
  ## managed: openconfig
  address 192.168.0.10
  ## managed: openconfig
  log-prefix "192.168.0.10"
  ## managed: openconfig
  port 456
}
```

Example: info converted model openconfig command

The following example shows converted OpenConfig model configuration from the running datastore with the `## managed:` comment removed from the output. Use this command to show OpenConfig configuration in the Nokia format.

```
[ex:/configure log]
A:admin@cses-V93# info converted model openconfig syslog *
syslog "oc_rem_10.1.1.2" {
  log-prefix "10.1.1.2"
}
syslog "oc_rem_192.168.0.10" {
  address 192.168.0.10
  log-prefix "192.168.0.10"
  port 456
}
```

Example: info converted values command

The following example shows converted third-party model configuration from the running datastore with all the values that each model tries to set. Use this command to determine if there are duplicate or different configuration commands in the Nokia and third-party models. The configuration set by the third-party model is prefixed with `##` to indicate that the Nokia configuration has precedence and its value is in the running configuration. In the example below, both the Nokia and OpenConfig model set the address to 10.1.1.2, which is duplicate configuration. Both the Nokia and OpenConfig model set the port to different values, and the value 540 set by the Nokia model is in the running configuration.

```
[ex:/configure log]
A:admin@cses-V93# info converted full-context values syslog
## managed: openconfig
## /configure log syslog "oc_rem_10.1.1.2" { address 10.1.1.2 }
## managed: nokia
/configure log syslog "oc_rem_10.1.1.2" { address 10.1.1.2 }
## managed: openconfig
```

```
## /configure log syslog "oc_rem_10.1.1.2" { port 456 }
## managed: nokia
/configure log syslog "oc_rem_10.1.1.2" { port 540 }
```

Example: info converted differences command

The following example shows converted third-party model configuration from the running datastore with only the values that are different that each model tries to set. Use this command to determine if there are different configuration values in the Nokia and third-party models. The configuration set by the third-party model is prefixed with `##` to indicate that the Nokia configuration has precedence and its value is in the running configuration. In the following example, both the Nokia and OpenConfig model set the port to different values, and the value of 540 set by the Nokia model is in the running configuration.

```
[ex:/configure log]
A:admin@cses-V93# info converted full-context differences syslog
## managed: openconfig
## /configure log syslog "oc_rem_10.1.1.2" { port 456 }
## managed: nokia
/configure log syslog "oc_rem_10.1.1.2" { port 540 }
```

For more information about the **info** command, see the *7450 ESS, 7750 SR, 7950 XRS, and VSR MD-CLI User Guide*.

3.2.3.4 Deviations and augments

Deviation files are created for the OpenConfig model when the model deviates from the application requirements of the system, such as implementations that are not supported, added, or replaced, granularity mismatches, and different ranges. These deviations are included in an OpenConfig YANG file, which contains text descriptions when different units or ranges are in place. Deviations are not raised for OpenConfig "must" statements, as the "must" statement in OpenConfig models is not supported in SR OS. The deviation file follows the naming format `nokia-sr-<OpenConfigModel>-deviations.yang`, for example, `nokia-sr-openconfig-network-instance-deviations.yang`.

It is not always necessary to use a deviation file where a specific function is not supported. For example, in the case of enumerations, when an enumerated OpenConfig value is not supported, the validation or commit function fails with an indication that the entry is not valid.

When a mapping exists for an attribute and the configuration is out of range, an error is generated. For example, the Nokia application configuration for leaf B has a range of 1 to 100, where the OpenConfig leaf B specifies a range of 1 to 300. When the OpenConfig value is set above 100, an unsupported value error message is returned.

As an example of a granularity mismatch, Nokia application leaf C supports centiseconds and OpenConfig leaf C supports milliseconds. If the OpenConfig value in milliseconds can be converted to a valid application value, the OpenConfig value is accepted. For example, OpenConfig leaf C 100 ms is converted to application leaf C 1 centisecond. However, if the OpenConfig value cannot be converted to a valid application value, an error is generated. For example, OpenConfig leaf C 125ms cannot be mapped into centiseconds.

Augments files are also included to add configuration for OpenConfig that is required by the Nokia application to function as expected. The augments file follows the naming format `nokia-sr-<OpenConfigModel>-augments.yang`.

3.3 Datastores and regions

As described in RFC 8342 a datastore is a conceptual place to store and access information. A datastore maps to an instantiated YANG data tree. See RFC 8342 for more information about datastores.

SR OS supports conventional configuration datastores (for example, running and candidate) as well as some proprietary datastores (for example, li-running).

SR OS also has a proprietary concept called a region (or configuration region). The set of branches and elements in the **configure** branch of the CLI are all located in the primary configuration region simply called **configure**. The majority of SR OS configuration is in the configuration region including ports, interfaces, services and filters. Examples of other regions are:

- **bof** (boot options file)
- **debug** (debugging configuration)
- **li** (lawful intercept)

Each region has its own configuration datastores (running, candidate, and so on). The saved configuration for each region is stored in a separate file on compact flash or remotely (for example, `bof.cfg`, `debug.cfg`, `config.cfg`, `li.cfg`). Regions are independently locked for configuration changes. See the output of the following command in the *7450 ESS, 7750 SR, 7950 XRS, and VSR Clear, Monitor, Show, and Tools Command Reference Guide* for an example of per-region per-datastore information.

```
show system management-interface datastore-locks
```

3.3.1 NMDA support

SR OS supports the Network Management Datastore Architecture (NMDA) for the <intended> and <operational> datastores. When the **nmda-support** command is enabled, the following changes to the YANG model advertisements for NETCONF occur:

- The `ietf-yang-library:1.1` revision 2019-01-04 YANG module is advertised in the hello capabilities replacing the `ietf-yang-library: 1.0` revision 2016-06-21 version.
- The following additional YANG modules are advertised in the hello capabilities:
 - `nokia-datastores`
 - `ietf-datastores`
 - `ietf-netconf-nmda`
 - `ietf-origin`
- The `ietf-yang-library` YANG module revision 2019-01-04 replaces the `ietf-yang-library` revision 2016-06-21 YANG module when using `ietf-netconf-monitoring` and `ietf-yang-library modules-state`.
- The following additional YANG modules are advertised when using `ietf-netconf-monitoring` and `ietf-yang-library modules-state`:
 - `nokia-datastores`
 - `ietf-datastores`
 - `ietf-netconf-nmda`
 - `ietf-origin`

3.4 SPC objects

System-Provisioned Configuration (SPC) objects (configuration list elements and their descendants) are provided as a convenience to users in SR OS.

There are two basic classes of SPC objects: deletable and non-deletable.

Deletable SPC objects are placed into the configuration by SR OS but can be deleted (removed) by a user. The following characteristics apply to deletable SPC objects.

- Deletable SPC objects can be removed or recreated via NETCONF <edit-config> requests.
- Deletable SPC objects that have not been removed are visible in a NETCONF <get-config> response.
- Deletable SPC objects that have been removed are not visible in model-driven interfaces.
- In the classic CLI these are removed by specifying the keyword **no**, which is then visible in an **info** command or in a saved config (**admin save**); for example, **no log-id 99**.
- The following list summarizes the deletable SPC objects in the SR OS (listed against their MD-CLI paths).

```
configure log filter 1001
configure log log-id (99,100)
configure system security user-params local-user user "admin"
configure system security aaa local-profiles profile "administrative"
configure system security aaa local-profiles profile "default"
configure system security ssh server-cipher-list-v2 cipher (190..230)
configure system security ssh client-cipher-list-v2 cipher (190..230)
configure system security ssh server-mac-list-v2 mac (200..240)
configure system security ssh client-mac-list-v2 mac (200..240)
```

Non-deletable SPC (ND-SPC) objects are not added to the configuration by SR OS, but they can be referenced by other parts of the configuration even if they are not visible as part of the configuration. The following characteristics apply to ND-SPC objects.

- Some ND-SPC objects contain leafs (or other descendant elements) that can be modified (for example, **cpu-protection policy 254**). Some ND-SPC objects cannot be modified (for example, **qos sap-ingress "default"**).
- ND-SPC objects are not displayed in model-driven interfaces as part of the configuration unless a user explicitly creates the object. This explicit creation of ND-SPC objects is only supported when operating in **model-driven** configuration mode; it is not supported in **mixed** configuration mode. When a user explicitly creates an ND-SPC object, SR OS remembers that it was explicitly created and displays it as part of the configuration. This may be useful for NETCONF clients and tools that perform offline validation of the configuration against the SR OS YANG models and to resolve leafrefs that point to ND-SPC objects.
- Deleted ND-SPC objects in model-driven interfaces no longer appear as part of the configuration. All descendant elements are reset as unconfigured.
- ND-SPC objects can be referenced by other parts of the configuration regardless of whether they have been modified or created.
- ND-SPC objects created inside a configuration group in model-driven interfaces do not appear in the output of **info intended** or **info inheritance**.

- ND-SPC objects are not displayed in the classic CLI as part of the configuration unless a child or descendant element is modified. Some exceptions to this behavior include the following examples.

```
configure service customer 1 name "1"
configure system security cpu-protection policy 254
```

- ND-SPC objects cannot be deleted in the classic CLI. A deletion attempt returns an error.
- The following non-deletable SPC objects are the common ones used.

```
configure service customer "1"
configure qos sap-egress queue 1
configure qos sap-ingress queue (1,11)
```

- The following list summarizes the non-deletable SPC objects in the SR OS (listed against their MD-CLI paths).



Note: Support for commands in the following list depends on the type of router. See the *7450 ESS, 7750 SR, 7950 XRS, and VSR MD-CLI Command Reference Guide* for support information.

```
bof port "management"
bof router "management"
bof router interface "management"
configure application-assurance group partition cflowd export-type ("volume","tcp-
performance","rtp-performance","comprehensive","pgw-edr")
configure application-assurance group partition policy app-group "Unknown"
configure application-assurance group partition policy application "Unknown"
configure application-assurance group partition statistics aa-sub-study
("protocol","application")
configure call-trace location (cf1,cf2)
configure call-trace trace-profile "default"
configure call-trace trace-profile "default"
configure card fp ingress network pool "default"
configure cflowd sample-profile 1
configure eth-cfm default-domain bridge-identifier <x>
configure filter log 101
configure lag scheduler vlan-qos-policy "default"
configure log log-events (adp event tmnxDiscoveryEndNotify ... wpp event tmnxWppPGHostAuth
Failed)
configure log log-id 101
configure multicast-management bandwidth-policy "default"
configure multicast-management multicast-info-policy "default"
configure multicast-management multicast-info-policy bundle "default"
configure oam-pm bin-group 1
configure oam-pm bin-group bin-type (fd,fdr,ifdv)
configure oam-pm bin-group bin-type bin (0..2)
configure port ethernet egress port-scheduler-policy overrides level (1..8)
configure port ethernet lldp dest-mac (nearest-bridge,nearest-non-tpmr,nearest-customer)
configure port ethernet lldp dest-mac tx-mgmt-address (oob,system,system-ipv6,oob-ipv6)
configure port scheduler vlan-qos-policy "default"
configure port tdm ds1 channel-group egress port-scheduler-policy overrides level (1..8)
configure port tdm ds3 channel-group egress port-scheduler-policy overrides level (1..8)
configure port tdm e1 channel-group egress port-scheduler-policy overrides level (1..8)
configure port tdm e3 channel-group egress port-scheduler-policy overrides level (1..8)
configure qos fp-resource-policy "default"
configure qos fp-resource-policy aggregate-shapers queue-sets size (2..8)
configure qos hw-aggr-shaper-scheduler-policy sched-class (1..6)
configure qos network "default"
configure qos network egress fc (be,l2,af,l1,h2,ef,h1,nc)
configure qos network ingress fc (be,l2,af,l1,h2,ef,h1,nc)
```

```

configure qos network-queue "default"
configure qos network-queue queue (1,9)
configure qos policer-control-policy root priority-mbs-thresholds priority (1..8)
configure qos policer-control-policy root tier (1,2)
configure qos port-scheduler-policy level (1..8)
configure qos queue-group-templates egress queue-group "policer-output-queues"
configure qos queue-group-templates egress queue-group queue 1
configure qos queue-group-templates egress queue-group sched-class-elevation sched-class
(1..6)
configure qos sap-egress "default"
configure qos sap-egress queue 1
configure qos sap-egress sched-class-elevation sched-class (1..6)
configure qos sap-ingress "default"
configure qos sap-ingress queue (1,11)
configure qos scheduler-policy tier (1..3)
configure qos shared-queue "egress-pbr-ingress-queues"
configure qos shared-queue "policer-output-queues"
configure qos shared-queue fc be
configure qos slope-policy "_tmnx_hs_default"
configure qos slope-policy "default"
configure router ("Base","management","vpls-management")
configure router bgp convergence family (ipv4,vpn-ipv4,ipv6,vpn-ipv6,label-ipv4,label-ipv6)
configure router bgp multipath family (ipv4,ipv6,label-ipv4,label-ipv6)
configure router bgp next-hop-resolution labeled-routes transport-tunnel family (vpn,label-
ipv4,label-ipv4)
configure router bgp next-hop-resolution shortcut-tunnel family (ipv4,ipv6)
configure router interface ("system","management")
configure router interface network-domains network-domain "default"
configure router isis 0 igp-shortcut tunnel-next-hop family (ipv4,ipv6,svr4,svr6)
configure router isis interface level (1,2)
configure router isis level (1,2)
configure router isis link-group level (1,2)
configure router isis segment-routing-v6 locator level (1,2)
configure router isis segment-routing-v6 micro-segment-locator level (1,2)
configure router mpls class-forwarding-policy fc (be,l2,af,l1,h2,ef,h1,nc)
configure router mpls interface "system"
configure router mpls lsp auto-bandwidth fc (be,l2,af,l1,h2,ef,h1,nc)
configure router mpls lsp-template auto-bandwidth fc (be,l2,af,l1,h2,ef,h1,nc)
configure router network-domains network-domain "default"
configure router network-domains network-domain "default"
configure router ospf igp-shortcut tunnel-next-hop family (ipv4,svr4)
configure router ospf3 igp-shortcut tunnel-next-hop family (ipv4,ipv6,svr4,svr6)
configure router p2mp-sr-tree p2mp-policy candidate-path path-instances (1,2)
configure router rsvp interface "system"
configure router sgt-qos...
configure service cpipe sap egress qos policer-control-policy overrides root priority-mbs-
thresholds priority (1..8)
configure service cpipe sap ingress qos policer-control-policy overrides root priority-mbs-
thresholds priority (1..8)
configure service customer "1"
configure service epipe sap egress qos policer-control-policy overrides root priority-mbs-
thresholds priority (1..8)
configure service epipe sap ingress qos policer-control-policy overrides root priority-mbs-
thresholds priority (1..8)
configure service ies interface sap egress qos policer-control-policy overrides root
priority-mbs-thresholds priority (1..8)
configure service ies interface sap ingress qos policer-control-policy overrides root
priority-mbs-thresholds priority (1..8)
configure service ies subscriber-interface group-interface wlan-gw vlan-range "unmatched"
configure service ipipe sap egress qos policer-control-policy overrides root priority-mbs-
thresholds priority (1..8)
configure service ipipe sap ingress qos policer-control-policy overrides root priority-mbs-
thresholds priority (1..8)

```

```

configure service vpls interface sap egress qos policer-control-policy overrides root
priority-mbs-thresholds priority (1..8)
configure service vpls interface sap ingress qos policer-control-policy overrides root
priority-mbs-thresholds priority (1..8)
configure service vprn bgp multipath family (ipv4,ipv6,label-ipv4,label-ipv6)
configure service vprn interface sap egress qos policer-control-policy overrides root
priority-mbs-thresholds priority (1..8)
configure service vprn interface sap ingress qos policer-control-policy overrides root
priority-mbs-thresholds priority (1..8)
configure service vprn isis interface level (1,2)
configure service vprn isis level (1,2)
configure service vprn isis link-group level (1,2)
configure service vprn sgt-qos...
configure service vprn subscriber-interface group-interface wlan-gw vlan-range "unmatched"
configure subscriber-mgmt gtp peer-profile ("default","default_s11")
configure subscriber-mgmt ipoe-session-policy "_tmnx_bonding"
configure subscriber-mgmt ipoe-session-policy "default"
configure subscriber-mgmt ppp-policy "default"
configure system alarm-contact-input (1..4)
configure system fp resource-allocation lpm scale-option (1..4)
configure system fp resource-allocation pool (1,2)
configure system power-management 1
configure system ptp router "Base"
configure system security cpu-protection policy (254,255)
configure system security dist-cpu-protection policy ("_default-access-policy", "_default-
network-policy", "_default-port-policy")
configure system security snmp access group (cli-li-readwrite,cli-readonly,cli-
readwrite,cli-vprn-readwrite,snmp-mgmt,snmp-ro,snmp-rw,snmp-rwa,snmp-trap,snmp-vpls-
mgmt,snmp-vprn,snmp-vprn-ro)
configure system security snmp view (iso,li-view,mgmt-view,no-security,vprn-view)
configure system security user-template {tacplus-default,radius-default,ldap-default}
configure system usb "cf2"
configure test-oam service-activation-testhead acceptance-criteria-template "default"
configure test-oam service-activation-testhead frame-size-template "default"
configure test-oam twamp twamp-light source-udp-port-pools port (64374..64383)

```

3.5 Prerequisites for using model-driven management interfaces with classic configurations

These sections apply to using model-driven management interfaces with existing classic configurations by changing the configuration mode. The classic configuration is automatically converted to model-driven configuration format by the system when the configuration mode is changed to model-driven. Before configuration editing is permitted in model-driven interfaces, **configure system management-interface configuration-mode** must be set to **model-driven** or **mixed** after the prerequisites are completed.

3.5.1 Transitioning between modes

About this task

Perform the following steps before setting the management interface configuration mode to mixed or model-driven.

Procedure

- Step 1.** Verify that the system configuration only contains commands that are supported in model-driven interfaces. For more information, see section "Unsupported Configuration in MD Interfaces" in the *SR OS R23.x.Rx Software Release Notes*, part number 3HE 19269 000 x TQZZA.
- Step 2.** Update the system configuration to meet the prerequisites described in [Prerequisites for using model-driven management interfaces with classic configurations](#).
- Step 3.** Perform a mode change configuration check as follows.

Use the following command to check if the configuration meets the preceding prerequisite reference requirements to change the management interface configuration mode. Incompatible configuration commands are displayed with an error reason if the prerequisite is not met.

```
tools perform system management-interface configuration-mode check
```



Note: The command does not check if the configuration contains commands that are unsupported in model-driven interfaces. For more information, see section "Unsupported Configuration in MD Interfaces" in the *SR OS R23.x.Rx Software Release Notes*, part number 3HE 19269 000 x TQZZA.

Example

The following example shows the output of the **configuration-mode check** command when there are incompatible configuration commands.

```
=====
Mode Switch Validation Check
=====
Current Mode      : classic          Desired Mode      : model-driven
Configure        : Errors Detected  LI               : No Errors
-----
Configuration Validation Errors
-----
1  : MINOR: MGMT_CORE #2004 Incompatible configuration - dynsvc-password
    configured in system security password
2  : MINOR: MGMT_CORE #2004 Incompatible configuration - 'eth-cfm association
    bridge-identifier' reference to service-id exists
3  : MINOR: MGMT_CORE #2004 Incompatible configuration - ca-profile cmpv2 url
    service-id references exist
4  : MINOR: MGMT_CORE #224 Entry does not exist (MD-CLI: configure policy-
    options policy-statement "PEERING_ROUTER_OUT" entry 50 from prefix-list)
-----
Action required: configuration requires updating before mode switch
=====
```

- Step 4.** Save and back up your configuration. Existing configuration is converted to the MD-CLI format if the mode is changed to model-driven and the saved configuration file is in MD-CLI format.
- Step 5.** Change the configuration mode to mixed or model-driven as follows.



Note:

- Depending on the size of the system configuration, transitioning from classic mode may take several seconds to several minutes while the model-driven database is populated and synchronized to the current configuration. During the transition period, configuration changes are not allowed and service is not affected.

- Transitioning to classic mode is immediate with no impact to services on the router.
- a. If using mixed mode, set the configuration mode to mixed by issuing the following commands:

```
configure system management-interface cli md-cli auto-config-save
configure system management-interface configuration-mode mixed
```

Log out and start a new CLI session to access the MD-CLI engine.

- b. If using model-driven mode, set the configuration mode to model-driven by issuing the following commands:

```
configure system management-interface cli md-cli auto-config-save
configure system management-interface configuration-mode model-driven
```

Log out and start a new CLI session to access the MD-CLI engine. When a new user session begins, the MD-CLI engine is available and the MD-CLI prompt is displayed.

Step 6. Save the configuration manually.

- In mixed mode, issue **admin save** from the classic CLI.
- In model-driven mode, issue **admin save** from the MD-CLI.

3.5.2 Configuring the CLI engine

The CLI engine refers to the CLI environment used in a user session (for example, console, Telnet, or SSH) to configure and operate the router. The CLI engine is either the classic CLI engine or the MD-CLI engine. The following terms are also used:

- preferred CLI engine** the CLI engine that is started at user login
- authorized CLI engine** a CLI engine that a user can switch to (using the CLI engine switch command ("/")) or where a user can execute commands
- active CLI engine** the CLI engine that is currently in use for a user session

The default preferred CLI engine and authorized CLI engines for a session are determined by the management interface configuration mode, which eliminates the need to explicitly configure the CLI engine. With the use of these dynamic defaults, it is possible to transition between the different configuration modes. [Table 22: Management interface configuration modes and CLI engines](#) summarizes the CLI engines for the management interface configuration modes.

Table 22: Management interface configuration modes and CLI engines

| Management interface configuration mode | Default preferred CLI engine | Default authorized CLI engines |
|---|------------------------------|---------------------------------|
| classic | classic-cli | classic-cli |
| mixed | classic-cli | md-cli, classic-cli |
| model-driven | md-cli | md-cli, classic-cli (read-only) |

The preferred and authorized CLI engines for a session can be changed to use either the classic CLI or the MD-CLI engine.

In the classic CLI, the first engine configured is the preferred CLI engine. The default is **no cli-engine**.

Example

```
A:node-2>config>system>management-interface>cli# cli-engine ?
- cli-engine <engine-type> [<engine-type>...(upto 2 max)]
- no cli-engine

<engine-type>          : classic-cli|md-cli
```

In the MD-CLI, the **cli-engine** command is a user-ordered list, and the first engine from that list is configured as the preferred CLI engine. Leaving the **cli-engine** command unconfigured (or deleting the **cli-engine** values) maintains or reverts to the dynamic default. [Table 23: MD-CLI cli-engine configurations](#) summarizes the supported actions for the MD-CLI **cli-engine** configuration.



Note: For the changes to the **cli-engine** command to take effect, log out of the CLI session and start a new session.

Table 23: MD-CLI cli-engine configurations

| cli-engine configuration | Preferred CLI engine | Authorized CLI engines | Description |
|--------------------------|----------------------|------------------------|---|
| [classic-cli] | classic-cli | classic-cli | User is restricted to the classic CLI engine |
| [classic-cli md-cli] | classic-cli | classic-cli, md-cli | User can switch between classic CLI and MD-CLI engines in a session |
| [md-cli classic-cli] | md-cli | md-cli, classic-cli | User can switch between MD-CLI and classic CLI engines in a session |
| [md-cli] | md-cli | md-cli | User is restricted to the MD-CLI engine |

3.5.3 Loose references to IDs

A loose reference does not require the target of the reference to exist in the configuration.

For example, when the management interface configuration mode is **classic**, you cannot configure the following command, even if **ip-filter 37** does not exist in the configuration.

```
configure service pw-template 23 egress filter ip 37
```

Before switching from the **classic** mode to **model-driven** or **mixed**, all loose references using IDs must be replaced with references using string names or removed from the configuration for the following elements:

- all services including the following;

```
configure service vprn
configure service vpls
```

```
configure service epipe
```

- the following mirror element

```
configure mirror mirror-dest
```

- the following service elements

```
configure service pw-templates
configure service customer
```

- the following filter elements

```
configure filter ip-filter
configure filter ipv6-filter
configure filter mac-filter
```

- the following QoS elements

```
configure qos network
configure qos sap-ingress
configure qos sap-egress
```

- the following Ethernet CFM elements

```
configure eth-cfm domain
configure eth-cfm association
```



Note: A name can only be assigned to a filter or any element in the preceding list of elements which use IDs as keys in classic interfaces but string names in model-driven interfaces. It is recommended to assign names to the elements before an upgrade to Release 15.1.R1. A name can also be changed in releases before Release 15.1.R1. Elements without names are automatically assigned a name (the ID converted to a string) during an upgrade to Release 15.1.R1 or later, and cannot be changed without manually deleting and recreating the element.

Loose references to IDs for the objects in the preceding list cannot be created while in **mixed** or **model-driven** configuration mode. Any classic CLI scripts must also be updated to avoid the use of any of the following commands.

In the following example, a configuration is shown for the service PW template egress filter.

Example

```
configure service pw-template 23 egress filter ip 37
```

You can change this configuration to the following.

```
configure service pw-template 23 egress filter-name ip ops-sec-filter-a33
```

Because **ip-filter 37** is a loose reference, it does not require a name for the configuration to be valid. However, you may want to assign a name as follows, to make the binding operational.

```
configure filter ip-filter 37 name ops-sec-filter-a33
```

The following lists the set of affected loose references. Some items take a service name as an input. SR OS converts these service names to IDs, and stores the IDs in the configuration. In these cases, the *service-name* becomes an alias at configuration edit time and is not stored as a reference.

IPsec related configuration:

```
configure service vprn interface sap ipsec-tunnel local-gateway-address
configure service vprn interface sap ip-tunnel delivery-service
configure service vprn interface sap l2tpv3-session router
configure service epipe sap l2tpv3-session router
configure service vpls sap l2tpv3-session router
configure service vprn interface sap ipsec-gw default-secure-service
configure service ies interface sap ipsec-gw default-secure-service
configure service vprn interface sap ipsec-gw dhcp server
configure service ies interface sap ipsec-gw dhcp server
configure service vprn interface sap ipsec-gw dhcp6 server
configure service ies interface sap ipsec-gw dhcp6 server
configure service vprn interface sap ipsec-gw local-address-assignment ipv4 address-source
configure service vprn interface sap ipsec-gw local-address-assignment ipv6 address-source
configure service ies interface sap ipsec-gw local-address-assignment ipv4 address-source
configure service ies interface sap ipsec-gw local-address-assignment ipv6 address-source
configure service vprn interface sap ipsec-tunnel bfd-enable
configure ipsec client-db client private-service
configure system file-transmission-profile router
```

eth-cfm, oam-pm, and saa:

```
configure eth-cfm domain association bridge-identifier
configure oam-pm session ip router
configure oam-pm session ip router service-name
configure saa test type cpe-ping service
configure saa test type icmp-ping router
configure saa test type icmp-ping service-name
configure saa test type icmp-trace router
configure saa test type icmp-trace service-name
configure saa test type mac-ping service
configure saa test type mac-trace service
configure saa test type vprn-ping
configure saa test type vprn-ping service
configure saa test type vprn-trace
configure saa test type vprn-trace service
```

Filters:

```
configure service pw-template egress filter ipv6
configure service pw-template egress filter ip
configure service pw-template egress filter mac
configure service pw-template ingress filter ipv6
configure service pw-template ingress filter ip
configure service pw-template ingress filter mac

configure service template epipe-sap-template egress filter ip
configure service template epipe-sap-template egress filter ipv6
configure service template epipe-sap-template egress filter mac
configure service template epipe-sap-template ingress filter ip
configure service template epipe-sap-template ingress filter ipv6
configure service template epipe-sap-template ingress filter mac
```

```

configure service template vpls-sap-template egress filter ip
configure service template vpls-sap-template egress filter ipv6
configure service template vpls-sap-template egress filter mac
configure service template vpls-sap-template ingress filter ip
configure service template vpls-sap-template ingress filter ipv6
configure service template vpls-sap-template ingress filter mac

configure li li-filter-block-reservation li-reserved-block ip-filter
configure li li-filter-block-reservation li-reserved-block ipv6-filter
configure li li-filter-block-reservation li-reserved-block mac-filter

```

PKI:

```

configure system security pki ca-profile cmpv2 url
configure system security pki ca-profile ocsf service

```

QoS:

```

configure service template epipe-sap-template ingress qos
configure service template epipe-sap-template egress qos

configure service template vpls-sap-template ingress qos
configure service template vpls-sap-template egress qos

configure service pw-template ingress qos
configure service pw-template egress qos

```

Subscriber management:

```

configure service ies subscriber-interface group-interface srrp bfd-enable
configure service vprn subscriber-interface group-interface srrp bfd-enable

configure subscriber-mgmt local-user-db ipoe host host-identification service-id
configure subscriber-mgmt local-user-db ipoe host interface service-id
configure subscriber-mgmt local-user-db ipoe host match-radius-proxy-cache server
configure subscriber-mgmt local-user-db ipoe host msap-defaults service
configure subscriber-mgmt local-user-db ipoe host retail-service-id

configure subscriber-mgmt local-user-db ppp host interface service-id
configure subscriber-mgmt local-user-db ppp host l2tp group service-id
configure subscriber-mgmt local-user-db ppp host msap-defaults service
configure subscriber-mgmt local-user-db ppp host retail-service-id

configure subscriber-mgmt msap-policy vpls-only-sap-parameters igmp-snooping mvr
from-vpls

configure service vpls sap msap-defaults service

```

Miscellaneous:

```

configure vrrp policy
configure service vprn interface vrrp bfd-enable

configure service vprn interface ipv6 vrrp bfd-enable
configure router l2tp group ppp default-group-interface service-id
configure router l2tp group tunnel ppp default-group-interface service-id
configure service vprn l2tp group ppp default-group-interface service-id
configure service vprn l2tp group tunnel ppp default-group-interface service-id

configure redundancy multi-chassis peer mc-ring l3-ring in-band-control-path

```

```

service-id
configure redundancy multi-chassis peer mc-ring l3-ring ring-node connectivity-
verify service-id
configure redundancy multi-chassis peer mc-ring ring in-band-control-path service-id
configure redundancy multi-chassis peer mc-ring ring ring-node connectivity-verify
service-id

configure open-flow of-switch of-controller vprn

```

3.5.4 Strict routing policy validation

Strict routing policy validation is used for model-driven interfaces. The routing policy must exist for the management interface configuration mode to be changed. Remove references to non-existent routing policies before attempting to switch modes. Strict policy validation is applied to the following routing policy references:

- ARP and ND in the Base router and VPRN instances
- BGP in the Base router and VPRN instances
- global and local variables in main policies and sub-policies
- IGMP, MLD, and PIM in the Base router and VPRN instances
- IS-IS in the Base router and VPRN instances
- LDP
- OSPF and OSPFv3 in the Base router and VPRN instances
- policy-option in **from**, **to**, **action**, and **default-action** statements
- policy-option in sub-policies, **prefix-list**, **as-path**, **as-path-group**, **damping**, and **community** policies
- RIP and RIPng in the Base router and VPRN instances
- RSVP
- single policy-statement or logical policy expressions
- static routes in the Base router and VPRN instances
- subscriber management, except for in **mld-policy** configuration for a local user database (LUDB) host
- VPLS for BGP VSI
- VPRN for GRT, MVPN, and VRF

3.5.5 String names as keys

Many elements use string names as keys in model-driven interfaces instead of the numerical identifiers used in the classic CLI and SNMP.



Note: The string name can only be assigned or modified for these elements in releases before Release 15.1.R1. Elements without names are automatically assigned a name (the identifier converted to a string) during an upgrade to Release 15.1.R1 or later, and cannot be changed without manually deleting and recreating the element.

It is recommended that you assign names to the following elements before an upgrade to Release 15.1 or later:

- all services including the following;

```
configure service vprn
configure service vpls
configure service epipe
```

- the following mirror element

```
configure mirror mirror-dest
```

- the following service elements

```
configure service pw-templates
configure service customer
```

- the following filter elements

```
configure filter ip-filter
configure filter ipv6-filter
configure filter mac-filter
```

- the following QoS elements

```
configure qos network
configure qos sap-ingress
configure qos sap-egress
```

- the following Ethernet CFM elements

```
configure eth-cfm domain
configure eth-cfm association
```

3.6 Commit history

The commit history provides a persistent history of configuration changes committed in model-driven interfaces. A separate history of the last commits (default 50, up to 200) is maintained for each configuration region (bof, configure, debug, and li). Each commit is uniquely identified by a numerical sequential incrementing commit ID assigned by the system.

In the MD-CLI, use the following show command to view the commit history or use the state model:

```
show system management-interface commit-history
state system management-interface configuration-region commit-history
```

The saved configuration file header also displays the commit history from the last configuration save.

An optional commit comment can be entered using the MD-CLI **commit comment** command or the NETCONF <commit> RPC. Newline separators (\n) can be entered in the comment string to display multiple comment lines.

The following example shows the first commit made by the system when the router boots, followed by two commits by a user with the MD-CLI.

Example: System and user commits with MD-CLI

```
[ex:/configure]
A:admin@node-2# commit comment "Second commit with the MD-CLI."

[ex:/configure]
A:admin@node-2# commit comment "Third commit with the MD-CLI."

[ex:/configure]
A:admin@node-2# show system management-interface commit-history

=====
Commit History
=====
Total Commits : 3

3
  Committed 2022-02-01T11:01:03.8-05:00 by admin (MD-CLI) from 10.1.145.205
  Comment   "Third commit with the MD-CLI."
  Location  "cf3:\config.cfg"
2
  Committed 2022-02-01T11:00:47.7-05:00 by admin (MD-CLI) from 10.1.145.205
  Comment   "Second commit with the MD-CLI."
  Location  "cf3:\config.cfg.1"
1
  Committed 2022-02-01T10:56:01.3-05:00 by system (MD-CLI) from Console
  Log       "System booted version B-22.2.R1."
  Location  "Configuration is not saved to startup."
```

The following example shows a fourth commit made by automation using the NETCONF <commit> RPC with the <comment> augmentation.

Example: NETCONF <commit> RPC with <comment> augmentation

```
<rpc message-id="101" xmlns="urn:ietf:params:xml:ns:netconf:base:1.0">
  <commit>
    <comment>Fourth commit with NETCONF.</comment>
  </commit>
</rpc>
]]>]]>
```

Use the following command to display the commit history after the preceding activity.

```
show system management-interface commit-history
```

Output example

```
=====
Commit History
=====
Total Commits : 4

4
  Committed 2022-02-01T11:13:38.7-05:00 by admin (NETCONF) from 10.1.236.68
  Comment   "Fourth commit with NETCONF."
  Location  "cf3:\config.cfg"
3
  Committed 2022-02-01T11:01:03.8-05:00 by admin (MD-CLI) from 10.1.145.205
  Comment   "Third commit with the MD-CLI."
  Location  "cf3:\config.cfg.1"
2
```

```

Committed 2022-02-01T11:00:47.7-05:00 by admin (MD-CLI) from 10.1.145.205
Comment   "Second commit with the MD-CLI."
Location  "cf3:\config.cfg.2"
1
Committed 2022-02-01T10:56:01.3-05:00 by system (MD-CLI) from Console
Log       "System booted version 22.2.R1."
Location  "Configuration is not saved to startup."

```

The following usage guidelines apply to the commit history.

- The commit history is supported in model-driven configuration mode only.
- The system files located in the `cf3:\.commit-history` directory must not be edited or deleted, and user files must not be stored there.
- Saved configuration files that are referenced by the commit must not be edited or deleted.
- Editing the BOF from the boot loader does not create a commit history entry.
- Nokia recommends setting the commit history value to at least 50, which is the default value. The commit history can be disabled by setting the value to 0.
- Use the MD-CLI **environment time-format** and **environment time-display** options to change the time formats displayed in the output of the following commands.

```

show system management-interface commit-history
info state system management-interface <region-name> commit-history
admin show configuration

```

The time formats in **admin show configuration** are in the generated and finished lines.

- The MD-CLI **environment** commands do not change any time formats in the saved configuration file header or footer. These time formats are always written in RFC 3339 format in the Coordinated Universal Time (UTC) or local time zone. Use the following command to configure the value.

```

configure system time prefer-local-time

```

3.7 Incremental saved configuration files

When incremental saved configuration files are enabled, the system saves each configuration commit to the **configure** configuration region in a separate incremental saved configuration file, instead of saving a complete saved configuration file each time. This mechanism makes commits over model-driven interfaces (the MD-CLI, NETCONF and gRPC/gNMI) much faster, because less configuration needs to be saved.

When the system boots or the **rollback** command is issued, the last complete saved configuration file is loaded first, and then any required incremental saved configuration files are loaded in the sequence they were committed to apply the previous saved configuration.

The commit history displays information about incremental and complete saved configuration files. The "Location" field displays the complete saved configuration file location, and the "Increment" field displays the incremental saved configuration file location. When the "Location" field is not displayed, the incremental saved configuration file in the "Increment" field is loaded as described above.

Use the following command to show the commit history.

```

show system management-interface commit-history

```

Output example: Commit history showing the incremental saved configuration file location

```

=====
Commit History
=====
Total Commits : 2

2
  Committed 2022-06-21T12:55:05.4-04:00 by admin (MD-CLI) from 192.168.0.10
  Increment "cf3:\.commit-history\config-2022-06-21T16-55-05.4Z-4.is"

1
  Committed 2022-06-21T12:49:31.4-04:00 by admin (MD-CLI) from 192.168.0.10
  Increment "cf3:\.commit-history\config-2022-06-21T16-49-31.4Z-3.is"
  Location "cf3:\config.cfg"

```

A background process generates a complete saved configuration file periodically to reduce the number of incremental saved configuration files that are needed by system. The commit history is updated with a "Location" field like in the following example.

Output example: Commit history showing the complete saved configuration file location

```

=====
Commit History
=====
Total Commits : 2

2
  Committed 2022-06-21T12:55:05.4-04:00 by admin (MD-CLI) from 192.168.0.10
  Increment "cf3:\.commit-history\config-2022-06-21T16-55-05.4Z-4.is"
  Location "cf3:\config.cfg"

1
  Committed 2022-06-21T12:49:31.4-04:00 by admin (MD-CLI) from 192.168.0.10
  Increment "cf3:\.commit-history\config-2022-06-21T16-49-31.4Z-3.is"
  Location "cf3:\config.cfg.1"

```

Incremental saved configuration files are enabled with the **configure system management-interface configuration-save incremental-saves** command, and must be configured together with the following commands.

- **configure system management-interface configuration-mode** must be **model-driven**
- **configure system grpc gnmi auto-config-save** must be set to **true**
- **configure system management-interface cli md-cli auto-config-save** must be set to **true**
- **configure system management-interface netconf auto-config-save** must be set to **true**
- **configure system management-interface commit-history** must be ≥ 50
- **configure system management-interface configuration-save configuration-backup** must be \geq **configure system management-interface commit-history**
- **configure redundancy synchronize** must be **config** or **boot-env** on systems that support redundancy

The following usage guidelines apply:

- The commit history and incremental saved configuration files in the `cf3:\.commit-history` directory must not be edited by the user
- Multiple configuration save and synchronization events occur because additional system files are saved and synchronized between the active and standby CPM

- The first commit after a system boot or ISSU is followed by a complete save if an **admin save** command was not executed
- The configuration must be saved by executing the **admin save** command before executing the **admin redundancy force-switchover** command

3.8 YANG-modeled operations

In addition to YANG-based configuration and state, the SR OS also supports YANG-based operations (for example, **admin reboot**, **file remove**).

The SR OS YANG-modeled operations infrastructure applies to MD-CLI and NETCONF interfaces and is supported in any management interface configuration mode (classic, mixed, or model-driven). It is not applicable to operations requested in classic CLI, SNMP, or gRPC interfaces.

YANG-based operations are allocated an operation ID. You can examine the details of an operation, including the following information:

- execution status of the operation: in-progress, terminated, or terminated-incomplete
- start-time of the operation
- timeouts associated with the operation

Use the following command to configure the operation ID as an index into the global operations table to examine the details of an operation.

```
state system management-interface operations operation
```

Example: Contents of the global operations table when a file remove-directory command is in progress

```
[/]
A:admin@node-2# info state system management-interface operations
  oldest-operation-id 4
  newest-operation-id 4
  operation 4 {
    asynchronous false
    status in-progress
    start-time 2021-04-13T16:13:18.1+00:00
    request-path "/file/remove-directory"
    session-id 13
    user "admin"
  }
```

Configure and use the operation ID to remove an operation. Use the following command to remove an operation:

```
admin system management-interface operations delete-operation
```

In the case where the global operations table is full, the **delete-operation** command can optionally be requested with the **op-table-bypass** option to avoid allocating an *operation-id* and requiring an empty entry in the table.

3.8.1 Asynchronous versus synchronous operations

SR OS supports the following basic response modes for YANG-modeled operations:

- **synchronous**

This is the default response mode. This mode is supported on MD-CLI and NETCONF.

- **asynchronous**

This mode is supported only on NETCONF.

In synchronous mode, the response to the operation request contains the complete result data and is held until the operation is complete. No additional operations can be initiated in the same management session (MD-CLI or NETCONF) until the previous operation completes. This behavior is evident in MD-CLI, for example, where the MD-CLI prompt does not return and no input is accepted until the currently running operation is completed.

In asynchronous mode, the response to the operation request does not contain the result data and is sent without waiting for the operation to complete. The request only starts the operation and the client (requester) obtains the result later. Users can perform other commands in the management session while the asynchronous operation runs in the background.

The response to an asynchronous operation request contains an operation ID. This ID is a handle for the operation and allows users to:

- query the status of the operation
- stop or delete the operation

Synchronous operations require a management session (NETCONF or MD-CLI) for each concurrent operation, whereas a single management session can manage hundreds of concurrent asynchronous operations.

Only a subset of SR OS operational commands are supported in the asynchronous response mode. See the SR OS `nokia-oper-*.yang` files for actions with the "asynchronous" leaf as part of the input to identify operations that support asynchronous mode.

The following figure shows a typical flow for an asynchronous operation.

Figure 14: Asynchronous operation flow

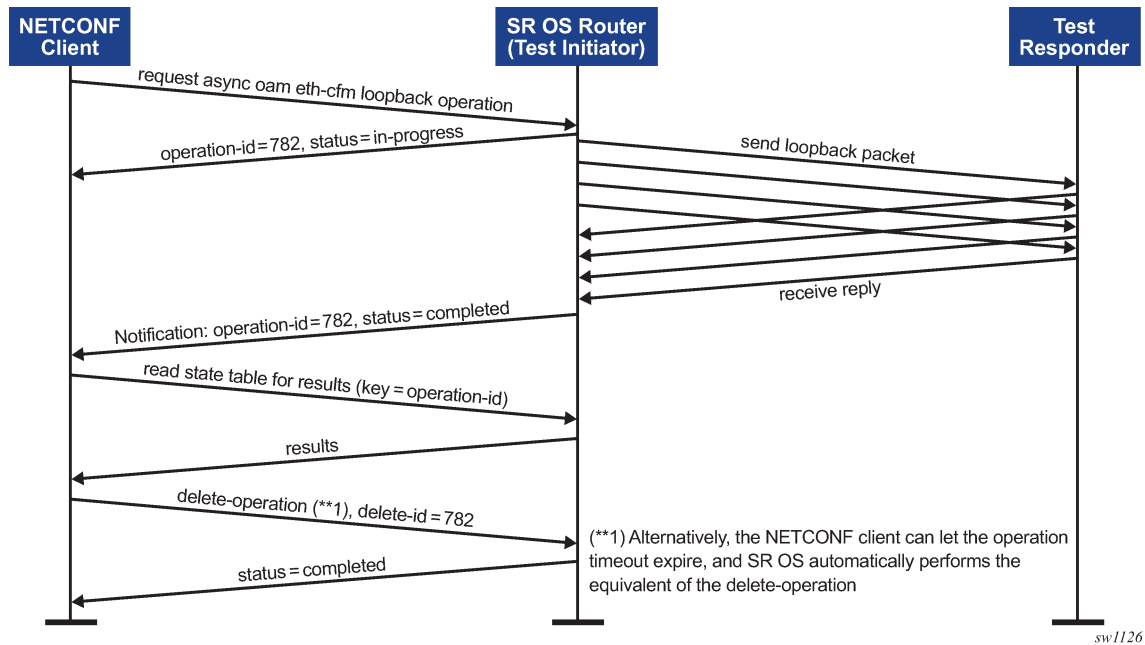

A stopped asynchronous operation (for example, stopped using the **stop-operation** command) stays in the global operations table until it is explicitly deleted using a **delete-operation** command or the retention timeout expires. Synchronous operations are automatically removed from the global operations table when they are completed or stopped.

**Note:**

Because of the parallel processing nature of asynchronous operations, it is possible that an operation completes before the original requester of the operation receives a reply to the request. This means a client could receive a notification about an operation ID that the client does not yet know about.

3.8.2 Examples of operations in the MD-CLI

All operations in the MD-CLI execute in synchronous response mode.

The following example shows an operation with no specific result data to return.

Example: MD-CLI operation with no result data to return

```
[/]
A:admin@mode-2# admin clear security password-history all
```

The following examples show operations that return result data.

Example: MD-CLI operation with result data

```
[/]
A:admin@node-2# file version cf3://image/both.tim
TiMOS-C-21.5.R1 for x86_64
```

```
Wed May 19 15:02:26 PDT 2021 by builder in /builds/c/215B/R1/panos/main/sros
```

The following example shows another operation that returns result data.

```
[/]
A:node-2# oam eth-cfm loopback aa:bb:cc:dd:ee:22 md-admin-name MyDomain
ma-admin-name MyAssociation mep-id 1 size 0 send-count 5 interval 10 timeout 5

Eth-Cfm Loopback Test Initiated: Mac-Address: aa:bb:cc:dd:ee:22, out sap: 2/2/1:20

38 bytes; lb_seq=1 passed
38 bytes; lb_seq=2 passed
38 bytes; lb_seq=3 passed
38 bytes; lb_seq=4 passed
38 bytes; lb_seq=5 passed

Sent 5 packets, received 5 packets [0 out-of-order, 0 Bad Msdu]
Packet loss 0.00%
```

3.8.3 Examples of synchronous operations in NETCONF

The following example shows synchronous operation that returns no result data.

Example: synchronous operation that returns no result data

Request:

```
<?xml version="1.0" encoding="UTF-8"?>
<rpc message-id="101" xmlns="urn:iETF:params:xml:ns:netconf:base:1.0">
  <action xmlns="urn:iETF:params:xml:ns:yang:1">
    <admin xmlns="urn:nokia.com:sros:ns:yang:sr:oper-admin">
      <clear>
        <security>
          <password-history>
            <all/>
          </password-history>
        </security>
      </clear>
    </admin>
  </action>
</rpc>
]]>]]>
```

Response:

```
<?xml version="1.0" encoding="UTF-8"?>
  xmlns:nokiaoper="urn:nokia.com:sros:ns:yang:sr:oper-admin">
  <nokiaoper:operation-id>12</nokiaoper:operation-id>
  <nokiaoper:start-time>2021-06-16T20:11:44.9Z</nokiaoper:start-time>
  <nokiaoper:status>completed</nokiaoper:status>
  <nokiaoper:end-time>2021-06-16T20:11:44.9Z</nokiaoper:end-time>
</rpc-reply>
]]>]]>
```

The following example shows a synchronous operation that returns result data.

Example: synchronous operation that returns result data

Request:

```
<?xml version="1.0" encoding="UTF-8"?>
<rpc message-id="101" xmlns="urn:ietf:params:xml:ns:netconf:base:1.0">
  <action xmlns="urn:ietf:params:xml:ns:yang:1">
    <file xmlns="urn:nokia.com:sros:ns:yang:sr:oper-file">
      <version>
        <url>cf3://image/both.tim</url>
      </version>
    </file>
  </action>
</rpc>
]]>]]>
```

Response:

```
<rpc-reply message-id="101" xmlns="urn:ietf:params:xml:ns:netconf:base:1.0"
  xmlns:nokiaoper="urn:nokia.com:sros:ns:yang:sr:oper-file">
  <nokiaoper:operation-id>17</nokiaoper:operation-id>
  <nokiaoper:start-time>2021-06-16T20:37:40.3Z</nokiaoper:start-time>
  <nokiaoper:results>
    <nokiaoper:version>
      <nokiaoper:version-number>C-21.5.R1</nokiaoper:version-number>
      <nokiaoper:version-string>TiMOS-C-21.5.R1 for x86_64 Wed May 19 15:02:26
        PDT 2021 by builder in /builds/c/215B/R1/panos/main/sros</nokiaoper:
        version-string>
    </nokiaoper:version>
  </nokiaoper:results>
  <nokiaoper:status>completed</nokiaoper:status>
  <nokiaoper:end-time>2021-06-16T20:37:40.4Z</nokiaoper:end-time>
</rpc-reply>
]]>]]>
```

To see log events for synchronous operations, MGMT_CORE event #2006 (syncOperationsStatusChange) must first be enabled by configuring it to generate events using the following command:

- **MD-CLI**

```
configure log log-events mgmt-core event syncOperationStatusChange generate
```

- **classic CLI**

```
configure log event-control "mgmt_core" syncOperationStatusChange generate
```

3.8.4 Examples of asynchronous operations in NETCONF

The following example shows asynchronous operations in NETCONF.

Example: asynchronous operations in NETCONF

Request:

```
<?xml version="1.0" encoding="UTF-8"?>
<rpc message-id="101" xmlns="urn:ietf:params:xml:ns:netconf:base:1.0">
  <action xmlns="urn:ietf:params:xml:ns:yang:1">
    <global-operations xmlns="urn:nokia.com:sros:ns:yang:sr:oper-global">
```



```

    <oam>
      <eth-cfm>
        <loopback>
          <asynchronous>true</asynchronous>
          <destination>aa:bb:cc:dd:ee:22</destination>
          <md-admin-name>MyDomain</md-admin-name>
          <ma-admin-name>MyAssociation</ma-admin-name>
          <mep-id>1</mep-id>
          <send-count>5</send-count>
          <timeout>5</timeout>
          <interval>10</interval>
        </loopback>
      </eth-cfm>
    </oam>
  </global-operations>
</action>
</rpc>
]]>]]>

```

Response:

```

<?xml version="1.0" encoding="UTF-8"?>
<rpc-reply message-id="101" xmlns="urn:ietf:params:xml:ns:netconf:base:1.0"
  xmlns:nokiaoper="urn:nokia.com:sros:ns:yang:sr:oper-global">
  <nokiaoper:operation-id>111</nokiaoper:operation-id>
  <nokiaoper:start-time>2021-06-16T14:17:18.3Z</nokiaoper:start-time>
  <nokiaoper:status>in-progress</nokiaoper:status>
</rpc-reply>
]]>]]>

```

The following example shows the global operations table status while the operation is running.

Example: global operations table status while an operation is running

```

[/]
A:admin@node-2# info state system management-interface operations
oldest-operation-id 111
newest-operation-id 111
operation 111 {
  asynchronous true
  status in-progress
  start-time 2021-06-16T10:17:18.3-04:00
  request-path "/global-operations/oam/eth-cfm/loopback"
  session-id 21
  user "admin"
  execution-timeout {
    time 2021-06-16T11:17:18.3-04:00
    remaining 3599
  }
}
next-execution-timeout {
  operation-id 111
  time 2021-06-16T11:17:18.3-04:00
  remaining 3599
}

```

Use the following command to display log event output when the operation is completed.

```
show log log-id 99
```

The following example shows the log event output.



Note: Log events for asynchronous actions are enabled by default, but for synchronous operations, the log events are disabled by default. For more information, see [Examples of synchronous operations in NETCONF](#).

Output example: Display log event output for completed operations

```

=====
Event Log 99 log-name 99
=====
Description : Default System Log
Memory Log contents [size=500  next event=5  (not wrapped)]

4 2021/06/16 10:17:22.400 EDT WARNING: MGMT_CORE #2005 Base Operation
"operation-id 111 finished with status completed. Presence of messages in the global
operations
table: error-messages false, warning-messages false, info-messages false."

```

The following is an example of the results available in the state branch.

Example: Results available in the state branch

```

[/]
A:admin@node-2# info state eth-cfm domain MyDomain association MyAssociation mep 1
  loopback-results {
    unicast-latest-run {
      test-status completed
      start-time 2021-06-16T10:17:18.0-04:00
      end-time 2021-06-16T10:17:22.0-04:00
      destination-mac-address aa:bb:cc:dd:ee:22
      statistics {
        sent-packets 5
        received-in-order 5
        received-out-of-order 0
        received-bad-msdu 0
        packet-loss 0.0
      }
    }
    multicast-latest-run {
      statistics {
        sent-packets 0
        received-packets 0
      }
    }
  }
}

```

The following example shows the delete operation usage to clean up.

Example: Delete operation usage to clean up

```

<?xml version="1.0" encoding="UTF-8"?>
<rpc message-id="101" xmlns="urn:ietf:params:xml:ns:netconf:base:1.0">
  <action xmlns="urn:ietf:params:xml:ns:yang:1">
    <admin xmlns="urn:nokia.com:sros:ns:yang:sr:oper-admin">
      <system>
        <management-interface>
          <operations>
            <delete-operation>
              <delete-id>111</delete-id>
            </delete-operation>
          </operations>
        </management-interface>
      </system>
    </admin>
  </action>
</rpc>

```

```
        </system>
      </admin>
    </action>
  </rpc>
]]>]]>
<rpc-reply message-id="101" xmlns="urn:ietf:params:xml:ns:netconf:base:1.0"
  xmlns:nokiaoper="urn:nokia.com:sros:ns:yang:sr:oper-admin">
  <nokiaoper:operation-id>112</nokiaoper:operation-id>
  <nokiaoper:start-time>2021-06-16T14:17:38.5Z</nokiaoper:start-time>
  <nokiaoper:status>completed</nokiaoper:status>
  <nokiaoper:end-time>2021-06-16T14:17:38.6Z</nokiaoper:end-time>
</rpc-reply>
]]>]]>
```

4 SNMP

4.1 SNMP overview

This section provides an overview of the Simple Network Management Protocol (SNMP).

4.1.1 SNMP architecture

The Nokia Network Services Platform (NSP) is composed of managers and SNMP agents. The manager is the entity through which network management tasks are facilitated. Agents interface managed objects. Managed devices, such as bridges, hubs, routers, and network servers can contain managed objects. A managed object can be a configuration attribute, performance statistic, or control action that is directly related to the operation of a device.

Managed devices collect and store management information and use Simple Network Management Protocol (SNMP). SNMP is an application-layer protocol that provides a message format to facilitate communication between SNMP managers and agents. SNMP provides a standard framework to monitor and manage devices in a network from a central location.

An SNMP manager controls and monitors the activities of network hosts which use SNMP. An SNMP manager can obtain (get) a value from an SNMP agent or store (set) a value in the agent. The manager uses definitions in the management information base (MIB) to perform operations on the managed device such as retrieving values from variables or blocks of data, replying to requests, and processing traps.

Between the SNMP agent and the SNMP manager the following actions can occur:

- The manager can get information from the agent.
- The manager can set the value of a MIB object that is controlled by an agent.
- The agent can send traps to notify the manager of significant events that occur on the router.

4.1.2 Management information base

A MIB is a formal specifications document with definitions of management information used to remotely monitor, configure, and control a managed device or network system. The agent's management information consists of a set of network objects that can be managed with SNMP. Object identifiers are unique object names that are organized in a hierarchical tree structure. The main branches are defined by the Internet Engineering Task Force (IETF). When requested, the Internet Assigned Numbers Authority (IANA) assigns a unique branch for use by a private organization or company. The branch assigned to Nokia (TiMetra) is 1.3.6.1.4.1.6527.

The SNMP agent provides management information to support a collection of IETF specified MIBs and a number of MIBs defined to manage devices and network data unique to Nokia's router.

4.1.3 SNMP protocol operations

Between the SNMP agent and the SNMP manager the following actions can occur:

- The manager can get information from the agent.
- The manager can set the value of a MIB object that is controlled by an agent.
- The agent notifies the manager of significant events that occur on the router.

4.1.4 SNMP versions

The agent supports multiple versions of the SNMP protocol:

- SNMP Version 1 (SNMPv1) is the original Internet-standard network management framework. SNMPv1 uses a community string match for authentication.
- The OS implementation uses SNMPv2c, the community-based administrative framework for SNMPv2. SNMPv2c uses a community string match for authentication.
- In SNMP Version 3 (SNMPv3), USM defines the user authentication and encryption features. View Access Control MIB (VACM) defines the user access control features. The SNMP-COMMUNITY-MIB is used to associate SNMPv1/SNMPv2c community strings with SNMPv3 VACM access control. SNMPv3 uses a username match for authentication.

4.1.5 SNMPv3 authentication and privacy protocols

The following SNMPv3 authentication protocols are supported:

- HMAC-MD5-96
- HMAC-SHA-96
- HMAC-SHA-224
- HMAC-SHA-256
- HMAC-SHA-384
- HMAC-SHA-512

The following SNMPv3 privacy protocols are supported:

- CBC-DES
- CFB128-AES-128
- CFB128-AES-192
- CFB128-AES-256

4.1.6 Management information access control

By default, the OS implementation of SNMP uses SNMPv3. SNMPv3 incorporates security model and security level features. A security model is the authentication type for the group and the security level is the permitted level of security within a security model. The combination of the security level and security model determines which security mechanism handles an SNMP packet.

To implement SNMPv1 and SNMPv2c configurations, several access groups are predefined. These access groups provide standard read-only, read-write, and read-write-all access groups and views that can simply be assigned community strings. To implement SNMP with security features, security models, security levels, and USM communities must be explicitly configured. Optionally, additional views which specify more specific OIDs (MIB objects in the subtree) can be configured.

Access to the management information in as SNMPv1/SNMPv2c agent is controlled by the inclusion of a community name string in the SNMP request. The community defines the sub-set of the agent's managed objects can be accessed by the requester. It also defines what type of access is allowed: read-only or read-write.

The use of community strings provide minimal security and context checking for both agents and managers that receive requests and initiate trap operations. A community string is a text string that acts like a password to allow access to the agent on the router.

Nokia's implementation of SNMP has defined three levels of community-named access:

read-only

grants only read access to objects in the MIB, except security objects

read-write

grants read and write access to all objects in the MIB, except security objects

read-write-all

grants read and write access to all objects in the MIB, including security objects

4.1.7 User-based security model community strings

User-based security model (USM) community strings associates a community string with an SNMPv3 access group and its view. The access granted with a community string is restricted to the scope of the configured group.

4.1.8 Views

Views control the access to a managed object. The total MIB of a router can be viewed as a hierarchical tree. When a view is created, either the entire tree or a portion of the tree can be specified and made available to a user to manage the objects contained in the subtree. Object identifiers (OIDs) uniquely identify managed objects. A view defines the type of operations for the view such as read, write, or notify.

OIDs are organized in a hierarchical tree with specific values assigned to different organizations. A view defines a subset of the agent's managed objects controlled by the access rules associated with that view.

The Nokia SNMP agent associates SNMPv1 and SNMPv2c community strings with a SNMPv3 view.

Use the commands in the following context to configure SNMP views.

```
configure system security snmp view
```

The following system-provisioned views are particularly useful when configuring SNMPv1 and SNMPv2c:

- **iso**

It is intended for administrative-type access to the entire supported object tree (except Lawful Interception). Use the commands in the following context to configure the "ISO" view automatically associated with any SNMP community that has access permissions of r, re, or raw.

```
configure system security snmp
```

- **no security**

Similar to ISO view, you can remove access to several security areas of the object tree (such as SNMP communities, user and profile configuration, SNMP engine ID, and so on). The no-security view is generally recommended over the ISO view to reduce access to security objects.

- **LI view**

This view provides access to a small set of Lawful Interception related objects.

- **GMT view**

This view provides access to IF-MIB and a few other basics. Use the commands in the following context to automatically associate the management view with any SNMP community that has an access-permission of GMT, as configured in the following context.

```
configure system security snmp
```

- **VPRN view**

This limits access to objects associated with a specific VPRN (for example, the per-VPRN logs and SNMP access feature). Use the commands in the following context to automatically associate the VPRN view with any SNMP community configured in the following context.

```
configure service vprn snmp
```

4.1.9 Access groups

Access groups associate a user group and a security model to the views the group can access. An access group is defined by a unique combination of a group name, security model (SNMPv1, SNMPv2c, or SNMPv3), and security level (no-authorization-no-privacy, authorization-no-privacy, or privacy).

An access group, in essence, is a template which defines a combination of access privileges and views. A group can be associated with one or more network users to control their access privileges and views.

When configuring access groups, the no-security view is generally recommended over the iso view to restrict access to security objects.

A set of system-provisioned access groups and system-created communities are available in SR OS. The system-provisioned groups and communities that begin with "cli-" are only used for internal CLI management purposes and are not exposed to external SNMP access.

Additional access must be explicitly configured if the preconfigured access groups and views for SNMPv1 and SNMPv2c do not meet your security requirements.

4.1.10 Users

By default, authentication and encryption are not configured. You can modify the authentication that a user must use to be validated by the router. SNMP authentication allows the device to validate the managing node that issued the SNMP message and determine if the message has been tampered with.

User access and authentication privileges must be explicitly configured. In a user configuration, a user is associated with an access group, which is a collection of users who have common access privileges and views (see [Access groups](#)).

4.1.11 Per-VPRN logs and SNMP access

Configuration of VPRN-specific logs (with VPRN-specific syslog destinations, SNMP trap, notification groups, and so on) is supported in addition to the global logs configured under **configure log**. By default, the event streams for VPRN logs contain only events that are associated with the particular VPRN.

Use the following command to enable access to the entire system-wide set of events (VPRN and non-VPRN).

```
configure log services-all-events
```

Each VPRN service can be configured with a set of SNMP v1/v2c community strings. These communities are associated with the system provisioned SNMP view called "vprn-view", which limits SNMP access to objects associated with a specific VPRN (along with a few basic system level OIDs).

SNMP communities configured under a VPRN are also associated with the SNMP context "vprn". For example, walking the ifTable (IF-MIB) using the community configured for VPRN 5 returns counters and status for interfaces in VPRN 5 only.

4.1.12 Per-SNMP community source IP address validation

SNMPv1 and SNMPv2c requests can be validated against per-snmp-community allow lists of configured source IPv4 and IPv6 addresses. Source IP address lists can be configured and then associated with an SNMP community.

Use the command options in the following context to configure source access lists:

- **MD-CLI**

```
configure system security snmp source-access-list
```

- **classic CLI**

```
configure system security snmp src-access-list
```

SNMPv1 and SNMPv2c requests that fail the source IP address and community validation checks are discarded and are logged as SNMP event 2003 authenticationFailure (suppressed by default under "event-control").

4.2 SNMP versions

SNMPv1 and SNMPv2c do not provide security, authentication, or encryption. Without authentication, a non-authorized user could perform SNMP network management functions and eavesdrop on management information as it passes from system to system. Many SNMPv1 and SNMPv2c implementations are restricted read-only access, which, in turn, reduces the effectiveness of a network monitor in which network control applications cannot be supported.

To implement SNMPv3, an authentication and encryption method must be assigned to a user to be validated by the router. SNMP authentication allows the router to validate the managing node that issued the SNMP message and determine if the message was tampered with.

Figure 15: [SNMPv1 and SNMPv2c configuration and implementation flow](#) depicts the configuration requirements to implement SNMPv1/SNMPv2c and SNMPv3.

Figure 15: *SNMPv1 and SNMPv2c configuration and implementation flow*

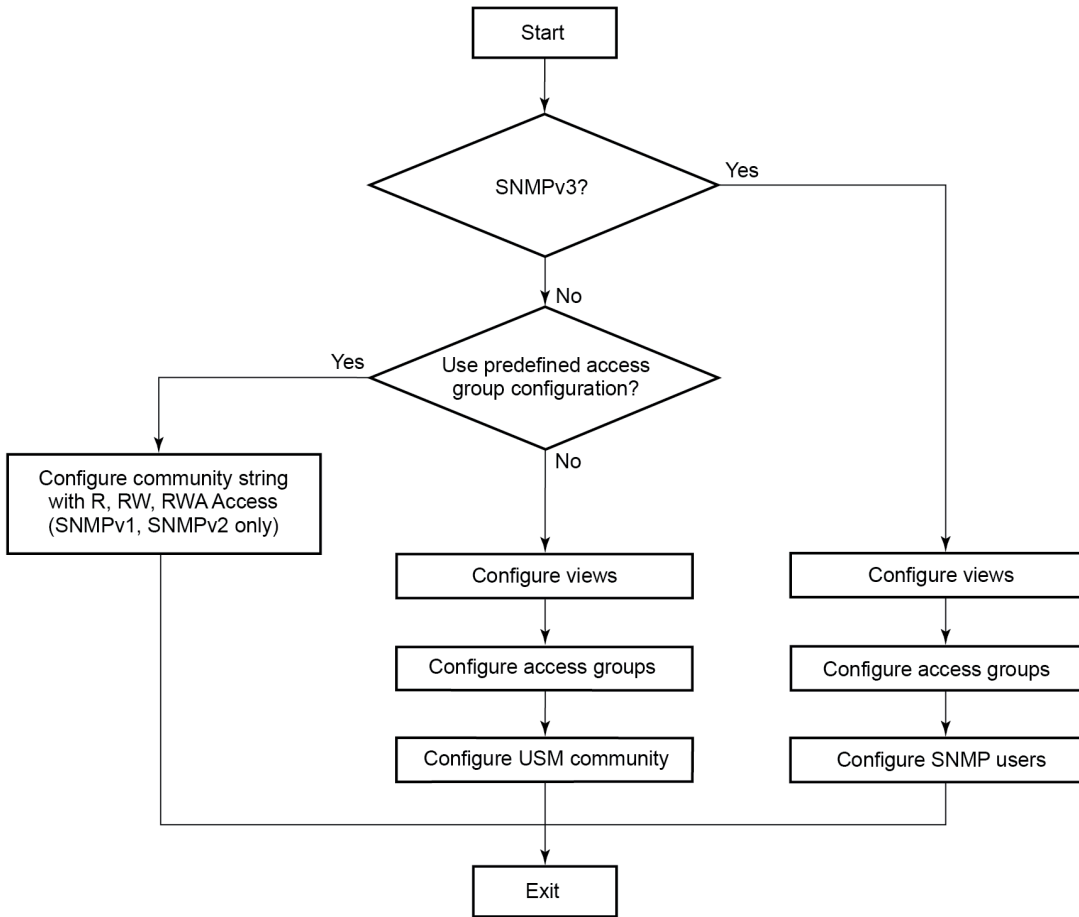

al_0203

4.3 Best practices for SNMP information retrieval

This section describes best practices for achieving optimal performance when retrieving high volumes of data from SR OS using SNMP.

4.3.1 SNMP GetBulkRequest

The SNMP GetBulkRequest method should be used instead of GetRequest or GetNextRequest.

During GetBulkRequest processing, the SR OS SNMP layer uses all the objects from the application data that it can from the returned table row to continue filling in the SNMP reply.

To maximize the advantage of SR OS pre-fetching and caching optimizations, construct GetBulkRequests with a sequential list of OIDs that represent sequential columns from the same SNMP table row. For example, enter the following objects and OIDs in the GetBulkRequest request to perform a row-by-row retrieval:

```
interface A, counter 1, counter 2, counter 3, counter N
interface B, counter 1, counter 2, counter 3, counter N
...
interface Z, counter 1, counter 2, counter 3, counter N
```

Do not perform column-by-column retrievals for GetBulkRequest requests, as in the following example:

```
interface A, counter 1
interface B, counter 1
...
interface Z, counter 1
interface A, counter 2
interface B, counter 2
...
interface Z, counter 2
interface A, counter 3
interface B, counter 3
...
interface Z, counter 3
interface A, counter N
interface B, counter N
...
interface Z, counter N
```

To align all responses at the start of a row, avoid performing GetBulkRequests that result in more data than can fit in a single response. This can be accomplished by limiting the max-repetitions depending on the number of repeaters and OIDs, and the size of data returned for each repeater and OID.

4.3.2 Queueing, RTT, and collection performance

The best collection performance is achieved if the SNMP manager keeps the SNMP input queue of the SR OS router filled, but without overflowing it. If maximum performance is required, then the SNMP manager should always have at least two outstanding requests toward the SR OS router: one request that the SR OS router is currently processing (but to which it has not replied yet), and one request that is waiting in the SNMP input queue of the SR OS router.

When the 7750 SR replies to the request, it immediately processes the next request if one is waiting in the input queue.

When the SNMP manager receives the reply, it immediately sends another request to the 7750 SR SNMP input queue.

If the round trip time (RTT) between the SNMP manager and the 7750 SR is significant, the SNMP manager may need to have more than two outstanding requests to maximize collection performance.

The SNMP manager must also avoid sending too many requests at a high rate without waiting for responses. A large number of outstanding requests can cause a backup in the SNMP input queue in SR OS. A backup can cause a long delay in response to the last item in the queue and a timeout on the SNMP manager. It can also cause discards at the SNMP input queue in SR OS.

4.4 Configuration notes

This section describes SNMP configuration restrictions.

4.4.1 General

To avoid management systems attempting to manage a partially booted system, SNMP remains in a shut down state if the configuration file fails to complete during system startup in classic or mixed configuration mode. While shutdown, SNMP gets and sets are not processed. However, notifications are issued if an SNMP trap group has been configured.

To enable SNMP, the portions of the configuration that failed to load must be initialized properly. Use the following command to start SNMP:

- **MD-CLI**

```
configure system management-interface snmp admin-state enable
```

- **classic CLI**

```
configure system snmp no shutdown
```

Use the following command to change the SNMP engine ID:



Caution: If you change the SNMP engine ID, save the current configuration and then reboot. This ensures that previously configured SNMP communities and logger trap-target notify communities are valid for the new engine ID.

- **MD-CLI**

```
configure system management-interface snmp engine-id
```

- **classic CLI**

```
configure system snmp engineID
```

4.5 Configuring SNMP with CLI

This section provides information about configuring SNMP with CLI.

4.5.1 SNMP configuration overview

This section describes how to configure SNMP components which apply to SNMPv1 and SNMPv2c, and SNMPv3 on the router.

4.5.1.1 Configuring SNMPv1 and SNMPv2c

Nokia routers are based on SNMPv3. To use the routers with SNMPv1 and/or SNMPv2c, SNMP community strings must be configured. Three pre-defined access methods are available when SNMPv1 or SNMPv2c access is required. Each access method (**r**, **rw**, or **rwa**) is associated with an SNMPv3 access group that determines the access privileges and the scope of managed objects available. The **community** command is used to associate a community string with a specific access method and the required SNMP version (SNMPv1 or SNMPv2c). The access methods are:

read-only

grants read only access to the entire management structure with the exception of the security area

read-write

grants read and write access to the entire management structure with the exception of the security area

read-write-all

grants read and write access to the entire management structure, including security

If the predefined access groups do not meet your access requirements, then additional access groups and views can be configured. The **usm-community** command is used to associate an access group with an SNMPv1 or SNMPv2c community string. Nokia does not recommend associating a **usm-community** with an SNMP access group that is configured with the **li** (lawful intercept) context.

Use the following command to configure SNMP trap destinations.

```
configure log snmp-trap-group
```

4.5.1.2 Configuring SNMPv3

The SR OS implements SNMPv3. If security features other than the default views are required, you must configure the following:

- configure views
- configure access groups
- configure SNMP users

4.5.2 Basic SNMP security configuration

This section provides information to configure SNMP and an example of a common configuration.

At minimum, you must configure the following for SNMP:

- the community string for SNMPv1 and SNMPv2c

- the following for SNMPv3:
 - view
 - SNMP group
 - access
 - SNMP user

The following example shows configuration of SNMP default views, access groups, and access attempts.

Example: MD-CLI

```
[ex:/configure system security snmp]
A:admin@node-2# info
  access "snmp-ro" context "" security-model snmpv1 security-level no-auth-no-privacy {
    read "no-security"
    notify "no-security"
  }
  access "snmp-ro" context "" security-model snmpv2c security-level no-auth-no-privacy {
    read "no-security"
    notify "no-security"
  }
  access "snmp-rw" context "" security-model snmpv1 security-level no-auth-no-privacy {
    read "no-security"
    write "no-security"
    notify "no-security"
  }
  access "snmp-rw" context "" security-model snmpv2c security-level no-auth-no-privacy {
    read "no-security"
    write "no-security"
    notify "no-security"
  }
  access "snmp-rwa" context "" security-model snmpv1 security-level no-auth-no-
-privacy {
    read "iso"
    write "iso"
    notify "iso"
  }
  access "snmp-rwa" context "" security-model snmpv2c security-level no-auth-no-privacy
{
    read "iso"
    write "iso"
    notify "iso"
  }
  access "snmp-trap" context "" security-model snmpv1 security-level no-auth-no-privacy
{
    notify "iso"
  }
  access "snmp-trap" context "" security-model snmpv2c security-level no-auth-no-privacy
{
    notify "iso"
  }
  attempts {
    count 20
    time 5
    lockout 10
  }
  view "iso" subtree "1" {
    mask "ff"
    type included
  }
  view "no-security" subtree "1" {
    mask "ff"
  }
```

```

    type included
  }
  view "no-security" subtree "1.3.6.1.6.3" {
    mask "ff"
    type excluded
  }
  view "no-security" subtree "1.3.6.1.6.3.10.2.1" {
    mask "ff"
    type included
  }
  view "no-security" subtree "1.3.6.1.6.3.11.2.1" {
    mask "ff"
    type included
  }
  view "no-security" subtree "1.3.6.1.6.3.15.1.1" {
    mask "ff"
    type included
  }
}

```

Example: classic CLI

```

A:node-2>config>system>security>snmp# info detail
-----
    view iso subtree 1
      mask ff type included
    exit
    view no-security subtree 1
      mask ff type included
    exit
    view no-security subtree 1.3.6.1.6.3
      mask ff type excluded
    exit
    view no-security subtree 1.3.6.1.6.3.10.2.1
      mask ff type included
    exit
    view no-security subtree 1.3.6.1.6.3.11.2.1
      mask ff type included
    exit
    view no-security subtree 1.3.6.1.6.3.15.1.1
      mask ff type included
    exit
    access group snmp-ro security-model snmpv1 security-level no-auth-no-
privacy read no-security notify no-security
    access group snmp-ro security-model snmpv2c security-level no-auth-no-
privacy read no-security notify no-security
    access group snmp-rw security-model snmpv1 security-level no-auth-no-
privacy read no-security write no-security notify no-security
    access group snmp-rw security-model snmpv2c security-level no-auth-no-
privacy read no-security write no-security notify no-security
    access group snmp-rwa security-model snmpv1 security-level no-auth-no-
privacy read iso write iso notify iso
    access group snmp-rwa security-model snmpv2c security-level no-auth-no-
privacy read iso write iso notify iso
    access group snmp-trap security-model snmpv1 security-level no-auth-
no-
privacy notify iso
    access group snmp-trap security-model snmpv2c security-level no-auth-
no-privacy notify iso
    attempts 20 time 5 lockout 10

```

4.5.3 Configuring SNMP components

4.5.3.1 Configuring community strings

SNMPv1 and SNMPv2c community options include the community string. The community string defines the relationship between an SNMP manager and agent. The community string acts like a password to allow access to the agent. The access granted with a community string is restricted to the scope of the configured group.

You can specify one or more of the following characteristics associated with the string:

- read-only, read-write, and read-write-all permission for the MIB objects accessible to the community
- the SNMP version, SNMPv1 or SNMPv2c

Default access features are pre-configured by the agent for SNMPv1/SNMPv2c.

Use the commands in the following context to configure the community options:

```
configure system security snmp community
```

Example: MD-CLI

```
[ex:/configure system security snmp]
A:admin@node-2# info
  community "IotIpW28Ls8Q0TIInrJydyer0nvF+U1aq hash2" {
    access-permissions rwa
    version both
  }
  community "X7FnngnQFm3LicdiQLBGibb0pPGzbdp hash2" {
    access-permissions r
    version v2c
  }
  community "yuumEiY8oD40Uo5/FckzYi9Uz0Cc2pke hash2" {
    access-permissions r
    version both
  }
}
```

Example: classic CLI

```
A:node-2>config>system>security>snmp# info
-----
  community "uTdc9j48PBRkxn5DcSjchk" hash2 rwa version both
  community "Lla.RtAyRW2" hash2 r version v2c
  community "r0a159kI0fg" hash2 r version both
-----
```

4.5.3.2 Configuring views

Use the commands in the following context to configure SNMP view options.

```
configure system security snmp view
```

Example: MD-CLI

```
[ex:/configure system security snmp]
```

```
A:admin@node-2# info
view "testview" subtree "1" {
    mask "ff"
}
view "testview" subtree "1.3.6.1.2" {
    mask "ff"
    type excluded
}
```

Example: classic CLI

```
A:node-2>config>system>security>snmp# info
-----
view "testview" subtree "1"
    mask ff
exit
view "testview" subtree "1.3.6.1.2"
    mask ff type excluded
exit
-----
```

4.5.3.3 Configuring access groups

SNMP access group configuration creates an association between an SNMP context, security model, security level, and SNMP views. The access groups can then be used to control SNMP access to the router. Access groups must be configured unless security is limited to the preconfigured access groups and views for SNMPv1 and SNMPv2. The access group is defined by the unique combination of the SNMP context, security model, and security level.

Use the commands in the following context to configure SNMP access groups.

```
configure system security snmp access
```

Example: SNMP access group and view configuration (MD-CLI)

```
[ex:/configure system security snmp]
A:admin@node-2# info
access "testgroup" context "" security-model usm security-level privacy {
    read "testview"
    write "testview"
    notify "testview"
}
view "testview" subtree "1" {
    mask "ff"
}
view "testview" subtree "1.3.6.1.2" {
    mask "ff"
    type excluded
}
```

Example: SNMP access group and view configuration (classic CLI)

```
A:node-2>config>system>security>snmp# info
-----
view "testview" subtree "1"
    mask ff
exit
```



```

view "testview" subtree "1.3.6.1.2"
    mask ff type excluded
    exit
    access group "testgroup" security-model usm security-level privacy read
"testview" write "testview" notify "testview"
-----

```

To deploy user-based SNMPv3, combine SNMP access groups with other SNMP configuration options in the configuration of local users. Use the commands in the following context to configure SNMP access and authentication for a user:

- **MD-CLI**

```
configure system security user-params local-user user
```

- **classic CLI**

```
configure system security user
```

Example: SNMP access and authentication for a user (MD-CLI)

```

[ex:/configure system security user-params local-user user "testuser"]
A:admin@node-2# info
password "password123"
access {
    snmp true
    console
}
console {
    member false
}
snmp {
    group "testgroup"
    authentication {
        authentication-protocol hmac-md5-96
        authentication-key "9Mx3Ejeg0fz5g8oZa049tD/rw2Nlwuvv3H0Uvuppj48= hash2"
        privacy {
            privacy-protocol cfb128-aes-128
            privacy-key "BkkXpC7xTVuZIsUewNJcuyf8Fi0PZJK0oCZ277fRdMY= hash2"
        }
    }
}
}

```

Example: SNMP access and authentication for a user (classic CLI)

```

A:node-2>configure system security user "testuser"
A:node-2>config>system>security>user# info
-----
password "$2y$10$yQPzYQ8B1h.LxUmz3v56M.ekU3S/3V3HNjJ7/4ntrm8B10c2S/G/i"
access snmp
console
    no member "default"
exit
snmp
    authentication hash2 hmac-md5-96 9Mx3Ejeg0fz5g8oZa049tD/
rw2Nlwuvv3H0Uvuppj48= privacy cfb128-aes-128 BkkXpC7xTVuZIsUewNJcuyf8Fi0PZJK0oCZ277fRdMY=
    group "testgroup"
exit
-----

```

**Note:**

Use the following command to generate authentication and privacy keys.

```
tools perform system management-interface snmp generate-key
```

An offline tool can also be used to generate the authentication and privacy keys. In addition to the Nokia Network Services Platform (NSP), which includes the **password2key** tool, several third-party tools are also available for use. For example, **snmpv3-hashgen** in the Python SNMPv3-Hash-Generator package generates the correct keys.

4.5.3.4 Configuring USM communities

User-based security model (USM) community strings associate a community string with an SNMPv3 access group and its view. The access granted with a community string is restricted to the scope of the configured group.

By default, the OS implementation of SNMP uses SNMPv3. However, to implement SNMPv1 and SNMPv2c, USM community strings must be explicitly configured.

Nokia does not recommend associating a **usm-community** with an SNMP access group that is configured with the **li** (lawful intercept) context.

You can associate a community string with an SNMPv3 access group and its view. The access granted with a community string is restricted to the scope of the configured group.

Use the commands in the following context to configure USM community options.

```
configure system security snmp usm-community
```

4.5.3.5 Configuring other SNMP options

Use the commands in the following context to configure SNMP system options such as an SNMP engine ID that uniquely identifies the node, the maximum SNMP packet size generated by the node, and the port for receiving SNMP request messages and sending replies:

- **MD-CLI**

```
configure system management-interface snmp
```

- **classic CLI**

```
configure system snmp
```

The following example shows configuration of the management interface for SNMP.

Example: MD-CLI

```
[ex:/configure system management-interface snmp]
A:admin@node-2# info
  admin-state disable
  engine-id 0000197f0000daf1ff000000
  general-port 161
  packet-size 1500
```

Example: classic CLI

```
A:node-2>config>system>snmp# info detail
-----
shutdown
engineID "0000197f0000daf1ff000000"
packet-size 1500
general-port 161
-----\
```

5 NETCONF

5.1 NETCONF overview

NETCONF is a standardized IETF configuration management protocol specified in RFC 6241, *Network Configuration Protocol (NETCONF)*. It is secure, connection-oriented, and runs on top of the SSHv2 transport protocol as specified in RFC 6242, *Using the NETCONF Configuration Protocol over Secure Shell (SSH)*. NETCONF is an XML-based protocol that can be used as an alternative to CLI or SNMP for managing an SR OS router.

NETCONF uses RPC messaging for communication between a NETCONF client and the NETCONF server running on SR OS. An RPC message and configuration or state data is encapsulated within an XML document. These XML documents are exchanged between a NETCONF client and a NETCONF server in a request/response type of interaction. The SR OS NETCONF interface supports configuration, state and various router operations (for example, reboot). [Figure 16: NETCONF RPC request](#) shows a NETCONF RPC request.

Figure 16: NETCONF RPC request

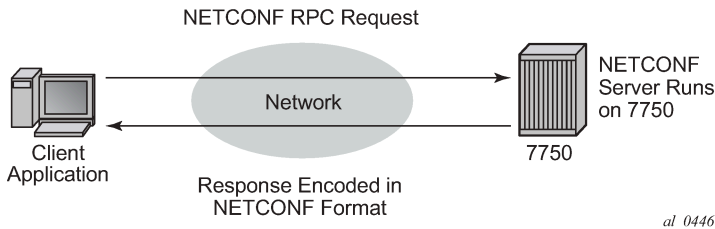

al_0446

NETCONF can be conceptually partitioned into four layers as described in RFC 6241. [Figure 17: NETCONF layers \(RFC 6241\)](#) shows the NETCONF layers.

Figure 17: NETCONF layers (RFC 6241)

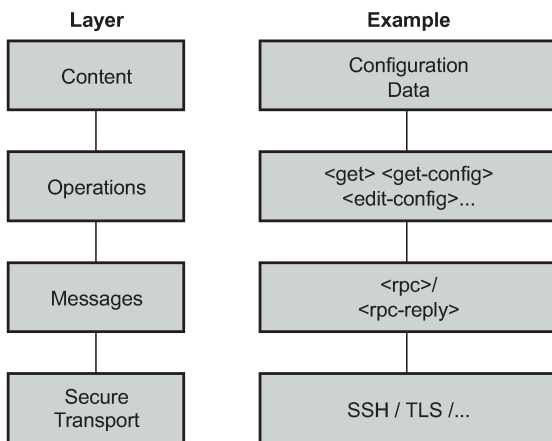

al_0447

5.2 NETCONF in SR OS

Use NETCONF on an SR OS router to perform router management operations such as:

- changing the configuration of the router (using the `<edit-config>` operation)
- reading the configuration of the router (using the `<get-config>` operation, equivalent to the **info** command while in the **configure** branch of the SR OS CLI)
- reading operational status and data using the `<get>` operation (equivalent to the **show** commands in the SR OS CLI, or executing the **info** command while in the state branch of MD-CLI)
- sending notifications on an SR OS router (equivalent to the SR OS log events)
- executing operations equivalent to MD-CLI commands, such as **admin**, **file**, **clear**, **oam**, and **ping**, using the `md-cli-raw-command` request (see [NETCONF operations using the md-cli-raw-command request](#))
- executing some operations (for example, **admin reboot**, **ping**), which are individually modeled as YANG actions and can be called from NETCONF (see [Individually YANG-modeled operations](#))

The SR OS NETCONF server supports both the base:1.1 capability and the base:1.0 capability.

5.2.1 Transport and sessions

SSH transport for NETCONF is supported on TCP port 830 (default) or port 22 with IPv4 or IPv6 in-band in the "Base" routing instance or in a VPRN, or out-of-band in the "Management" routing instance on the CPM Ethernet ports.

NETCONF SSH sessions (the same as CLI, SCP, and SFTP sessions) are subject to any configurable and non-configurable session limits; for example, `inbound-max-sessions`.

Both the SSH server and NETCONF protocol must be enabled in the router configuration to use NETCONF.

NETCONF sessions do not time out automatically and are not subject to the CLI session timeout. Operators can disconnect sessions manually using the **admin disconnect** command.

A client establishing a NETCONF session must log in to the router so user accounts must exist for NETCONF on SR OS. An access type **netconf** is provided. For access to the Nokia SR OS YANG data models, only **netconf** access is necessary.

Authentication using the local user database is supported for NETCONF users. You must configure the **access netconf** statement in the local user record. Also, NETCONF runs over SSH, and SSH supports RADIUS/TACACS+ user authentication.

- **RADIUS**

Use the following command to enable **access netconf** in the user template:

- **MD-CLI**

```
configure system security aaa user-template user-template-name radius-default
```

- **classic CLI**

```
configure system security user-template radius_default
```

Use the following command to enable **use-default-template**:

– **MD-CLI**

```
configure system security aaa remote-servers radius use-default-template
```

– **classic CLI**

```
configure system security radius use-default-template
```

The RADIUS server must also send the Timetra-Access VSA with a value that includes "netconf" access, for example, "Timetra-Access = netconf" or "Timetra-Access = 15".

• **TACACS+**

Use the following command to enable **access tacplus** in the user template:

– **MD-CLI**

```
configure system security aaa user-template user-template-name tacplus-default
```

– **classic CLI**

```
configure system security user-template tacplus_default
```

Use the following command to enable **use-default-template**:

– **MD-CLI**

```
configure system security aaa remote-servers tacplus use-default-template
```

– **classic CLI**

```
configure system security tacplus use-default-template
```

Authorization is supported for configuration and state elements in NETCONF. The local, RADIUS, or TACACS+ authorization CLI rules are translated and applied to NETCONF requests to modify or display configuration or state data.

5.2.2 Databases and URLs

SR OS supports several databases, including the following standard databases:

- <running>
- <candidate>
- <startup>
- <intended>
- <operational>

Some NETCONF functions use data from <url> locations.

For additional details about databases, see [Databases and regions](#).

The supported databases can be obtained through the "/yang-library" state data model that contains a list of supported databases, as defined in RFC 8525.

The following datastores are not available unless support for the NMDA was enabled (see [NMDA support](#)):

- <intended>
- <operational>

The :candidate capability is advertised in the SR OS NETCONF server <hello> as:

```
<capability>urn:ietf:params:netconf:capability:candidate:1.0</capability>
```

Configuration changes (using the Nokia SR OS YANG data models) made to the <candidate> datastore take effect after a successful <commit> operation.

The <intended> datastore is a read-only representation of the configuration after configuration transformations (such as configuration group expansion) to the <running> datastore are performed.

The <operational> datastore is a read-only representation of the elements the SR OS is using. This includes all configuration (including configuration transformations) and all state information.

The <startup> datastore and <url> can only be used with <copy-config> and <delete-config> and are not supported with any other operations (including <edit-config>, <get-config>, <get>, <validate>, and so on).

The :startup capability is advertised in the SR OS NETCONF server <hello> as:

```
<capability>urn:ietf:params:netconf:capability:startup:1.0</capability>
```

The <url> supports the same options as CLI <file-url>: local urls (CF) and remote urls (FTP and TFTP).

The :url capability is advertised in the SR OS NETCONF server <hello> as:

```
<capability>urn:ietf:params:netconf:capability:url:1.0?scheme=ftp,tftp,file</capability>
```

The following examples show the format of each URL scheme:

- <url>ftp://name:passwd@IP_ADDRESS/myfiles/myfile.cfg</url>
- <url>tftp://name:passwd@IP_ADDRESS/myfiles/myfile.cfg</url>
- <url>file:///cf3:/myfiles/myfile.cfg</url>
- <url>cf3:/myfiles/myfile.cfg</url>



Note: In the examples, "///" is used to indicate the file URL. Also, the "file://localhost/..." format is not supported.

BOF (Boot Options File) is a separate configuration region, which can be configured over NETCONF using the Nokia SR OS YANG models.

Debug is a separate configuration region, which can be configured over NETCONF using the Nokia SR OS YANG models.

Lawful Intercept (LI) is a separate configuration region, which can be configured over NETCONF using the Nokia SR OS YANG models (including configuring any LI log-ids needed to subscribe to and receive LI NETCONF notifications). The same user permissions apply using NETCONF as with MD-CLI (that is, only LI users can access LI data).

5.2.2.1 Operational datastore

The <operational> datastore is a read-only representation of the elements that the SR OS is using. This includes all configuration (including configuration transformations) and all state information.

The <operational> datastore is only accessible over NETCONF and requires that NMDA support is enabled. To obtain <operational> datastore information, use the <get-data> RPC.

Example: Obtaining information from the <operational> datastore using the <get-data> RPC

```
<rpc message-id="example" xmlns="urn:ietf:params:xml:ns:netconf:base:1.0">
  <get-data xmlns="urn:ietf:params:xml:ns:yang:ietf-netconf-nmda" xmlns:ds=
"urn:ietf:params:xml:ns:yang:ietf-datastores">
    <datastore>ds:operational</datastore>
  </get-data>
</rpc>
]]>]]>
```

The <get-data> RPC performed on the <operational> datastore can be extended with the **with-origin** option to detail the origin of each configuration node, excluding non-presence containers.

The following rules define the origin:

- YANG non-presence containers do not have an origin.
- The origin for system-provisioned YANG lists that were not explicitly configured and for YANG leafs in these lists is **system**.
- The origin for explicitly configured YANG containers, lists, and leafs (visible in MD-CLI using the **info intended** command) is **intended**.
- The origin for YANG containers, lists, and leafs that are not system-provisioned and not explicitly configured is **default**.

Example: <get-data> RPC usage with the with-origin option

```
<rpc message-id="example" xmlns="urn:ietf:params:xml:ns:netconf:base:1.0">
  <get-data xmlns="urn:ietf:params:xml:ns:yang:ietf-netconf-nmda" xmlns:ds=
"urn:ietf:params:xml:ns:yang:ietf-datastores">
    <datastore>ds:operational</datastore>
    <with-origin/>
  </get-data>
</rpc>
]]>]]>
```

5.2.3 NETCONF operations and capabilities

Each RPC request can only contain one operation. The following table summarizes the protocol operations and capabilities supported on the 7450 ESS, 7750 SR, and 7950 XRS.

Table 24: Summary of operations and capabilities

| Support | Capabilities | Operations |
|--------------------------|--------------|---|
| Base Protocol Operations | — | <ul style="list-style-type: none"> • <get> |

| Support | Capabilities | Operations |
|-----------------------|------------------------------------|--|
| | | <ul style="list-style-type: none"> • <get-config> • <edit-config> • <copy-config> • <delete-config> • <lock> • <unlock> • <close-session> • <kill-session> |
| RFC 6241 ⁷ | writable-running capability | — |
| | candidate configuration capability | <ul style="list-style-type: none"> • <commit> • <discard-changes> |
| | confirmed commit | <cancel-commit> |
| | validate | <validate> |
| | startup | — |
| | URL | — |
| | rollback-on-error | — |
| RFC 6243 | with-defaults | — |
| RFC 5277 | notification | <create-subscription> |
| | interleave | — |
| RFC 6022 | ietf-network-monitoring | <get-schema> |
| RFC 8525 | ietf-yang-library | — |
| RFC 8526 | — | <get data> |
| RFC 7950 | — | <action> ⁸ |

The following table lists the supported NETCONF operations and arguments.

⁷ Optional capabilities defined in RFC 6241 are supported.

⁸ YANG 1.1 defines an [<action>](#) element. See section [Individually YANG-modeled operations](#) for details of SR OS support of actions.

Table 25: Supported standard NETCONF operations and arguments

| Operation | Arguments |
|---------------------|---|
| get-config | source/[configuration-region] [filter] [format] |
| edit-config | target/[configuration-region] [default-operation] [test-option] [error-option] config |
| copy-config | target/[configuration-region] source/[configuration-region] |
| delete-config | target |
| lock | target/[configuration-region] |
| unlock | target/[configuration-region] |
| get | [filter] [configuration-region] [format] |
| close-session | — |
| kill-session | session-id |
| discard-changes | [configuration-region] |
| validate | source/[configuration-region] |
| commit | [confirmed] [confirm-timeout] [comment] [persist] [configuration-region] |
| cancel-commit | [persist-id] |
| create-subscription | [stream] [startTime] [stopTime] |

| Operation | Arguments |
|------------|---|
| get-schema | identifier [version] [format] |
| get-data | datastore [subtree-filter] [max-depth] [with-defaults] [configuration-region] [format] [with-origin] [config-filter] |
| action | YANG 1.1 defines an <action> element. See section Individually YANG-modeled operations for details of SR OS support of actions. |



Note: Bracketed arguments are optional. The X/[configuration-group] means that the [configuration-group] can only be used as a child of X.

The following table lists protocol operations and level of support in SR OS NETCONF servers, and limitations, if any, in the current implementation.

Table 26: Protocol operations and level of support in Nokia SR OS NETCONF servers

| Protocol operation | Example | Supported | Notes |
|--------------------|--|-----------|---|
| get-config | <pre><?xml version="1.0" encoding="UTF-8"?> <rpc message-id="101" xmlns="urn:ietf:params:xml:ns:netconf:base:1.0"> <get-config> <source> <running/> </source> </get-config> </rpc></pre> | Yes | To use the get-config operation, the user must belong to a command-authorization profile with get-config enabled under netconf base-op-authorization ⁹ . |

⁹ Enable the command in the following context:

- **MD-CLI**

```
configure system security aaa local-profiles profile netconf base-op-authorization
```

- **classic CLI**

```
configure system security profile netconf base-op-authorization
```

| Protocol operation | Example | Supported | Notes |
|--------------------|---|-----------|---|
| | <code>]]>]]></code> | | If present, configuration annotations are encoded with the <code>nokia-attr:comment</code> attribute. |
| | <code><source> <startup/> </source></code> | No | — |
| | <code><source> <candidate/> </source></code> | Yes | — |
| | <code><source> <config/> </source></code> | No | — |
| | <code><source> <url/> </source></code> | No | — |
| | <code><?xml version="1.0" encoding="UTF-8"?> <rpc message-id="101" xmlns="urn:ietf:params:xml:ns:netconf:base:1.0"> <get-config> <source><running/></source> <filter type="subtree"> </filter> </get-config> </rpc>]]>]]></code> | Yes | A <code><filter></code> is an optional argument. All subtree filters are supported in SR OS except for "attribute match expressions". |
| | <code><filter type="xpath"> </filter></code> | No | — |
| | <code><source> <configuration-region>...</ configuration-region xmlns= "urn:nokia.com:sros:ns:yang:sr:ietf- netconf-augments"> </source></code> | Yes | Optional. Specify "bof", "configure", "debug", or "li". The default, if not specified, is "configure". A datastore must be specified inside the <code><source></code> if the <code><configuration-region></code> is used. |
| get | <code><?xml version="1.0" encoding="UTF-8"?> <rpc message-id="101" xmlns="urn:ietf:params:xml:ns:netconf:ba</code> | Yes | Retrieves both configuration and state data if in XML content layer. |

| Protocol operation | Example | Supported | Notes |
|--------------------|---|-----------|--|
| | <pre>se:1.0"> <get/> </rpc>]]>]]></pre> | | To use the get operation, the user must belong to a command-authorization profile with get enabled under netconf base-op-authorization ⁹ . If present, configuration annotations are encoded with the nokia-attr:comment attribute. |
| | <pre><?xml version="1.0" encoding="UTF-8"?> <rpc message-id="101" xmlns="urn:ietf:params:xml:ns:netconf:base:1.0"> <get> <filter type="subtree"> </filter> </get> </rpc>]]>]]></pre> | Yes | A <filter> is an optional argument. Subtree filters are supported except for "attribute match expressions". |
| | <pre><filter type="xpath"> </filter></pre> | No | — |
| | <pre><configuration-region xmlns= "urn:nokia.com:sros:ns:yang:sr:ietf- netconf-augments">...</ configuration-region></pre> | Yes | Optional. Specify "bof", "configure", "debug", or "li". The default, if not specified, is "configure". |
| edit-config | <pre><?xml version="1.0" encoding="UTF-8"?> <rpc message-id="101" xmlns="urn:ietf:params:xml:ns:netconf:base:1.0"> <edit-config> <target/> <default-operation/> <test-option/> <error-option/> <config/> </edit-config> </rpc>]]>]]></pre> | Yes | <default-operation>, <test-option>, and <error-option> are optional arguments. To use the edit-config operation, the user must belong to a command-authorization profile with edit-config enabled under netconf base-op-authorization ⁹ . Configuration annotations may be encoded with the nokia-attr:comment attribute to add, change, or delete the annotations. |
| | <pre><target> <url/></pre> | No | — |

| Protocol operation | Example | Supported | Notes |
|--------------------|---|-----------|--|
| | <code></target></code> | | |
| | <code><target> <startup/> </target></code> | No | — |
| | <code><target> <candidate> </target></code> | Yes | — |
| | <code><target><running></target></code> | No | — |
| | <code><default-operation>merge</default-operation></code> | Yes | Default |
| | <code><default-operation>none</default-operation></code> | Yes | An operation of "none" (inherited or direct) on a leaf node that does not exist in the data model causes SR OS to return an error with an <error-tag> value of "data-missing". |
| | <code><default-operation>replace</default-operation></code> | Yes | — |
| | <code><test-option>test-then-set</test-option></code> | Yes | — |
| | <code><test-option>set</test-option></code> | Yes | — |
| | <code><test-option>test-only</test-option></code> | Yes | — |
| | <code><error-option>continue-on-error</error-option></code> | No | — |
| | <code><error-option>rollback-on-error</error-</code> | Yes | — |

| Protocol operation | Example | Supported | Notes |
|--------------------|---|-----------|---|
| | <code>option></code> | | |
| | <code><error-option>stop-on-error</error-option></code> | Yes | Default. The stop-on-error option can be specified but behaves the same as a rollback-on-error . |
| | <code><target> <configuration-region xmlns= "urn:nokia.com:sros:ns:yang:sr:ietf- netconf-augments">...</ configuration-region> </target></code> | Yes | Optional. Specify "bof", "configure", "debug", or "li". The default, if not specified, is "configure". |
| close-session | <code><?xml version="1.0" encoding="UTF-8"?> <rpc message-id="101" xmlns="urn:ietf:params:xml:ns:netconf:base:1.0"> <close-session/> </rpc>]]>]]></code> | Yes | When a session is closed, any locks held are released and the session is terminated. Any pending RPC requests are discarded. To use the close-session operation, the user must belong to a command-authorization profile with close-session enabled under netconf base-op-authorization ⁹ . |
| commit | <code><?xml version="1.0" encoding="UTF-8"?> <rpc message-id="101" xmlns="urn:ietf:params:xml:ns:netconf:base:1.0"> <commit/> </rpc>]]>]]></code> | Yes | When commit is issued, any configuration stored in the <candidate> datastore is written to the running configuration unless the device is locked by a NETCONF client or <running> datastore is locked by any other NETCONF session. The startup configuration is also written if netconf auto-config-save is configured, in classic CLI in the configure system context and in MD-CLI in the system management-interface context. To use the commit operation, the user must belong to a command-authorization profile with commit enabled under netconf base-op-authorization ⁹ . |
| | <code><commit><comment>Comment entered</code> | Yes | Optional. |

| Protocol operation | Example | Supported | Notes |
|--------------------|--|-----------|--|
| | <code>over NETCONF.</comment></commit></code> | | Specifies a comment in the commit history. |
| | <code><commit><confirmed/></commit></code> | Yes | Optional. Can only be used with the "configure" (default) <configuration-region>. |
| | <code><commit> <confirmed/> <confirm-timeout/> </commit></code> | Yes | Optional. Can only be used with the "configure" (default) <configuration-region>. |
| | <code><commit> <confirmed/> <confirm-timeout/> <persist/> </commit></code> | Yes | Optional. Can only be used with the "configure" (default) <configuration-region>. |
| | <code><commit> <confirmed/> <confirm-timeout/> <persist/> <persist-id/> </commit></code> | Yes | Optional. Can only be used with the "configure" (default) <configuration-region>. |
| | <code><commit> <configuration-region xmlns= "urn:nokia.com:sros:ns:yang:sr:ietf- netconf-augments">...</ configuration-region> </commit></code> | Yes | Optional. Specify "bof", "configure", "debug" or "li". The default, if not specified, is "configure". |
| cancel-commit | <code><?xml version="1.0" encoding="UTF-8"?> <rpc message-id="101" xmlns="urn:ietf:params:xml:ns:netconf:base:1.0"> <cancel-commit/> </rpc> <]]></></code> | Yes | Can only be used with the "configure" (default) <configuration-region>. To use the cancel commit operation, the user must belong to a command-authorization profile with cancel-commit enabled under netconf base-op-authorization ⁹ . |
| | <code><cancel-commit><persist-id>...<persist-id/> </cancel-commit></code> | Yes | Optional. When a <commit> <persist> is used, the value of a <cancel-commit> <persist-id> must be |

| Protocol operation | Example | Supported | Notes |
|--------------------|--|-----------|---|
| | | | equal to the value used in the <code><commit></code> <code><persist></code> . |
| copy-config | <pre><?xml version="1.0" encoding="UTF-8"?> <rpc message-id="101" xmlns:nc= "urn:ietf:params:xml:ns:netconf: base:1.0"> <copy-config> <target/> <source/> </copy-config> </rpc>]]>]]></pre> | Yes | <p>The <code><copy-config></code> operation is supported for specific combinations of source and target datastores.</p> <p>To use the copy-config operation, the user must belong to a command-authorization profile with copy-config enabled under netconf base-op-authorization⁹.</p> <p>When the specified <code><configuration-region></code> is "li", the <code><source><running/></code> to <code><target><startup/></code> becomes the only valid <code><copy-config></code> combination.</p> |
| | <pre><target><running/></target></pre> | No | The running datastore cannot be a <code><target></code> for a <code><copy-config></code> . |
| | <pre><source><running/></source> <target><candidate/></target></pre> | No | Use <code><discard-changes></code> . |
| | <pre><source><running/></source> <target><startup/></target></pre> | Yes | <p>Equivalent to admin save.</p> <p>If NETCONF auto-config-save is not enabled, this should be issued after every <code><commit></code> for the change to be persistent over a reboot.</p> <p>An index file is also saved in classic management-interface configuration-mode if persist on is configured in the BOF.</p> |
| | <pre><source><running/></source> <target><url/></target></pre> | Yes | <p>Equivalent to admin save file-url.</p> <p>An index file is also saved in classic management-interface configuration-mode if persist on is configured in the BOF.</p> |
| | <pre><source><startup/></source></pre> | Yes | — |

| Protocol operation | Example | Supported | Notes |
|--------------------|--|-----------|--|
| | <code><target><candidate/></target></code> | | |
| | <code><source><startup/></source> <target><url/></target></code> | Yes | Supported if both source and target are not remote URLs. Only configuration changes are saved; for example, an index file is not saved in classic management-interface configuration-mode even if persist on is configured in the BOF. |
| | <code><source><startup/></source> <target><running/></target></code> | No | — |
| | <code><source><candidate/></source> <target><startup/></target></code> | Yes | — |
| | <code><source><candidate/></source> <target><url/></target></code> | Yes | — |
| | <code><source><candidate/></source> <target><running/></target></code> | No | Use <code><commit></code> instead. |
| | <code><source><url/></source> <target><running/></target></code> | No | — |
| | <code><source><url/></source> <target><candidate/></target></code> | Yes | Supported in model-driven configuration mode only. |
| | <code><source><url/></source> <target><startup/></target></code> | Yes | Supported if both source and target are not remote URLs. Only configuration changes are saved; for example, an index file is not saved in classic management-interface configuration-mode even if persist on is configured in the BOF. |
| | <code><source><url/></source></code> | Yes | Supported if both source and target are not remote URLs. |

| Protocol operation | Example | Supported | Notes |
|--------------------|---|-----------|--|
| | <pre><target><url/></target></pre> | | |
| | <pre><target><config/></target></pre> | No | — |
| | <pre><source><config/></source> <target><candidate/></target></pre> | Yes | — |
| | <pre><source><config/></source> <target><startup/></target></pre> | Yes | — |
| | <pre><source><config/></source> <target><url/></target></pre> | Yes | — |
| | <pre><target> <configuration-region xmlns= "urn:nokia.com:sros:ns:yang:sr:ietf- netconf-augments"> ... </configuration-region> </target></pre> | Yes | Optional. Specify "bof", "configure", "debug", or "li". The default, if not specified, is "configure". Not supported in mixed mode. |
| | <pre><source> <configuration-region xmlns= "urn:nokia.com:sros:ns:yang:sr:ietf- netconf-augments"> ... </configuration-region> </source></pre> | Yes | Optional. Specify "bof", "configure", "debug", or "li". The default, if not specified, is "configure". Not supported in mixed mode. |
| kill-session | <pre><?xml version="1.0" encoding="UTF-8"?> <rpc message-id="101" xmlns="urn:ietf:params:xml:ns:netconf:base:1.0"> <kill-session> <session-id/> </kill-session> </rpc>]]>]]></pre> | Yes | A NETCONF session cannot kill itself. A NETCONF session cannot kill a non-NETCONF session. When a session is killed, any operations pending in that session are discarded. Any locks held by that session are released. Only a NETCONF user that belongs to a command-authorization profile with kill-session enabled under netconf |

| Protocol operation | Example | Supported | Notes |
|--------------------|---|-----------|---|
| | | | base-op-authorization ⁹ , can kill a NETCONF session. |
| lock | <pre><?xml version="1.0" encoding="UTF-8"?> <rpc message-id="101" xmlns="urn:ietf:params:xml:ns:netconf:base:1.0"> <lock> <target/> </lock> </rpc>]]>]]></pre> | Yes | Only a NETCONF user that belongs to a command-authorization profile with lock enabled under netconf base-op-authorization ⁹ , can lock a datastore. |
| | <pre><target><candidate/></target></pre> | Yes | Locking the <candidate> datastore implicitly locks both the <running> and <candidate> datastores. |
| | <pre><target><running/></target></pre> | Yes | Locking the <running> datastore locks both the <running> and <candidate> datastores. |
| | <pre><target><startup/></target></pre> | No | — |
| | <pre><target><url/></target></pre> | No | — |
| | <pre><target> <configuration-region xmlns= "urn:nokia.com:sros:ns:yang:sr:ietf- netconf-augments">...</ configuration-region> </target></pre> | Yes | Optional. Specify "bof", "configure", "debug", or "li". The default, if not specified, is "configure". |
| unlock | <pre><?xml version="1.0" encoding="UTF-8"?> <rpc message-id="101" xmlns="urn:ietf:params:xml:ns:netconf:base:1.0"> <unlock> <target/> </unlock> </rpc>]]>]]></pre> | Yes | Only a NETCONF user that belongs to a command-authorization profile with lock enabled under netconf base-op-authorization ⁹ , can unlock a datastore. (note that lock authorization also gives unlock authorization) A datastore lock is unlocked when: <ul style="list-style-type: none"> • using <unlock> • disconnecting a NETCONF session (from CLI using |

| Protocol operation | Example | Supported | Notes |
|--------------------|--|-----------|---|
| | | | <p>the admin disconnect command, by using Ctrl-c, by performing <kill-session>, or by performing <close-session>)</p> <p>Upon unlocking/disconnecting a NETCONF session that had acquired a datastore lock, SR OS:</p> <ul style="list-style-type: none"> releases the lock discards any "uncommitted" changes |
| | <code><target><candidate/></target></code> | Yes | — |
| | <code><target><running/></target></code> | Yes | — |
| | <code><target><startup/></target></code> | No | — |
| | <code><target><url/></target></code> | No | — |
| | <pre><target> <configuration-region xmlns= "urn:nokia.com:sros:ns:yang:sr:ietf- netconf-augments"> ... </configuration-region> </target></pre> | Yes | Optional. Specify "bof", "configure", "debug", or "li". The default, if not specified, is "configure". |
| validate | <pre><?xml version="1.0" encoding="UTF-8"?> <rpc message-id="101" xmlns:nc= "urn:ietf:params:xml:ns:netconf: base:1.0"> <validate> <source/> </validate> </rpc>]]>]]></pre> | Yes | <p>XML content layer only.</p> <p>Only syntax validation is performed.</p> <p>If more than one error exists, SR OS returns multiple errors.</p> <p>No semantic validation is performed.</p> <p>To use the validate operation, the user must belong to a command-authorization profile with validate</p> |

| Protocol operation | Example | Supported | Notes |
|--------------------|---|-----------|---|
| | | | enabled under netconf base-op-authorization ⁹ . |
| | <code><source><candidate/></source></code> | Yes | — |
| | <code><source><running/></source></code> | No | — |
| | <code><source><startup/></source></code> | No | — |
| | <code><source><url/></source></code> | No | — |
| | <code><source><config/></source></code> | No | — |
| | <pre> <source> <configuration-region xmlns= "urn:nokia.com:sros:ns:yang:sr:ietf- netconf-augments"> ... </configuration-region> </source> </pre> | Yes | Optional. Specify "bof", "configure", "debug", or "li". The default, if not specified, is "configure". |
| delete-config | <pre> <?xml version="1.0" encoding="UTF-8"?> <rpc message-id="101" xmlns:nc= "urn:ietf:params:xml:ns:netconf: base:1.0"> <delete-config> <target/> </delete-config> </rpc> </pre> | Yes | To use the delete-config operation, the user must belong to a command-authorization profile with delete-config enabled under netconf base-op-authorization ⁹ . |

| Protocol operation | Example | Supported | Notes |
|---------------------|--|-----------|--|
| | <pre>]]>]]></pre> | | |
| | <pre><target><startup/></target></pre> | Yes | — |
| | <pre><target><url/></target></pre> | Yes | — |
| | <pre><target><running/></target></pre> | No | — |
| | <pre><target><candidate/></target></pre> | No | — |
| discard-changes | <pre><?xml version="1.0" encoding="UTF-8"?> <rpc message-id="101" xmlns:nc= "urn:ietf:params:xml:ns:netconf: base:1.0"> <discard-changes/> </rpc>]]>]]></pre> | Yes | To use the discard-changes operation, the user must belong to a command-authorization profile with discard-changes enabled under netconf base-op-authorization ⁹ . |
| | <pre><discard-changes> <configuration-region xmlns= "urn:nokia.com:sros:ns:yang:sr:ietf- netconf-augments">...</ configuration-region> </discard-changes></pre> | Yes | Optional. Specify "bof", "configure", "debug", or "li". The default, if not specified, is "configure". |
| create-subscription | <pre><?xml version="1.0" encoding="UTF-8"?> <rpc message-id="101" xmlns:nc= "urn:ietf:params:xml:ns:netconf: base:1.0"> <create-subscription/> </rpc>]]>]]></pre> | Yes | To use the create-subscription operation, the user must belong to a command-authorization profile with create-subscription enabled under netconf base-op-authorization ⁹ . The configuration of base-op-authorization create-subscription is not pre-emptive, which means it is checked only at the time of the initial subscription. Configuration changes to the base-op-authorization do not cancel any in-progress subscriptions and operators who |

| Protocol operation | Example | Supported | Notes |
|--------------------|---|-----------|---|
| | | | successfully subscribed continue to receive messages. |
| | <code><create-subscription><stream/></create-subscription></code> | Yes | Optional |
| | <code><create-subscription><startTime/></create-subscription></code> | Yes | Optional |
| | <code><create-subscription><stopTime/></create-subscription></code> | Yes | Optional |
| | <code><create-subscription><filter/></create-subscription></code> | No | Optional |
| get-schema | <pre><?xml version="1.0" encoding="UTF-8"?> <rpc message-id="101" xmlns="urn:ietf:params:xml:ns:netconf:base:1.0"> <get-schema xmlns= "urn:ietf:params:xml:ns:yang:ietfnetconf-monitoring"> </get-schema> </rpc>]]>]]></pre> | Yes | To use the get-schema operation, the user must belong to a command-authorization profile with get-schema enabled under netconf base-op-authorization ⁹ . |
| | <code><get-schema><identifier/></get-schema></code> | Yes | Mandatory |
| | <code><get-schema><version/></get-schema></code> | Yes | Optional |
| | <code><get-schema><format/></get-schema></code> | Yes | Optional |
| get-data | <pre><?xml version="1.0" encoding="UTF-8"?> <rpc message-id="101" xmlns="urn:ietf:params:xml:ns:netconf:base:1.0"> <get-data> </get-data> </rpc></pre> | Yes | To use the get-data operation, the user must belong to a command-authorization profile with get-data enabled under netconf base-op-authorization ⁹ . |

| Protocol operation | Example | Supported | Notes |
|--------------------|--|-----------|--|
| | <code>]]>]]></code> | | |
| | <code><get-data><datastore/></get-data></code> | Yes | Mandatory. The "startup" cannot be used. |
| | <code><get-data><subtree-filter/></get-data></code> | Yes | Optional |
| | <code><get-data><max-depth/></get-data></code> | Yes | Optional |
| | <code><get-data><config-filter/></get-data></code> | Yes | Optional Specify true or false: <ul style="list-style-type: none"> • true returns configuration nodes only • false returns nodes marked as config false in YANG (usually state information) only The absence of the <code><config-filter></code> option returns both. |
| | <code><get-data><origin-filters/></get-data></code> | No | Optional |
| | <code><get-data><with-origin/></get-data></code> | Yes | Optional. To use this option the datastore must be "operational". |
| | <code><get-data><with-defaults/></get-data></code> | Yes | Optional |
| | <code><get-data><nmdaaug:with-managed/></get-data></code> | Yes | Optional. To use this option the datastore must be "operational". |
| | <code><get-data> <nmdaaug:managed-filter> </nmdaaug:managed-filter> </get-data></code> | Yes | Optional. To use this option the datastore must be "operational". |
| | <code><get-data><xpath-filter/></get-data></code> | No | Optional |
| | <code><get-data> <configuration-region xmlns= "urn:nokia.com:sros:ns:yang:sr:ietf- netconf-augments"> </configuration-region></code> | Yes | Optional. Specify "bof", "configure", "debug", or "li". The default, if not specified, is "configure". |

| Protocol operation | Example | Supported | Notes |
|--------------------|--|-----------|---|
| | <code></get-data></code> | | |
| action | <pre><?xml version="1.0" encoding="UTF-8"?> <rpc message-id="101" xmlns= "urn:ietf:params:xml:ns:netconf:base:1.0"> <action xmlns= "urn:ietf:params:xml:ns:yang:1"> <admin xmlns= "urn:nokia.com:sros:ns:yang:sr:oper- admin"> <redundancy> <synchronize> <configuration/> </synchronize> </redundancy> </admin> </action> </rpc>]]>]]></pre> | Yes | YANG 1.1 defines an <action> element. See section Individually YANG-modeled operations for details of SR OS support of actions. |

5.2.3.1 <get>

A <get> request can retrieve both the configuration and state data.

If any nodes from the configure tree are included in a <get> request filter then, at minimum, the <configure> tag must contain a namespace. If the namespace is not specified, SR OS returns an error.

A <get> request is first analyzed for syntax errors before any execution starts. If a syntax error is found, a single global <rpc-error> for the entire request is sent in the reply.

Responses are provided for each item in the request until the first item with an error is found. The item with an error has a <response> tag containing some error information, followed by an <rpc-error> tag (and sub-tags). The reply is then returned, and subsequent items are not executed.

The <rpc-error> for an individual item (that is, for a non-syntax error) is after the </response> information and not inside the <response>.

See the [<get-config>](#) section for details about subtree filtering support.

To retrieve the BOF configuration, the "bof" <configuration-region> must be specified within the <get> RPC. For example:

```
<?xml version="1.0" encoding="UTF-8"?>
<rpc message-id="101" xmlns="urn:ietf:params:xml:ns:netconf:base:1.0">
  <get>
    <configuration-region xmlns="urn:nokia.com:sros:ns:yang:sr:ietf-netconf-augments">
      bof
    </configuration-region>
    <filter>
      <bof xmlns="urn:nokia.com:sros:ns:yang:sr:bof-conf">
        </bof>
      </filter>
    </get>
  </rpc>
]]>]]>
```

To retrieve the debug configuration, the "debug" <configuration-region> must be specified within the <get> RPC. For example:

```
<?xml version="1.0" encoding="UTF-8"?>
<rpc message-id="101" xmlns="urn:ietf:params:xml:ns:netconf:base:1.0">
  <get>
    <configuration-region xmlns="urn:nokia.com:sros:ns:yang:sr:ietf-netconf-augments">
      debug
    </configuration-region>
    <filter>
      <debug xmlns="urn:nokia.com:sros:ns:yang:sr:debug-conf">
      </debug>
    </filter>
  </get>
</rpc>
]]>]]>
```

To retrieve the LI configuration, the "li" <configuration-region> must be specified within the <get> RPC. For example:

```
<get>
  <configuration-region xmlns="urn:nokia.com:sros:ns:yang:sr:ietf-netconf-augments">
    li
  </configuration-region>
  <filter>
    <li xmlns="urn:nokia.com:sros:ns:yang:sr:li-conf">
    </li>
  </filter>
</get>
```

When a <configuration-region> is not specified, the <configuration-region> (that is, the main non-LI configuration region) is considered to be "configure" by default.

When a mismatched namespace or <configuration-region> combination is specified, SR OS returns an empty <data>.

See [Table 26: Protocol operations and level of support in Nokia SR OS NETCONF servers](#) for more details.

If present, configuration annotations are encoded with the nokia-attr:comment attribute. In the following example, **configure system name** is annotated with the comment "This is a comment on the system name." in the RPC reply:

```
<?xml version="1.0" encoding="UTF-8"?>
<rpc-reply message-id="101" xmlns="urn:ietf:params:xml:ns:netconf:base:1.0">
  <data>
    <configure xmlns="urn:nokia.com:sros:ns:yang:sr:conf" xmlns:nokia-attr=
"urn:nokia.com:sros:ns:yang:sr:attributes">
      <system>
        <name nokia-attr:comment="This is a comment on the system name."> node2</name>
      </system>
    </configure>
  </data>
</rpc-reply>
```

The optional proprietary <format> argument is supported. See [Output format selection](#) for more information.

See the following sections for examples of <get> request and response messages:

- [Namespace specified in <configure> tag](#)

- [Namespace error in <configure> tag](#)
- [Namespace specified in <state> tag](#)
- [Namespace error in <state> tag](#)
- [Output format tag](#)

5.2.3.1.1 Namespace specified in <configure> tag

The following example shows a <configure> tag that contains a namespace.

```
<?xml version="1.0" encoding="UTF-8"?>
<rpc message-id="101" xmlns="urn:ietf:params:xml:ns:netconf:base:1.0">
  <get>
    <filter>
      <configure xmlns="urn:nokia.com:sros:ns:yang:sr:conf">
      </configure>
    </filter>
  </get>
</rpc>
]]>]]>
```

The following example shows the reply, which returns no errors.

```
<?xml version="1.0" encoding="UTF-8"?>
<rpc-reply message-id="101" xmlns="urn:ietf:params:xml:ns:netconf:base:1.0">
  <data>
    <configure xmlns="urn:nokia.com:sros:ns:yang:sr:conf" xmlns:nokia-attr="urn:nokia.com:sros:ns:yang:sr:attributes">
    </configure>
  </data>
</rpc-reply>
]]>]]>
```

5.2.3.1.2 Namespace error in <configure> tag

The following example shows a <configure> tag that does not contain a namespace.

```
<?xml version="1.0" encoding="UTF-8"?>
<rpc message-id="101" xmlns="urn:ietf:params:xml:ns:netconf:base:1.0">
  <get>
    <filter>
      <configure>
        <python xmlns="urn:nokia.com:sros:ns:yang:sr:conf-python">
        </python>
      </configure>
    </filter>
  </get>
</rpc>
]]>]]>
```

The following example shows the reply, which returns SR OS errors.

```
<?xml version="1.0" encoding="UTF-8"?>
<rpc-reply message-id="101" xmlns="urn:ietf:params:xml:ns:netconf:base:1.0">
  <rpc-error>
    <error-type>protocol</error-type>
```

```

    <error-tag>bad-element</error-tag>
    <error-severity>error</error-severity>
    <error-message>
      Element is not valid in the specified context.
    </error-message>
    <error-info>
      <bad-element>configure</bad-element>
    </error-info>
  </rpc-error>
</rpc-reply>
]]>]]>

```

5.2.3.1.3 Namespace specified in <state> tag

The following example shows a <state> tag that contains a namespace.

```

<?xml version="1.0" encoding="UTF-8"?>
<rpc message-id="101" xmlns="urn:ietf:params:xml:ns:netconf:base:1.0">
  <get>
    <filter>
      <state xmlns="urn:nokia.com:sros:ns:yang:sr:state">
      </state>
    </filter>
  </get>
</rpc>
]]>]]>

```

The following example shows the reply, which returns no errors.

```

<?xml version="1.0" encoding="UTF-8"?>
<rpc-reply message-id="101" xmlns="urn:ietf:params:xml:ns:netconf:base:1.0">
  <data>
    <state xmlns="urn:nokia.com:sros:ns:yang:sr:state">
    ...
    ...
    </state>
  </data>
</rpc-reply>
]]>]]>

```

5.2.3.1.4 Namespace error in <state> tag

The following example shows a <state> tag that does not contain a namespace.

```

<?xml version="1.0" encoding="UTF-8"?>
<rpc message-id="101" xmlns="urn:ietf:params:xml:ns:netconf:base:1.0">
  <get>
    <filter>
      <state>
      </state>
    </filter>
  </get>
</rpc>
]]>]]>

```

The following example shows the reply, which returns errors.

```
<?xml version="1.0" encoding="UTF-8"?>
<rpc-reply message-id="101" xmlns="urn:ietf:params:xml:ns:netconf:base:1.0">
  <rpc-error>
    <error-type>protocol</error-type>
    <error-tag>bad-element</error-tag>
    <error-severity>error</error-severity>
    <error-message>
      Element is not valid in the specified context.
    </error-message>
    <error-info>
      <bad-element>state</bad-element>
    </error-info>
  </rpc-error>
</rpc-reply>
]]>]]>
```

5.2.3.1.5 Output format tag

The following example shows the <get> operation combined with a subtree filter and requests the output in the MD-CLI format.

Example: MD-CLI format

```
<rpc message-id="101" xmlns="urn:ietf:params:xml:ns:netconf:base:1.0" xmlns:yang=
"urn:ietf:params:xml:ns:yang:1">
  <get>
    <format xmlns="urn:nokia.com:sros:ns:yang:sr:ietf-netconf-augments">md-cli</format>
    <filter>
      <configure xmlns="urn:nokia.com:sros:ns:yang:sr:conf">
        <system>
          <management-interface>
            <netconf/>
          </management-interface>
        </system>
      </configure>
    </filter>
  </get>
</rpc>
]]>]]>
```

The following example shows the reply.

Example: MD-CLI format reply

```
<?xml version="1.0" encoding="UTF-8"?>
<rpc-reply message-id="101" xmlns="urn:ietf:params:xml:ns:netconf:base:1.0" xmlns:yang=
"urn:ietf:params:xml:ns:yang:1">
  <data>
    configure {
      system {
        management-interface {
          netconf {
            admin-state enable
            auto-config-save true
            capabilities {
              candidate true
            }
          }
        }
      }
    }
  </data>
</rpc-reply>
]]>]]>
```

```

    }
  }
</data>
</rpc-reply>
]]>]]>

```

The following example shows the <get> operation combined with a subtree filter and requests the output in the JSON IETF format.

Example: JSON IETF format

```

<rpc message-id="101" xmlns="urn:ietf:params:xml:ns:netconf:base:1.0" xmlns:yang=
"urn:ietf:params:xml:ns:yang:1">
  <get>
    <format xmlns="urn:nokia.com:sros:ns:yang:sr:ietf-netconf-augments">json</format>
    <filter>
      <configure xmlns="urn:nokia.com:sros:ns:yang:sr:conf">
        <system>
          <management-interface>
            <netconf/>
          </management-interface>
        </system>
      </configure>
    </filter>
  </get>
</rpc>
]]>]]>

```

The following example shows the reply.

Example: JSON IETF format reply

```

<?xml version="1.0" encoding="UTF-8"?>
<rpc-reply message-id="101" xmlns="urn:ietf:params:xml:ns:netconf:base:1.0" xmlns:yang=
"urn:ietf:params:xml:ns:yang:1">
  <data>
    {
      "nokia-conf:configure": {
        "system": {
          "management-interface": {
            "netconf": {
              "admin-state": "enable",
              "auto-config-save": true,
              "capabilities": {
                "candidate": true
              }
            }
          }
        }
      }
    }
  </data>
</rpc-reply>
]]>]]>

```

5.2.3.2 <get-config>

A <get-config> operation is supported on the <running> and <candidate> datastores.

The <get-config> requests on the <candidate> datastore return only XML-formatted content. If no filter is specified for the <candidate> datastore, SR OS returns only the Nokia SR OS configurations.

For the Nokia SR OS YANG modules, <get-config> requests that specify a nonexistent list node or presence container result in an <rpc-error> response.

For the "report-all" value with the <with-defaults> tag (RFC 6243) in an XML- content layer, <get-config> returns the equivalent of the CLI command **info detail** (the returned data includes attributes that are set to their default values).

Subtree filtering is supported for <get-config> (and <get> requests). The following is the subtree filtering behavior.

- Containment nodes are supported (section 6.2.3 of RFC 6241). Nodes that contain children nodes (containers) can be used for subtree filtering. See [Containment node](#) for more information.
- Attribute match expressions (section 6.2.2 of RFC 6241) are not supported.
- Selection nodes are supported (section 6.2.4 of RFC 6241). Empty leaf nodes and list name nodes can be used as selection nodes. A selection node that is a list and does not have a key specified is supported. See [Non-key leaf specified as selection node](#) for more information.
- Content match nodes are supported (section 6.2.5 of RFC 6241). Content match nodes that are leafs but not keys are also supported. See [Non-key leaf specified as a content match node](#) for more information.

The <get-config> operation returns data nodes set by a client to their default Nokia SR OS model values (the "explicit" mode as described in RFC 6243).

To retrieve the BOF configuration, the "bof" <configuration-region> must be specified within the <get-config> <source>. For example:

```
<?xml version="1.0" encoding="UTF-8"?>
<rpc message-id="101" xmlns="urn:ietf:params:xml:ns:netconf:base:1.0">
<get-config>
  <source>
    <configuration-region xmlns="urn:nokia.com:sros:ns:yang:sr:ietf-netconf-augments">
      bof
    </configuration-region>
  </source>
  <filter>
    <bof xmlns="urn:nokia.com:sros:ns:yang:sr:bof-conf"/>
  </filter>
</get-config>
</rpc>
]]>]]>
```

To retrieve the debug configuration, the "debug" <configuration-region> must be specified within the <get-config> <source>. For example:

```
<?xml version="1.0" encoding="UTF-8"?>
<rpc message-id="101" xmlns="urn:ietf:params:xml:ns:netconf:base:1.0">
<get-config>
  <source>
    <configuration-region xmlns="urn:nokia.com:sros:ns:yang:sr:ietf-netconf-augments">
      debug
    </configuration-region>
  </source>
  <filter>
    <debug xmlns="urn:nokia.com:sros:ns:yang:sr:debug-conf"/>
  </filter>
</get-config>
</rpc>
]]>]]>
```



```

</filter>
</get-config>
</rpc>
]]>]]>

```

To retrieve the LI configuration, the "li" <configuration-region> must be specified within the <get-config> <source>. For example:

```

<get-config>
  <source>
    <configuration-region xmlns="urn:nokia.com:sros:ns:yang:sr:ietf-netconf-augments">
      li
    </configuration-region>
    <candidate/>
  </source>
  <filter>
    <li xmlns="urn:nokia.com:sros:ns:yang:sr:li-conf">
      <log>
        <log-id>
          <name>33</name>
        </log-id>
      </log>
    </li>
  </filter>
</get-config>

```

Alternatively, the <source> can be specified in the format of "configuration-region"->"datastore". For example:

```

<get-config>
  <source>
    <li-candidate xmlns="urn:nokia.com:sros:ns:yang:sr:ietf-netconf-augments"/>
  </source>
  <filter>
    <li xmlns="urn:nokia.com:sros:ns:yang:sr:li-conf">
      <log>
        <log-id>
          <name>33</name>
        </log-id>
      </log>
    </li>
  </filter>
</get-config>

```

When both the <configuration-region> and the "configuration-region"->"datastore" format are used, SR OS applies the last tag used in the XML request. For example:

```

<get-config>
  <source>
    <configuration-region xmlns="urn:nokia.com:sros:ns:yang:sr:ietf-netconf-augments">
      configure
    </configuration-region>
    <li-candidate xmlns="urn:nokia.com:sros:ns:yang:sr:ietf-netconf-augments"/>
  </source>
  <filter>
    ...
  </filter>
</get-config>

```

In the preceding example, the `<get-config>` is used to retrieve the "li" configuration data from the "li" candidate datastore.

When a mismatched namespace or `<configuration-region>` combination is specified, SR OS returns an empty `<data>`.

See [Table 26: Protocol operations and level of support in Nokia SR OS NETCONF servers](#) for more details.

If present, configuration annotations are encoded with the `nokia-attr:comment` attribute. In the following example, **configure system name** is annotated with the comment "This is a comment on the system name." in the RPC reply:

```
<?xml version="1.0" encoding="UTF-8"?>
<rpc-reply message-id="101" xmlns="urn:ietf:params:xml:ns:netconf:base:1.0">
  <data>
    <configure xmlns="urn:nokia.com:sros:ns:yang:sr:conf" xmlns:nokia-attr="urn:nokia.com:sros:ns:yang:sr:attributes">
      <system>
        <name nokia-attr:comment="This is a comment on the system name."> node2</name>
      </system>
    </configure>
  </data>
</rpc-reply>
```

The optional proprietary `<format>` argument is supported. See [Output format selection](#) for more information.

The following sections contain examples of `<get-config>` request and response messages.

- [Reply with defaults](#)
- [Reply without default values](#)
- [Containment node](#)
- [List without a key specified](#)
- [Non-key leaf specified as selection node](#)
- [Non-key leaf specified as a content match node](#)
- [Content match node on a list key](#)
- [Content match node on a leaf-list](#)
- [Output format tag](#)

5.2.3.2.1 Reply with defaults

The following example shows the use of `<with-defaults>` with a value of "report-all".

```
<?xml version="1.0" encoding="UTF-8"?>
<rpc message-id="101" xmlns="urn:ietf:params:xml:ns:netconf:base:1.0">
  <get-config>
    <source>
      <candidate/>
    </source>
    <filter>
      <configure xmlns="urn:nokia.com:sros:ns:yang:sr:conf">
        <system>
          <security>
```

```

        <cpm-filter>
          <ipv6-filter>
          </ipv6-filter>
        </cpm-filter>
      </security>
    </system>
  </configure>
</filter>
<with-defaults xmlns="urn:ietf:params:xml:ns:yang:ietf-netconf-with-defaults">
  report-all
</with-defaults>
</get-config>
</rpc>
]]>]]>

```

The following example shows the reply, which returns all attributes, even those with default values.

```

<?xml version="1.0" encoding="UTF-8"?>
<rpc-reply message-id="101" xmlns="urn:ietf:params:xml:ns:netconf:base:1.0">
  <data>
    <configure xmlns="urn:nokia.com:sros:ns:yang:sr:conf" xmlns:nokia-attr="urn:nokia.com:sros:ns:yang:sr:attributes">
      <system>
        <security>
          <cpm-filter>
            <ipv6-filter>
              <admin-state>disable</admin-state>
            </ipv6-filter>
          </cpm-filter>
        </security>
      </system>
    </configure>
  </data>
</rpc-reply>
]]>]]>

```

5.2.3.2.2 Reply without default values

The following example shows a <get-config> request using <with-defaults>.

```

<?xml version="1.0" encoding="UTF-8"?>
<rpc message-id="101" xmlns="urn:ietf:params:xml:ns:netconf:base:1.0">
  <get-config>
    <source>
      <candidate/>
    </source>
    <filter>
      <configure xmlns="urn:nokia.com:sros:ns:yang:sr:conf">
        <system>
          <security>
            <cpm-filter>
              <ipv6-filter>
              </ipv6-filter>
            </cpm-filter>
          </security>
        </system>
      </configure>
    </filter>
  </get-config>
</rpc>

```

```
]]>]]>
```

The following output shows the reply, which does not return attributes with default values.

```
<?xml version="1.0" encoding="UTF-8"?>
<rpc message-id="101" xmlns="urn:ietf:params:xml:ns:netconf:base:1.0">
<get-config>
  <source>
    <candidate/>
  </source>
  <filter>
    <configure xmlns="urn:nokia.com:sros:ns:yang:sr:conf">
      <system>
        <security>
          <cpm-filter>
            <ipv6-filter>
            </ipv6-filter>
          </cpm-filter>
        </security>
      </system>
    </configure>
  </filter>
</get-config>
</rpc>
]]>]]>
```

5.2.3.2.3 Containment node

The following example shows a containment node.

```
<?xml version="1.0" encoding="UTF-8"?>
<rpc message-id="101" xmlns="urn:ietf:params:xml:ns:netconf:base:1.0">
<get-config>
  <source><running/></source>
  <filter>
    <configure xmlns="urn:nokia.com:sros:ns:yang:sr:conf">
      <router/>
    </configure>
  </filter>
</get-config>
</rpc>
]]>]]>
```

5.2.3.2.4 List without a key specified

The following example shows a selection node that is a list and does not have a key specified.

```
<?xml version="1.0" encoding="UTF-8"?>
<rpc message-id="101" xmlns="urn:ietf:params:xml:ns:netconf:base:1.0">
  <get-config>
    <source><running/></source>
    <filter>
      <configure xmlns="urn:nokia.com:sros:ns:yang:sr:conf">
        <router>
          <interface>
          </interface>
        </router>
      </configure>
    </filter>
  </get-config>
</rpc>
]]>]]>
```

```

        </configure>
      </filter>
    </get-config>
  </rpc>
}>]]>

```

5.2.3.2.5 Non-key leaf specified as selection node

The following example shows a list with a non-key leaf specified as a selection node. Keys are returned as well.

```

<?xml version="1.0" encoding="UTF-8"?>
<rpc message-id="101" xmlns="urn:ietf:params:xml:ns:netconf:base:1.0">
  <get-config>
    <source><running/></source>
    <filter>
      <configure xmlns="urn:nokia.com:sros:ns:yang:sr:conf">
        <router>
          <interface>
            <admin-state/>
          </interface>
        </router>
      </configure>
    </filter>
  </get-config>
</rpc>
}>]]>

```

5.2.3.2.6 Non-key leaf specified as a content match node

The following example shows a non-key leaf specified as a content match node.

```

<?xml version="1.0" encoding="UTF-8"?>
<rpc message-id="101" xmlns="urn:ietf:params:xml:ns:netconf:base:1.0">
  <get-config>
    <source><running/></source>
    <filter>
      <configure xmlns="urn:nokia.com:sros:ns:yang:sr:conf">
        <router>
          <interface>
            <admin-state>disable</admin-state>
          </interface>
        </router>
      </configure>
    </filter>
  </get-config>
</rpc>
}>]]>

```

5.2.3.2.7 Content match node on a list key

Multiple key leaves for the same key cannot be requested inside the same instance of the list name node. Instead, each key value must be inside its own instance of the list name node; for example,

```
<interface><interface-name>abc</interface-name></interface><interface>
<interface-name>def</interface-name></interface>.
```

The following example shows a content match node on a list key.

```
<?xml version="1.0" encoding="UTF-8"?>
<rpc message-id="101" xmlns="urn:ietf:params:xml:ns:netconf:base:1.0">
  <get-config>
    <source><running/></source>
    <filter>
      <configure xmlns="urn:nokia.com:sros:ns:yang:sr:conf">
        <router>
          <interface>
            <interface-name>Test</interface-name>
          </interface>
        </router>
      </configure>
    </filter>
  </get-config>
</rpc>
]]>]]>
```

5.2.3.2.8 Content match node on a leaf-list

A content match node can be performed on a leaf-list but SR OS requires that all of the leaf-list elements and nodes must be specified. The full configuration (equivalent to the classic CLI command **admin display-config** or the MD-CLI command **admin show configuration**) can be obtained using a <get-config> request both when a <filter> tag is not present and when the <configure> tag is present inside a <filter> tag.

The following example shows a content match node on a leaf-list when the <filter> tag is not present.

```
<?xml version="1.0" encoding="UTF-8"?>
<rpc message-id="101" xmlns="urn:ietf:params:xml:ns:netconf:base:1.0">
  <get-config>
    <source><running/></source>
  </get-config>
</rpc>
]]>]]>

<?xml version="1.0" encoding="UTF-8"?>
<rpc message-id="101" xmlns="urn:ietf:params:xml:ns:netconf:base:1.0">
  <get-config>
    <source><candidate/></source>
  </get-config>
</rpc>
]]>]]>
```

The following example shows a content match node on a leaf-list when only the <configure> tag is present inside the <filter> tag.

```
<?xml version="1.0" encoding="UTF-8"?>
<rpc message-id="101" xmlns="urn:ietf:params:xml:ns:netconf:base:1.0">
  <get-config>
    <source><running/></source>
    <filter>
      <configure xmlns="urn:nokia.com:sros:ns:yang:sr:conf"/>
    </filter>
  </get-config>
```

```

</rpc>
]]>]]>

<?xml version="1.0" encoding="UTF-8"?>
<rpc message-id="101" xmlns="urn:ietf:params:xml:ns:netconf:base:1.0">
  <get-config>
    <source><candidate/></source>
    <filter>
      <configure xmlns="urn:nokia.com:sros:ns:yang:sr:conf"/>
    </filter>
  </get-config>
</rpc>
]]>]]>

```

5.2.3.2.9 Output format tag

The following example shows the <get-config> operation combined with a subtree filter and requests the output in the MD-CLI format.

Example: MD-CLI format

```

<rpc message-id="101" xmlns="urn:ietf:params:xml:ns:netconf:base:1.0" xmlns:yang=
"urn:ietf:params:xml:ns:yang:1">
  <get-config>
    <format xmlns="urn:nokia.com:sros:ns:yang:sr:ietf-netconf-augments">md-cli</format>
    <source><running/></source>
    <filter>
      <configure xmlns="urn:nokia.com:sros:ns:yang:sr:conf">
        <system>
          <management-interface>
            <netconf/>
          </management-interface>
        </system>
      </configure>
    </filter>
  </get-config>
</rpc>
]]>]]>

```

The following example shows the reply.

Example: MD-CLI format reply

```

<?xml version="1.0" encoding="UTF-8"?>
<rpc-reply message-id="101" xmlns="urn:ietf:params:xml:ns:netconf:base:1.0" xmlns:yang=
"urn:ietf:params:xml:ns:yang:1">
  <data>
    configure {
      system {
        management-interface {
          netconf {
            admin-state enable
            auto-config-save true
            capabilities {
              candidate true
            }
          }
        }
      }
    }
  }
}

```

```

    </data>
  </rpc-reply>
}>]]>

```

The following example shows the `<get-config>` operation combined with a subtree filter and requests the output in the JSON IETF format.

Example: JSON IETF format

```

<rpc message-id="101" xmlns="urn:ietf:params:xml:ns:netconf:base:1.0" xmlns:yang=
"urn:ietf:params:xml:ns:yang:1">
  <get-config>
    <format xmlns="urn:nokia.com:sros:ns:yang:sr:ietf-netconf-augments">json</format>
    <source><running/></source>
    <filter>
      <configure xmlns="urn:nokia.com:sros:ns:yang:sr:conf">
        <system>
          <management-interface>
            <netconf/>
          </management-interface>
        </system>
      </configure>
    </filter>
  </get-config>
</rpc>
]]>]]>

```

The following example shows the reply.

Example: JSON IETF format reply

```

<?xml version="1.0" encoding="UTF-8"?>
<rpc-reply message-id="101" xmlns="urn:ietf:params:xml:ns:netconf:base:1.0" xmlns:yang=
"urn:ietf:params:xml:ns:yang:1">
  <data>
    {
      "nokia-conf:configure": {
        "system": {
          "management-interface": {
            "netconf": {
              "admin-state": "enable",
              "auto-config-save": true,
              "capabilities": {
                "candidate": true
              }
            }
          }
        }
      }
    }
  </data>
</rpc-reply>

```

5.2.3.3 <edit-config>

An `<edit-config>` operation is supported on the `<candidate>` datastore. The `<edit-config>` requests that specify the `<running>` datastore as a target when using the `"urn:nokia.com:sros:ns:yang:sr:conf"` namespace (the Nokia SR OS YANG modules) result in an error response.

The <edit-config> requests to the <candidate> datastore only result in XML- formatted content.

An internal "implicit" lock is placed on the <running> datastore; the datastore has a scope of all configuration commands in SR OS (not just the "urn:nokia.com:sros:ns:yang:sr:conf" namespace). The following actions affect the "implicit" lock.

- The first NETCONF <edit-config> on a global <candidate> datastore triggers the "implicit" lock.
- The completion of a NETCONF <commit> releases the "implicit" lock.
- The NETCONF <discard-changes> operation releases the "implicit" lock.

The following scenarios are impacted when the "implicit" lock is in place.

- All classic CLI commands are blocked while in model-driven configuration mode, and SR OS returns an error.
- An SNMP set request is blocked while in model-driven configuration mode, and SR OS returns an error.

One or more <edit-config> requests can be performed on the <candidate> datastore before the changes are committed or discarded.

The supported <edit-config> operation attribute values are listed in [Table 27: <edit-config> operation attribute values](#).

Table 27: <edit-config> operation attribute values

| Command | Notes |
|--|--|
| urn:nokia.com:sros:ns:yang:sr:conf namespace Nokia SR OS YANG modules | |
| merge (Nokia SR OS modules) | Supported |
| remove (Nokia SR OS modules) | <p>A remove operation removes the deleted configuration and returns it to the default value.</p> <p>A remove operation automatically removes all child objects of a deleted object (leaves, lists, containers, and so on).</p> <p>Explicit shutdown of the object being removed (or any child) is not required and results in an error if a merge operation is specified on a tag that inherits a remove operation.</p> <p>A remove operation is allowed on non-presence containers. The non-presence container and all of its children are removed (for example, a non-presence container with no child nodes is not displayed in a <get> or <get-config> reply).</p> <p>A remove operation is allowed on an object where all child branches and dependencies are automatically removed (but the remove operation fails if any outside objects is linked to the object being removed).</p> <p>A remove operation is allowed on a <shutdown/> leaf (which returns it to its default value).</p> <p>A remove operation is allowed on a non-Boolean leaf.</p> <p>On specifying a remove operation on a node where none of its children belong to the urn:nokia.com:sros:ns:yang:sr:conf namespace (the Nokia</p> |

| Command | Notes |
|---|---|
| | <p>SR OS YANG modules), SR OS does not return an error and completes the node removal.</p> <p>A remove operation for a leaf, where the request also specifies a value for the leaf, results in an error.</p> |
| <p>delete (Nokia SR OS modules)</p> | <p>SR OS returns an error if a delete operation is performed on a list that does not specify a key (that is, an attempt to delete all members of a list).</p> <p>SR OS returns an error if a delete operation is performed on a leaf or presence container that is already deleted (or has the default value and the default-handling is trim).</p> <p>SR OS may return an error and may not complete the deletion operation when a delete operation is performed on a node where any of its children do not belong to the urn:nokia.com:sros:ns:yang:sr:conf namespace (the Nokia SR OS YANG modules).</p> <p>A delete operation removes the deleted configuration and returns it to the default value.</p> <p>A delete operation automatically deletes all child objects of a deleted object (leaves, lists, containers, and so on).</p> <p>Explicit shutdown of the object being deleted (or any of its children) is not required and results in an error if a merge operation is specified on a tag that inherits a delete operation.</p> <p>A delete operation is allowed on non-presence containers. The non-presence container and all of its children are deleted (for example, a non-presence container with no child nodes is not displayed in a <get> or <get-config> reply).</p> <p>A delete operation is allowed on an object where all child branches and dependencies are automatically deleted (but the delete operation fails if any outside objects is linked to the object being deleted).</p> <p>A delete operation is allowed on a <shutdown/> leaf (which returns it to its default value).</p> <p>A delete operation is allowed on a non-Boolean leaf.</p> <p>On specifying a delete operation on a node where none of its children belong to the urn:nokia.com:sros:ns:yang:sr:conf namespace (the Nokia SR OS YANG modules), SR OS does not return an error and completes the node deletion.</p> <p>A delete operation for a leaf, where the request also specifies a value for the leaf, results in an error.</p> |
| <p>create (Nokia SR OS modules)</p> | <p>When a create operation for a leaf or presence container is performed, SR OS returns an error if the leaf or presence container is being set to the same value (unless the default-handling is trim and the value being set is the default value).</p> |
| <p>replace</p> | <p>Supported</p> |

| Command | Notes |
|-----------------------|-------|
| (Nokia SR OS modules) | |

The <edit-config> operation <default-operation> parameter is supported with the following values:

- replace
- merge
- none

In the urn:nokia.com:sros:ns:yang:sr:conf namespace (the Nokia SR OS YANG modules), an operation of "none" (inherited or direct) on a leaf node that does not exist in the data model causes SR OS to return an error with an <error-tag> value of data-missing.

For delete and remove operations in the Nokia SR OS namespace, the SR OS NETCONF server will recursively unwind any children of the node being deleted or removed first before removing the node. The deepest child branch of the request is examined first, and any leaves are processed, after which the server works backwards out of the deepest branches back up to the object where the delete operation was specified.

The following applies to the urn:nokia.com:sros:ns:yang:sr:conf namespace (the Nokia SR OS YANG modules):

- SR OS returns an error if an explicitly defined <edit-config> operation (such as "delete") is specified on a "key" leaf.
- The "operation" attribute is inherited from the parent node if not explicitly specified (similar to namespaces). If no parent node is available, the "default-operation" value is used. This means that the "operation" attribute has a "scope" that it applies to the nested nodes until it is redefined.

See [Application of default operation value for parent and child nodes](#) and [Exceptions to the default operation handling](#) for more information.

The following scenarios simplify "operation" inheritance, where the first line in each scenario represents the operation value of the parent node and the following lines represent the possible operation values for the child nodes and the SR OS behavior in each case:

- **Create**

Create/Merge: SR OS processes the request, which succeeds or fails based on the behavior of this operation.

Delete/Remove: SR OS returns an error.

- **Merge**

Create/Merge/Delete/Remove: SR OS processes the request, which succeeds or fails based on the behavior of this operation.

- **Delete/Remove**

Create/Merge: SR OS returns an error.

Delete/Remove: SR OS processes the request, which succeeds or fails based on the behavior of this operation.

The <error-option> is supported. SR OS implements the rollback-on-error behavior at all times, when:

- the error-option is not specified
- the error-option is specified and set to either stop-on-error or rollback-on-error

As per RFC 6020, *YANG - A Data Modeling Language for the Network Configuration Protocol (NETCONF)*, the "insert" and "value" attributes are supported with user-ordered leaf-lists to insert or move a user-ordered leaf-list entry in the candidate datastore.

As per RFC 6020, the "insert" and "key" attributes are supported with user-ordered lists to insert or move a user-ordered list entry in the candidate datastore.

With a NETCONF <edit-config> RPC, SR OS authorizes all configuration changes in the <candidate> datastore; that is, it checks the YANG tree and authorizes every changed managed object (MO).

The deletion of a container results in the deletion of any children containers that are authorized for deletion, as well as their contents. Children containers that are not authorized for deletion, as well as their contents, are retained. For example, upon deletion of **configure system**, **configure system security** is not deleted because the deletion of that child container is not authorized.



Note: A "no change" for a value does not require authorization. Therefore, it is possible to execute a non-authorized command if there is no change in value.

For example, when a user is not authorized to change **access li**, but attempts to change it for another a user who already has **access li**, SR OS allows that action because there is no change in value.

To edit the BOF configuration, the "bof" <configuration-region> must be specified within the <edit-config> <target>. For example:

```
<?xml version="1.0" encoding="UTF-8"?>
<rpc message-id="101" xmlns="urn:ietf:params:xml:ns:netconf:base:1.0">
<edit-config>
  <target>
    <configuration-region xmlns="urn:nokia.com:sros:ns:yang:sr:ietf-netconf-augments">bof</
configuration-region>
    <candidate/>
  </target>
  <config>
    <bof xmlns="urn:nokia.com:sros:ns:yang:sr:bof-conf">
      <console>
        <wait-time>5</wait-time>
      </console>
    </bof>
  </config>
</edit-config>
</rpc>
]]>]]>
```

To edit the debug configuration, the "debug" <configuration-region> must be specified within the <edit-config><target>. For example:

```
<?xml version="1.0" encoding="UTF-8"?>
<rpc message-id="101" xmlns="urn:ietf:params:xml:ns:netconf:base:1.0">
<edit-config>
  <target>
    <configuration-region xmlns="urn:nokia.com:sros:ns:yang:sr:ietf-netconf-augments">
      debug
    </configuration-region>
    <candidate/>
  </target>
  <config>
    <!-- place debug configuration changes here -->
  </config>
</edit-config>
</rpc>
```

```
]]>]]>
```

To edit the LI configuration, the "li" <configuration-region> must be specified within the <edit-config> <target>. For example:

```
<edit-config>
  <target>
    <configuration-region xmlns="urn:nokia.com:sros:ns:yang:sr:ietf-netconf-augments">
      li
    </configuration-region>
    <candidate/>
  </target>
</edit-config>
<config>
  <!-- place LI configuration changes here -->
</config>
```

Alternatively, the <target> can be specified in the format of "configuration-region"->"datastore". For example:

```
<edit-config>
  <target>
    <li-candidate xmlns="urn:nokia.com:sros:ns:yang:sr:ietf-netconf-augments"/>
  </target>
</edit-config>
<config>
  <!-- place LI configuration changes here -->
</config>
```

When both the <configuration-region> and the "configuration-region"->"datastore" format are used, SR OS applies the last tag used in the XML request. For example:

```
<edit-config>
  <target>
    <configuration-region xmlns="urn:nokia.com:sros:ns:yang:sr:ietf-netconf-augments">
      configure
    </configuration-region>
    <li-candidate xmlns="urn:nokia.com:sros:ns:yang:sr:ietf-netconf-augments"/>
  </target>
</edit-config>
<config>
  <!-- place LI configuration changes here -->
</config>
```

When a mismatched namespace or <configuration-region> combination is specified, SR OS returns an error.

The <edit-config> RPC can only be used to push LI configuration changes if all of the following conditions are true.

- The NETCONF user is an LI user.
- The NETCONF session has an exclusive lock on the LI configuration region and <candidate> datastore.
- The specified <configuration-region> is "li".
- The YANG modules that are used are the Nokia SR OS YANG modules.

If any of the preceding conditions is false, SR OS returns an error.

See [Table 26: Protocol operations and level of support in Nokia SR OS NETCONF servers](#) for more details.

Configuration annotations may be encoded with the `nokia-attr:comment` attribute to add, change, or delete the annotations. In the following example, **configure system name** is annotated with the comment "This is a comment on the system name." in the `<edit-config>` RPC:

```
<rpc message-id="101" xmlns="urn:ietf:params:xml:ns:netconf:base:1.0">
  <edit-config>
    <target><candidate/></target>
    <config>
      <configure xmlns="urn:nokia.com:sros:ns:yang:sr:conf" xmlns:nokia-attr="urn:nokia.com:sros:ns:yang:sr:attributes">
        <system>
          <name nokia-attr:comment="This is a comment on the system name.">node2</name>
        </system>
      </configure>
    </config>
  </edit-config>
</rpc>
]]>]]>
```

See the following sections for examples of `<edit-config>` request and response messages:

- [<running> datastore with the "urn:nokia.com:sros:ns:yang:sr:conf" namespace](#)
- [Application of default operation value for parent and child nodes](#)
- [Exceptions to the default operation handling](#)

5.2.3.3.1 <running> datastore with the "urn:nokia.com:sros:ns:yang:sr:conf" namespace

The following example shows the use of the `<running>` datastore with the "urn:nokia.com/sros:ns:yang:sr:conf" namespace.

```
<?xml version="1.0" encoding="UTF-8"?>
<rpc message-id="101" xmlns="urn:ietf:params:xml:ns:netconf:base:1.0">
  <edit-config>
    <target><running/></target>
    <config>
      <configure xmlns="urn:nokia.com:sros:ns:yang:sr:conf">
        <python>
          <python-script>
            <script-name>testing</script-name>
          </python-script>
        </python>
      </configure>
    </config>
  </edit-config>
</rpc>
]]>]]>
```

The following example shows the reply, which returns SR OS errors.

```
<?xml version="1.0" encoding="UTF-8"?>
<rpc-reply message-id="101" xmlns="urn:ietf:params:xml:ns:netconf:base:1.0">
  <rpc-error>
    <error-type>protocol</error-type>
    <error-tag>operation-not-supported</error-tag>
    <error-severity>error</error-severity>
    <error-message>
      writable-running capability is not supported
    </error-message>
  </rpc-error>
</rpc-reply>
```

```

    <error-info>
      <bad-element>running</bad-element>
    </error-info>
  </rpc-error>
</rpc-reply>
]]>]]>

```

5.2.3.3.2 Application of default operation value for parent and child nodes

The following example shows that the default (operation="merge") applies to all parent and child nodes.

```

<?xml version="1.0" encoding="UTF-8"?>
<rpc message-id="101" xmlns="urn:ietf:params:xml:ns:netconf:base:1.0">
  <edit-config>
    <target><candidate/></target>
    <config>
      <configure xmlns="urn:nokia.com:sros:ns:yang:sr:conf">
        <service>
          <epipe>
            <service-name>CustDoc</service-name>
            <customer>1</customer>
            <description>Local epipe</description>
          </epipe>
        </service>
      </configure>
    </config>
  </edit-config>
</rpc>
]]>]]>

```

The following example shows the reply.

```

<?xml version="1.0" encoding="UTF-8"?>
<rpc-reply message-id="101" xmlns="urn:ietf:params:xml:ns:netconf:base:1.0">
  <ok/>
</rpc-reply>
]]>]]>

```

5.2.3.3.3 Exceptions to the default operation handling

The following example shows that the default (operation="merge") applies to all parent and child nodes except for <description>, which has a (operation="remove").

```

<?xml version="1.0" encoding="UTF-8"?>
<rpc message-id="101" xmlns="urn:ietf:params:xml:ns:netconf:base:1.0"
  xmlns:nc="urn:ietf:params:xml:ns:netconf:base:1.0">
  <edit-config>
    <target><candidate/></target>
    <config>
      <configure xmlns="urn:nokia.com:sros:ns:yang:sr:conf">
        <service>
          <epipe>
            <service-name>CustDoc</service-name>
            <customer>1</customer>
            <description nc:operation="remove">Local epipe</description>
          </epipe>
        </service>
      </configure>
    </config>
  </edit-config>
</rpc>
]]>]]>

```

```

        </service>
      </configure>
    </config>
  </edit-config>
</rpc>
]]>]]>

```

The following example shows the reply.

```

<?xml version="1.0" encoding="UTF-8"?>
<rpc-reply message-id="101" xmlns="urn:ietf:params:xml:ns:netconf:base:1.0" xmlns:nc=
"urn:ietf:params:xml:ns:netconf:base:1.0">
  <ok/>
</rpc-reply>
]]>]]>

```

5.2.3.4 <copy-config>

To <copy-config> the BOF configuration, the "bof" <configuration-region> must be specified within the <copy-config> RPC <source> and <target>. For example:

```

<?xml version="1.0" encoding="UTF-8"?>
<rpc message-id="101" xmlns:nc="urn:ietf:params:xml:ns:netconf:base:1.0">
<copy-config>
  <target>
    <configuration-region xmlns="urn:nokia.com:sros:ns:yang:sr:ietf-netconf-augments">bof</
configuration-region>
    <startup/>
  </target>
  <source>
    <configuration-region xmlns="urn:nokia.com:sros:ns:yang:sr:ietf-netconf-augments">bof</
configuration-region>
    <running/>
  </source>
</copy-config>
</rpc>
]]>]]>

```



Note:

When <copy-config> RPC is used with the "bof" <configuration-region>, only the following combinations are supported:

- <source><config></config></source> and <target><candidate/></target>
- <source><running/></source> and <target><startup/></target>

To <copy-config> debug configuration, the "debug" <configuration-region> must be specified within the <copy-config> RPC <source> **and** <target>. For example:

```

<?xml version="1.0" encoding="UTF-8"?>
<rpc message-id="101" xmlns:nc="urn:ietf:params:xml:ns:netconf:base:1.0">
<copy-config>
  <target>
    <configuration-region xmlns="urn:nokia.com:sros:ns:yang:sr:ietf-netconf-
augments">debug</configuration-region>
    <candidate/>
  </target>
  <source>

```



```

        <configuration-region xmlns="urn:nokia.com:sros:ns:yang:sr:ietf-netconf-
augments">debug</configuration-region>
        <config></config>
    </source>
</copy-config>
</rpc>
]]>]]>

```

**Note:**

When `<copy-config>` RPC is used with the "debug" `<configuration-region>`, only the following combination is supported:

- `<source><config></config></source>` and `<target><candidate/></target>`

To `<copy-config>` LI configuration, the "li" `<configuration-region>` must be specified within the `<copy-config>` RPC `<source>` **and** `<target>`. When the `<configuration-region>` is "li" or "bof", SR OS can only `<copy-config>` from the `<running>` datastore to the `<startup>` datastore. For example:

```

<copy-config>
  <target>
    <configuration-region xmlns="urn:nokia.com:sros:ns:yang:sr:ietf-netconf-augments">
      li
    </configuration-region>
    <startup/>
  </target>
  <source>
    <configuration-region xmlns="urn:nokia.com:sros:ns:yang:sr:ietf-netconf-augments">li</
configuration-region>
    <running/>
  </source>
</copy-config>

```

Performing a `<copy-config>` between datastores from different configuration regions is not allowed. Mismatching the source or target `<configuration-region>` causes SR OS to return an error.

Alternatively, the `<target>/<source>` can be specified in the format of "configuration-region"-`"datastore"`. For example:

```

<copy-config>
  <target>
    <li-startup xmlns="urn:nokia.com:sros:ns:yang:sr:ietf-netconf-augments"/>
  </target>
  <source>
    <li-running xmlns="urn:nokia.com:sros:ns:yang:sr:ietf-netconf-augments"/>
  </source>
</copy-config>

```

When both the `<configuration-region>` and the "configuration-region"-`"datastore"` format are used, SR OS applies the last tag used in the XML request. For example:

```

<copy-config>
  <target>
    <configuration-region xmlns="urn:nokia.com:sros:ns:yang:sr:ietf-netconf-augments">
      configure
    </configuration-region>
    <li-startup xmlns="urn:nokia.com:sros:ns:yang:sr:ietf-netconf-augments"/>
  </target>
  <source>
    <configuration-region xmlns="urn:nokia.com:sros:ns:yang:sr:ietf-netconf-augments">
      configure

```

```
</configuration-region>
<li-running xmlns="urn:nokia.com:sros:ns:yang:sr:ietf-netconf-augments"/>
</source>
</copy-config>
```

In the preceding example, the `<copy-config>` is used to copy the configuration data from the "li" `<running>` datastore to the "li" `<startup>` datastore.

See [Table 26: Protocol operations and level of support in Nokia SR OS NETCONF servers](#) for more details.

5.2.3.5 <delete-config>

See [Table 26: Protocol operations and level of support in Nokia SR OS NETCONF servers](#) for more details.

5.2.3.6 <lock>

Taking the `<candidate>` datastore lock is equivalent to starting a CLI exclusive session. A NETCONF session cannot take the `<candidate>` datastore lock if there are uncommitted configuration changes in the `<candidate>` datastore.

It is recommended that a NETCONF session should always take the `<candidate>` datastore lock before reading or writing configurations to ensure the `<candidate>` datastore is not changed by other model-driven sessions. Release the `<candidate>` datastore lock after all configurations are successfully read or committed.

When either the `<running>` datastore lock or the `<candidate>` datastore lock is taken by a NETCONF session:

- no NETCONF session can take the `<running>` datastore lock
- no NETCONF session can take the `<candidate>` datastore lock
- no other NETCONF session can do an `<edit-config>` on the `<running>` datastore
- no other NETCONF session can do an `<edit-config>` on the `<candidate>` datastore
- no other NETCONF session can do a `<commit>` on the `<candidate>` datastore
- no other NETCONF session can do a `<discard-changes>` on the `<candidate>` datastore
- CLI becomes read-only
- classic CLI **rollback revert** is blocked

A datastore lock is unlocked when disconnecting a NETCONF session (either from the CLI using the **admin disconnect** command, using Ctrl-c, or by performing a `<kill-session>` / `<close-session>` operation). Upon disconnecting a NETCONF session that had acquired a datastore lock, SR OS:

- releases the lock
- discards any "uncommitted" changes



Note: The behavior is different if the disconnected NETCONF session was using the global `<candidate>` datastore and had uncommitted configuration changes. In that case, SR OS keeps the "uncommitted" changes in the global `<candidate>` datastore.

Timeouts for locks are not supported. No specific **admin** or **tools** commands are provided to release the lock without disconnecting the session that holds it, but the session that holds the lock can be administratively disconnected through a CLI command to release the lock.

Using a CLI **show** command, the operator can determine whether the <running> datastore is locked, the <candidate> datastore is locked, or both are locked, and the session ID of the session that holds the lock.

From CLI, the operator can configure whether users that belong to a specific profile have permission to lock NETCONF sessions.

An active NETCONF session can be disconnected from the CLI using the session ID. The user can use the **show** command to find the NETCONF session ID, then use this session ID in the **admin** command to disconnect the NETCONF session.

To lock a BOF datastore, the "bof" <configuration-region> must be specified within the <lock> <target>. For example:

```
<?xml version="1.0" encoding="UTF-8"?>
<rpc message-id="101" xmlns="urn:ietf:params:xml:ns:netconf:base:1.0">
  <lock>
    <target>
      <configuration-region xmlns="urn:nokia.com:sros:ns:yang:sr:ietf-netconf-
augments">
        bof
      </configuration-region>
    </target>
  </lock>
</rpc>
]]>]]>
```

To lock a debug datastore, the "debug" <configuration-region> must be specified within the <lock> <target>. For example:

```
<?xml version="1.0" encoding="UTF-8"?>
<rpc message-id="101" xmlns="urn:ietf:params:xml:ns:netconf:base:1.0">
  <lock>
    <target>
      <configuration-region xmlns="urn:nokia.com:sros:ns:yang:sr:ietf-netconf-
augments">
        debug
      </configuration-region>
    </target>
  </lock>
</rpc>
]]>]]>
```

To lock an LI datastore, the "li" <configuration-region> must be specified within the <lock> <target>. For example:

```
<lock>
  <target>
    <configuration-region xmlns="urn:nokia.com:sros:ns:yang:sr:ietf-netconf-augments">
      li
    </configuration-region>
  </target>
</lock>
```

Alternatively, the <target> can be specified in the format of "configuration-region"->datastore". For example:

```
<lock>
  <target>
    <li-candidate xmlns="urn:nokia.com:sros:ns:yang:sr:ietf-netconf-augments" />
  </target>
</lock>
```

When both the <configuration-region> and the "configuration-region"->datastore" format are used, SR OS applies the last tag used in the XML request. For example:

```
<lock>
  <target>
    <configuration-region xmlns="urn:nokia.com:sros:ns:yang:sr:ietf-netconf-augments">
      configure
    </configuration-region>
    <li-candidate xmlns="urn:nokia.com:sros:ns:yang:sr:ietf-netconf-augments" />
  </target>
</lock>
```

In the preceding example, the <lock> is used to lock the "li" <candidate> datastore.

The LI datastores have independent locks from the main configuration datastores.

See [Table 26: Protocol operations and level of support in Nokia SR OS NETCONF servers](#) for more details.

5.2.3.7 <unlock>

Because there is a single lock per datastore, regardless of the scope of that lock, the following restrictions apply to the <unlock> operation.

- The <running> datastore lock is unlocked by using the <unlock> command only on the <running> datastore. An error results and the lock stays if a different datastore is specified with the <unlock> operation.
- The <candidate> datastore lock is unlocked by using the <unlock> command only on the <candidate> datastore. An error results and the lock stays if a different datastore is specified with the <unlock> operation.

Performing an <unlock> operation on the <candidate> datastore discards all pending (not committed) <candidate> datastore changes.

To unlock a BOF datastore, the "bof" <configuration-region> must be specified within the <unlock> <target>. For example:

```
<?xml version="1.0" encoding="UTF-8"?>
<rpc message-id="101" xmlns="urn:ietf:params:xml:ns:netconf:base:1.0">
  <unlock>
    <target>
      <configuration-region xmlns="urn:nokia.com:sros:ns:yang:sr:ietf-netconf-
augments">
        bof
      </configuration-region>
      <candidate/>
    </target>
  </unlock>
</rpc>
```

```
]]>]]>
```

To unlock a debug datastore, the "debug" <configuration-region> must be specified within the <unlock> <target>. For example:

```
<?xml version="1.0" encoding="UTF-8"?>
<rpc message-id="101" xmlns="urn:ietf:params:xml:ns:netconf:base:1.0">
  <unlock>
    <target>
      <configuration-region xmlns="urn:nokia.com:sros:ns:yang:sr:ietf-netconf-
augments">
        debug
      </configuration-region>
    <candidate/>
    </target>
  </unlock>
</rpc>
]]>]]>
```

To unlock an LI datastore, the "li" <configuration-region> must be specified within the <unlock> <target>. For example:

```
<unlock>
  <target>
    <configuration-region xmlns="urn:nokia.com:sros:ns:yang:sr:ietf-netconf-augments">
      li
    </configuration-region>
  <candidate/>
</target>
</unlock>
```

Alternatively, the <target> can be specified in the format of "configuration-region"->datastore". For example:

```
<unlock>
  <target>
    <li-candidate xmlns="urn:nokia.com:sros:ns:yang:sr:ietf-netconf-augments" />
  </target>
</unlock>
```

When both the <configuration-region> and the "configuration-region"->datastore" format are used, SR OS applies the last tag used in the XML request. For example:

```
<unlock>
  <target>
    <configuration-region xmlns="urn:nokia.com:sros:ns:yang:sr:ietf-netconf-augments">
      configure
    </configuration-region>
    <li-candidate xmlns="urn:nokia.com:sros:ns:yang:sr:ietf-netconf-augments" />
  </target>
</unlock>
```

In the preceding example, the <unlock> is used to unlock the "li" <candidate> datastore.

See [Table 26: Protocol operations and level of support in Nokia SR OS NETCONF servers](#) for more information.

5.2.3.8 <commit>

The following are the characteristics of the <commit> command.

- It represents the equivalent of the CLI command **commit**.
- When a <commit> operation fails and more than one error exists, SR OS returns multiple errors.
- When SR OS is not able to commit all the changes in the <candidate> datastore, SR OS keeps the <running> datastore unchanged.
- When a NETCONF session is disconnected (using the CLI command, Ctrl-c, or <kill-session>) in the middle of a <commit> operation, SR OS keeps the <running> datastore unchanged.
- The persistency of changes made using a <commit> operation is operator-controlled. A copy of the <running> datastore to the <startup> datastore can be automatically performed after each successful <commit> operation. This behavior can be enabled or disabled through a CLI command.
- If changes exist in the <candidate> datastore (before they are committed to the <running> datastore), this impacts:
 - a CLI user trying to make immediate changes, because SR OS may block some CLI immediate configurations
 - an SNMP set request, because SR OS may block the request and return an error

To commit the BOF configuration, the "bof" <configuration-region> must be specified within the <commit> RPC. For example:

```
<?xml version="1.0" encoding="UTF-8"?>
<rpc message-id="101" xmlns="urn:ietf:params:xml:ns:netconf:base:1.0">
<commit>
  <configuration-region xmlns="urn:nokia.com:sros:ns:yang:sr:ietf-netconf-augments">
    bof
  </configuration-region>
</commit>
</rpc>
]]>]]>
```

To commit the debug configuration, the "debug" <configuration-region> must be specified within the <commit> RPC. For example:

```
<?xml version="1.0" encoding="UTF-8"?>
<rpc message-id="101" xmlns="urn:ietf:params:xml:ns:netconf:base:1.0">
<commit>
  <configuration-region xmlns="urn:nokia.com:sros:ns:yang:sr:ietf-netconf-augments">
    debug
  </configuration-region>
</commit>
</rpc>
]]>]]>
```

To commit the LI configuration, the "li" <configuration-region> must be specified within the <commit> RPC. For example:

```
<commit>
  <configuration-region xmlns="urn:nokia.com:sros:ns:yang:sr:ietf-netconf-augments">
    li
  </configuration-region>
</commit>
```

The <commit> RPC can only be used with LI configuration changes if all of the following conditions are true.

- The NETCONF user is a LI user.
- The NETCONF session has an exclusive lock on the LI configuration region and <candidate> datastore.
- The specified <configuration-region> is "li".
- The YANG modules used are the Nokia SR OS YANG modules.

If any of the preceding conditions are false, SR OS returns an error.

The :confirmed-commit capability cannot be used with LI configuration changes.

The :confirmed-commit capability is advertised in the SR OS NETCONF server <hello> as:

```
<capability>urn:ietf:params:netconf:capability:confirmed-commit:1.1</capability>
```

The :confirmed-commit capability includes the following characteristics.

- The capability is not advertised if the operator disables the <candidate> datastore capability using the available SR OS CLI command.
- [Table 28: Parameters for a <commit> operation](#) lists the supported parameters for a <commit> operation.

Table 28: Parameters for a <commit> operation

| Parameter | Description |
|-------------------|--|
| <comment> | Optional. Specifies a comment in the commit history. |
| <confirmed> | Indicates a confirmed <commit> operation. |
| <confirm-timeout> | Specifies the timeout period for confirmed commit (in seconds). If unspecified, the confirmed commit timeout defaults to 600 seconds (10 minutes). |
| <persist> | Configures the confirmed commit changes to survive a session termination. It sets a token on the ongoing confirmed commit. If <persist> is not in the confirmed commit operation, any follow-up commit and the confirming commit must be issued on the same session that issued the confirmed commit. If <persist> is in the confirmed commit operation, a follow-up commit and the confirming commit can be on any session. However, they must include a <persist-id> element with a value equal to the value of the <persist> element in the confirmed commit. The <persist> element cannot be changed through a follow-up confirmed commit. |
| <persist-id> | Issues a follow-up confirmed commit or the confirming commit from any session, using the same token from the <persist> element of the confirmed commit. The <persist-id> element cannot be changed through a follow-up confirmed commit. |

| Parameter | Description |
|------------------------|--|
| <configuration-region> | Optional. Specifies the configuration-region to commit. |

- If <persist> is specified in the confirmed commit, the configuration changes are rolled back only if the timeout expires before a confirming commit is received. The confirming commit must include a <persist-id> tag with a value equal to the value of the <persist> tag contained in the confirmed commit.
- If the NETCONF session that initiated the confirmed commit is closed while waiting for the confirming commit (for example, disconnected), SR OS restores the configuration to its state before the confirmed commit was issued. This is valid only if <persist> was not defined in the confirmed commit. If a follow-up confirmed commit is issued before the timer expires, the timer is reset to the new value.
- The confirming commit and the follow-up confirmed commit cannot introduce additional changes to the configuration. The <cancel-commit> operation is supported. It can cancel an ongoing confirmed commit (that is, cancel the timer and rollback the changes introduced with the confirmed commit).
- Without the <persist> parameter, the <cancel-commit> operation must be issued in the same session that issued the confirmed commit.
- If the configuration changes involve changing the configuration-mode to classic, a confirmed commit should not be used to commit those configuration changes, as SR OS would switch to classic mode before sending the second commit.

See [Table 26: Protocol operations and level of support in Nokia SR OS NETCONF servers](#) for more information.

5.2.3.9 <discard-changes>

The <discard-changes> operation causes the <candidate> datastore to revert to match the <running> datastore and discard any uncommitted configuration changes.

To discard BOF configuration changes, the "bof" <configuration-region> must be specified within the <discard-changes> RPC. For example:

```
<?xml version="1.0" encoding="UTF-8"?>
<rpc message-id="101" xmlns="urn:ietf:params:xml:ns:netconf:base:1.0">
  <discard-changes>
    <configuration-region xmlns="urn:nokia.com:sros:ns:yang:sr:ietf-netconf-
augments">
      bof
    </configuration-region>
  </discard-changes>
</rpc>
]]>]]>
```

To discard debug configuration changes, the "debug" <configuration-region> must be specified within the <discard-changes> RPC. For example:

```
<?xml version="1.0" encoding="UTF-8"?>
<rpc message-id="101" xmlns="urn:ietf:params:xml:ns:netconf:base:1.0">
  <discard-changes>
    <configuration-region xmlns="urn:nokia.com:sros:ns:yang:sr:ietf-netconf-
augments">
      debug
    </configuration-region>
  </discard-changes>
</rpc>
]]>]]>
```



```

        </discard-changes>
</rpc>
]]>]]>

```

To discard LI configuration changes, the "li" <configuration-region> must be specified within the <discard-changes> RPC. For example:

```

<discard-changes>
  <configuration-region xmlns="urn:nokia.com:sros:ns:yang:sr:ietf-netconf-augments">
    li
  </configuration-region>
</discard-changes>

```

The <discard-changes> RPC can only be used with LI configuration changes if all of the following conditions are true.

- The NETCONF user is a LI user.
- The NETCONF session has an exclusive lock on the LI configuration region and <candidate> datastore.
- The specified <configuration-region> is "li".
- The YANG modules used are the Nokia SR OS YANG modules.

If any of the preceding conditions are false, SR OS returns an error.

See [Table 26: Protocol operations and level of support in Nokia SR OS NETCONF servers](#) for more information.

5.2.3.10 <validate>

The following is the list of supported :validate operations.

The validate:1.1 and :validate:1.0 capabilities are advertised in the NETCONF server <hello> as the following:

```
<capability>urn:ietf:params:netconf:capability:validate:1.0</capability>
```

```
<capability>urn:ietf:params:netconf:capability:validate:1.1</capability>
```

To validate the BOF configuration, the "bof" <configuration-region> must be specified within the <validate> <source>. For example:

```

<?xml version="1.0" encoding="UTF-8"?>
<rpc message-id="101" xmlns:nc="urn:ietf:params:xml:ns:netconf:base:1.0">
  <validate>
    <source>
      <configuration-region xmlns="urn:nokia.com:sros:ns:yang:sr:ietf-netconf-
augments">
        bof
      </configuration-region>
      <candidate/>
    </source>
  </validate>
</rpc>
]]>]]>

```

To validate the debug configuration, the "debug" <configuration-region> must be specified within the <validate> <source>. For example:

```
<?xml version="1.0" encoding="UTF-8"?>
<rpc message-id="101" xmlns:nc="urn:ietf:params:xml:ns:netconf:base:1.0">
  <validate>
    <source>
      <configuration-region xmlns="urn:nokia.com:sros:ns:yang:sr:ietf-netconf-
augmentations">
        debug
      </configuration-region>
    </source>
  </validate>
</rpc>
]]>]]>
```

To validate the LI configuration, the "li" <configuration-region> must be specified within the <validate> <source>. For example:

```
<validate>
  <source>
    <configuration-region xmlns="urn:nokia.com:sros:ns:yang:sr:ietf-netconf-augments">
      li
    </configuration-region>
  </source>
</validate>
```

Alternatively, the <source> can be specified in the format of "configuration-region"-<datastore>. For example:

```
<validate>
  <source>
    <li-candidate xmlns="urn:nokia.com:sros:ns:yang:sr:ietf-netconf-augments" />
  </source>
</validate>
```

When both the <configuration-region> and the "configuration-region"-<datastore> format are used, SR OS applies the last tag used in the XML request. For example:

```
<validate>
  <source>
    <configuration-region xmlns="urn:nokia.com:sros:ns:yang:sr:ietf-netconf-augments">
      configure
    </configuration-region>
    <li-candidate xmlns="urn:nokia.com:sros:ns:yang:sr:ietf-netconf-augments" />
  </source>
</validate>
```

In the preceding example, the <validate> is used on the "li" <candidate> datastore.

See [Table 26: Protocol operations and level of support in Nokia SR OS NETCONF servers](#) for more information.

5.2.3.11 <get-schema>

A <get-schema> operation is supported for explicit schema retrieval using NETCONF. See [NETCONF monitoring](#) for more information.

See [Table 26: Protocol operations and level of support in Nokia SR OS NETCONF servers](#) for more details.

5.2.3.12 <get-data>

A <get-data> operation is similar to a <get-config> operation. When applied to the `running` or `candidate` datastores, the <get-data> operation returns `config false` YANG nodes because the `running` and `candidate` datastores are configuration datastores (meaning they contain configuration data only and not state data).

You can apply a <get-data> operation to the `intended` datastore, but you cannot apply other non-NMDA compliant operations such as <get> and <get-config>. The `intended` datastore returns the data expanded with any templated configuration from configuration groups. The `intended` datastore is also a configuration datastore and returns `config false` YANG nodes only.

You can apply a <get-data> operation to the `operational` datastore, but you cannot apply other non-NMDA compliant operations, such as <get> and <get-config>. See [Operational datastore](#) for more information about the operational datastore.

The <get-data> operation supports the optional <config-filter> argument to restrict the output to `config true` or `config false` YANG nodes.

See [Table 26: Protocol operations and level of support in Nokia SR OS NETCONF servers](#) for more details.

The optional proprietary <format> argument is supported. See [Output format selection](#) for more information.

See [Output format tag](#) for an example of <get-data> request and response messages.

5.2.3.12.1 Output format tag

The following example shows the <get-data> operation combined with a subtree filter and requests the output in the MD-CLI format.

Example: MD-CLI format

```
<rpc message-id="101" xmlns="urn:ietf:params:xml:ns:netconf:base:1.0" xmlns:yang=
"urn:ietf:params:xml:ns:yang:1">
  <get-data xmlns="urn:ietf:params:xml:ns:yang:ietf-netconf-nmda"
    xmlns:ds="urn:ietf:params:xml:ns:yang:ietf-datastores">
    <format xmlns="urn:nokia.com:sros:ns:yang:sr:ietf-netconf-nmda-augments">
      md-cli
    </format>
    <datastore>ds:running</datastore>
    <subtree-filter>
      <configure xmlns="urn:nokia.com:sros:ns:yang:sr:conf">
        <system>
          <management-interface>
            <netconf/>
          </management-interface>
        </system>
      </configure>
    </subtree-filter>
  </get-data>
</rpc>
```

```

    </configure>
  </subtree-filter>
</get-data>
</rpc>
]]>]]>

```

The following example shows the reply.

Example: MD-CLI format reply

```

<?xml version="1.0" encoding="UTF-8"?>
<rpc-reply message-id="101" xmlns="urn:ietf:params:xml:ns:netconf:base:1.0" xmlns:yang=
"urn:ietf:params:xml:ns:yang:1">
  <data xmlns="urn:ietf:params:xml:ns:yang:ietf-netconf-nmda">
    configure {
      system {
        management-interface {
          netconf {
            admin-state enable
            auto-config-save true
            capabilities {
              candidate true
            }
          }
        }
      }
    }
  </data>
</rpc-reply>
]]>]]>

```

The following example shows the <get-data> operation combined with a subtree filter and requests the output in the JSON IETF format.

Example: JSON IETF format

```

<rpc message-id="101" xmlns="urn:ietf:params:xml:ns:netconf:base:1.0" xmlns:yang=
"urn:ietf:params:xml:ns:yang:1">
  <get-data xmlns="urn:ietf:params:xml:ns:yang:ietf-netconf-nmda"
    xmlns:ds="urn:ietf:params:xml:ns:yang:ietf-datastores">
    <format xmlns="urn:nokia.com:sros:ns:yang:sr:ietf-netconf-nmda-augments">
      json
    </format>
    <datastore>ds:running</datastore>
    <subtree-filter>
      <configure xmlns="urn:nokia.com:sros:ns:yang:sr:conf">
        <system>
          <management-interface>
            <netconf/>
          </management-interface>
        </system>
      </configure>
    </subtree-filter>
  </get-data>
</rpc>
]]>]]>

```

The following example shows the reply.

Example: JSON IETF format reply

```

<?xml version="1.0" encoding="UTF-8"?>

```

```

<rpc-reply message-id="101" xmlns="urn:ietf:params:xml:ns:netconf:base:1.0" xmlns:yang=
"urn:ietf:params:xml:ns:yang:1">
  <data xmlns="urn:ietf:params:xml:ns:yang:ietf-netconf-nmda">
    {
      "nokia-conf:configure": {
        "system": {
          "management-interface": {
            "netconf": {
              "admin-state": "enable",
              "auto-config-save": true,
              "capabilities": {
                "candidate": true
              }
            }
          }
        }
      }
    }
  </data>
</rpc-reply>
]]>]]>

```

5.2.3.12.2 Displaying shared model management configuration

When configuring the router using Nokia and third-party YANG models such as OpenConfig, you can use the `<with-managed/>` augment and `nokia-attr:managed` attribute to display which elements the Nokia and third-party YANG models manage. This helps determine if multiple models attempt to manage the same element. For example, if the `<get-data>` RPC for the operational datastore includes the `<with-managed/>` augment, the RPC reply displays the `nokia-attr:managed` attribute for each configuration element.

The `<managed-filter>` augment selects the model that manages the elements, which then limits the output to that model. The following `<managed-filter>` values indicate which model is managing a configuration:

- **nokia** — Nokia model
- **openconfig** — OpenConfig model
- **openconfig-nokia** — both OpenConfig and Nokia models

See [OpenConfig YANG data models](#) for more information about OpenConfig models.

The following example shows the `<get-data>` operation combined with the `<with-managed/>` augment. The example also shows that a `<subtree-filter/>` is applied to limit the output.

Example: `<with-managed/>` augment in a `<get-data>` RPC

```

<rpc message-id="100" xmlns="urn:ietf:params:xml:ns:netconf:base:1.0">
  <get-data xmlns="urn:ietf:params:xml:ns:yang:ietf-netconf-nmda" xmlns:ds=
"urn:ietf:params:xml:ns:yang:ietf-datastores">
    <datastore>ds:operational</datastore>
    <with-managed xmlns="urn:nokia.com:sros:ns:yang:sr:ietf-netconf-nmda-augments"/>
    <subtree-filter>
      <configure xmlns="urn:nokia.com:sros:ns:yang:sr:conf">
        <log>
          <syslog/>
        </log>
      </configure>
    </subtree-filter>
  </get-data>
</rpc>

```

```
]]>]]>
```

The following example shows the reply.

Example: nokia-attr:managed attribute in an RPC reply

```
<rpc-reply message-id="100" xmlns="urn:ietf:params:xml:ns:netconf:base:1.0">
  <data xmlns="urn:ietf:params:xml:ns:yang:ietf-netconf-nmda">
    <configure xmlns="urn:nokia.com:sros:ns:yang:sr:conf" xmlns:nokia-attr="urn:nokia.com:sros:ns:yang:sr:attributes">
      <log nokia-attr:managed="openconfig-nokia">
        <syslog nokia-attr:managed="openconfig-nokia">
          <syslog-name>oc_rem_1.1.1.2</syslog-name>
          <address nokia-attr:managed="openconfig-nokia">1.1.1.2</address>
          <facility nokia-attr:managed="nokia">local7</facility>
          <severity nokia-attr:managed="nokia">emergency</severity>
          <log-prefix nokia-attr:managed="openconfig">1.1.1.3</log-prefix>
          <port nokia-attr:managed="openconfig-nokia">540</port>
        </syslog>
        <syslog nokia-attr:managed="openconfig">
          <syslog-name>oc_rem_192.168.0.10</syslog-name>
          <address nokia-attr:managed="openconfig">192.168.0.10</address>
          <facility nokia-attr:managed="nokia">local7</facility>
          <severity nokia-attr:managed="nokia">info</severity>
          <log-prefix nokia-attr:managed="openconfig">1.1.1.3</log-prefix>
          <port nokia-attr:managed="openconfig">456</port>
        </syslog>
      </log>
    </configure>
  </data>
</rpc-reply>
]]>]]>
```

The following example shows the `<get-data>` operation combined with the `<with-managed/>` and `<managed-filter>` augments to display elements that are managed by Nokia and OpenConfig models. The example also shows that a `<subtree-filter/>` is also applied to limit the output.

Example: `<with-managed/>` and `<managed-filter>` augments in a `<get-data>` RPC

```
<rpc message-id="101" xmlns="urn:ietf:params:xml:ns:netconf:base:1.0">
  <get-data xmlns="urn:ietf:params:xml:ns:yang:ietf-netconf-nmda" xmlns:ds="urn:ietf:params:xml:ns:yang:ietf-datstores">
    <datastore>ds:operational</datastore>
    <with-managed xmlns="urn:nokia.com:sros:ns:yang:sr:ietf-netconf-nmda-augments"/>
    <managed-filter xmlns="urn:nokia.com:sros:ns:yang:sr:ietf-netconf-nmda-augments">openconfig-nokia</managed-filter>
    <subtree-filter>
      <configure xmlns="urn:nokia.com:sros:ns:yang:sr:conf">
        <log>
          <syslog/>
        </log>
      </configure>
    </subtree-filter>
  </get-data>
</rpc>
]]>]]>
```

The following example shows the reply.

Example: Filtered nokia-attr:managed attribute in an RPC reply

```
<rpc-reply message-id="101" xmlns="urn:ietf:params:xml:ns:netconf:base:1.0">
  <data xmlns="urn:ietf:params:xml:ns:yang:ietf-netconf-nmda">
    <configure xmlns="urn:nokia.com:sros:ns:yang:sr:conf" xmlns:nokia-attr=
"urn:nokia.com:sros:ns:yang:sr:attributes">
      <log nokia-attr:managed="openconfig-nokia">
        <syslog nokia-attr:managed="openconfig-nokia">
          <syslog-name>oc_rem_1.1.1.2</syslog-name>
          <address nokia-attr:managed="openconfig-nokia">1.1.1.2</address>
          <port nokia-attr:managed="openconfig-nokia">540</port>
        </syslog>
      </log>
    </configure>
  </data>
</rpc-reply>
]]>]]>
```

5.2.4 Datastore and operation combinations

The following table lists the operations supported by the datastores.

Table 29: Datastore and operation combinations

| Operation | Datastore | | | |
|--------------------------|-----------|-------------|------------|---------------|
| | <running> | <candidate> | <intended> | <operational> |
| <edit-config> | | ✓ | | |
| <get-config> | ✓ | ✓ | | |
| <get-data> ¹⁰ | ✓ | ✓ | ✓ | ✓ |

The <get> RPC returns data that has the config field set to false in the YANG model, and data from the <running> datastore that has the config field set to true in the YANG model.

5.2.5 Output format selection

The SR OS NETCONF implementation provides an optional proprietary <format> argument for the <get>, <get-config>, and <get-data> NETCONF operations and the <md-compare> YANG-modeled operation.

The <format> argument allows the operator to display the resultant data in either the XML (default), JSON IETF, or MD-CLI format.

The supported options for the <format> argument are as follows:

- xml
- json
- md-cli

¹⁰ The use of <get-data> and the <intended> or <operational> datastores requires **nmda-support** to be enabled.



Note: See [<get>](#), [<get-config>](#), and [<get-data>](#) for usage examples of the [<format>](#) option.

The supported options for the [<format>](#) argument are as follows for the [<md-compare>](#) YANG-modeled operation:

- xml
- md-cli



Note: See [<md-compare> YANG-modeled operation](#) for usage examples.

5.2.6 Private candidates over NETCONF

The SR OS NETCONF implementation provides a proprietary function to operate a specific NETCONF session in private candidate mode. This provides the ability for NETCONF (and CLI) sessions to cohabit with minimal disruption to each other because the sessions often configure entirely separate sections of the overall device configuration.

Setting up, configuring, and discarding private candidates

Sending the `urn:nokia.com:nc:pc` client capability from the NETCONF client to the NETCONF server in the `<hello>` message establishes the private candidate mode. The private candidate mode applies for the duration of a specific NETCONF session. The following example shows how to send the client capability.

```
<?xml version="1.0" encoding="UTF-8"?>
<hello xmlns="urn:ietf:params:xml:ns:netconf:base:1.0">
  <capabilities>
    <capability>urn:ietf:params:netconf:base:1.0</capability>
    <capability>urn:nokia.com:nc:pc</capability>
  </capabilities>
</hello>
]]>]]>
```

The server sends no specific response to the `<hello>` message. From this point on, the session is in private candidate mode.

Private candidate mode operates in the same way as the default global candidate mode in many respects. Most of the RPCs and NETCONF operations that can be used remain the same.

Whenever a NETCONF operation references the candidate configuration datastore, a private candidate configuration is used. The system creates a private candidate configuration as a copy of the running configuration when the first RPC that requires a candidate configuration is used. The system also creates a baseline candidate configuration at this point. The baseline candidate configuration acts as a reference for identifying changes that the NETCONF client has made in the private candidate.

The following RPCs do not require a candidate and therefore do not trigger the creation of a candidate:

- `<get-schema>`
- `<validate>` when used without specifying a source configuration datastore
- any `<action>` RPC that does not require a candidate configuration

Every NETCONF session running in private candidate mode has its own private candidate configuration. If multiple NETCONF clients are used to configure specific sections of the configuration, the private

candidate mode provides improvements in performance and operation because of the ability to edit configuration changes without locking the candidate configuration datastore.

See "Candidate configuration modes" in the *7450 ESS, 7750 SR, 7950 XRS, and VSR MD-CLI User Guide* for more information.

When a configuration is edited over NETCONF in the private candidate, MD-CLI users do not see these configuration changes in the global candidate configuration datastore as these changes are in the private candidate belonging to the specific NETCONF session.

When a NETCONF session running in private candidate mode sends a <commit> RPC, the SR OS node performs an update and subsequently a commit operation. See "Multiple simultaneous candidate configurations" in the *7450 ESS, 7750 SR, 7950 XRS, and VSR MD-CLI User Guide* for more information.

In the unlikely event that a collision in the configuration occurs because other users configure the same area of the configuration at the same time, the update operation in this process fails and therefore the <commit> RPC also fails. This update failure ensures the following:

- The user is aware of the conflict.
- The integrity of the operational configuration on the node remains intact.
- No unintended configuration changes resulting from any other users' input are made.

If the <commit> RPC fails for the above reason, sending the <commit> again may resolve the issue. If the issue is not resolved, the session must be restarted.

The <commit> RPC over a NETCONF session running in private candidate mode does not accept the **persist-id** option.

Closing a private candidate NETCONF session, either through disconnection or the <close-session> operation, discards the private candidate and all uncommitted configuration changes.

Locking private candidates in NETCONF

When using the private candidate mode over NETCONF, it is less likely that the candidate configuration needs to be locked. There can still be specific operational situations where the operator wants to use the private candidate functionality and temporarily restrict all other users from changing the node's running configuration.

In this case, the operator can use the <lock> RPC as they would in the usual operating mode for NETCONF.

If an operator issues the <lock> RPC, the following applies:

- The private candidate configuration is promoted to a private-exclusive candidate configuration within SR OS.
- Any configuration changes that exist in the operator's private candidate are retained.
- No other users on the SR OS node can commit any configuration changes.

When the operator who issued the <lock> RPC wants to allow other users to commit configuration changes again, the operator issues the <unlock> RPC.

If the operator issues the <unlock> RPC, the following applies:

- The other users get the rights to commit configuration changes again.
- Any uncommitted configuration changes in the private-exclusive candidate configuration are retained.
- The operator's private-exclusive candidate configuration is demoted back to private candidate status.



Note: In the default NETCONF mode (global candidate) and in the MD-CLI, uncommitted changes to an exclusive candidate configuration are discarded when the candidate is unlocked.

5.2.7 General NETCONF behavior

Using Ctrl-c in a NETCONF session will immediately terminate the session.

The SR OS NETCONF implementation supports XML namespaces (xmlns).

If an invalid namespace is specified within the client hello message, no error will be returned because the NETCONF server is still waiting for the client to send a valid <hello/>. For further NETCONF requests (without sending a correct hello message), even though correct, SR OS returns an error indicating that "Common base capability not found."

SR OS checks for correct element namespaces on input and returns an error if they are incorrect.

An <edit-config> request must specify which data model (for example, Nokia SR OS YANG modules) is being used in the top-level <configure> element.

- SR OS accepts a single namespace at the top-level <configure> element. For example:

```
<configure xmlns="urn:nokia.com:sros:ns:yang:sr:conf">
  <system>
    . . . .
```

- The NETCONF client can declare the namespaces with prefixes at the <rpc> element and use the corresponding prefixes later in the request message <configure/> block.
- SR OS returns an error if the request contains one or more incorrect namespaces.

The chunked framing mechanism is supported in addition to the EOM mechanism. As per RFC 6242, Section 4.1 - Framing Protocol, "[...] If the :base:1.1 capability is advertised by both peers, the chunked framing mechanism (see Section 4.2) is used for the remainder of the NETCONF session. Otherwise, the end-of-message-based mechanism is used." See [Chunked frame mechanism](#) for more information.

Handling of default data (for example, **info** vs **info detail**) uses the mechanisms described in RFC 6243. The SR OS NETCONF server supports the "explicit" method as the default for the Nokia SR OS YANG modules. It also supports the "report-all" method.

The advertised capability changes depending on which YANG modules are enabled or disabled in SR OS. For example, when Nokia modules are enabled and all other modules are disabled, the following capability is advertised:

```
<capability>urn:ietf:params:netconf:capability:with-defaults:1.0?basic-mode=explicit&also-supported=report-all</capability>
```

A **debug system netconf info** command can be used to dump NETCONF debug message streams. Note that in case of failure, the current logging levels do not mark the messages as errors or warnings.

5.2.7.1 Multiple use of standard NETCONF namespace

The following example shows the standard NETCONF namespace "urn:ietf:params:xml:ns:netconf:base:1.0" is used more than once in the <rpc> element.

```
<?xml version="1.0" encoding="UTF-8"?>
<rpc message-id="101"
  xmlns="urn:ietf:params:xml:ns:netconf:base:1.0"
```

```

xmlns:alu="urn:ietf:params:xml:ns:netconf:base:1.0">
  <get-config>
    <source> <running/> </source>
    <filter>
      <configure xmlns="urn:nokia.com:sros:ns:yang:sr:conf">
        <router>
          <router-name>Base</router-name>
          <interface>
            <interface-name>system</interface-name>
          </interface>
        </router>
      </configure>
    </filter>
  </get-config>
</rpc>
]]>]]>

```

In the following reply, the namespace is accepted and no error message is returned.

```

<?xml version="1.0" encoding="UTF-8"?>
<rpc-reply message-id="101" xmlns="urn:ietf:params:xml:ns:netconf:base:1.0"
  xmlns:alu="urn:ietf:params:xml:ns:netconf:base:1.0">
  <data>
    <configure xmlns="urn:nokia.com:sros:ns:yang:sr:conf" xmlns:nokia-attr=
"urn:nokia.com:sros:ns:yang:sr:attributes">
      <router>
        <router-instance>Base</router-instance>
        <interface>
          <interface-name>system</interface-name>
          <admin-state>disable</admin-state>
        </interface>
      </router>
    </configure>
  </data>
</rpc-reply>
]]>]]>

```

5.2.7.2 Non-default NETCONF base namespace

The following example shows an allowed non-default NETCONF base namespace used in the <rpc> element.

```

<?xml version="1.0" encoding="UTF-8"?>
<rpc message-id="101"
  xmlns="urn:ietf:params:xml:ns:netconf:base:1.0"
  xmlns:alu="urn:nokia.com:sros:ns:yang:sr:conf">
  <get-config>
    <source> <running/> </source>
    <filter>
      <configure xmlns="urn:nokia.com:sros:ns:yang:sr:conf">
        <router>
          <router-name>Base</router-name>
          <interface>
            <interface-name>system</interface-name>
          </interface>
        </router>
      </configure>
    </filter>
  </get-config>
</rpc>

```

```
]]>]]>
```

In the following reply, a non-NETCONF base namespace is allowed and no error is returned.

```
<?xml version="1.0" encoding="UTF-8"?>
<rpc-reply message-id="101" xmlns="urn:ietf:params:xml:ns:netconf:base:1.0"
xmlns:alu="urn:nokia.com:sros:ns:yang:sr:conf">
  <data>
    <configure xmlns="urn:nokia.com:sros:ns:yang:sr:conf" xmlns:nokia-attr=
"urn:nokia.com:sros:ns:yang:sr:attributes">
      <router>
        <router-name>Base</router-name>
        <interface>
          <interface-name>system</interface-name>
          <admin-state>disable</admin-state>
        </interface>
      </router>
    </configure>
  </data>
</rpc-reply>
]]>]]>
```

5.2.7.3 Invalid NETCONF namespace declaration

The following example shows an invalid NETCONF namespace declared in the <rpc> element.

```
<?xml version="1.0" encoding="UTF-8"?>
<rpc message-id="101"
xmlns="urn:ietf:params:xml:ns:netconf:base:1.0"
xmlns:alu="urn:alcatel-lucent.com:sros:ns:yang:sr:conf">
  <get-config>
    <source><running/></source>
    <filter>
      <configure xmlns="urn:nokia.com:sros:ns:yang:sr:conf">
        <router>
          <router-name>Base</router-name>
          <interface>
            <interface-name>system</interface-name>
          </interface>
        </router>
      </configure>
    </filter>
  </get-config>
</rpc>
]]>]]>
```

In the following reply, SR OS returns an error.

```
<?xml version="1.0" encoding="UTF-8"?>
<rpc-reply message-id="101" xmlns="urn:ietf:params:xml:ns:netconf:base:1.0"
xmlns:alu="urn:alcatel-lucent.com:sros:ns:yang:sr:conf">
  <rpc-error>
    <error-type>protocol</error-type>
    <error-tag>unknown-namespace</error-tag>
    <error-severity>error</error-severity>
    <error-message>
      An unexpected namespace is present.
    </error-message>
    <error-info>
      <bad-element>rpc</bad-element>
    </error-info>
  </rpc-error>
</rpc-reply>
```

```

    <bad-namespace>urn:alcatel-lucent.com:sros:ns:yang:sr:conf</bad-namespace>
  </error-info>
</rpc-error>
</rpc-reply>
]]>]]>

```

5.2.7.4 Non-default NETCONF namespace or prefix declaration in a child tag

The following example shows a non-default NETCONF namespace or prefix declared in any child tag overriding the one declared under the <rpc> tag.

```

<?xml version="1.0" encoding="UTF-8"?>
<rpc message-id="101"
xmlns="urn:ietf:params:xml:ns:netconf:base:1.0"
xmlns:alu="urn:ietf:params:xml:ns:netconf:base:1.0">
  <get-config>
    <source> <running/> </source>
    <filter>
      <configure xmlns="urn:nokia.com:sros:ns:yang:sr:conf">
        <router>
          <router-name>Base</router-name>
          <interface xmlns:alu="urn:nokia.com:sros:ns:yang:sr:conf">
            <alu:interface-name>system</alu:interface-name>
          </interface>
        </router>
      </configure>
    </filter>
  </get-config>
</rpc>
]]>]]>

```

In the following reply, the non-standard NETCONF namespace or prefix used in the tag is ignored.

```

<?xml version="1.0" encoding="UTF-8"?>
<rpc-reply message-id="101" xmlns="urn:ietf:params:xml:ns:netconf:base:1.0"
xmlns:alu="urn:ietf:params:xml:ns:netconf:base:1.0">
  <data>
    <configure xmlns="urn:nokia.com:sros:ns:yang:sr:conf">
      <router>
        <router-name>Base</router-name>
        <interface>
          <interface-name>system</interface-name>
          <admin-state>disable</admin-state>
        </interface>
      </router>
    </configure>
  </data>
</rpc-reply>
]]>]]>

```

5.2.7.5 Chunked frame mechanism

The following example shows a chunked message.

```

#359
<?xml version="1.0" encoding="UTF-8"?><rpc message-id="101"
xmlns="urn:ietf:params:xml:ns:netconf:base:1.0"><get-config><source><running/></source><filter>

```

```
<configure xmlns="urn:nokia.com:sros:ns:yang:sr:conf"><router><router-name>Base</router-name>
<interface><interface-name>system</interface-name></interface></router></configure></filter></
get-
config></rpc>
##
```

The following example shows the reply.

```
#38
<?xml version="1.0" encoding="UTF-8"?>
#1
#10
<rpc-reply
#17
  message-id="101"
#48
  xmlns="urn:ietf:params:xml:ns:netconf:base:1.0"
#1
  >
#1
#9
  <data
#1
  >
#1
#63
    <configure xmlns="urn:nokia.com:sros:ns:yang:sr:conf">
#21
      <router>
#48
        <router-name>Base</router-name>
#28
        <interface>
#60
          <interface-name>system</interface-name>
#55
          <admin-state>disable</admin-state>
#29
        </interface>
#22
      </router>
#21
    </configure>
#11
  </data>
#1
#12
</rpc-reply>
##
```

5.2.8 Establishing a NETCONF session

The following example shows a client on a Linux PC initiating a connection to an SR OS NETCONF server. The SSH session must be invoked using an SSH subsystem (as recommended in RFC 6242).

```
ssh user_name@netconf_server_ip -p port_number -s netconf
```

The following example shows an exchange of hello messages, which include advertisement of capabilities.

From the SR OS server:

```
<?xml version="1.0" encoding="UTF-8"?>
<hello xmlns="urn:ietf:params:xml:ns:netconf:base:1.0">
  <capabilities>
    <capability>urn:ietf:params:netconf:base:1.0</capability>
    <capability>urn:ietf:params:netconf:base:1.1</capability>
    ...
  </capabilities>
  <session-id>20</session-id>
</hello>
]]>]]>
```

A NETCONF client can reply with a hello message as shown in either of the following:

```
<?xml version="1.0" encoding="UTF-8"?>
<hello xmlns="urn:ietf:params:xml:ns:netconf:base:1.0">
  <capabilities>
    <capability>urn:ietf:params:netconf:base:1.0</capability>
  </capabilities>
</hello>
]]>]]>
```

```
<?xml version="1.0" encoding="UTF-8"?>
<hello xmlns="urn:ietf:params:xml:ns:netconf:base:1.0">
  <capabilities>
    <capability>urn:ietf:params:netconf:base:1.1</capability>
  </capabilities>
</hello>
]]>]]>
```

5.2.8.1 Checking NETCONF status

The following example shows a <get-config> request on the <running> datastore that checks on whether NETCONF is shut down or not on the router.

```
<?xml version="1.0" encoding="UTF-8"?>
<rpc message-id="101" xmlns="urn:ietf:params:xml:ns:netconf:base:1.0">
  <get-config>
    <source><running/></source>
    <filter>
      <configure xmlns="urn:nokia.com:sros:ns:yang:sr:conf">
        <system>
          <management-interface>
            <netconf/>
          </management-interface>
        </system>
      </configure>
    </filter>
  </get-config>
</rpc>
]]>]]>
```

The following example shows the reply.

```
<?xml version="1.0" encoding="UTF-8"?>
<rpc-reply message-id="101" xmlns="urn:ietf:params:xml:ns:netconf:base:1.0">
```

```

<data>
  <configure xmlns="urn:nokia.com:sros:ns:yang:sr:conf">
    <system>
      <management-interface>
        <netconf>
          <admin-state>enable</admin-state>
          <auto-config-save>true</auto-config-save>
        </netconf>
      </management-interface>
    </system>
  </configure>
</data>
</rpc-reply>
]]>]]>

```

5.2.8.2 Retrieving system configurations, QoS, and log branches

The following example shows a <get-config> request on the <candidate> datastore to get the full configurations of the system, QoS, and log branches.

```

<?xml version="1.0" encoding="UTF-8"?>
<rpc message-id="101" xmlns="urn:ietf:params:xml:ns:netconf:base:1.0">
  <get-config>
    <source><candidate/></source>
    <filter>
      <configure xmlns="urn:nokia.com:sros:ns:yang:sr:conf">
        <system>
          </system>
        </configure>
        <configure xmlns="urn:nokia.com:sros:ns:yang:sr:conf">
          <log/>
        </configure>
      </filter>
    </get-config>
  </rpc>
]]>]]>

```

The following example shows the reply.

```

<?xml version="1.0" encoding="UTF-8"?>
<rpc-reply message-id="101" xmlns="urn:ietf:params:xml:ns:netconf:base:1.0">
  <data>
    <configure xmlns="urn:nokia.com:sros:ns:yang:sr:conf">
      <log>
        <filter>
          <filter-id>1001</filter-id>
          <entry>
            <entry-id>10</entry-id>
            <description>events of major severity or higher</description>
            <action>forward</action>
            <match>
              <severity>
                <gte>major</gte>
              </severity>
            </match>
          </entry>
        </filter>
        ...
        ...
      </log-id>

```



```

        <id>101</id>
        <destination>
          <netconf>
          </netconf>
        </destination>
      </log-id>
    </log>
  </system>
  <name>Test</name>
  <dns>
    <address-pref>ipv4-only</address-pref>
  </dns>
  ...
  ...
</system>
</configure>
</data>
</rpc-reply>
]]>]]>

```

5.2.8.3 Creating an Epipe service

The following example shows an <edit-config> request on the <candidate> datastore to create a basic Epipe service.

```

<?xml version="1.0" encoding="UTF-8"?>
<rpc message-id="101" xmlns="urn:ietf:params:xml:ns:netconf:base:1.0">
  <edit-config>
    <target><candidate/></target>
    <config>
      <configure xmlns="urn:nokia.com:sros:ns:yang:sr:conf">
        <service>
          <epipe>
            <service-name>CustDoc</service-name>
            <customer>1</customer>
            <service-mtu>1514</service-mtu>
          </epipe>
        </service>
      </configure>
    </config>
  </edit-config>
</rpc>
]]>]]>

```

The following example shows the reply.

```

<?xml version="1.0" encoding="UTF-8"?>
<rpc-reply message-id="101" xmlns="urn:ietf:params:xml:ns:netconf:base:1.0">
  <ok/>
</rpc-reply>
]]>]]>

```

5.2.8.4 Returning multiple errors

The following example shows SR OS returning multiple errors with the <commit>.

```

<?xml version="1.0" encoding="UTF-8"?>

```

```

<rpc message-id="101" xmlns="urn:ietf:params:xml:ns:netconf:base:1.0">
  <edit-config>
    <target><candidate/></target>
    <config>
      <configure xmlns="urn:nokia.com:sros:ns:yang:sr:conf">
        <router>
          <router-name>Base</router-name>
          <ldp>
            <interface-parameters>
              <interface>
                <ip-int-name>xe-1/1/1</ip-int-name>
                <ipv4>
                  </ipv4>
              </interface>
              <interface>
                <ip-int-name>xe-1/2/1</ip-int-name>
                <ipv4>
                  </ipv4>
              </interface>
            </interface-parameters>
            <targeted-session>
              <peer>
                <ip-address>172.22.1.34</ip-address>
              </peer>
            </targeted-session>
            <tcp-session-parameters>
              <peer-transport>
                <ip-address>172.22.1.34</ip-address>
                <authentication-key>Ru4bf!n</authentication-key>
              </peer-transport>
            </tcp-session-parameters>
          </ldp>
        </router>
      </configure>
    </config>
  </edit-config>
</rpc>
]]>]]>

```

```

<?xml version="1.0" encoding="UTF-8"?>
<rpc-reply message-id="101" xmlns="urn:ietf:params:xml:ns:netconf:base:1.0">
  <ok/>
</rpc-reply>
]]>]]>

```

```

<?xml version="1.0" encoding="UTF-8"?>
<rpc message-id="101" xmlns="urn:ietf:params:xml:ns:netconf:base:1.0">
  <commit/>
</rpc>
]]>]]>

```

```

<?xml version="1.0" encoding="UTF-8"?>
<rpc-reply message-id="101" xmlns="urn:ietf:params:xml:ns:netconf:base:1.0">
  <rpc-error>
    <error-type>application</error-type>
    <error-tag>operation-failed</error-tag>
    <error-severity>error</error-severity>
    <error-path xmlns:a="urn:nokia.com:sros:ns:yang:sr:conf">
/a:configure/a:router[a:router-name=&quot;Base&quot;];/a:ldp/a:interface-parameters/
a:interface[a:ip-int-name=&quot;xe-1/1/1&quot;];
    </error-path>
    <error-message>

```

```

    MINOR: MGMT_CORE #224: Entry does not exist - configure router router-name
    &quot;Base&quot; interface interface-name
    &quot;xe-1/1/1&quot;;
    </error-message>
    <error-info>
      <err-element>interface</err-element>
    </error-info>
  </rpc-error>
</rpc-error>
  <error-type>application</error-type>
  <error-tag>operation-failed</error-tag>
  <error-severity>error</error-severity>
  <error-path xmlns:a="urn:nokia.com:sros:ns:yang:sr:conf">
/a:configure/a:router[a:router-name=&quot;Base&quot;];/a:ldp/a:interface-parameters/
a:interface[a:ip-int-name=&quot;xe-1/2/1&quot;];
  </error-path>
  <error-message>
    MINOR: MGMT_CORE #224: Entry does not exist - configure router router-name
    &quot;Base&quot; interface interface-name
    &quot;xe-1/2/1&quot;;
  </error-message>
  <error-info>
    <err-element>interface</err-element>
  </error-info>
</rpc-error>
</rpc-reply>
]]>]]>

```

5.3 NETCONF notifications

NETCONF notifications support is a standard IETF asynchronous notification delivery service for NETCONF that is specified in RFC 5277. SR OS allows log events to be output as NETCONF notifications. NETCONF is one of the output options for an event log (along with SNMP, syslog, and others).

The `:notification` capability and the `:interleave` capability are advertised in the SR OS NETCONF server `<hello>` as:

```

<capability>urn:ietf:params:netconf:capability:notification:1.0</capability>
<capability>urn:ietf:params:netconf:capability:interleave:1.0</capability>

```

The following are characteristics of the NETCONF notifications capabilities supported in SR OS:

- The `:notification` capability allows the SR OS NETCONF server can process a subscription and send event notifications to the NETCONF client.
- The `:interleave` capability allows the SR OS NETCONF server supports receiving, processing, and responding to NETCONF requests on the same NETCONF session that has an active notification subscription.
- A NETCONF client needs to maintain an open NETCONF session with the NETCONF server to receive NETCONF notifications.
- A NETCONF client can send a `<create-subscription>` RPC to the SR OS NETCONF server to start receiving notification messages.
- If the SR OS NETCONF server can satisfy the request, SR OS sends an `<OK>` element within the `<rpc-reply>`.
- If the SR OS NETCONF server cannot satisfy the request, SR OS sends an `<rpc-error>` element within the `<rpc-reply>`.

- Subscriptions are nonpersistent and their lifetime is defined by their NETCONF session (not maintained with a router reboot).
- An optional parameter that can be defined for a <create-subscription> RPC is [stream]. The following are characteristics of the [stream] parameter:
 - An event stream is a set of event notifications matching a specified forwarding criteria and available to the NETCONF clients for subscription.
 - A NETCONF session can subscribe to only one stream at a time.
 - One stream can be subscribed-to by many NETCONF sessions.
 - The SR OS NETCONF server maintains one or more event streams.
 - SR OS uses the SR OS event reporting framework for NETCONF notifications.
 - A log-id can be configured to be a NETCONF stream. A "netconf-stream" exists for each log-id to assign a NETCONF "stream" name to the log-id. A netconf-stream is unique per SR OS device. The netconf-stream must be configured with "to netconf" for subscriptions to be accepted. If a netconf-stream is changed, active subscriptions to the changed NETCONF stream name are terminated by SR OS.
 - There is one preconfigured stream with the netconf-stream set to "to netconf", that is, log-id 101. It is used by default if the [stream] parameter is not specified. The preconfigured stream is modifiable but not deletable.
 - Other streams can be configured using NETCONF or CLI. These streams are user-configured, which means that they are modifiable and can be deleted. A user-configured stream netconf-stream cannot be set to "to netconf" because "to netconf" is reserved for the preconfigured stream (that is, log-id 101).
 - When a NETCONF client tries to subscribe to the SNMP log-id or a non-configured log-id, SR OS returns an error.
 - SR OS supports a maximum number of 64 concurrent subscriptions to all streams.
 - Notifications can be filtered out using a log-id "filter" or using base-op for create-subscriptions RPC.
 - After the NETCONF server receives an SR OS event through a stream, a <notification> element is ready to be sent to all NETCONF sessions subscribed to that stream as per their filters.
- SR OS maps log events to the following NETCONF notifications. See [NETCONF notification examples](#) for more information.
 - **sros-config-change-event**

This notification contains information about configuration changes in classic format. The tmnxConfigModify, tmnxConfigCreate, and tmnxConfigDelete log events from the SYSTEM and SECURITY applications are mapped to this notification. For model-driven information about configuration changes, Nokia recommends you use ON_CHANGE telemetry (for example, a subscription to the YANG /configure path) or the netconf-config-change notification that follows.
 - **sros-state-change-event**

This notification contains information about state changes in classic format. The tmnxStateChange log event from the SYSTEM and SECURITY applications are mapped to this notification. For model-driven information about state changes, Nokia recommends you use ON_CHANGE telemetry (for example, a subscription to various YANG state paths).
 - **sros-command-accounting-event**

This notification contains information about the commands and operations performed by users in classic CLI and MD-CLI. Log events mapped to this notification include the `cli_*_io` events from the USER application and the `md_cli_io` and `md_cli_unauth_io` events from the SECURITY application.

- **sros-log-generic-event**

This notification contains information about non-LI SR OS log events in most protocols and feature areas. All log events that are not mapped to any other notifications in this list are mapped to the **sros-log-generic-event**.

- **netconf-config-change**

This is a notification based on the model-driven configuration change log events "mdConfigChange", "mdOcConfigChange", "mdBofConfigChange", and "mdDebugConfigChange" from the MGMT_CORE application. The notification is sent upon any configuration change that occurs in the running datastore by a model-driven management interface, using either the Nokia SR OS or OpenConfig data models, and in any configuration region except li (such as configure, bof, and debug). By default, the notification is disabled because all corresponding log events are also disabled by default. The notification uses the standard notification: `netconf-config-change` (as per RFC 6470) augmented with a value leaf.

A single configuration change may involve editing more than one object (target). Each log event contains only a single object edit. As a result, only one object (target) edit can exist per **netconf-config-change** notification. Bundling of edits in a single **netconf-config-change** notification does not occur.

- **sros-md-rpc-accounting-event**

This is a notification based on the NETCONF/gRPC local command accounting log events (the `netconf_auth`, `netconf_unauth`, `grpc_auth`, and `grpc_unauth` log events from the SECURITY application). This notification is sent upon receiving any RPC from a NETCONF/gRPC client. The NETCONF/gRPC local command accounting log events and NETCONF notification do not show the details of the configuration changes sent using the NETCONF/gRPC RPCs.

- SR OS supports the following Lawful Intercept (LI) NETCONF notifications.

- **sros-li-config-change-event**

This notification contains information about LI configuration changes in classic format. The `tmnxConfigModify`, `tmnxConfigCreate`, and `tmnxConfigDelete` LI log events from the LI application are mapped to this notification. For model-driven information about LI configuration changes, Nokia recommends you use the `netconf-li-config-change` notification described in the following bullets.

- **sros-li-state-change-event**

This notification contains information about LI state changes in classic format. The `tmnxStateChange` log event from the LI application is mapped to this notification.

- **sros-li-command-accounting-event**

This notification contains information about which LI user performed which commands and operations in classic CLI and MD-CLI. LI log events mapped to this notification include the `cli_*_io` events from the LI application as well as the `md_cli_io` and `md_cli_unauth_io` events from the LI application.

- **sros-li-log-generic-event**

This notification contains information about LI SR OS log events in most protocols and feature areas. All LI SR OS log events that are not mapped to any other notifications in this list are mapped to the **sros-li-log-generic-event**.

– **netconf-li-config-change**

This is a notification based on the model-driven LI configuration change log event (the "mdLiConfigChange" log event from the LI application). It is sent upon any LI configuration change that occurs in the running datastore by a model-driven management interface. By default, this notification is enabled, because the log event is also enabled by default.

– **sros-md-li-rpc-accounting-event**

This is a notification based on the NETCONF/gRPC local command accounting LI log events (the netconf_auth, netconf_unauth, grpc_auth, and grpc_unauth log events from the LI application). This notification is sent upon receiving any RPC from a NETCONF/gRPC client. The NETCONF/gRPC local command accounting LI log events and LI NETCONF notification provide basic information about which RPC/operation was requested and the associated user. They do not show the details of every configuration element changed in a NETCONF request.

In a <create-subscription>, a <filter> is an optional argument that is not supported by SR OS.

In a <create-subscription>, a <startTime> is an optional argument. This argument triggers the starting time of a replay. If it is not present, the subscription cannot be used to replay. A <startTime> cannot specify a time that is later than the current time (that is, in the future). SR OS supports timezones.

In a <create-subscription>, a <stopTime> is another optional argument. If this argument is not present, notifications continue to be sent until the subscription is terminated. A <stopTime> can specify a time that is later than the current time (that is, in the future). SR OS supports timezones.

A replay buffer is maintained by the SR OS server (per stream) and sorted by the order they were initially sent out (that is, by sequence-id, and not by timestamps).

- A replay request from the client causes stored events to be sent to the client for the specified time interval.
- A stream that supports replay is not expected to have an unlimited supply of saved notifications available to accommodate any replay request.
- The <startTime> and <stopTime> arguments specify when collections begin and end, respectively.
- A <replayComplete> notification is sent to indicate that all the replay notifications have been sent.
 - If a <stopTime> was specified, the session then becomes a normal NETCONF session, and the NETCONF server accepts <rpc> operations. A <notificationComplete> notification is expected after the <replayComplete> if a <stopTime> was specified. The following is an example of a session with a <stopTime> specified:

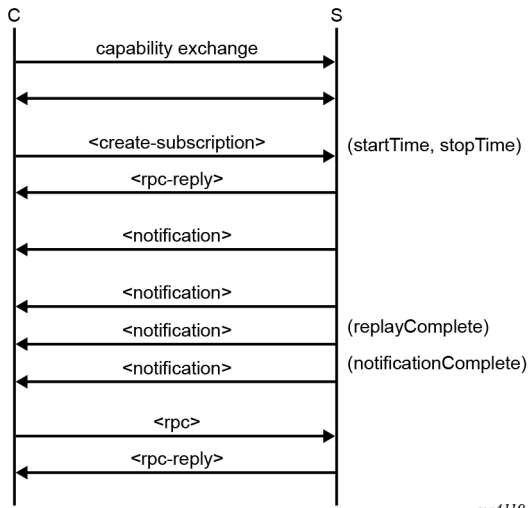

sw4119

- If a <stopTime> is not specified, the session continues to send notifications as they arise in the system. The following is an example of a session without a <stopTime> specified:

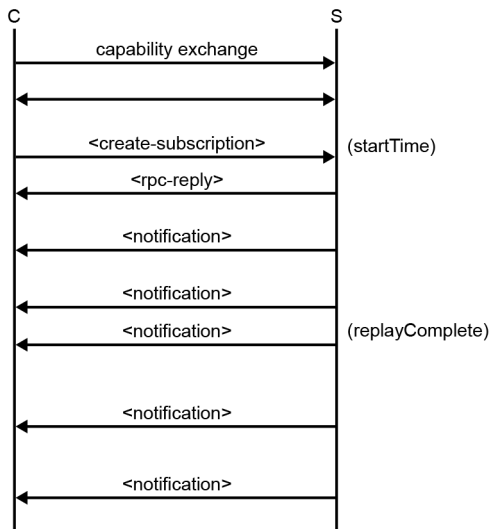

sw4120

- If neither <startTime> and <stopTime> arguments are present, no replay is present and notifications continue to be sent until the subscription is terminated.

5.3.1 NETCONF notification examples

This section provides examples of NETCONF notifications.

5.3.1.1 Example of <create-subscription> operation

The following example shows a <create-subscription> operation.

```
<?xml version="1.0" encoding="UTF-8"?>
```

```
<rpc message-id="101" xmlns="urn:ietf:params:xml:ns:netconf:base:1.0">
  <create-subscription xmlns="urn:ietf:params:xml:ns:netconf:notification:1.0"/>
</rpc>
]]>]]>
```

The following example shows the reply.

```
<?xml version="1.0" encoding="UTF-8"?>
<rpc-reply message-id="101" xmlns="urn:ietf:params:xml:ns:netconf:base:1.0">
  <ok/>
</rpc-reply>
]]>]]>
```

5.3.1.2 Example of sros-config-change-event notification

The following example shows an sros-config-change-event notification.

```
<notification xmlns="urn:ietf:params:xml:ns:netconf:notification:1.0">
  <eventTime>2017-06-12T09:12:43.376Z</eventTime>
  <sros-config-change-event xmlns="urn:nokia.com:sros:ns:yang:sr:notifications">
    <sequence-number>8447</sequence-number>
    <severity>warning</severity>
    <application>system</application>
    <event-id>2008</event-id>
    <event-name>tmnxConfigDelete</event-name>
    <router-name>Base</router-name>
    <subject>LDP</subject>
    <message>vRtrLdpNgSessionTable: Virtual Router 1, Peer 2.2.2.2:0. managed object
    deleted</message>
    <event-params>
      <tmnxNotifyRow>vRtrLdpNgSessState.1.1.6.2.2.2.0.0</tmnxNotifyRow>
      <tmnxNotifyEntryOID>vRtrLdpNgSessionEntry</tmnxNotifyEntryOID>
      <tmnxNotifyObjectName>vRtrLdpNgSessionTable: Virtual Router 1, Peer 2.2.2.2:0.</
tmnxNotifyObjectName>
    </event-params>
  </sros-config-change-event>
</notification>
```

5.3.1.3 Example of sros-state-change-event notification

The following example shows an sros-state-change-event notification.

```
<notification xmlns="urn:ietf:params:xml:ns:netconf:notification:1.0">
  <eventTime>2017-06-12T09:16:36.781Z</eventTime>
  <sros-state-change-event xmlns="urn:nokia.com:sros:ns:yang:sr:notifications">
    <sequence-number>8460</sequence-number>
    <severity>warning</severity>
    <application>system</application>
    <event-id>2009</event-id>
    <event-name>tmnxStateChange</event-name>
    <router-name>Base</router-name>
    <subject>LDP</subject>
    <message>Status of vRtrLdpNgSessionTable: Virtual Router 1, Peer 2.2.2.2:0. changed
    administrative state: inService, operational state: inService</message>
    <event-params>
      <tmnxNotifyRow>vRtrLdpNgSessState.1.1.6.2.2.2.0.0</tmnxNotifyRow>
      <tmnxNotifyRowAdminState>inService</tmnxNotifyRowAdminState>
    </event-params>
  </sros-state-change-event>
</notification>
```



```

    <tmnxNotifyRowOperState>inService</tmnxNotifyRowOperState>
    <tmnxNotifyEntryOID>vRtrLdpNgSessionEntry</tmnxNotifyEntryOID>
    <tmnxNotifyObjectName>vRtrLdpNgSessionTable: Virtual Router 1, Peer 2.2.2.2:0.</
tmnxNotifyObjectName>
  </event-params>
</sros-state-change-event>
</notification>

```

5.3.1.4 Example of sros-cli-accounting-event notification

The following example shows an sros-cli-accounting-event notification.

```

<notification xmlns="urn:ietf:params:xml:ns:netconf:notification:1.0">
  <eventTime>2017-06-12T09:11:45.476Z</eventTime>
  <sros-command-accounting-event xmlns="urn:nokia.com:sros:ns:yang:sr:notifications">
    <sequence-number>8462</sequence-number>
    <severity>minor</severity>
    <application>user</application>
    <event-id>2011</event-id>
    <event-name>cli_config_io</event-name>
    <router-name>Base</router-name>
    <subject>admin</subject>
    <message>User from CONSOLE: Dut-C>config>log>log-id# /configure router interface "to
DutB_214" </message>
    <event-params>
      <srcAddr>CONSOLE</srcAddr>
      <prompt>Dut-C>config>log>log-id# </prompt>
      <message>/configure router interface "toDutB_214" </message>
    </event-params>
  </sros-command-accounting-event>
</notification>

```

5.3.1.5 Example of sros-log-generic-event notification

The following shows an sros-log-generic-event notification.

```

<notification xmlns="urn:ietf:params:xml:ns:netconf:notification:1.0">
  <eventTime>2017-06-12T09:12:42.344Z</eventTime>
  <sros-log-generic-event xmlns="urn:nokia.com:sros:ns:yang:sr:notifications">
    <sequence-number>8443</sequence-number>
    <severity>warning</severity>
    <application>ospf</application>
    <event-id>2047</event-id>
    <event-name>tmnx0spfNgIfStateChange</event-name>
    <router-name>Base</router-name>
    <subject>VR: 1 OSPFv2 (0) </subject>
    <message>LCL_RTR_ID 1.1.1.1: Interface toDutB_214 state changed to down (event IF_
DOWN)</message>
    <event-params>
      <vRtrID>1</vRtrID>
      <tmnx0spfVersion>version2</tmnx0spfVersion>
      <tmnx0spfInstance>0</tmnx0spfInstance>
      <tmnx0spfRouterId>16843009</tmnx0spfRouterId>
      <tmnx0spfNgIfIndex>0x00000007</tmnx0spfNgIfIndex>
      <tmnx0spfNgIfInstId>0</tmnx0spfNgIfInstId>
      <tmnx0spfNgIfAreaId>0</tmnx0spfNgIfAreaId>
      <tmnx0spfNgIfState>down</tmnx0spfNgIfState>
      <tmnx0spfIfIpAddress>toDutB_214</tmnx0spfIfIpAddress>
    </event-params>
  </sros-log-generic-event>
</notification>

```

```

    <tmnx0spfIfEvent>IF_DOWN</tmnx0spfIfEvent>
    <ospfRouterIdIpAddr>1.1.1.1</ospfRouterIdIpAddr>
  </event-params>
</sros-log-generic-event>
</notification>

```

5.3.1.6 Example of netconf-config-change notification

The following example shows a netconf-config-change notification.

```

<notification xmlns="urn:ietf:params:xml:ns:netconf:notification:1.0"> <eventTime>2016-01-01T19:17:33Z</eventTime>
<netconf-config-change
  xmlns="urn:ietf:params:xml:ns:yang:ietf-netconf-notifications"
  xmlns:notif="urn:nokia.com:sros:ns:yang:sr:notifications"
  xmlns:sros="urn:nokia.com:sros:ns:yang:sr:conf">
  <changed-by>
    <username>user_name</username>
    <session-id>8</session-id>
    <source-host>138.192.72.45</remote-host>
  </changed-by>
  <datastore>running</datastore>
  <edit>
    <target>/config/service/epipe[serviceId=1]</target>
    <operation>create</operation>
    <notif:value>anyValue</notif:value>
  </edit>
</netconf-config-change>
</notification>

```

5.3.1.7 Example of sros-md-rpc-accounting-event notification

The following example shows an sros-md-rpc-accounting-event notification.

```

<?xml version="1.0" encoding="UTF-8"?>
<notification xmlns="urn:ietf:params:xml:ns:netconf:notification:1.0">
  <eventTime>2019-10-08T21:01:50.165Z</eventTime>
  <sros-md-rpc-accounting-event xmlns="urn:nokia.com:sros:ns:yang:sr:notifications">
    <sequence-number>124</sequence-number>
    <severity>minor</severity>
    <application>security</application>
    <event-id>2227</event-id>
    <event-name>netconf_auth</event-name>
    <router-name>management</router-name>
    <subject>admin</subject>
    <message>User admin from 192.168.7.229 port 44559 to port 830 session 7: edit-config
RPC authorized</message>
    <event-params>
      <userName>admin</userName>
      <srcAddr>192.168.7.229</srcAddr>
      <srcPort>44559</srcPort>
      <dstPort>830</dstPort>
      <sessionId>7</sessionId>
      <rpcName>edit-config</rpcName>
    </event-params>
  </sros-md-rpc-accounting-event>
</notification>
]]>]]>

```

5.4 NETCONF monitoring

The `:ietf-netconf-monitoring` capability is advertised in the SR OS NETCONF server `<hello>` using the following syntax.

```
<capability>urn:ietf:params:xml:ns:yang:ietf-netconf-monitoring</capability>
```

The advertised capability provides information about the schemas supported by SR OS, which allows a NETCONF client to query and retrieve schema information from the SR OS NETCONF server.

SR OS supports all subtrees from the YANG model that is used to monitor the NETCONF protocol as described in RFC 6022 (that is, “`:ietf-netconf-monitoring`” capability).

A `<get-schema>` operation is supported for explicit schema retrieval using NETCONF (YANG data model discovery and download as described in RFC 6022). The following parameters are supported:

- **identifier**

This parameter is a mandatory string. It specifies an identifier for the schema list entry (YANG file). It can be the name of a module or a submodule.

- **version**

This parameter is an optional string. It specifies a version of the schema requested (for example, YANG file). It represents the most recent YANG **revision** statement in a module or submodule. There is an empty string if no **revision** statement is present. Because multiple versions may be supported by the NETCONF server, each version must be reported individually in the schema list (it can have same identifier but different versions).

- **format**

This parameter is an optional string. It specifies the data modeling language in which the schema is written. The default value is **yang** when not specified. If specified, **yang** is the only value supported.

Unless the user intentionally specifies a schema path destination to acquire the YANG schema files, the software upgrade process manages the YANG schema files to ensure the schema files are synchronized with the software image on both the primary and standby CPM.

When an SR OS image boots from the primary image, the associated YANG files match the image. If the primary SR OS image fails to boot, and the secondary or tertiary SR OS image loads, the YANG schema files associated with the loaded image are installed and available to the `<get-schema>` NETCONF RPC. The YANG files are delivered with the software image as part of the `yang.tim` file. Nokia recommends that the primary, secondary, and tertiary image strings should not exceed 120 characters each for the `<get-schema>` request to work correctly with all schema files.

Use the following commands to configure the BOF image:

- **MD-CLI**

```
bof image primary-location  
bof image secondary-location  
bof image tertiary-location
```

- **classic CLI**

```
bof primary-image  
bof secondary-image
```

```
bof tertiary-image
```

Use the following command to configure the schema path.

```
configure system management-interface schema-path
```

For the MD-CLI, see *7450 ESS, 7750 SR, 7950 XRS, and VSR MD-CLI Command Reference Guide* for more information about the **schema-path** command.

For the classic CLI, see the *7450 ESS, 7750 SR, 7950 XRS, and VSR Classic CLI Command Reference Guide* for more information about the **schema-path** command.

If this command is configured, all YANG schema files must be manually copied to the specified schema path. The directory structure and path of the schema files must be maintained, so that the <get-schema> RPC is successful.

When the requested schema does not exist, the "invalid-value" <error-tag> is returned. The maximum length of a schema path is 180 characters. However, Nokia recommends that a specified schema path be less than or equal to 135 characters, to guarantee that a <get-schema> works properly with the longest YANG module name in SR OS.

Example: Output of a <get-schema> request

```
<?xml version="1.0" encoding="UTF-8"?>
<rpc message-id="101" xmlns="urn:ietf:params:xml:ns:netconf:base:1.0">
  <get-schema xmlns="urn:ietf:params:xml:ns:yang:ietf-netconf-monitoring">
    <identifier>nokia-conf</identifier>
  </get-schema>
</rpc>
]]>]]>
```

Example: Output of a reply

```
<?xml version="1.0" encoding="UTF-8"?>
<rpc-reply message-id="101" xmlns="urn:ietf:params:xml:ns:netconf:base:1.0">
  <data xmlns="urn:ietf:params:xml:ns:yang:ietf-netconf-monitoring"><![CDATA[module nokia-conf {
    yang-version "1.1";
    namespace "urn:nokia.com:sros:ns:yang:sr:conf";
    ..
  }
]]></data>
</rpc-reply>
```

Use the following command option to synchronize the `yang.tim` file associated with each image between the primary and standby CPM:

- **MD-CLI**

```
admin redundancy synchronize boot-environment
```

- **classic CLI**

```
admin redundancy synchronize boot-env
```

If model-driven management is not enabled on the device and disk space is limited, the `yang.tim` file can be deleted from the flash card. If the file is missing, the system still successfully completes the synchronization, but displays a warning message and reports that it failed to copy the file in the system

logs. Nokia recommends storing the `yang.tim` file with the other software image components on the compact flash.

If the schema path is configured to be a local directory, the preceding command recursively copies all YANG files from the local directory to the standby CPM.

5.4.1 netconf-state schemas

The `schemas` subtree provides a list of the supported YANG schemas on the SR OS device.

The data returned for a query of the `/netconf-state/schemas` path depends on the settings of the various commands in the **yang-modules** container. Examples are available at the end of this section.

A `/netconf-state/schemas` path returns all supported YANG modules.

Example: Output of a request and the received response

```
<?xml version="1.0" encoding="UTF-8"?>
<rpc message-id="101" xmlns="urn:ietf:params:xml:ns:netconf:base:1.0">
  <get>
    <filter>
      <netconf-state xmlns="urn:ietf:params:xml:ns:yang:ietf-netconf-monitoring">
        <schemas/>
      </netconf-state>
    </filter>
  </get>
</rpc>
]]>]]>
```

Example: Output of the reply

```
<?xml version="1.0" encoding="UTF-8"?>
<rpc-reply message-id="101" xmlns="urn:ietf:params:xml:ns:netconf:base:1.0">
  <data>
    <netconf-state xmlns="urn:ietf:params:xml:ns:yang:ietf-netconf-monitoring">
      <schemas>
        <schema>
          <identifier>nokia-conf</identifier>
          <version>2016-07-06</version>
          <format>yang</format>
          <namespace>urn:nokia.com:sros:ns:yang:sr:conf</namespace>
          <location>NETCONF</location>
        </schema>
        <schema>
          <identifier>nokia-conf-aa-group</identifier>
          <version>2018-09-14</version>
          <format>yang</format>
          <namespace>urn:nokia.com:sros:ns:yang:sr:conf</namespace>
          <location>NETCONF</location>
        </schema>
        <schema>
          <identifier>nokia-conf-aaa</identifier>
          <version>2018-08-27</version>
          <format>yang</format>
          <namespace>urn:nokia.com:sros:ns:yang:sr:conf</namespace>
          <location>NETCONF</location>
        </schema>
        ...
        ...
        <schema>

```

```

        <identifier>nokia-state</identifier>
        <version>2016-07-06</version>
        <format>yang</format>
        <namespace>urn:nokia.com:sros:ns:yang:sr:state</namespace>
        <location>NETCONF</location>
    </schema>
    <schema>
        <identifier>nokia-state-aa-group</identifier>
        <version>2018-09-14</version>
        <format>yang</format>
        <namespace>urn:nokia.com:sros:ns:yang:sr:state</namespace>
        <location>NETCONF</location>
    </schema>
    <schema>
        <identifier>nokia-state-aaa</identifier>
        <version>2018-08-27</version>
        <format>yang</format>
        <namespace>urn:nokia.com:sros:ns:yang:sr:state</namespace>
        <location>NETCONF</location>
    </schema>
    ...
    ...
</schemas>
</state>
</data>
</rpc-reply>

```

5.4.2 netconf-state datastores

The datastores subtree provides a list of configuration datastores supported on the SR OS device.

The data returned for a query of the `/netconf-state/datastores` path depends on the settings of the **yang-modules** container and whether NMDA support is configured.

Example: netconf-state datastores request and received response

```

<rpc message-id="50" xmlns="urn:ietf:params:xml:ns:netconf:base:1.0">
  <get>
    <filter>
      <netconf-state xmlns="urn:ietf:params:xml:ns:yang:ietf-netconf-monitoring">
        <datastores/>
      </netconf-state>
    </filter>
  </get>
</rpc>
]]>]]>
<?xml version="1.0" encoding="UTF-8"?>
<rpc-reply message-id="50" xmlns="urn:ietf:params:xml:ns:netconf:base:1.0">
  <data>
    <netconf-state xmlns="urn:ietf:params:xml:ns:yang:ietf-netconf-monitoring">
      <datastores>
        <datastore>
          <name>running</name>
        </datastore>
        <datastore>
          <name>candidate</name>
        </datastore>
        <datastore>
          <name>startup</name>
        </datastore>
        [..SNIP..]
      </datastores>
    </netconf-state>
  </data>
</rpc-reply>

```

```

        </datastore>
      </datastores>
    </netconf-state>
  </data>
</rpc-reply>
]]>]]>

```

5.4.3 netconf-state sessions

The sessions subtree provides a list of all active NETCONF sessions.

Example: netconf-state session request and received response

```

<rpc message-id="50" xmlns="urn:ietf:params:xml:ns:netconf:base:1.0">
  <get>
    <filter>
      <netconf-state xmlns="urn:ietf:params:xml:ns:yang:ietf-netconf-monitoring">
        <sessions/>
      </netconf-state>
    </filter>
  </get>
</rpc>
]]>]]>
<?xml version="1.0" encoding="UTF-8"?>
<rpc-reply message-id="50" xmlns="urn:ietf:params:xml:ns:netconf:base:1.0">
  <data>
    <netconf-state xmlns="urn:ietf:params:xml:ns:yang:ietf-netconf-monitoring">
      <sessions>
        <session>
          <session-id>249</session-id>
          <transport xmlns:ietf-netconf-monitoring=
"urn:ietf:params:xml:ns:yang:ietf-netconf-monitoring">ietf-netconf-monitoring:netconf-
ssh</transport>
          <username>admin</username>
          <source-host>192.168.168.2</source-host>
          <login-time>2022-06-23T13:11:08.0Z</login-time>
          <in-rpcs>1</in-rpcs>
          <in-bad-rpcs>0</in-bad-rpcs>
          <out-rpc-errors>0</out-rpc-errors>
          <out-notifications>0</out-notifications>
        </session>
      </sessions>
    </netconf-state>
  </data>
</rpc-reply>
]]>]]>

```

5.4.4 netconf-state capabilities

The capabilities subtree provides a list of the capabilities of the current NETCONF session. The output is similar to the NETCONF hello message.

5.4.5 netconf-state statistics

The statistics subtree provides statistical data pertaining to the NETCONF service on the SR OS device.

Example: netconf-state statistics request and received response

```

<rpc message-id="50" xmlns="urn:ietf:params:xml:ns:netconf:base:1.0">
  <get>
    <filter>
      <netconf-state xmlns="urn:ietf:params:xml:ns:yang:ietf-netconf-monitoring">
        <statistics/>
      </netconf-state>
    </filter>
  </get>
</rpc>
]]>]]>
<?xml version="1.0" encoding="UTF-8"?>
<rpc-reply message-id="50" xmlns="urn:ietf:params:xml:ns:netconf:base:1.0">
  <data>
    <netconf-state xmlns="urn:ietf:params:xml:ns:yang:ietf-netconf-monitoring">
      <statistics>
        <netconf-start-time>2022-06-22T20:22:21.0Z</netconf-start-time>
        <in-sessions>2</in-sessions>
        <in-rpcs>4</in-rpcs>
        <in-bad-rpcs>1</in-bad-rpcs>
        <out-rpc-errors>1</out-rpc-errors>
        <out-notifications>0</out-notifications>
      </statistics>
    </netconf-state>
  </data>
</rpc-reply>
]]>]]>

```

5.5 YANG library

SR OS supports a mechanism, a YANG library, to identify the YANG modules and submodules that are implemented by the NETCONF server. NETCONF clients should be able to query or cache the YANG library contents and identify whether their cache is out-of-date.

The SR OS NETCONF server supports the "/yang-library" state model and advertises the following capability in the <hello> message (in accordance with RFC 8525):

```

<capability>urn:ietf:params:netconf:capability:yang-
library:1.1?revision=<date>&content-id=<content-id-value></capability>

```

The following is the YANG tree diagram for the "/yang-library" model:

```

module: ietf-yang-library
  +--ro yang-library
    +--ro module-set* [name]
      |   +--ro name                string
      |   +--ro module* [name]
      |     |   +--ro name          yang:yang-identifier
      |     |   +--ro revision?    revision-identifier
      |     |   +--ro namespace    inet:uri
      |     |   +--ro location*    inet:uri
      |     |   +--ro submodule* [name]
      |     |     |   +--ro name      yang:yang-identifier
      |     |     |   +--ro revision? revision-identifier
      |     |     |   +--ro location* inet:uri
      |     |     +--ro feature*    yang:yang-identifier
      |     +--ro deviation*      -> ../../module/name

```



```

|   |--ro import-only-module* [name revision]
|   |--ro name          yang:yang-identifier
|   |--ro revision      union
|   |--ro namespace     inet:uri
|   |--ro location*     inet:uri
|   |--ro submodule* [name]
|   |--ro name          yang:yang-identifier
|   |--ro revision?     revision-identifier
|   |--ro location*     inet:uri
|--ro schema* [name]
| |--ro name            string
| |--ro module-set*    -> ../../module-set/name
|--ro datastore* [name]
| |--ro name            ds:datastore-ref
| |--ro schema          -> ../../schema/name
|--ro content-id       string

```

The SR OS NETCONF server advertises the following capability in the <hello> message:

```

<capability>urn:ietf:params:netconf:capability:yang-
library:1.0?revision=<revision-date>&module-set-id=<string></capability>

```

The following is the YANG tree diagram for the **modules-state** model:

```

|--ro modules-state
| |--ro module-set-id   string
| |--ro module* [name revision]
|   |--ro name          yang:yang-identifier
|   |--ro revision      union
|   |--ro schema?      inet:uri
|   |--ro namespace     inet:uri
|   |--ro feature*     yang:yang-identifier
|   |--ro deviation* [name revision]
|     |--ro name        yang:yang-identifier
|     |--ro revision    union
|   |--ro conformance-type enumeration
|   |--ro submodule* [name revision]
|     |--ro name        yang:yang-identifier
|     |--ro revision    union
|     |--ro schema?     inet:uri

```

The **module-set-id** is a mandatory leaf that identifies a set of YANG modules that the SR OS NETCONF server supports. The value of this leaf changes whenever there is a change in the set of modules or submodules in the YANG library. When this change occurs, SR OS changes the **module-set-id** value advertised in the NETCONF server <hello> message.

The **modules-state** can be used by the NETCONF client to fetch the YANG library, cache it, and re-fetch it only if the value of the **module-set-id** changes again. The YANG library is returned in the **module** list.

Example

If the SR OS NETCONF server advertises the following capability, the NETCONF client can use the advertised **module-set-id** to query the YANG library:

```

<capability>urn:ietf:params:netconf:capability:yang-library:1.0?revision=2018-
05-08&module-set-id=1234</capability>

```

The following example shows the NETCONF client using the advertised **module-set-id** to query the YANG library.

```
<rpc xmlns="urn:ietf:params:xml:ns:netconf:base:1.0" message-id="101">
  <get>
    <filter type="subtree">
      <modules-state xmlns="urn:ietf:params:xml:ns:yang:ietf-yang-library">
        <module-set-id>1234</module-set-id>
          <module>
            </module>
          </modules-state>
        </filter>
      </get>
    </rpc>
  >>>
```

The following example shows the reply.

```
<?xml version="1.0" encoding="UTF-8"?>
<rpc-reply message-id="101" xmlns="urn:ietf:params:xml:ns:netconf:base:1.0">
  <data>
    <modules-state xmlns="urn:ietf:params:xml:ns:yang:ietf-yang-library">
      <module-set-id>1234</module-set-id>
      <module>
        <name>iana-if-type</name>
        <revision>2014-05-08</revision>
        <namespace>urn:ietf:params:xml:ns:yang:iana-if-type</namespace>
        <conformance-type>implement</conformance-type>
      </module>
      ...
      <module>
        <name>nokia-conf</name>
        <revision>2016-07-06</revision>
        <namespace>urn:nokia.com:sros:ns:yang:sr:conf</namespace>
        <conformance-type>implement</conformance-type>
        <submodule>
          <name>nokia-conf-aa-common</name>
          <revision>2018-04-23</revision>
        </submodule>
        ...
      </module>
      ...
    </modules-state>
  </data>
</rpc-reply>
]>>>
```

5.6 Operational commands via NETCONF

Operational commands (for example, **admin reboot**, **file remove**) are supported via NETCONF using:

- individually YANG-modeled operations
- md-cli-raw-command

Nokia recommends using an individually modeled YANG operation, if it is available for a specific operation, instead of the `md-cli-raw-command`. The individually YANG-modeled operations are useful for operations that have specific results data in the output (providing fully modeled and structured output). The `md-cli-raw-command` is available for all SR OS operations but requires string parsing of the output for commands with results data.

Individually modeled operations that are supported over NETCONF can be viewed in the `nokia-oper-*.yang` files in the YANG distribution of a specific software release.

5.6.1 Individually YANG-modeled operations

Some operations are modeled using a YANG "action" statement per operation. These can be viewed in the `nokia-oper-*.yang` files.

The commands in the YANG operations models are invoked via NETCONF using the "action" RPC, as described in section 7.15 of RFC 7950.

For more information, see [YANG-modeled operations](#).

Example: Output of a request to create a new directory on CF1

```
<?xml version="1.0" encoding="UTF-8"?>
<rpc message-id="101" xmlns="urn:ietf:params:xml:ns:netconf:base:1.0">
  <action xmlns="urn:ietf:params:xml:ns:yang:1">
    <file xmlns="urn:nokia.com:sros:ns:yang:sr:oper-file">
      <make-directory>
        <url>cf1:\\my-folder-abc</url>
      </make-directory>
    </file>
  </action>
</rpc>
]]>]]>
```

Example: Output of a reply for a successful directory creation operation

```
<rpc-reply message-id="101" xmlns="urn:ietf:params:xml:ns:netconf:base:1.0"
  xmlns:nokiaoper="urn:nokia.com:sros:ns:yang:sr:oper-file">
  <nokiaoper:operation-id>10</nokiaoper:operation-id>
  <nokiaoper:start-time>2021-06-16T20:09:00.7Z</nokiaoper:start-time>
  <nokiaoper:status>completed</nokiaoper:status>
  <nokiaoper:end-time>2021-06-16T20:09:06.7Z</nokiaoper:end-time>
</rpc-reply>
]]>]]>
```

Example: Output of a CPM synchronize operation request

```
<?xml version="1.0" encoding="UTF-8"?>
<rpc message-id="101" xmlns="urn:ietf:params:xml:ns:netconf:base:1.0">
  <action xmlns="urn:ietf:params:xml:ns:yang:1">
    <admin xmlns="urn:nokia.com:sros:ns:yang:sr:oper-admin">
      <redundancy>
        <synchronize>
          <configuration/>
        </synchronize>
      </redundancy>
    </admin>
  </action>
</rpc>
```

```
]]>]]>
```

Example: Output of a reply when the CPM synchronize operation fails

```
<?xml version="1.0" encoding="UTF-8"?>
<rpc-reply message-id="101" xmlns="urn:ietf:params:xml:ns:netconf:base:1.0">
  <rpc-error>
    <error-type>application</error-type>
    <error-tag>operation-failed</error-tag>
    <error-severity>error</error-severity>
    <error-message>
      MINOR: MGMT_AGENT #2007: Operation failed - secondary CPM offline
    </error-message>
  </rpc-error>
</rpc-reply>
]]>]]>
```

5.6.1.1 <md-compare> YANG-modeled operation

NETCONF can be used to obtain the differences between configurations. The <md-compare> operation is a synchronous YANG modelled operation. See [Individually YANG-modeled operations](#) for more information.

The YANG model with detailed input and output parameters for the <md-compare> operation is available in the YANG distribution for the specific software release.

The following table summarizes a selection of the available input parameters.

Table 30: <md-compare> input parameters

| Input parameter | Description |
|------------------------|---|
| <path>/<subtree-path> | The XML-formatted and correctly namespaced path to the tree location where the <md-compare> operation is executed. Omitting the <subtree-path> executes the <md-compare> operation from the root of the YANG tree. Optional. Default: root (/) |
| <configuration-region> | The SR OS configuration region. See <get> for an example of the <configuration-region>. Optional. Default: configure |
| <format> | The NETCONF output format. See Output format selection for more information. Optional. Default: xml |
| <source> | The source configuration. See Table 31: Source and destination locations for more information. Optional. Default: <candidate/> |

| Input parameter | Description |
|-----------------|---|
| <destination> | The destination configuration. See Table 31: Source and destination locations for more information. Optional. Default: <baseline/> |

The following table describes the source and destination locations available for use.

Table 31: Source and destination locations

| Option | Description |
|-----------------------------------|---|
| <candidate/> | The candidate configuration. This is the default for the <source> input parameter. |
| <baseline/> | The baseline configuration. This is the default for the <destination> input parameter. |
| <url>URL</url> | Uses the location specified in the URL. The following URL types are supported: <ul style="list-style-type: none"> • local (cf1:, cf2:, cf3:, and so on) • non-active CPMs (cf1-b:, cf2-b:, and so on) • remote FTP or TFTP locations |
| <running/> | The running configuration |
| <startup/> | The startup configuration |
| <booted/> | The booted configuration. To use this option, the <configuration-region> must be set to "bof". |
| <rollback-id>NUMBER</rollback-id> | The configuration saved a NUMBER of times ago |
| <commit-id>NUMBER</commit-id> | The configuration at the commit-id identified by NUMBER |

The results from the <md-compare> operation are displayed in the <results>/<md-compare-output> XML field.

The XML-formatted <md-compare> provides the correctly formatted and namespace-aware XML data that, if sent to the node, results in the target configuration. This option is similar to the use of **compare summary netconf-rpc** in the MD-CLI.

The MD-CLI-formatted <md-compare> provides the equivalent output as **compare summary** in the MD-CLI.

The following output shows the example configuration used in the <md-compare> operation examples.

```
<rpc message-id="2" xmlns="urn:ietf:params:xml:ns:netconf:base:1.0" xmlns:yang=
"urn:ietf:params:xml:ns:yang:1">
  <edit-config>
    <target><candidate/></target>
    <config>
      <configure xmlns="urn:nokia.com:sros:ns:yang:sr:conf">
```

```

        <log>
          <log-id>
            <name>50</name>
            <admin-state>enable</admin-state>
            <description>Example</description>
            <source>
              <main>true</main>
              <change>true</change>
            </source>
            <destination>
              <cli>
              </cli>
            </destination>
          </log-id>
        </log>
      </configure>
    </config>
  </edit-config>
</rpc>
]]>]]>
<?xml version="1.0" encoding="UTF-8"?>
<rpc-reply message-id="2" xmlns="urn:ietf:params:xml:ns:netconf:base:1.0" xmlns:yang=
"urn:ietf:params:xml:ns:yang:1">
  <ok/>
</rpc-reply>
]]>]]>

```

See the following sections for examples of the `<md-compare>` operation:

- [<md-compare> using all default values](#)
- [<md-compare> using MD-CLI format](#)
- [<md-compare> using XML format and an explicit path](#)

5.6.1.1.1 <md-compare> using all default values

Example

```

<rpc message-id="121" xmlns="urn:ietf:params:xml:ns:netconf:base:1.0" xmlns:yang=
"urn:ietf:params:xml:ns:yang:1">
  <action xmlns="urn:ietf:params:xml:ns:yang:1">
    <global-operations xmlns="urn:nokia.com:sros:ns:yang:sr:oper-global">
      <md-compare/>
    </global-operations>
  </action>
</rpc>
]]>]]>
<?xml version="1.0" encoding="UTF-8"?>
<rpc-reply message-id="121" xmlns="urn:ietf:params:xml:ns:netconf:base:1.0" xmlns:yang=
"urn:ietf:params:xml:ns:yang:1" xmlns:nokiaoper="urn:nokia.com:sros:ns:yang:sr:oper-
global">
  <nokiaoper:operation-id>11</nokiaoper:operation-id>
  <nokiaoper:start-time>2022-06-20T22:03:09.9Z</nokiaoper:start-time>
  <nokiaoper:results>
    <nokiaoper:md-compare-output>
      <configure xmlns="urn:nokia.com:sros:ns:yang:sr:conf" xmlns:nokia-attr=
"urn:nokia.com:sros:ns:yang:sr:attributes">
        <log>
          <log-id>
            <name>50</name>
            <admin-state>enable</admin-state>

```

```

        <description>Example</description>
        <source>
            <main>true</main>
            <change>true</change>
        </source>
        <destination>
            <cli>
            </cli>
        </destination>
    </log-id>
</log>
</configure>
</nokiaoper:md-compare-output>
</nokiaoper:results>
<nokiaoper:status>completed</nokiaoper:status>
<nokiaoper:end-time>2022-06-20T22:03:10.0Z</nokiaoper:end-time>
</rpc-reply>
]]>]]>

```

5.6.1.1.2 <md-compare> using MD-CLI format

Example

```

<rpc message-id="121" xmlns="urn:ietf:params:xml:ns:netconf:base:1.0" xmlns:yang=
"urn:ietf:params:xml:ns:yang:1">
  <action xmlns="urn:ietf:params:xml:ns:yang:1">
    <global-operations xmlns="urn:nokia.com:sros:ns:yang:sr:oper-global">
      <md-compare>
        <format>md-cli</format>
      </md-compare>
    </global-operations>
  </action>
</rpc>
]]>]]>
<?xml version="1.0" encoding="UTF-8"?>
<rpc-reply message-id="121" xmlns="urn:ietf:params:xml:ns:netconf:base:1.0" xmlns:yang=
"urn:ietf:params:xml:ns:yang:1" xmlns:nokiaoper="urn:nokia.com:sros:ns:yang:sr:oper-
global">
  <nokiaoper:operation-id>12</nokiaoper:operation-id>
  <nokiaoper:start-time>2022-06-20T22:09:24.6Z</nokiaoper:start-time>
  <nokiaoper:results>
    <nokiaoper:md-compare-output>
      configure {
        log {
+         log-id "50" {
+           admin-state enable
+           description "Example"
+           source {
+             main true
+             change true
+           }
+           destination {
+             cli {
+             }
+           }
+         }
+       }
    </nokiaoper:md-compare-output>
  </nokiaoper:results>
  <nokiaoper:status>completed</nokiaoper:status>

```

```
<nokiaoper:end-time>2022-06-20T22:09:24.6Z</nokiaoper:end-time>
</rpc-reply>
]]>]]>
```

5.6.1.1.3 <md-compare> using XML format and an explicit path

The following example shows the <md-compare> operation run from the **configure log log-id 50 source** path specifying explicitly the XML format.

Example

```
<rpc message-id="121" xmlns="urn:ietf:params:xml:ns:netconf:base:1.0" xmlns:yang=
"urn:ietf:params:xml:ns:yang:1">
  <action xmlns="urn:ietf:params:xml:ns:yang:1">
    <global-operations xmlns="urn:nokia.com:sros:ns:yang:sr:oper-global">
      <md-compare>
        <format>xml</format>
        <path>
          <subtree-path>
            <configure xmlns="urn:nokia.com:sros:ns:yang:sr:conf">
              <log>
                <log-id>
                  <name>50</name>
                  <source/>
                </log-id>
              </log>
            </configure>
          </subtree-path>
        </path>
      </md-compare>
    </global-operations>
  </action>
</rpc>
]]>]]>
<?xml version="1.0" encoding="UTF-8"?>
<rpc-reply message-id="121" xmlns="urn:ietf:params:xml:ns:netconf:base:1.0" xmlns:yang=
"urn:ietf:params:xml:ns:yang:1" xmlns:nokiaoper="urn:nokia.com:sros:ns:yang:sr:oper-
global">
  <nokiaoper:operation-id>14</nokiaoper:operation-id>
  <nokiaoper:start-time>2022-06-20T22:12:18.6Z</nokiaoper:start-time>
  <nokiaoper:results>
    <nokiaoper:md-compare-output>
      <configure xmlns="urn:nokia.com:sros:ns:yang:sr:conf" xmlns:nokia-attr=
"urn:nokia.com:sros:ns:yang:sr:attributes">
        <log>
          <log-id>
            <name>50</name>
            <source>
              <main>true</main>
              <change>true</change>
            </source>
          </log-id>
        </log>
      </configure>
    </nokiaoper:md-compare-output>
  </nokiaoper:results>
  <nokiaoper:status>completed</nokiaoper:status>
  <nokiaoper:end-time>2022-06-20T22:12:18.6Z</nokiaoper:end-time>
</rpc-reply>
]]>]]>
```

5.6.1.2 <pyexec> YANG-modeled operation

The pySROS libraries enable Python 3 applications that connect to the SR OS node to perform operations, obtain state data, or make configuration changes. These applications run on the originating system's Python interpreter.

Use the MD-CLI **pyexec** command to execute a Python 3 application with the pySROS libraries using the MicroPython interpreter on the SR OS node.

The **<pyexec>** YANG-modeled operation allows NETCONF clients (both management systems and code) to remotely trigger the execution of a Python application to run on the MicroPython interpreter of the SR OS node.

The **pyexec** MD-CLI command and the **<pyexec>** YANG-modeled operation both accept up to ten command line arguments.

The following table summarizes the available input parameters.

Table 32: <pyexec> input parameters

| Input parameter | Description |
|-----------------|--|
| url | The URL that the Python application is located at. If no specific URL is provided in the input, the system default of cf3:\ is prepended to the URL value. Mandatory. |
| argument-01 | The first command line argument to the Python application. Optional. |
| argument-02 | The second command line argument to the Python application. Optional. |
| argument-03 | The third command line argument to the Python application. Optional. |
| argument-04 | The fourth command line argument to the Python application. Optional. |
| argument-05 | The fifth command line argument to the Python application. Optional. |
| argument-06 | The sixth command line argument to the Python application. Optional. |

| Input parameter | Description |
|-----------------|---|
| argument-07 | The seventh command line argument to the Python application. Optional. |
| argument-08 | The eighth command line argument to the Python application. Optional. |
| argument-09 | The ninth command line argument to the Python application. Optional. |
| argument-10 | The tenth command line argument to the Python application. Optional. |



Note: The NETCONF server errors if an argument is omitted, for example, argument-01 and argument-03 are provided but argument-02 is not.

Consider the following simple Python application saved as cf3:\example.py on the SR OS device.

Example: Python application saved on an SR OS device

```

from pysros.management import connect
import sys

def main():
    try:
        connection_object = connect()
    except Exception as error:
        raise SystemError(error) from error
    print("pySR0S application running on host:", connection_object.running.get('/nokia-
conf:configure/system/name'))
    print("Arguments:", sys.argv[1::])

main()

```

When executed on the SR OS node using the **pyexec** MD-CLI command, the system displays the following output.

Output example

```

[/]
A:admin@node-2# pyexec example.py ex1 ex2 ex3 ex4 ex5 ex6 ex7 ex8 ex9 ex10
pySR0S application running on host: sros-router1
Arguments: ['ex1', 'ex2', 'ex3', 'ex4', 'ex5', 'ex6', 'ex7', 'ex8', 'ex9', 'ex10']

```

On a remote NETCONF client, sending the **<pyexec>** YANG-modeled operation executes the example.py Python application stored on the node using the node's MicroPython interpreter.

Output example

```
<rpc message-id="example" xmlns="urn:ietf:params:xml:ns:netconf:base:1.0">
```

```

<action xmlns="urn:ietf:params:xml:ns:yang:1">
  <global-operations xmlns="urn:nokia.com:sros:ns:yang:sr:oper-global">
    <pyexec>
      <url>example.py</url>
      <argument-01>test1</argument-01>
      <argument-02>test2</argument-02>
      <argument-03>test3</argument-03>
      <argument-04>test4</argument-04>
      <argument-05>test5</argument-05>
      <argument-06>test6</argument-06>
      <argument-07>test7</argument-07>
      <argument-08>test8</argument-08>
      <argument-09>test9</argument-09>
      <argument-10>test10</argument-10>
    </pyexec>
  </global-operations>
</action>
</rpc>
]]>]]>

```

The system returns the following response. The bolded section is the same output as that shown on the MD-CLI output with the arguments provided in the NETCONF request entered and returned to the **pyexec** output. This output is encapsulated in the `<pyexec-output-block>` field of the modeled NETCONF response.

Output example

```

<rpc-reply xmlns="urn:ietf:params:xml:ns:netconf:base:1.0" message-id="example"
  xmlns:nokiaoper="urn:nokia.com:sros:ns:yang:sr:oper-global">
  <nokiaoper:operation-id>20</nokiaoper:operation-id>
  <nokiaoper:start-time>2023-08-23T19:50:43.7Z</nokiaoper:start-time>
  <nokiaoper:results>
    <nokiaoper:pyexec-output-block>pySR0S application running on host: sros-router1
Arguments: ['test1', 'test2', 'test3', 'test4', 'test5', 'test6', 'test7', 'test8',
'test9', 'test10']
  </nokiaoper:pyexec-output-block>
  </nokiaoper:results>
  <nokiaoper:status>completed</nokiaoper:status>
  <nokiaoper:end-time>2023-08-23T19:50:44.0Z</nokiaoper:end-time>
</rpc-reply>
]]>]]>

```

5.6.2 NETCONF operations using the md-cli-raw-command request

In addition to individually YANG-modelled operations described in [Individually YANG-modeled operations](#), SR OS also supports a wide set of operations over NETCONF with the md-cli-raw-command request.

Nokia recommends using an individually modeled YANG operation if it is available for a specific operation, but for operations that are not individually YANG-modelled, the md-cli-raw-command can be used.

The command input string accepts a command in the exact format as it would be entered in the MD-CLI. For example:

```

<rpc message-id="101" xmlns="urn:ietf:params:xml:ns:netconf:base:1.0">
  <action xmlns="urn:ietf:params:xml:ns:yang:1">
    <global-operations xmlns="urn:nokia.com:sros:ns:yang:sr:oper-global">
      <md-cli-raw-command>
        <md-cli-input-line>clear router Base interface system statistics</md-cli-input-line>
      </md-cli-raw-command>
    </global-operations>
  </action>
</rpc>
]]>]]>

```

```
</global-operations>
</action>
</rpc>
```

Other examples of commands that can be used as input strings include:

- file list cf1:
- show system information
- tools dump resource-usage
- tools perform cflowd manual-export
- //debug router ldp interface foo

The SR OS NETCONF server workflow to process the md-cli-raw-command request is the following.

1. Open a new temporary MD-CLI session (with the same username as the NETCONF session).
2. Pass the input command to the MD-CLI engine.
3. Return the MD-CLI output to the NETCONF client as an unstructured block of text in the <rpc-reply> message.

The MD-CLI context for the operation is the root and the MD-CLI executes the command in operational mode, which is similar to a user newly logged into an MD-CLI session.

Interactive commands, or commands that prompt for input, are not supported and result in an error. For example, using "admin reboot" as an input string fails. Using "admin reboot now" is accepted. Other examples of interactive commands that are not supported include:

- enable
- password
- ssh
- telnet

The **cli-engine** command controls the engines allowed to process the input. Because the starting context for any md-cli-raw-command is the root of the MD-CLI engine, any configuration value that does not allow **md-cli** access causes md-cli-raw-command requests to fail. Access to classic CLI commands through the md-cli-raw-command (for example, commands starting with "//") requires access to both **md-cli** and **classic-cli**. Changes to the **cli-engine** configuration only take effect on raw-md-cli-command in NETCONF sessions that are started after the **cli-engine** configuration was changed.

Only a single operation is supported as the input to the md-cli-raw-command request. Multiple operations require multiple NETCONF RPCs.

The md-cli-raw-command request is not intended as a mechanism to read structured state data or to manage basic configuration. The YANG-modeled configuration and state data is managed and accessed using standard NETCONF operations, such as <edit-config>, <get-config>, and <get>.

The following MD-CLI commands and similar commands are not supported as input strings for md-cli-raw-command:

- admin show configuration
- bof
- configure
- debug
- edit-config

- environment
- exec
- file edit
- history
- info
- li
- logout
- pyexec (when invoked from the pySR0S Python 3 libraries)
- //admin display-config
- //admin compare
- //admin rollback
- //admin view
- //bof
- //candidate
- //configure
- //environment
- //exec
- //file vi
- //history
- //logout

Unstructured state information can be retrieved using md-cli-raw-command, for example, with **show** or **tools** dump commands as the input string. The output returned, however, is an unstructured block of text. Structured state information can be retrieved using the standard NETCONF <get> operation.

6 Python

6.1 Python overview

Python is an established programming language that is widely used in systems administration. It has become one of the most prominent languages for network automation.

Python is popular because of its extensive libraries that software developers can import and enhance, and because it offers programming simplicity without diluting the flexibility and scalability offered by other languages.



Note: This chapter assumes prior knowledge and experience with the Python programming language.

6.2 Python in SR OS

SR OS uses version 2 and version 3 of the Python language.

Python 2 and Python 3 are available for ESM applications. Syslog supports Python 2 only. For more information, see [Customizing syslog messages using Python](#) and the *7450 ESS, 7750 SR, and VSR Triple Play Service Delivery Architecture Guide, "Python script support for ESM"*.

Python 3 is available for Python applications run in the MD-CLI using the **pyexec** or **alias** commands, and for applications executed remotely. Python 2 is not supported for **pyexec**, **alias**, CRON, or EHS in the MD-CLI.

The remainder of this section references the SR OS Python 3 functionality only.

6.2.1 Prerequisites

The SR OS node must be in model-driven management interface configuration mode to run Python 3 applications.

To execute Python 3 applications on a remote device that connects to an SR OS device, the following prerequisites must be met:

- On the SR OS node, the NETCONF protocol must be enabled.
- The user must have the required permissions to use the NETCONF protocol.
- On the remote device (that is, the device that executes the application), a Python 3 interpreter of version 3.10 or newer is required.

6.2.2 YANG model support

The Python 3 and pySROS features support Nokia YANG modules (combined and split) and OpenConfig YANG modules. If the YANG modules are to be obtained from the SR OS device, the YANG module files must be available at the specified schema path. See [NETCONF monitoring](#) for more information.

6.3 Python 3 interpreter

The Python interpreter is software that compiles and runs applications that developers create. It also handles importing additional libraries and all syntax for the language itself.

SR OS provides the MicroPython interpreter on the SR OS node. This interpreter implements Python 3.4 and is designed to operate using a small memory footprint, which allows SR OS to launch multiple interpreters in parallel.

The Python 3 interpreter is called by the SR OS function that requires it; for example, the MD-CLI. The interpreter is not called directly by the operator.

6.4 Building an application

Customized applications can be written to run on an SR OS node or remotely.

Developers can create applications using any development environment, including a Python 3-based Integrated Development Environment (IDE) or a text editor.

Python 3 applications written for SR OS are designed to be portable between systems (SR OS and operator devices), provided the libraries and language features used are available on both systems.

6.4.1 Available libraries

The following table describes the available preinstalled Python libraries that SR OS provides.



Note: Libraries prefixed by the letter “u” are MicroPython-specific libraries. Importing to a script using the base name is typically possible; for example, `import json` imports `ujson` when running on an SR OS device.

Table 33: Available libraries

| Library | Description |
|-----------|---|
| binutils | Collection of binary utilities |
| datetime | Manipulation of various formats for date, time, and time zone. The strptime function is not supported. |
| ubinascii | Bidirectional translation between binary data and various ASCII encodings |
| ujson | Conversion between Python objects and JSON data format |

| Library | Description |
|--------------|--|
| pysros | Model-driven management API for SR OS (Python for the Service Router Operating System – pySR0S) |
| ucollections | Advanced collection and container types to hold or accumulate various objects |
| ure | Simple regular expressions |
| sys | System-specific parameters and functions |
| uhashlib | Binary data hashing algorithms |
| ustruct | Pack and unpack primitive data types |
| ipaddress | IPv4 and IPv6 address manipulation |
| uio | Input and output streams |
| utime | Obtain current date and time, measuring intervals, and delays. This function has been updated to provide support for SR OS and is documented in the API documentation. |

6.4.2 The pySROS API

Python for the Service Router Operating System (pySROS) libraries provide the programmatic interface to the SR OS model-driven management framework.

The libraries provide a set of methods for developers to obtain, manipulate, and deliver data to and from an SR OS node.



Note: Nokia recommends reviewing the API documentation provided with the pySROS libraries before developing any Python applications.

6.4.2.1 Installing the pySROS libraries

The pySROS libraries are delivered and preinstalled on SR OS nodes. This libraries can be installed on another device, such as a PC or UNIX workstation.



Note: A Python 3 interpreter must be already installed on the device.

Use one of the following methods to install the pySROS libraries:

1. from the Python Package Index (PyPI) using the pip tool (preferred method)

To do this, execute the **pip install pysros** command on the device.

2. from source code delivered from github.com

To do this, clone the source code repository to your device by executing the **git clone https://github.com/nokia/pysros** command.

The source code can then be compiled and installed by executing **python3 setup.py install**.

3. from source code delivered from the Nokia online support portal

To do this, obtain the source code from the Nokia online support portal. This is the same location where the SR OS software resides.

The source code can then be compiled and installed by executing **python3 setup.py install**.

6.4.2.2 Importing into applications

The pySROS libraries must be imported to use the provided API in developed applications.

The libraries may be imported using the **import pysros** command, or only specific elements of the API may be imported; for example, from **pysros.management import connect**.

6.4.2.3 API documentation

This chapter provides a high-level overview about how to connect to the model-driven interfaces of an SR OS device and manipulate simple data structures. Detailed technical documentation for the pySROS API is provided within the source code bundle in the docs directory.

The API documentation is provided as source code and should be built as needed. To compile the API documentation, run the following commands from the docs directory:

- **pip install -r requirements.txt**
- **make html**

The API documentation is compiled into the build/html folder in HTML format.



Note: Nokia recommends reviewing the API documentation provided with the pySROS libraries before developing any Python applications.

6.4.2.4 Connecting to a model-driven SR OS device

To enable access to an SR OS device, the user must create a Connection object, which is a Python object that references the application's connection to a specific SR OS node.

The underlying connection transport protocol is NETCONF.

The connect() API method is provided to create this Connection object.

The following example shows the creation of a connection named `connection_object` to a device with the IP address 192.168.168.1.

```
from pysros.management import connect
connection_object = connect(host='192.168.168.1', username='admin', password='admin')
```

The following table describes the arguments available for the connect() API method.



Note: All arguments are ignored when the Python application is executed on an SR OS device.

Table 34: The connect() API method arguments

| Argument | Type | Mandatory | Description |
|----------------|---------|-----------|---|
| host | string | Yes | IP address, hostname, or FQDN of the SR OS device to connect to |
| username | string | Yes | Username to connect to the SR OS device |
| password | string | Yes | Password to connect to the SR OS device If no password is provided, SSH key-based authentication is attempted. |
| port | integer | No | TCP port on the SR OS node that the connect attempt is made to Default: 830 |
| yang_directory | string | No | Directory to read YANG module files from Default: None |
| rebuild | Boolean | No | Forces the schema cache to be rebuilt upon connect Default: False |
| timeout | integer | No | Maximum time for connection, obtaining YANG modules, and schema generation Default: 300 seconds |
| hostkey_verify | Boolean | No | Disables SSH hostkey checking. Nokia recommends to not use this in a live deployment. |

When a Python application makes a connection to an SR OS device using the connect() method, the application performs the following actions.

- The device is queried to identify a set of modules required to manage the device. This is performed by identifying the module-set-id (yang-library:1.0) or content-id (yang-library:1.1) from the devices advertised capabilities.
- The set of modules are queried using /modules-state from the IETF YANG library RFC 8525.
- The local schema cache is checked to determine whether a model-driven management schema is already generated for the same set of YANG modules. If no identical local schema cache exists, or if the rebuild argument is set to True, the following occurs.
 - If the yang_directory argument is not provided to the connect() API method, each YANG module listed by the SR OS node is downloaded directly from the node.
 - If the yang_directory argument is provided to the connect() API method, the YANG module files from this directory that correspond to the list of required modules obtained from the router are used.

- The YANG modules are compiled into a schema cache for use by the developer and the pySROS libraries.



Note: The connect() API method is slower to complete for the first compilation of a specific set of YANG modules. Subsequent connections for that set of YANG modules are significantly faster. A locally cached set of YANG modules is not specific to an individual router.

The local model-driven schema cache is stored in the `.pysros` directory within the developer's local home directory. If this directory is deleted or modified, the cache is rebuilt on the next connect() API call.

6.4.2.5 Obtaining modeled data

Use the get() API method to obtain modeled data from an SR OS device.

The get() API method accepts as inputs a JSON instance identifier path and a datastore. The method returns a Python data structure, which uses the pySROS format to provide modeled data to the developer. See [The pySROS data structure](#) for more information.

A JSON instance path is obtained from an SR OS node using the **pwc json-instance-path** command. See the *7450 ESS, 7750 SR, 7950 XRS, and VSR MD-CLI User Guide* for more information.

The following example obtains data from an SR OS node Connection object.

```
my_data = connection_object.running.get('/nokia-state:state/system/oper-name')
```



Note: State information is obtained from the running the datastore when using the pySROS libraries.

6.4.2.6 Performing operations with pySROS

In addition to device configuration and state information collection, operators can perform the following types of node operations:

- a YANG-modeled operation (defined as an 'action' in a YANG model), which uses structured data for both input and output
- an MD-CLI command, which provides semi-structured input and unstructured output

Nokia recommends using the action() API method when performing operations with SR OS. Some cases may require using an unmodeled MD-CLI command, which can be performed using the cli() API method and manipulating the resulting string output.

6.4.2.6.1 YANG-modeled operations with pySROS

The action() API method allows developers to pass YANG-modeled, structured-data inputs to an operation to be executed on the router and to receive YANG-modeled, structured-data output.

The following example shows a ping operation from the pySROS API.

```
>>> connection_object.action('/nokia-oper-global:global-operations/ping', {'destination':
'192.168.122.1'})

Action({'operation-id': Leaf(13), 'start-time': Leaf('2023-10-04T19:00:20.1Z'), 'results':
Container({'test-parameters': Container({'destination': Leaf('192.168.122.1'), 'bypass-
```

```
routing': Leaf(False), 'router-instance': Leaf('Base'), 'srv6-policy': Leaf(False), 'candidate-
path': Leaf(False), 'preference': Leaf(100), 'count': Leaf(5), 'output-format': Leaf('detail'),
'do-not-fragment': Leaf(False), 'fc': Leaf('nc'), 'interval': Leaf('1'), 'pattern':
Leaf('sequential'), 'size': Leaf(56), 'timeout': Leaf(5), 'tos': Leaf(0), 'ttl': Leaf(64)),
'probe': {1: Container({'probe-index': Leaf(1), 'status': Leaf('no-route-to-dest')}), 2:
Container({'probe-index': Leaf(2), 'status': Leaf('no-route-to-dest')}), 3: Container({'probe-
index': Leaf(3), 'status': Leaf('no-route-to-dest')}), 4: Container({'probe-index': Leaf(4),
'status': Leaf('no-route-to-dest')}), 5: Container({'probe-index': Leaf(5), 'status':
Leaf('no-route-to-dest')})), 'summary': Container({'statistics': Container({'packets':
Container({'sent': Leaf(5), 'received': Leaf(0), 'loss': Leaf('100.0')}), 'round-trip-time':
Container({'minimum': Leaf(0), 'average': Leaf(0), 'maximum': Leaf(0)}))})), 'status':
Leaf('completed'), 'end-time': Leaf('2023-10-04T19:00:24.3Z')})
```

6.4.2.6.2 MD-CLI command execution with pySROS

The `cli()` API method allows developers to pass a single line string containing a single MD-CLI command (including output modifiers, if required) to an existing SR OS connection object. SR OS executes this command immediately and returns the output as a string. See [NETCONF operations using the md-cli-raw-command request](#) for more information about supported commands.

The following example executes an MD-CLI command from the pySROS API.

```
output_string = connection_object.cli('show system time')
print(output_string)
=====
Date & Time
=====
Current Date & Time : 2021/09/15 20:27:27      DST Active          : no
Current Zone       : UTC                    Offset from UTC     : 00:00
-----
Non-DST Zone      : UTC                    Offset from UTC     : 00:00
Zone type         : standard
-----
No DST zone configured.
-----
Prefer Local Time : NO
=====
```

6.4.2.7 Editing configuration

Python data structures, in pySROS format, and specific values within the data structures can be configured on an SR OS device.

The `set()` API method is provided to configure a node. The `set()` API method aggregates several model-driven transactional operations into a single method:

- configuration of the node (performed in private candidate configuration mode)
- update, validate, and commit

The `set()` API method accepts as input a JSON instance path, a datastore, and a payload. The payload may be a single value, a key and value pair, a crafted Python data structure following the pySROS data-structure format, or a pySROS data structure object received from a `get()` API method call.

The following examples show how to set the system name to "hostname".

```
connection_object.candidate.set("/nokia-conf:configure/system/name", "hostname")
connection_object.candidate.set("/nokia-conf:configure/system", {'name': 'hostname'})
```

```
connection_object.candidate.set("/nokia-
conf:configure", {'system': {'name': 'hostname'}})
```

6.4.3 The pySROS data structure

The key to efficient Python programs for network management is the ability to manipulate data in a consumable format.

The pySROS libraries ensure that the YANG modeled data from SR OS is supplied in native Python data structures that are simple to understand and handle in code.

When data is obtained from an SR OS node, it is returned in a specific data structure format, a pySROS data structure.

The following table shows the pySROS conversion from model-driven YANG-based data structures to native Python data structures.

Table 35: Model-driven to Python data structure conversion rules

| YANG structure | Python 3 structure |
|-------------------|---|
| Container | Dict |
| Leaf | Value (Type derived as shown in The pySROS data structure) |
| Leaf-list | List |
| List | Dict |
| User-ordered List | OrderedDict keyed on the YANG list key value |

The pySROS libraries provide Python class wrappers around each node type to assist with data manipulation. This information can be used with some of the features built into the pySROS API, such as pretty-printing.

Containers are wrapped in a Container() class.

Leafs are wrapped in a Leaf() class.

Example: Command usage to obtain the value of a leaf

The following example shows how to obtain the value of the leaf that is wrapped in a Leaf() class by calling the .data function on the leaf.

```
from pysros.wrappers import Leaf
obj = Leaf('example')
print(obj.data)
```

Leaf-lists are wrapped in a LeafList() class.

All pySROS class wrappers for YANG nodes are provided by **pysros.wrappers**.

YANG schema metadata can be obtained on a specific data object by calling the schema function. The YANG metadata that is available within the pySROS data structure (data is the specific pySROS formatted data object) is the data.schema.module. This is the YANG module name the element comes from. If this element in the YANG schema is imported or included from another YANG modules, the root YANG module

is displayed. If the YANG modules where the element is found is an augment to another module, the augment module is shown.

YANG types are also converted into native Python types. The following table describes the rules for this conversion.

Table 36: YANG types

| Base YANG type | Python 3 type |
|----------------|---------------------------------|
| binary | String |
| bits | String |
| boolean | Boolean |
| decimal64 | String |
| empty | 11 |
| enumeration | String |
| identityref | String |
| int8 | Integer |
| int16 | Integer |
| int32 | Integer |
| int64 | Integer |
| leafref | (not applicable ¹²) |
| string | String |
| uint8 | Integer |
| uint16 | Integer |
| uint32 | Integer |
| uint64 | Integer |
| union | String ¹³ |

¹¹ The specific type is provided by the pySR0S libraries.

¹² A leafref takes the YANG native type of the leaf it is referencing. This type is converted to Python according to the table.

¹³ A union YANG type may be a union of different YANG types, for example, a union of a string and a Boolean. As it is not possible to identify the intention at the time of obtaining the data, automatic type selection is not performed. Every union is treated as a string, allowing the developer to cast the element into a specified type.

6.5 Provisioning and precompiling Python applications

Python applications can be configured and executed in the MD-CLI. This allows administrators to provide specific Python applications to users.

Python applications can be referenced in configuration statements, such as MD-CLI aliases.

Python applications are configured in the **configure python** context. The following is a Python application configuration example.

Example

```
(ex)[/configure python]
A:admin@node-2# info
  python-script "my_example" {
    admin-state enable
    urls ["cf3:\example.py" "ftp://user:password@192.168.254/example.py"]
    version python3
  }
```

After a Python application is configured and committed, the SR OS node attempts to load the files specified in the `urls` field in the order they are listed. If the first URL location can be reached and a file containing valid Python code is found, the system stores this source code ready for use.

If the first URL cannot be reached or the file does not contain valid source code, the system moves to the next URL in the list. If no URL locations contain valid Python source code, the **oper-state** leaf for the configured application is set to down in the following context.

```
state python python-script application_name
```

6.5.1 Refreshing configured python scripts

When defined in the SR OS configuration, Python scripts are stored in memory on the SR OS node. The URLs defined in the configuration are not rechecked, unless it is specifically requested by an operator.

If a new version of the script is placed in the URL reference location, whether locally on the SR OS nodes storage card or remotely, the **tools perform python-script reload *application_name*** command must be run to use the new version.

6.6 Execution pathways

This section describes the methods that are provided to execute Python applications.

6.6.1 Executing a Python application remotely

The pySROS libraries provide the ability to interface with one or more SR OS devices from a device that has a Python interpreter installed. This execution pathway is not specific to SR OS (beyond the use of the pySROS libraries) and is not described further in this guide.

6.6.2 Executing a Python application from the command line

The MD-CLI provides the ability to execute a Python application directly from the command line.

The **pyexec** command takes as an option, either the name of a Python application from the SR OS configuration (**configure python python-script *application_name***) or the URL to the location (local/remote) of a Python application.

For example, if the **pyexec *application_name*** command is executed, the SR OS performs the following steps.

1. The SR OS device searches for a configuration element **configure python python-script *application_name***. If a configuration element is found, the system attempts to compile and execute this script. A failure ends the execution.
2. The SR OS device treats the *application_name* as a URL. As *application_name* does not have a URL identifier (such as `cf3:\` or `ftp://`) attached to it, SR OS prepends the present working directory of the system (which is `cf3:\` by default on most systems).
3. SR OS attempts to read from the derived URL; for example, `cf3:\application_name`. If this URL is successfully located, SR OS compiles and runs the application. A failure ends the execution.

Each time **pyexec** is invoked, a new Python interpreter is spawned.

6.6.2.1 pyexec and input parameters

The **pyexec** command can accept a maximum of ten input arguments provided using the MD-CLI command line. The Python application developer must handle these as standard input (STDIN) arguments.

6.6.2.2 Executing a Python application as an output modifier

Python applications can be entered as an output modifier to the MD-CLI commands.

The following is an example output from an **info** command that is processed by a Python application, which capitalizes the output.

Example

```
(ex)[/]
A:admin@node-2# file show cf3:\capitals.py
File: capitals.py
-----
import sys
def main():
    for line in sys.stdin:
        print(line.upper(), end="")
main()
=====
(ex)[/]
A:admin@node-2# show version | pyexec capitals.py
TIMOS-B-21.7.B1-9 BOTH/X86_64 NOKIA 7750 SR COPYRIGHT (C) 2000-2021 NOKIA.
ALL RIGHTS RESERVED. ALL USE SUBJECT TO APPLICABLE LICENSE AGREEMENTS.
BUILT ON THU JUN 12 18:35:55 PDT 2021 BY BUILDER IN /BUILDS/C/217B/B1-9/PANOS/MAIN/SROS
```

6.6.2.3 Chaining Python applications

The **pyexec** command supports chaining multiple applications on the command line. Python applications called with the **pyexec** command can produce data on the standard output (STDOUT) stream and consume data on the standard input (STDIN) stream. Multiple Python applications can then be chained together.



Note: A maximum of three **pyexec** commands may be chained together.

6.6.2.4 Python applications and the MD-CLI pager

Python applications executed using the **pyexec** command use the built-in MD-CLI pager to display the output one page at a time. This behavior can be disabled per Python application using the **no-more** output modifier, or globally by setting the MD-CLI **environment more** option to **false**, as required.

When the MD-CLI display output is paused by the pager while executing a Python application, pressing **q** closes the pager and resumes executing the Python application. Pressing **Ctrl-c** closes the pager and terminates the Python application.

6.6.3 Executing Python applications with MD-CLI command aliases

Python applications can be executed from a configured alias in MD-CLI. See "Command Aliases" in the *7450 ESS, 7750 SR, 7950 XRS, and VSR MD-CLI User Guide* for more information about how to configure an alias in the MD-CLI.

Aliases may call a configured (named) Python application or the **pyexec** command.

There are specific AAA considerations for each method. See [Authentication, authorization, and accounting](#) for more information.

Each time an alias that references a Python application is executed, a new Python interpreter is spawned.

6.7 Security

6.7.1 Python authentication and authorization

Python applications are dependent on authentication, authorization, and accounting in the same way as any other feature of SR OS. See [Authentication, authorization, and accounting](#) for more information.

The user associated with the current session is used for authentication, authorization, and accounting of the script, as well as the authorization of the content of the scripts results, and any resulting file access.

If the **configure python python-script run-as-user** command is configured, the specified user is used for all authentication, authorization, accounting, and file access of the script, instead of the current session user.

The **run-as-user** command is configured on a per python-script basis and takes precedence over any other user configured on a less granular level (for example, CRON or EHS).



Note: If the **run-as-user** command is specified, Nokia recommends paying particular attention to the authorization rules about who is allowed to execute the configured **python-script**.

6.7.1.1 Authentication

To make a connection to the model-driven interface of an SR OS device, user authentication is required.

User authentication is deemed to have already occurred if the Python application is executed directly on the SR OS node.

If the Python application is executed remotely, user credentials must be provided to the `connect()` API call.

6.7.1.2 Authorization

To successfully use a Python application, the authenticated user must have authorization to both execute the application and perform each of the model-driven operations contained within the Python application.

6.7.2 Other restrictions

To protect the integrity of an SR OS system, a number of facilities are disabled in Python while executing an application on SR OS. These include, but are not limited to the following:

- importing additional libraries outside of the supported list
- creating, reading, writing, or otherwise manipulating network sockets
- garbage collection
- debugging libraries

6.7.3 Memory management

SR OS does not allow a Python application to start if there is insufficient memory available at the point of execution, or if too many Python applications are running concurrently.

When a Python 3 application is spawned, SR OS confirms that the minimum percentage of sufficient free system memory is available. The percentage value for minimum available system memory is configurable within the MD-CLI environment settings.

The Python 3 application then reserves memory incrementally (and automatically) for the application up to the value of the maximum memory configured in the MD-CLI environment settings.

6.7.4 Performance and scale

The ability to execute Python applications conveys no expectation of a specific performance or scale level.



Note: Nokia recommends using smaller data sets, where possible, when executing a Python application on an SR OS device. For larger data sets, Nokia recommends executing Python applications remotely.

7 Event and accounting logs

7.1 Logging overview

The two primary types of logging supported in the OS are event logging and accounting logs.

Event logging controls the generation, dissemination and recording of system events for monitoring status and troubleshooting faults within the system. The OS groups events into four major categories or event sources.

| | |
|------------------------|---|
| security events | events that pertain to attempts to breach system security |
| change events | events that pertain to the configuration and operation of the node |
| main events | events that pertain to applications that are not assigned to other event categories/sources |
| debug events | events that pertain to trace or other debugging information |

Events within the OS and have the following characteristics:

- a time stamp in UTC or local time
- the generating application
- a unique event ID within the application
- a router name (also called a vrtr-name) identifying the associated routing context (for example, Base or vprn1000)
- a subject identifying the affected object for the event (for example, interface name or port identifier)
- a short text description

Event control assigns the severity for each application event and whether the event should be generated or suppressed. The severity numbers and severity names supported in the OS conform to ITU standards *M.3100 X.733 & X.21* and are listed in [Table 37: Event severity levels](#).

Table 37: Event severity levels

| Severity number | Severity name |
|-----------------|----------------------|
| 1 | cleared |
| 2 | indeterminate (info) |
| 3 | critical |
| 4 | major |
| 5 | minor |
| 6 | warning |

Events that are suppressed by event control do not generate any event log entries. Event control maintains a count of the number of events generated (logged) and dropped (suppressed) for each application event. The severity of an application event can be configured in event control.

An event log within the OS associates the event sources with logging destinations. Examples of logging destinations include the console session, a specific Telnet or SSH session, memory logs, file destinations, SNMP trap groups and syslog destinations. A log filter policy can be associated with the event log to control which events are logged in the event log based on combinations of application, severity, event ID range, router name (vrtr-name), and the subject of the event.

The OS accounting logs collect comprehensive accounting statistics to support a variety of billing models. The routers collect accounting data on services and network ports on a per-service class basis. In addition to gathering information critical for service billing, accounting records can be analyzed to provide insight about customer service trends for potential service revenue opportunities. Accounting statistics on network ports can be used to track link utilization and network traffic pattern trends. This information is valuable for traffic engineering and capacity planning within the network core.

Accounting statistics are collected according to the options defined within the context of an accounting policy. Accounting policies are applied to customer Service Access Points (SAPs) and network ports. Accounting statistics are collected by counters for individual service queues defined on the customer's SAP or by the counters within forwarding class (FC) queues defined on the network ports.

The type of record defined within the accounting policy determines where a policy is applied, what statistics are collected and time interval at which to collect statistics.

The supported destination for an accounting log is a compact flash system device. Accounting data is stored within a standard directory structure on the device in compressed XML format. On platforms that support multiple storage devices, Nokia recommends that accounting logs be configured on the cf1: or cf2: devices only. Accounting log files are not recommended on the cf3: device if other devices are available (Nokia recommends that cf3: be used primarily for software images and configuration related files).

7.2 Log destinations

Both event logs and accounting logs use a common mechanism for referencing a log destination. Log destinations are described in subsequent sections.

Only a single log destination can be associated with an event log or with an accounting log. An event log can be associated with multiple event sources, but it can only have a single log destination.

A file destination is the only type of log destination that can be configured for an accounting log.

7.2.1 Console

Sending events to a console destination means the message is sent to the system console. The console device can be used as an event log destination.

7.2.2 Session

A session destination is a temporary log destination which directs entries to the active Telnet or SSH session for the duration of the session. When the session is terminated, for example, when the user logs out, the "to session" configuration is removed. Event logs configured with a session destination are stored

in the configuration file but the "to session" part is not stored. Event logs can direct log entries to the session destination.

7.2.3 CLI logs

A CLI log is a log that outputs log events to a CLI session. The events are sent to the CLI session for the duration of that CLI session (or until an **unsubscribe-from** command is issued).

Use the following command to subscribe to a CLI log from within a CLI session.

```
tools perform log subscribe-to log-id
```

7.2.4 Memory logs

A memory log is a circular buffer. When the log is full, the oldest entry in the log is replaced with the new entry. When a memory log is created, the specific number of entries it can hold can be specified, otherwise it assumes a default size. An event log can send entries to a memory log destination.

7.2.5 Log and accounting files

Log files can be used by both event logs and accounting logs and are stored on the compact flash devices in the file system.

A log file policy is identified using a numerical ID in classic interfaces and a string name in MD interfaces, but a log file policy is generally associated with a number of individual files in the file system. A log file policy is configured with rollover, expressed in minutes, which represents the period of time an individual log file is written to before a new file is created for the relevant log file policy. The rollover time is checked only when an update to the log is performed. Therefore, complying to this rule is subject to the incoming rate of the data being logged. For example, if the rate is very low, the actual rollover time may be longer than the configured value.

The retention time for a log file policy specifies the amount of time an individual log file is retained on the system based on the creation date and time of the file. The system continuously checks for log files with expired retention periods once every hour and deletes as many files as possible during a 10-second interval.

When a log file policy is created, only the compact flash device for the log files is specified. Log files are created in specific subdirectories with standardized names depending on the type of information stored in the log file.

Event log files are always created in the `\log` directory on the specified compact flash device. The naming convention for event log files is:

log *eeff-timestamp*

where

- *ee* is the event log ID
- *ff* is the log file destination ID
- *timestamp* is the timestamp when the file is created in the form of:

yyyymmdd-hhmmss

where

- *yyyy* is the four-digit year (for example, 2019)
- *mm* is the two digit number representing the month (for example, 12 for December)
- *dd* is the two digit number representing the day of the month (for example, 03 for the 3rd of the month)
- *hh* is the two digit hour in a 24-hour clock (for example, 04 for 4 a.m.)
- *mm* is the two digit minute (for example, 30 for 30 minutes past the hour)
- *ss* is the two digit second (for example, 14 for 14 seconds)

Accounting log files are created in the `\act-collect` directory on a compact flash device (specifically `cf1` or `cf2`). The naming convention for accounting log files is nearly the same as for log files except the prefix `act` is used instead of the prefix `log`. The naming convention for accounting logs is:

```
act_aaff-timestamp.xml.gz
```

where:

- *aa* is the accounting policy ID
- *ff* is the log file destination ID
- *timestamp* is the timestamp when the file is created in the form of *yyyymmdd-hhmmss* where:
 - *yyyy* is the four-digit year (for example, 2019)
 - *mm* is the two digit number representing the month (for example, 12 for December)
 - *dd* is the two digit number representing the day of the month (for example, 03 for the 3rd of the month)
 - *hh* is the two digit hour in a 24-hour clock (for example, 04 for 4 a.m.)
 - *mm* is the two digit minute (for example, 30 for 30 minutes past the hour)
 - *ss* is the two digit second (for example, 14 for 14 seconds)

Accounting logs are `.xml` files created in a compressed format and have a `.gz` extension.

Active accounting logs are written to the `\act-collect` directory. When an accounting log is rolled over, the active file is closed and archived in the `\act` directory before a new active accounting log file is created in `\act-collect`.

When creating a new event log file on a compact flash disk card, the system checks the amount of free disk space and that amount must be greater than or equal to the lesser of 5.2 MB or 10% of the compact flash disk capacity.

In addition to the 10% free space limit for event log files described in the preceding paragraph, configurable limits for the total size of all system-generated log files and all accounting files on each storage device are available using the following commands:

- ```
configure log file-storage-control accounting-files-total-size
```
- ```
configure log file-storage-control log-files-total-size
```

The space on each storage device (`cf1`, `cf2`, and so on) is independently limited to the same configured value.

The following figure illustrates the file space limits.

Figure 18: Accounting and log file storage limits

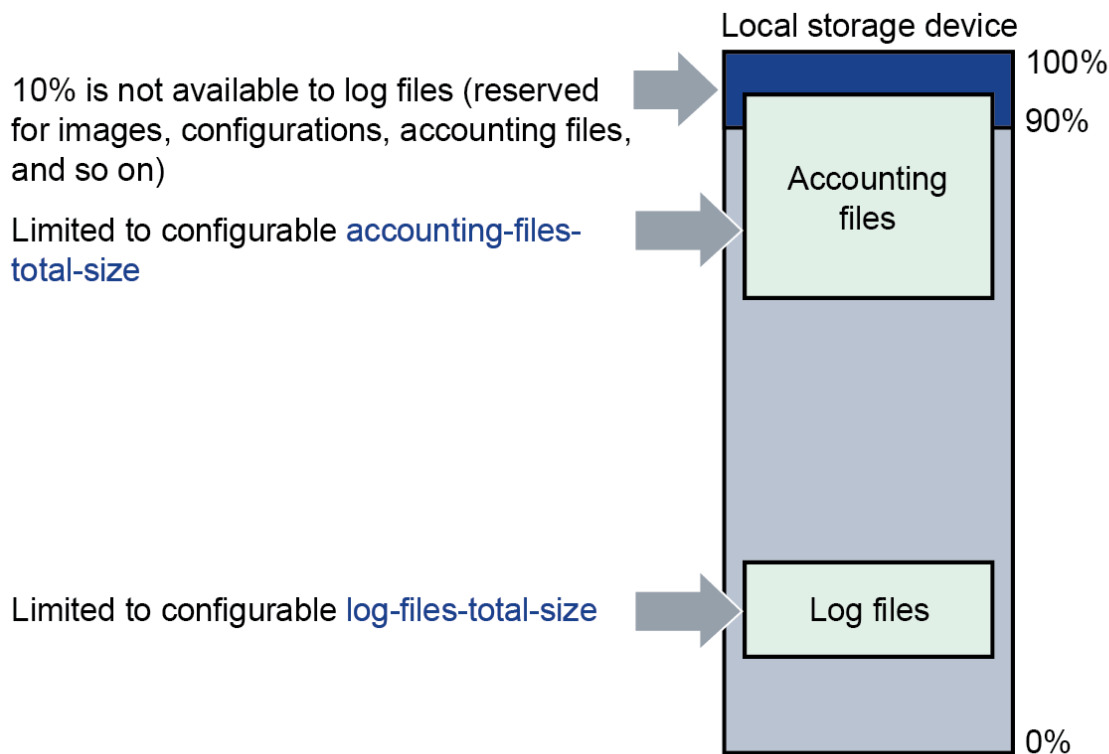

sw1331

The system calculates the total size of all accounting files and log files on each storage device on the active CPM every hour. The storage space used on the standby CPM is not actively managed. If a user manually adds or deletes accounting or log files in the `\act` or `\log` directories, the total size of the files is taken into account during the next hourly calculation cycle. Files added by the system (that is, a new log file after a rollover period ends) or removed by the system (that is, a file that is determined as past the retention time during the hourly checks) are immediately accounted for in the total size.

If the configured limit is reached, the system attempts a cleanup to generate free space, as follows:

1. Completed files beyond their retention time are removed.
2. If the total size of all log files is still above the configured limit for a specific storage device, the oldest completed log files are removed until the total log size is below the limit. Accounting files below their retention time are not removed.

Whether the configurable total size limits are configured or not, log and accounting files never overwrite other types of files, such as images, configurations, persistency, and so on.

7.2.5.1 Log file encryption

The log files saved in local storage can be encrypted using the AES-256-CTR cipher algorithm. The encryption key is used for all local log files in the system.

Use the following command to configure the log file encryption key and enable log file encryption.

```
configure log encryption-key
```

**Note:**

- When you open an encrypted log file in a text editor, you cannot edit or view its contents because the entire file is encrypted.
- You can decrypt encrypted log files offline using the appropriate OpenSSL command.

```
openssl enc aes-256-ctr -pbkdf2 -d -in <log file encrypted> -out <output log file> -p -pass pass:<passphrase>
```

7.2.6 SNMP trap group

An event log can be configured to send events to SNMP trap receivers by specifying an SNMP trap group destination.

An SNMP trap group can have multiple trap targets. Each trap target can have different operational values.

A trap destination has the following properties:

- The IP address of the trap receiver.
- The UDP port used to send the SNMP trap.
- SNMP version (v1, v2c, or v3) used to format the SNMP notification.
- SNMP community name for SNMPv1 and SNMPv2c receivers.
- Security name and level for SNMPv3 trap receivers.

For SNMP traps that are sent out-of-band through the Management Ethernet port on the SF/CPM, the source IP address of the trap is the IP interface address defined on the Management Ethernet port. For SNMP traps that are sent in-band, the source IP address of the trap is the system IP address of the router.

Each trap target destination of a trap group receives the identical sequence of events as defined by the log ID and the associated sources and log filter applied. For the list of options that can be sent in SNMP notifications, please see the SR OS MIBs (and RFC 3416, section 4.2.6).

7.2.7 Syslog

7.2.7.1 Syslog implementation overview

An event log can be configured to send events to one syslog destination. Syslog destinations have the following properties:

- Syslog server IP address
- UDP port or TLS profile used to send the syslog message
- Syslog Facility Code (0 to 23) (default 23 - local 7)
- Syslog Severity Threshold (0 to 7); sends events exceeding the configured level

Because syslog uses eight severity levels whereas the router uses six internal severity levels, the severity levels are mapped to syslog severities. The following table describes the severity level mappings to syslog severities.

Table 38: Router to syslog severity level mappings

| SR OS event severity | Syslog severity numerical code | Syslog severity name | Syslog severity definition |
|--------------------------|--------------------------------|----------------------|----------------------------------|
| — | 0 | emergency | System is unusable |
| critical | 1 | alert | Action must be taken immediately |
| major | 2 | critical | Critical conditions |
| minor | 3 | error | Error conditions |
| warning | 4 | warning | Warning conditions |
| — | 5 | notice | Normal but significant condition |
| cleared or indeterminate | 6 | info | Informational messages |
| — | 7 | debug | Debug-level messages |

The general format of an SR OS syslog message is the following, as defined in RFC 3164, *The BSD Syslog Protocol*:

<PRI><HEADER> <MSG>



Note: The "<" and ">" are informational delimiters to make reading and understanding the format easier and they do not appear in the actual syslog message except as part of the PRI.

where:

- <PRI> is a number that is calculated from the message Facility and Severity codes as follows:

Facility * 8 + Severity

The calculated PRI value is enclosed in "<" and ">" angle brackets in the transmitted syslog message.

- <HEADER> is composed of the following:

<TIMESTAMP> <HOSTNAME>

- <TIMESTAMP> immediately follows the trailing ">" from the PRI part, without a space between. The format is:

MMM DD HH:MM:SS

There are always 2 characters for the day (DD). Single digit days are preceded with a space character. Either UTC or local time is used, depending on the configuration of the **time-format** command for the event log.

—

- <HOSTNAME> follows the <TIMESTAMP> with a space between. It is an IP address by default, or can be configured to use other values using the following commands:

```
configure log syslog hostname
configure service vprn log syslog hostname
```

- <MSG> is composed of the following:

```
<log-prefix>: <seq> <vrtr-name> <application>-<severity>-<Event Name>-<Event ID> [<subject>]:
<message>\n
```

- <log-prefix> is an optional 32 characters of text (default = 'TMNX') as configured using the **log-prefix** command.
- <seq> is the log event sequence number (always preceded by a colon and a space char)
- <vrtr-name> is vprn1, vprn2, ... | Base | management | vpls-management
- <subject> may be empty resulting in []:
- \n is the standard ASCII newline character (0x0A)

Examples (from different nodes)

default log-prefix (TMNX):

```
<188>Jan 2 18:43:23 10.221.38.108 TMNX: 17 Base SYSTEM-WARNING-tmnxStateChange-
2009 [CHASSIS]: Status of Card 1 changed administrative state: inService,
operational state: outOfService\n
<186>Jan 2 18:43:23 10.221.38.108 TMNX: 18 Base CHASSIS-MAJOR-tmnxEqCardRemoved-
2003 [Card 1]: Class IO Module : removed\n
```

no log-prefix:

```
<188>Jan 11 18:48:12 10.221.38.108 : 32 Base SYSTEM-WARNING-tmnxStateChange-2009
[CHASSIS]: Status of Card 1 changed administrative state: inService,
operational state: outOfService\n
<186>Jan 11 18:48:12 10.221.38.108 : 33 Base CHASSIS-MAJOR-tmnxEqCardRemoved-
2003 [Card 1]: Class IO Module : removed\n
```

log-prefix "test":

```
<186>Jan 11 18:51:22 10.221.38.108 test: 47 Base CHASSIS-MAJOR-tmnxEqCardRemoved-
2003 [Card 1]: Class IO Module : removed\n
<188>Jan 11 18:51:22 10.221.38.108 test: 48 Base SYSTEM-WARNING-tmnxStateChange-
2009 [CHASSIS]: Status of Card 1 changed administrative state: inService,
operational state: outOfService\n
```

Syslog IP header source address

The source IP address field of the IP header on syslog message packets depends on a number of factors including which interface the message is transmitted on and a few configuration commands.

When a syslog packet is transmitted out-of-band (out a CPM Ethernet port in the management router instance), the source IP address contains the address of the management interface as configured in the BOF.

When a syslog packet is transmitted in-band (for example, out a port on an IMM) in the Base router instance, the order of precedence for how the source IP address is populated is the following:

MD-CLI

1. source address

```
configure system security source-address ipv4 syslog
configure system security source-address ipv6 syslog
```

2. system address

```
configure router interface "system" ipv4 primary address
configure router interface "system" ipv6 address
```

3. IP address of the outgoing interface**Classic CLI****1. source address**

```
configure system security source-address application syslog
configure system security source-address application6 syslog
```

2. system address

```
configure router interface "system" address
configure router interface "system" ipv6 address
```

3. IP address of the outgoing interface

When a syslog packet is transmitted out a VPRN interface, the source IP address is populated with the IP address of the outgoing interface.

Syslog HOSTNAME

The HOSTNAME field of syslog messages can be populated with an IP address, the system name, or a number of other options.

Use the following commands if a system name or other string is wanted.

```
configure log syslog hostname
configure service vprn log hostname
```

If the **hostname** command is not configured, SR OS populates the syslog HOSTNAME field with an IP address as follows.

When a syslog packet is transmitted out-of-band (out a CPM Ethernet port in the management router instance), the HOSTNAME field contains the address of the management interface as configured in the BOF.

When a syslog packet is transmitted in-band (for example, out a port on an IMM) in the Base router instance, the order of precedence for how the source IP address is populated is the following:

MD-CLI**1. source address**

```
configure system security source-address ipv4 syslog
configure system security source-address ipv6 syslog
```

2. system address

```
configure router interface "system" ipv4 primary address
```

```
configure router interface "system" ipv6 address
```

3. lowest loopback address

4. lowest exit address

Classic CLI

1. source address

```
configure system security source-address application syslog
configure system security source-address application6 syslog
```

2. system address

```
configure router interface "system" address
configure router interface "system" ipv6 address
```

3. lowest loopback address

4. lowest exit address

When a syslog packet is transmitted out a VPRN interface, the HOSTNAME is populated with the VPRN loopback address. When more than one loopback exists, the HOSTNAME contains the lowest loopback IP address. If no loopback interface is configured, the HOSTNAME contains the physical exit interface IP address. When no loopback interface is configured and more than one physical exit interface exists, the hostname contains the lowest physical exit interface IP address.

7.2.7.2 Syslog over TLS for log events

Syslog messages containing log events can be optionally sent over TLS instead of UDP. TLS support for log event syslog messages is based on RFC 5425, which provides security for syslog through the use of encryption and authentication.

To enable the use of TLS for syslog log events, configure a TLS profile against the syslog profile. The following example shows the configuration of a TLS profile against the syslog profile.

Example

```
configure log syslog "3" tls-client-profile "secure-44"
```

Syslog over TLS packets are sent with a fixed TCP source port of 6514.

TLS is supported for the following log event syslogs:

- system syslogs (**configure log syslog**), which can send syslog messages as follows:
 - in-band (for example, out a port on an IMM)
 - out-of-band (out a CPM Ethernet port in the management router instance)

The **configure log route-preference** command configuration determines where the TLS connection is established for the base system syslogs.

- service VPRN syslogs (**configure service vprn log syslog**)

7.2.8 NETCONF

A NETCONF log is a log that outputs log events to a NETCONF session as notifications. A NETCONF client can subscribe to a NETCONF log using the configured **netconf-stream stream-name** for the log in a subscription request. See [NETCONF notifications](#) for more details.

7.3 Event logs

Event logs are the means of recording system generated events for later analysis. Events are messages generated by the system by applications or processes within the router.

Figure 19: Event logging block diagram depicts a function block diagram of event logging.

Figure 19: Event logging block diagram

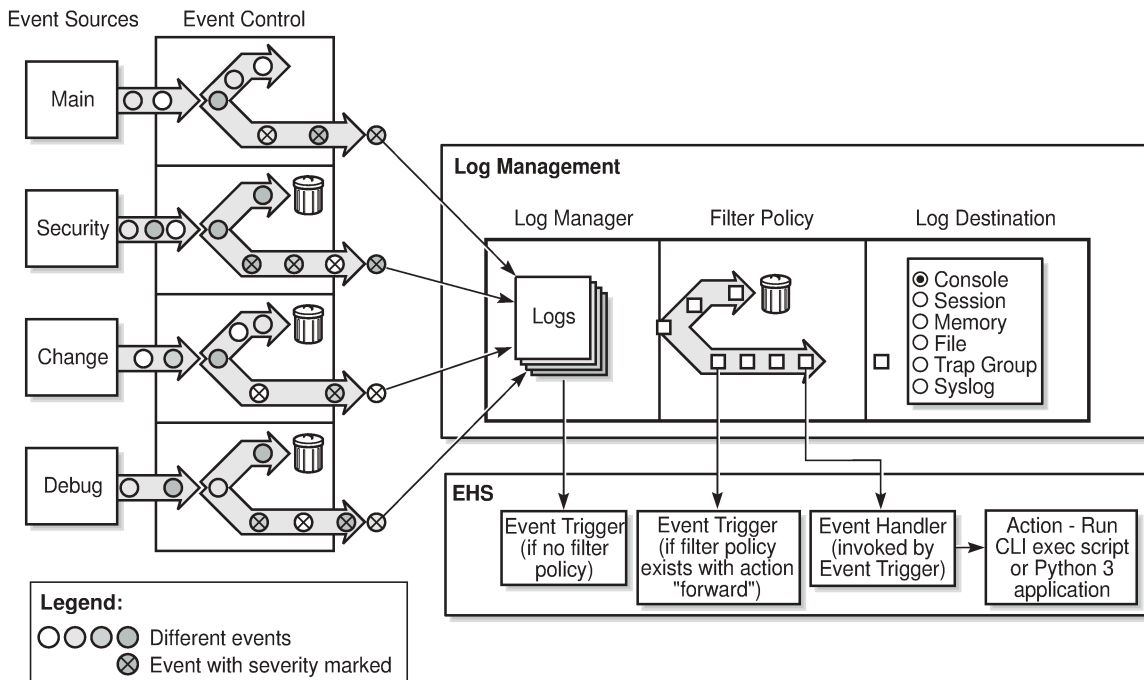

27853

7.3.1 Event sources

In [Figure 19: Event logging block diagram](#), the event sources are the main categories of events that feed the log manager.

- **security**

The security event source is all events that affect attempts to breach system security such as failed login attempts, attempts to access MIB tables to which the user is not granted access or attempts to enter a branch of the CLI to which access has not been granted. Security events are generated by the SECURITY application, as well as several other applications (TLS for example).

- **change**

The change activity event source is all events that directly affect the configuration or operation of the node. Change events are generated by the USER application. The Change event stream also includes the `tmnxConfigModify` (#2006), `tmnxConfigCreate` (#2007), `tmnxConfigDelete` (#2008) and `tmnxStateChange` (#2009) change events from the SYSTEM application, as well as the various `xxxConfigChange` events from the MGMT_CORE application.

- **debug**

The debug event source is the debugging configuration that has been enabled on the system. Debug events are generated when debug is enabled for various protocols under the **debug** branch of the CLI (for example, **debug system ntp**).

- **li**

The li event source generates lawful intercept events from the LI application.

- **main**

The main event source generates events from all other applications within the router.

The event source for a particular log event is displayed in the output of the **show log event-control detail** command, and can also be found in the **source-stream** element in the **state log log-events** context.

Use the following command to show the list of event log applications.

```
show log applications
```

The following example shows partial output of the **show log applications** command. Examples of event log applications within the system include IP, MPLS, OSPF, CLI, services, and so on.

Output example

```
=====
Log Event Application Names
=====
Application Name
-----
...
BGP
CCAG
CFLOWD
CHASSIS
...
MPLS
MSDP
NTP
...
USER
VRRP
VRTR
=====
```

7.3.2 Event control

Event control pre-processes the events generated by applications before the event is passed into the main event stream. Event control assigns a severity to application events and can either forward the event to the main event source or suppress the event. Suppressed events are counted in event control, but these events do not generate log entries as it never reaches the log manager.

Simple event throttling is another method of event control and is configured similarly to the generation and suppression options. See [Simple logger event throttling](#).

Events are assigned a default severity level in the system, but the application event severities can be changed by the user.

Application events contain an event number and description that describes why the event is generated. The event number is unique within an application, but the number can be duplicated in other applications.

Use the following command to display log event information.

```
show log event-control
```

The following example, generated by querying event control for application generated events, displays a partial list of event numbers and names.

Output example

```
=====
Log Events
=====
Application
ID#      Event Name                P  g/s   Logged   Dropped
-----
show
BGP:
  2001  bgpEstablished           MI  gen    1         0
  2002  bgpBackwardTransition    WA  gen    7         0
  2003  tBgpMaxPrefix90         WA  gen    0         0
...
CCAG:
CFLOWD:
  2001  cflowdCreated           MI  gen    1         0
  2002  cflowdCreateFailure     MA  gen    0         0
  2003  cflowdDeleted           MI  gen    0         0
...
CHASSIS:
  2001  cardFailure             MA  gen    0         0
  2002  cardInserted            MI  gen    4         0
  2003  cardRemoved             MI  gen    0         0
...
'''
DEBUG:
L 2001  traceEvent              MI  gen    0         0
DOT1X:
FILTER:
  2001  filterPBRPacketsDropped MI  gen    0         0
IGMP:
  2001  vRtrIgmpIfRxQueryVerMismatch WA  gen    0         0
  2002  vRtrIgmpIfCModeRxQueryMismatch WA  gen    0         0
IGMP_SNOOPING:
IP:
L 2001  clearRTMError           MI  gen    0         0
L 2002  ipEtherBroadcast        MI  gen    0         0
L 2003  ipDuplicateAddress       MI  gen    0         0
...
ISIS:
  2001  vRtrIisisDatabaseOverload WA  gen    0         0
```

7.3.3 Log manager and event logs

Events that are forwarded by event control are sent to the log manager. The log manager manages the event logs in the system and the relationships between the log sources, event logs and log destinations, and log filter policies.

An event log has the following properties:

- **a unique log ID**

The log ID is a short, numeric identifier for the event log. A maximum of 30 logs can be configured at a time.

- **one or more log sources**

The source stream or streams to be sent to log destinations can be specified. The source must be identified before the destination can be specified. The events can be from the main event stream, events in the security event stream, or events in the user activity stream.

- **one event log destination**

A log can only have a single destination (for example, syslog or memory).

- **an optional event filter policy**

An event filter policy defines whether to forward or drop an event or trap-based on match criteria.

7.3.4 Event filter policies

The log manager uses event filter policies to allow fine control over which events are forwarded or dropped based on various criteria. Like other filter policies in the SR OS, filter policies have a default action. The default actions are either:

- Forward
- Drop

Filter policies also include a number of filter policy entries that are identified with an entry ID and define specific match criteria and a forward or drop action for the match criteria.

Each entry contains a combination of matching criteria that define the application, message, event number, router, severity, and subject conditions. The entry's action determines how the packets should be treated if they have met the match criteria.

Entries are evaluated in order from the lowest to the highest entry ID. The first matching event is subject to the forward or drop action for that entry.

Valid operators are displayed in [Table 39: Valid filter policy operators](#).

Table 39: Valid filter policy operators

| Operator | Description |
|----------|--------------|
| eq | equal to |
| neq | not equal to |
| lt | less than |

| Operator | Description |
|----------|--------------------------|
| lte | less than or equal to |
| gt | greater than |
| gte | greater than or equal to |

A match criteria entry can include combinations of:

- Equal to or not equal to a specific system application.
- Equal to or not equal to an event message string or regular expression match.
- Equal to, not equal to, less than, less than or equal to, greater than or greater than or equal to an event number within the application.
- Equal to, not equal to, less than, less than or equal to, greater than or greater than or equal to a severity level.
- Equal to or not equal to a router name string or regular expression match.
- Equal to or not equal to an event subject string or regular expression match.

7.3.5 Event log entries

Log entries that are forwarded to a destination are formatted in a way appropriate for the specific destination whether it be recorded to a file or sent as an SNMP trap, but log event entries have common elements or properties. All application generated events have the following properties:

- A time stamp in UTC or local time.
- The generating application.
- A unique event ID within the application.
- A router name identifying the router instance that generated the event.
- A subject identifying the affected object.
- A short text description.

The general format for an event in an event log with either a memory, console or file destination is as follows.

```
nnnn <time> TZONE <severity>: <application> #<event-id> <vrtr-name> <subject>
<message>
```

The following is an event log example:

```
252 2013/05/07 16:21:00.761 UTC WARNING: SNMP #2005 Base my-interface-abc
"Interface my-interface-abc is operational"
```

The specific elements that compose the general format are described in [Table 40: Log entry field descriptions](#).

Table 40: Log entry field descriptions

| Label | Description |
|------------------|--|
| n ⁿⁿⁿ | The log entry sequence number. |
| <time> | YYYY/MM/DD HH:MM:SS.SSS |
| YYYY/MM/DD | The UTC date stamp for the log entry: <ul style="list-style-type: none"> • YYYY: Year • MM: Month • DD: Date |
| HH:MM:SS.SSS | The UTC time stamp for the event: <ul style="list-style-type: none"> • HH: Hours (24 hour format) • MM: Minutes • SS.SSS: Seconds |
| TZONE | The timezone (for example, UTC, EDT) as configured by the following command. <pre>configure log log-id x time-format</pre> |
| <severity> | The severity levels of the event: <ul style="list-style-type: none"> • CRITICAL: a critical severity event • MAJOR: a major severity event • MINOR: a minor severity event • WARNING: a warning severity event • CLEARED: a cleared event • INDETERMINATE: an indeterminate/informational severity event <p> Note: The term "INFO" may appear in messages in management interfaces indicating a situation that is less impactful than a "WARNING", or a situation that has an indeterminate impact, but "INFO" is not a log event severity in SR OS.</p> |
| <application> | The application generating the log message. |
| <event-id> | The application's event ID number for the event. |
| <vrtr-name> | The router name in a special format used by the logging system (for example, Base or vprn101, where 101 represents the service-id of the VPRN service), representing the router instance that generated the event. |
| <subject> | The subject/affected object for the event. |

| Label | Description |
|-----------|----------------------------------|
| <message> | A text description of the event. |

7.3.6 Simple logger event throttling

Simple event throttling provides a mechanism to protect event receivers from being overloaded when a scenario causes many events to be generated in a very short period of time. A throttling rate, # events/# seconds, can be configured. Specific event types can be configured to be throttled. When the throttling event limit is exceeded in a throttling interval, any further events of that type cause the dropped events counter to be incremented.

Use the commands in the following context to display dropped event counts.

```
show log event-control
```

Events are dropped before being sent to one of the logger event collector tasks. There is no record of the details of the dropped events and therefore no way to retrieve event history data lost by this throttling method.

A particular event type can be generated by multiple managed objects within the system. At the point this throttling method is applied the logger application has no information about the managed object that generated the event and cannot distinguish between events generated by object "A" from events generated by object "B". If the events have the same event-id, they are throttled regardless of the managed object that generated them. It also does not know which events may eventually be logged to destination log-id <n> from events that are logged to destination log-id <m>.

Throttle rate applies commonly to all event types. It is not configurable for a specific event-type.

A timer task checks for events dropped by throttling when the throttle interval expires. If any events have been dropped, a TIMETRA-SYSTEM-MIB::tmnxTrapDropped notification is sent.

7.3.7 Default system log

Log 99 is a pre-configured memory-based log which logs events from the main event source (not security, debug, and so on). Log 99 exists by default.

The following example displays the log 99 configuration.

Example: MD-CLI

```
[ex:/configure log]
A:admin@node-2# info
  log-id "99" {
    admin-state enable
    description "Default system log"
    source {
      main true
    }
    destination {
      memory {
        max-entries 500
      }
    }
  }
}
```

```
snmp-trap-group "7" {  
}
```

Example: classic CLI

```
A:node-2>config>log# info detail  
#-----  
echo "Log Configuration "  
#-----  
...  
    snmp-trap-group 7  
    exit  
...  
    log-id 99  
        description "Default system log"  
        no filter  
        from main  
        to memory 500  
        no shutdown  
    exit  
-----
```

7.3.8 Event handling system

The Event Handling System (EHS) is a framework that allows operator-defined behavior to be configured on the router. EHS adds user-controlled programmatic exception handling by allowing the execution of either a CLI script or a Python 3 application when a log event (the "trigger") is detected. Various fields in the log event provide regexp style expression matching, which allows flexibility for the trigger definition.

EHS handler objects are used to tie together the following:

- trigger events (typically log events that match a configurable criteria)
- a set of actions to perform (enabled using CLI scripts and Python applications)

EHS, along with CRON, may execute SR OS CLI scripts or Python 3 applications to perform operator-defined functions as a result of receiving a trigger event. The Python programming language provides an extensive framework for automation activities for triggered or scheduled events, including model-driven transactional configuration and state manipulation. See the [Python](#) chapter for more information.

The use of Python applications from EHS is supported only in model-driven configuration mode.

The following figure shows the relationships among the different configurable objects used by EHS (and CRON).

Figure 20: EHS object handling (MD-CLI)

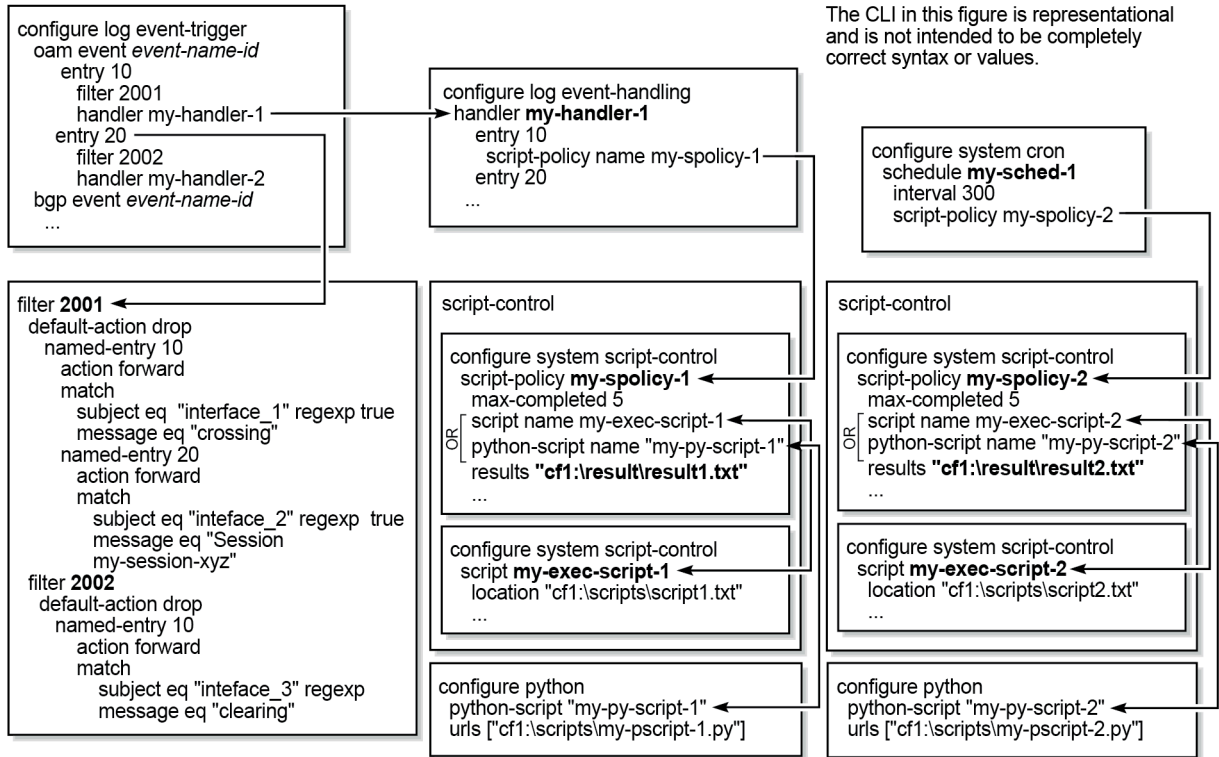

The CLI in this figure is representational and is not intended to be completely correct syntax or values.

swL356

Figure 21: EHS object handling (classic CLI)

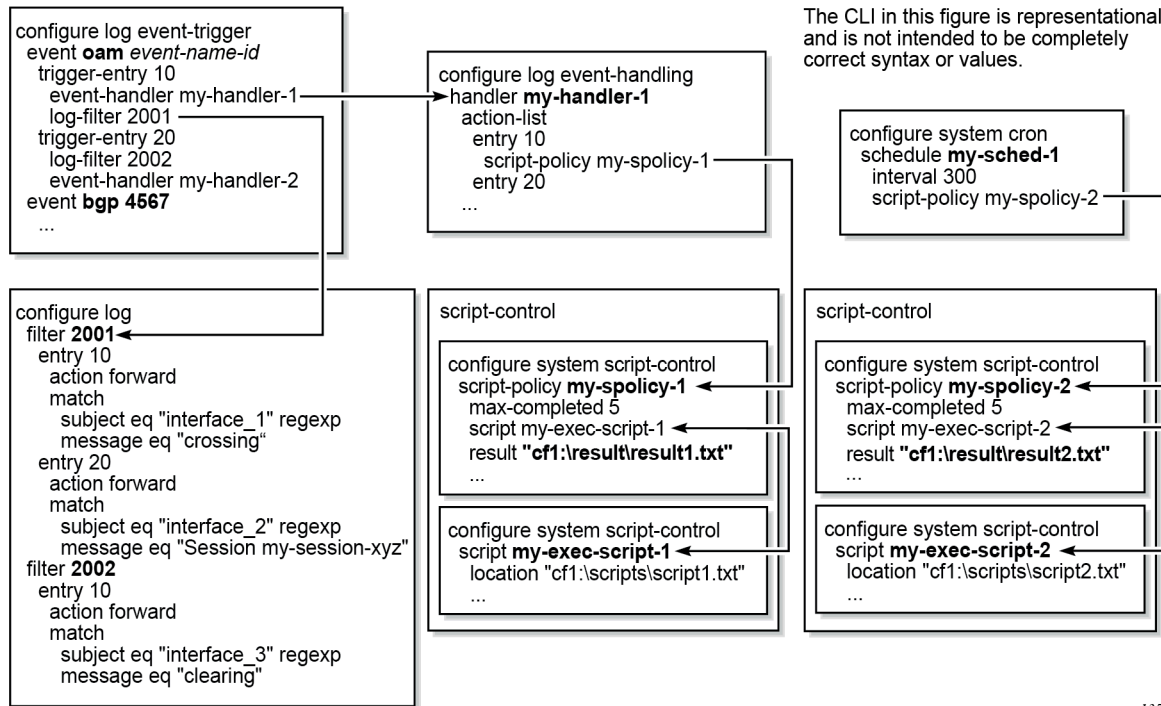

sw1355

7.3.8.1 EHS configuration and variables

You can configure complex rules to match log events as the trigger for EHS. For example, use the commands in the following context to configure discard using suppression and throttling:

- **MD-CLI**

```
configure log log-events
```

- **classic CLI**

```
configure log event-control
```

When a log event is generated in SR OS, it is subject to discard using the configured suppression and throttling before it is evaluated as a trigger for EHS, according to the following:

- EHS does not trigger on log events that are suppressed through the configuration.
- EHS does not trigger on log events that are throttled by the logger.

EHS is triggered on log events that are dropped by user-configured log filters assigned to individual logs.

Use the following command to assign log filters:

```
configure log filter
```

The EHS event trigger logic occurs before the distribution of log event streams into individual logs.

The parameters from the log event are passed into the triggered EHS CLI script or Python application. For CLI scripts, the parameters are passed as individual dynamic variables (for example, \$eventid). For Python applications, see the details in the following sections. The parameters are composed of:

- common events
- event specific options

The common event parameters are:

- appid
- eventid
- severity
- gentime (in UTC)
- timestamp (in seconds, available within a Python application only)

The event specific parameters depend on the log event. Use the following command to obtain information for a particular log event.

```
show log event-parameters
```

Alternatively, in the MD-CLI use the following command for information.

```
state log log-events
```



Note: The event sequence number is not passed into the script.

7.3.8.2 Triggering a CLI script from EHS

When using the classic CLI, an EHS script has the ability to define local (static) variables and uses basic `.if` or `.set` syntax inside the script. The use of variables with `.if` or `.set` commands within an EHS script adds more logic to the EHS scripting and allows the reuse of a single EHS script for more than one trigger or action.

Both passed-in and local variables can be used within an EHS script, either as part of the CLI commands or as part of the `.if` or `.set` commands.

The following applies to both CLI commands and `.if` or `.set` commands (where *X* represents a variable).

- Using `$X`, without using single or double quotes, replaces the variable *X* with its string or integer value.
- Using `"X"`, with double quotes, means the actual string *X*.
- Using `"$X"`, with double quotes, replaces the variable *X* with its string or integer value.
- Using `'X'`, with single quotes does not replace the variable *X* with its value but means the actual string `$X`.

The following interpretation of single and double quotes applies.

- All characters within single quotes are interpreted as string characters.
- All characters within double quotes are interpreted as string characters except for `$`, which replaces the variable with its value (for example, shell expansion inside a string).

7.3.8.2.1 Examples of EHS syntax supported in classic CLI

This section describes the supported EHS syntax for the classic CLI.



Note: These scenarios use pseudo syntax.

- `.if $string_variable==string_value_or_string_variable {
CLI_commands_set1
} else {
CLI_commands_set2
} endif`
- `.if ($string_variable==string_value_or_string_variable) {
CLI_commands_set1
} else {
CLI_commands_set2
} endif`
- `.if $integer_variable==integer_value_or_integer_variable {
CLI_commands_set1
} else {
CLI_commands_set2
} endif`
- `.if ($integer_variable==integer_value_or_integer_variable) {
CLI_commands_set1
} else {
CLI_commands_set2
} endif`
- `.if $string_variable!=string_value_or_string_variable {
CLI_commands_set1
} else {
CLI_commands_set2
} endif`
- `.if ($string_variable!=string_value_or_string_variable) {
CLI_commands_set1
} else {
CLI_commands_set2
} endif`
- `.if $integer_variable!=integer_value_or_integer_variable {
CLI_commands_set1`

```

    } else {
    CLI_commands_set2
    } endif
• .if ($integer_variable!=integer_value_or_integer_variable) {
  CLI_commands_set1
  } else {
  CLI_commands_set2
  } endif
• .set $string_variable = string_value_or_string_variable
• .set ($string_variable = string_value_or_string_variable)
• .set $integer_variable = integer_value_or_integer_variable
• .set ($integer_variable = integer_value_or_integer_variable)

```

where:

- *CLI_commands_set1* is a set of one or more CLI commands
- *CLI_commands_set2* is a set of one or more CLI commands
- *string_variable* is a local (static) string variable
- *string_value_or_string_variable* is a string value/variable
- *integer_variable* is a local (static) integer variable
- *integer_value_or_integer_variable* is an integer value/variable



Note:

- A limit of 100 local (static) variables per EHS script is imposed. Exceeding this limit may result in an error and partial execution of the script.
- When a set statement is used to set a *string_variable* to a *string_value*, the *string_value* can be any non-integer value not surrounded by single or double quotes or it can be surrounded by single or double quotes.
- A "." preceding a directive (for example, if, set, and so on) is always expected to start a new line.
- An end of line is always expected after {.
- A CLI command is always expected to start a new line.
- Passed-in (dynamic) variables are always read-only inside an EHS script and cannot be overwritten using a set statement.
- .if commands support == and != operators only.
- .if and .set commands support addition, subtraction, multiplication, and division of integers.
- .if and .set commands support addition, which means concatenation, of strings.

7.3.8.2.2 Valid examples of EHS syntax in classic CLI

This section provides a list of valid examples to trigger log events using EHS syntax in classic CLI.

- configure service epipe \$serviceID
where \$serviceID is either a local (static) integer variable or passed-in (dynamic) integer variable
- echo srcAddr is \$srcAddr
where \$srcAddr is a passed-in (dynamic) string variable
- .set \$ipAddr = "10.0.0.1"
where \$ipAddr is a local (static) string variable
- .set \$ipAddr = \$srcAddr
where \$srcAddr is a passed-in (dynamic) string variable
\$ipAddr is a local (static) string variable.
- .set (\$customerID = 50)
where \$customerID is a local (static) integer variable
- .set (\$totalPackets = \$numIngrPackets + \$numEgrPackets)
where \$totalPackets, \$numIngrPackets, \$numEgrPackets are local (static) integer variables
- .set (\$portDescription = \$portName + \$portLocation)
where \$portDescription, \$portName, \$portLocation are local (static) string variables
- if (\$srcAddr == "CONSOLE") {
CLI_commands_set1
.else {
CLI_commands_set2
.} endif
where \$srcAddr is a passed-in (dynamic) string variable
CLI_commands_set1 is a set of one or more CLI commands
CLI_commands_set2 is a set of one or more CLI commands
- .if (\$customerID == 10) {
CLI_commands_set1
.else {
CLI_commands_set2
.} endif
where \$customerID is a passed-in (dynamic) integer variable CLI_commands_set1 is a set of one or more CLI commands
CLI_commands_set2 is a set of one or more CLI commands
- .if (\$numIngrPackets == \$numEgrPackets) {
CLI_commands_set1
.else {
CLI_commands_set2
.} endif
where \$numIngrPackets and \$numEgrPackets are local (static) integer variables

CLI_commands_set1 is a set of one or more CLI commands

CLI_commands_set2 is a set of one or more CLI commands

7.3.8.2.3 Invalid examples for EHS syntax in classic CLI

This section provides a list of invalid variable use in EHS syntax in classic CLI.

- `.set $srcAddr = "10.0.0.1"`
 where *\$srcAddr* is a passed-in (dynamic) string variable
 Reason: passed-in variables are read only inside an EHS script.
- `.set ($ipAddr = $numIngrPackets + $numEgrPackets)`
 where *\$ipAddr* is a local (static) string variable
\$numIngrPackets and *\$numEgrPackets* are local (static) integer variables
 Reason: variable types do not match, cannot assign a string to an integer.
- `.set ($numIngrPackets = $ipAddr + $numEgrPackets)`
 where *\$ipAddr* is a local (static) string variable
\$numIngrPackets and *\$numEgrPackets* are local (static) integer variables
 Reason: variable types do not match, cannot concatenate a string to an integer.
- `.set $ipAddr = "10.0.0.1"100`
 where *\$ipAddr* is a local (static) string variable
 Reason: when double quotes are used, they have to surround the entire string.
- `.if ($totalPackets == "10.1.1.1") {
 .} endif`
 where *\$totalPackets* is a local (static) integer variables
 Reason: cannot compare an integer variable to a string value.
- `.if ($ipAddr == 10) {
 .} endif`
 where *\$ipAddr* is a local (static) string variable
 Reason: cannot compare a string variable to an integer value.
- `.if ($totalPackets == $ipAddr) {`
 where *\$totalPackets* is a local (static) integer variables
\$ipAddr is a local (static) string variable
 Reason: cannot compare an integer variable to a string variable.

7.3.8.3 Triggering a Python application from EHS

When using model-driven configuration mode and the MD-CLI, EHS can trigger a Python application that is executed inside a Python interpreter running on SR OS. See the [Python](#) chapter for more information.

Python applications are not supported in classic configuration mode or mixed configuration mode.

When developing an EHS Python application, the event attributes are passed to the application using the **get_event** function in the **pysros.ehs** module.

To import this module, the Python application developer must add the following statement to the application:

```
from pysros.ehs import get_event
```

Use the **get_event** function call to obtain the event triggered the Python application to run. The following example catches the event and returns a Python object into the event variable:

```
event = get_event()
```

When using an EHS Python application, the operator can use the Python programming language to create applications, as required. See the [Python](#) chapter for information about displaying model-driven state or configuration information, performing transactional configuration of SR OS, or executing CLI commands in Python.

Common event parameters (group one) are available in Python from the object created using the **get_event** function, as shown in the following table (the functions assume that the EHS event object is called **event**).

Table 41: Python `get_event` common parameters

| Function call | Description | Example output | Python return type |
|------------------------------|---|---|--------------------|
| <code>event.appid</code> | The name of the application that generated the event | SYSTEM | String |
| <code>event.eventid</code> | The event ID number of the application | 2068 | Integer |
| <code>event.severity</code> | The severity level of the event | minor | String |
| <code>event.subject</code> | The subject or affected object of the event | EHS script | String |
| <code>event.gentime</code> | The formatted time the event was generated in UTC | The timestamp in ISO 8601 format (consistent with state date/time leaves) that the event was generated. For example, 2021-03-08T11:52:06.0-05:00 | String |
| <code>event.timestamp</code> | The timestamp that the event was generated (in seconds) | 1632165026.921208 | Float |

The variables (group two) are available in Python in the event parameters attribute of the event object, as shown in the following table. They are presented as a Python dictionary (unordered).

Table 42: Variable parameters available in Python

| Function call | Description | Example output | Python return type |
|-----------------------|--|---|--------------------|
| event.eventparameters | The event specific variable parameters | <p><EventParams></p> <p>When calling keys() on this object the example output is:</p> <pre>(('tmnxEhsHandlerName', 'tmnxEhsHEntryId', 'tmnx EhsHEntryScriptPlcyOwner', 'tmnxEhsHEntryScript PlcyName', 'smLaunch Owner', 'smLaunchName', 'smLaunchScriptOwner', 'smLaunchScriptName', 'smLaunchError', 'tmnx SmLaunchExtAuthType', 'sm RunIndex', 'tmnxSmRunExt AuthType', 'tmnxSmRunExt UserName')</pre> | Dict |

In addition to the variables, the **format_msg()** function is provided to output the formatted log string from the event as it would appear in the output of the **show log** command. The following is an example usage.

```
print(event.format_msg())
```

The following shows an example output of the **format_msg()** function.

```
Launch of none operation failed with a error: Python script's operational status is not 'in
Service'.
The script policy "test_ehs" created by the owner "TiMOS CLI" was executed with cli-user
account "not-specified"
```

7.3.8.4 EHS debounce

EHS debounce (also called dampening) is the ability to trigger an action (for example an EHS script), if an event happens (N) times within a specific time window (S).

N = [2..15]

S = [1..604800]



Note:

- Triggering occurs with the Nth event not at the end of S.
- There is no sliding window (for example a trigger at Nth event, N+1 event, and so on), as N is reset after a trigger and count is restarted.
- When EHS debouncing or dampening is used, the varbinds passed in to an EHS script at script triggering time are from the Nth event occurrence (the Nth triggering event).

- If S is not specified, the SR OS continues to trigger every Nth event.

For example:

When linkDown occurs N times in S seconds, an EHS script is triggered to shut down the port.

7.3.8.5 Executing EHS or CRON CLI scripts or Python applications

The execution of EHS or CRON scripts depends on the CLI engine associated with the configuration mode. The EHS or CRON script execution engine is based on the configured primary CLI engine. For example, if **cli-engine** is configured to **md-cli**, the script executes in the MD-CLI infrastructure and disregards the configuration mode, even if it is classic.

Use the following command to configure the primary CLI engine.

```
configure system management-interface cli cli-engine
```

The following is the default behavior of the EHS or CRON scripts, depending on the configuration mode.

- **Model-Driven configuration mode**

EHS or CRON scripts execute in the MD-CLI environment and an error occurs if any classic CLI commands exist. Python applications are fully supported and use the SR OS model-driven interfaces and the pySROS libraries to obtain and manipulate state and configuration data, as well as pySROS API calls to execute MD-CLI commands.

- **classic CLI configuration mode**

EHS or CRON scripts execute in the classic CLI environment and an error occurs if any model-driven CLI commands exist. Python applications are not supported and the system returns an error.

- **mixed configuration mode**

EHS or CRON scripts execute in the classic CLI environment and an error occurs if any Model-Driven CLI commands exist. Python applications are not supported and the system returns an error.

EHS or CRON scripts that contain MD-CLI commands can be used in the MD-CLI as follows:

- scripts can be configured
- scripts can be created, edited, and results read through FTP
- scripts can be triggered and executed
- scripts generate an error if there are any non MD-CLI commands or .if or .set syntax in the script

Use the following command to configure user authorization for EHS or CRON scripts and Python applications.

```
configure system security cli-script authorization event-handler cli-user
```

When a user is not specified, an EHS or CRON script bypasses authorization and can execute all commands.

In all configuration modes, use the following command to disable a script policy, even if history exists:

- **MD-CLI**

```
configure system script-control script-policy admin-state disable
```

- **classic CLI**

```
configure system script-control script-policy shutdown
```

When the script policy is disabled, the following applies.

- Newly triggered EHS or CRON scripts or Python applications are not allowed to execute or queue.
- In-progress EHS or CRON scripts or Python applications are allowed to continue.
- Already queued EHS or CRON scripts or Python applications are allowed to execute.

By default, a script policy is configured to allow an EHS or CRON script to override datastore locks from any model-driven interface (MD-CLI, NETCONF, and so on) in mixed and model-driven modes. Use the following command to configure a script policy to prevent EHS or CRON scripts from overriding datastore locks:

- **MD-CLI**

```
configure system script-control script-policy lock-override false
```

- **classic CLI**

```
configure system script-control script-policy no lock-override
```

7.3.9 Managing logging in VPRNs

Log events can initiate from within a VPRN, instead of from the base router instance or the CPM management router instance. For example, a syslog collector may be reachable through a VPRN interface. Use the following command to configure event logs for a VPRN service.

```
configure service vprn log
```

By default, the event-source streams for VPRN event logs contain only events that are associated with that specific VPRN. It is also possible to configure a system-wide set of log events. This can be useful, for example, when a VPRN is being used as a management VPRN. Use the following command to send a VPRN event log for the entire system-wide set of log events (VPRN and non-VPRN).

```
configure log services-all-events
```

7.4 Customizing syslog messages using Python



Note: The Python 3 pySROS modules (except `pysros.syslog`) are not available for use during syslog message customization.



Note: The Python syslog customization feature does not support SR OS filesystem access from Python.

Log events in SR OS can be customized, including by a Python script, before they are sent to a syslog server. If the result of a log filter is to drop the event, no further processing occurs and the message is not sent. The following figure shows the interaction between the logger and the Python engine.

Figure 22: Interaction between the logger and the Python engine

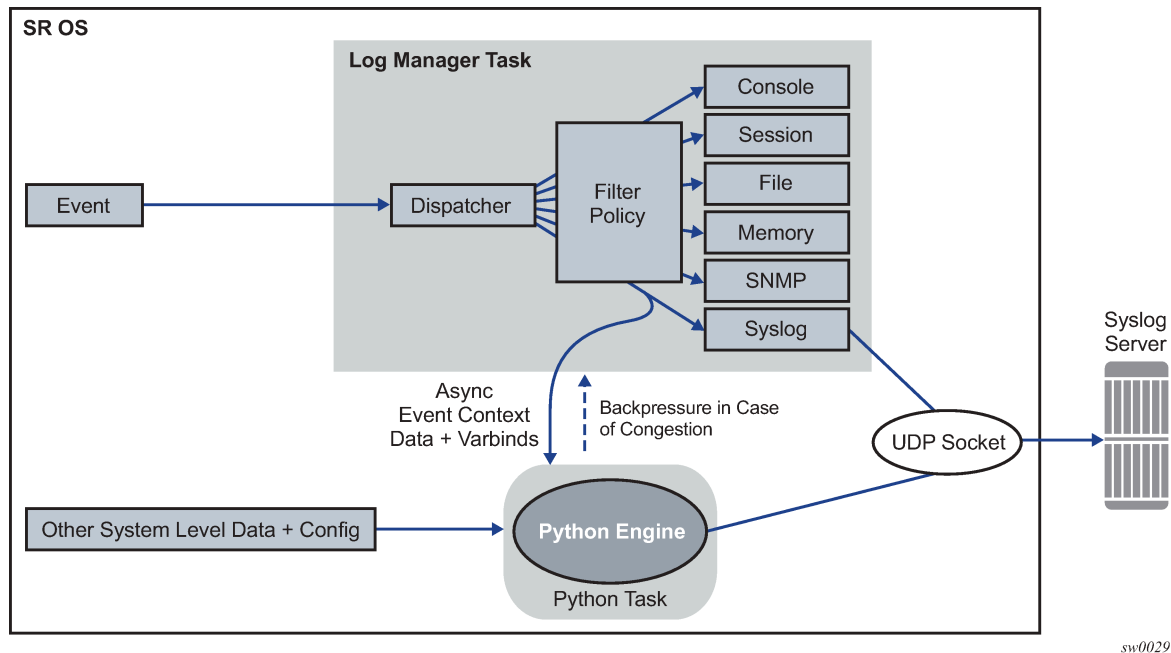

7.4.1 Python engine for syslog

This section describes the syslog-specific aspects of Python processing. For an introduction to Python, see the *7450 ESS, 7750 SR, and VSR Triple Play Service Delivery Architecture Guide, "Python script support for ESM"*.

When an event is dispatched to the log manager in SR OS, the log manager asynchronously passes the event context data and variables (varbinds in Python 2 and event parameters in Python 3) to the Python engine; that is, the logger task is not waiting for feedback from Python.

Varbinds or event parameters are variable bindings that represent the variable number of values that are included in the event. Each varbind in Python 2 consists of a triplet (OID, type, value).

Along with other system-level variables, the Python engine constructs a syslog message and sends it to the syslog destination when the Python engine successfully concludes. During this process, the operator can modify the format of the syslog message or leave it intact, as if it was generated by the syslog process within the log manager.

The tasks of the Python engine in a syslog context are as follows:

- assemble custom syslog messages (including PRI, HEADER and MSG fields) based on the received event context data, varbinds and event parameters specific to the event, system-level data, and the configuration parameters (syslog server IP address, syslog facility, log-prefix, and the destination UDP port)
- reformat timestamps in a syslog message
- modify attributes in the message and reformats the message
- send the original or modified message to the syslog server
- drop the message

7.4.1.1 Python 2 syslog APIs

Python APIs are used to assemble a syslog message which, in SR OS, has the format described in section [Syslog](#).

The following table describes Python information that can be used to manipulate syslog messages.

Table 43: Manipulating Python syslog messages

| Imported Nokia (ALC) modules | Access rights | Comments |
|---|---------------|---|
| event (from alc import event) | — | Method used to retrieve generic event information |
| syslog (from alc import syslog) | — | Method used to retrieve syslog-specific parameters |
| system (from alc import system) | — | Method used to retrieve system-specific information. Currently, the only parameter retrieved is the system name. |
| <p>Events use the following format as they are written into memory, file, console, and system: nnnn <time> <severity>:<application> # <event_id> <router-name> <subject> <message></p> <p>The event-related information received in the context data from the log manager is retrieved via the following Python methods:</p> | | |
| event.sequence | RO | Sequence number of the event (nnnn) |
| event.timestamp | RO | Event timestamp in the format: (YYYY/MM/DD HH:MM:SS.SS) |
| event.routerName | RO | Router name, for example, BASE, VPRN1, and so on |
| event.application | RO | Application generating the event, for example, NA |
| event.severity | RO | Event severity configurable in SR OS (CLEARED [1], INFO [2], CRITICAL [3], MAJOR [4], MINOR [5], WARNING [6]). |
| event.eventId | RO | Event ID; for example, 2012 |
| event.eventName | RO | Event Name; for example, tmnxNatPIBlocl AllocationLsn |
| event.subject | RO | Optional field; for example, [NAT] |
| event.message | RO | Event-specific message; for example, "{2} Map 192.168.20.29 [2001-2005] MDA 1/ 2 -- 276824064 classic-lsn-sub %3 vprn1 10.10.10.101 at 2015/08/31 09:20:15" |

| Imported Nokia (ALC) modules | Access rights | Comments |
|---------------------------------------|---------------|--|
| Syslog methods | | |
| syslog.hostName | RO | IP address of the SR OS node sending the syslog message. This is used in the Syslog HEADER. |
| syslog.logPrefix | RO | Log prefix which is configurable and optional; for example, TMNX: |
| syslog.severityToPRI(event.severity) | — | Python method used to derive the PRI field in syslog header based on event severity and a configurable syslog facility |
| syslog.severityToName(event.severity) | — | SR OS event severity to syslog severity name. For more information, see the Syslog section. |
| syslog.timestampToUnix(timestamp) | — | Python method that takes a timestamp in the YYYY/MM/DD HH:MM:SS format and converts it into a UNIX-based format (seconds from Jan 01 1970 – UTC) |
| syslog.set(newSyslogPdu) | — | Python method used to send the syslog message in the newSyslogPdu. This variable must be constructed manually via string manipulation. In the absence of the command, the SR OS assembles the default syslog message (as if Python was not configured) and sends it to the syslog server, assuming that the message is not explicitly dropped. |
| syslog.drop() | — | Python method used to drop a syslog message. This method must be called before the syslog.set<newSyslogPdu method. |
| System methods | | |
| system.name | RO | Python method used to retrieve the system name |

For example, assume that the syslog format is:

```
<PRI><timestamp> <hostname> <log-prefix>: <sequence> <router-name> <appid>-
<severity>-<name>-<eventid> [<subject>]: <text>
```

Then the syslogPdu is constructed via Python as shown in the following example:

```
syslogPdu = "<" + syslog.severityToPRI(event.severity) + ">" \
+ event.timestamp + " " \
+ syslog.hostname + " " + syslog.logPrefix + ": " + \
event.sequence + " " + event.routerName + " " + \
event.application + "-" + \
syslog.severityToName(event.severity) + "-" + \
event.eventName + "-" + event.eventId + " [" + \
event.subject + "]: " + event.message
```

7.4.1.2 Python 3 syslog APIs

Python APIs are used to modify and assemble a syslog message which, in SR OS, has the format described in section [Syslog](#).

The syslog module for Python 3 is included in the pySROS libraries pre-installed on the SR OS device. The **get_event** function must be imported from the **pysros.syslog** module at the beginning of each Python 3 application by including the following:

```
from pysros.syslog import get_event
```

The specific event that the syslog handler is processing can be returned in a variable using the following example Python 3 code:

```
my_event = get_event()
```

In the preceding example, `my_event` is an object of type `Event`. The `Event` class provides a number of parameters and functions as described in the following table:

Table 44: Parameters and functions for the Event class

| Key name | Python type | Read-only | Description |
|--------------------|-------------|-----------|--|
| name | String | N | Event name |
| appid | String | N | Name of application that generated the log message |
| eventid | Integer | N | Event ID number of the application |
| severity | String | N | Severity level of the event (lowercase). The accepted values in SR OS are: <ul style="list-style-type: none"> • none • cleared • indeterminate • critical • major • minor • warning |
| sequence | Integer | N | Sequence number of the event in the syslog collector |
| subject | String | N | Subject or affected object for the event |
| router_name | String | N | Name of the SR OS router-instance (for example, Base) in which the event is triggered |
| gentime | String | Y | Timestamp in ISO 8601 format for the generated event. Example: 2021-03-08T11:52:06.0-0500. |

| Key name | Python type | Read-only | Description |
|----------------------------------|-------------|-----------|---|
| | | | Changes to the timestamp field are reflected in this field |
| timestamp | Float | N | Timestamp, in seconds |
| hostname | String | N | Hostname field of the syslog message. This can be an IP address, a fully-qualified domain name, or a hostname. |
| log_prefix | String | N | Optional log prefix, for example, TMNX |
| facility | Integer | N | Syslog facility [0-31] |
| text | String | N | String representation of the text portion of the message only. By default, this is generated from the eventparameters attribute. |
| eventparameters | Dict | Y | Python class that behaves similarly to a Python dictionary of all key, value pairs for all log event specific information that does not fall into the standard fields. |
| format_msg() | String | n/a | Formatted version of the full log message as it appears in show log  Note: format_msg() is a function itself and must be called to generate the formatted message. |
| format_syslog_msg() | String | n/a | Formatted version of the syslog message as it would be sent to the syslog server.  Note: format_syslog_msg() is a function itself and must be called to generate the formatted message. |
| override_payload(payload) | | n/a | Provide a custom syslog message as it would appear in the packet, including the header information (facility, timestamp, and so on) and body data (the actual message). Attributes from this Event are used to construct a completely new message format. Any prior changes to the values of these attributes are used. |
| drop() | | n/a | Drop the message from the pipeline. The syslog message is not sent out (regardless of any subsequent changes in the Python script). The script continues normally. |

The parameter values for the specific event are provided in the Event class. At the end of the Python application execution, the resultant values are returned to the syslog system to transmit the syslog

message. Any changes made to the read-write parameters are used in the syslog message unless the **drop()** method is called.

More information about the `pysros.syslog` module can be found in the API documentation for pySROS delivered with the pySROS libraries.

7.4.1.3 Timestamp format manipulation in Python 2

Certain logging environments require customized formatting of the timestamp. Nokia provides a timestamp conversion method in the `alu.syslog` Python module to convert a timestamp from the format `YYYY/MM/DD hh:mm:ss` into a UNIX-based timestamp format (seconds from Jan 01 1970 – UTC).

For example, an operator can use the following Python method to convert a timestamp from the `YYYY/MM/DD hh:mm:ss.ss` or `YYYY/MM/DD hh:mm:ss` (no centiseconds) format into either the UNIX timestamp format or the `MMM DD hh:mm:ss` format.

```

from alc import event
from alc import syslog
from alc import system
#input format: YYYY/MM/DD hh:mm:ss.ss or YYYY/MM/DD hh:mm:ss
#output format 1: MMM DD hh:mm:ss
#output format 2: unixTimestamp (TBD)
def timeFormatConversion(timestamp, format):
    if format not in range(1,2):
        raise NameError('Unexpected format, expected: ' \
                        '\0<format<3 got: '+str(format))
    try:
        dat,tim=timestamp.split(' ')
    except:
        raise NameError('Unexpected timestamp format, expected: ' \
                        '\YYYY/MM/DD hh:mm:ss got: '+timestamp)
    try:
        YYYY,MM,DD=dat.split('/')
    except:
        raise NameError('Unexpected timestamp format, expected: ' \
                        '\YYYY/MM/DD hh:mm:ss got: '+timestamp)
    try:
        hh,mm,ss=tim.split(':')
        ss=ss.split('.')[0] #just in case that the time format is hh:mm:ss.ss
    except:
        raise NameError('Unexpected timestamp format, expected: ' \
                        '\YYYY/MM/DD hh:mm:ss got: '+timestamp)
    if not (1970<=int(YYYY)<2100 and
            1<=int(MM)<=12 and
            1<=int(DD)<=31 and
            0<=int(hh)<=24 and
            0<=int(mm)<=60 and
            0<=int(ss)<=60):
        raise NameError('Unexpected timestamp format, or values out of the range' \
                        '\Expected: YYYY/MM/DD hh:mm:ss got: '+timestamp)
    if format == 1:
        MMM={1: 'Jan',
            2: 'Feb',
            3: 'Mar',
            4: 'Apr',
            5: 'May',
            6: 'Jun',
            7: 'Jul',
            8: 'Aug',
            9: 'Sep',
            10: 'Oct',

```

```

    11: 'Nov',
    12: 'Dec'}[int(MM)]
    timestamp=MMM+' '+DD+' '+hh+':'+mm+':'+ss
if format == 2:
    timestamp=syslog.timestampToUnix(timestamp)
return timestamp

```

The `timeFormatConversion` method can accept the `event.timestamp` value in the format:

```
YYYY/MM/DD HH:MM:SS.SS
```

and return a new timestamp in the format determined by the format parameter:

```

1 # MMM DD HH:MM:SS
2 # Unix based time format

```

This method accepts the input format in either of the two forms, `YYYY/MM/DD HH:MM:SS.SS` or `YYYY/MM/DD HH:MM:SS`, and ignores the centisecond part in the former form.

7.4.1.4 Timestamp format manipulation in Python 3

Certain logging environments require customized formatting of the timestamp. The Python 3 interpreter provided with SR OS also provides the `utime` and `datetime` modules for format manipulation.

7.4.2 Python processing efficiency

Python retrieves event-related variables from the log manager, as opposed to retrieving pre-assembled syslog messages. This eliminates the need for string parsing of the syslog message to manipulate its constituent parts increasing the speed of Python processing.

To further improve processing performance, Nokia recommends performing string manipulation via the Python native string method, when possible.

7.4.3 Python backpressure

A Python task assembles syslog messages based on the context information received from the logger and sends them to the syslog server independent of the logger. If the Python task is congested because of a high volume of received data, the backpressure should be sent to the ISA so that the ISA stops allocating NAT resources. This behavior matches the current behavior in which NAT resources allocation is blocked if that logger is congested.

7.4.4 Selecting events for Python processing

About this task

Events destined for Python processing are configured through a log ID that references a Python policy. Event selection is performed using a filter associated with the log ID. The remainder of the events destined for the same syslog server can bypass Python processing by redirecting them to a different log ID.

Procedure

Step 1. Use the commands in the following contexts to create the Python policy and log ID:

- **MD-CLI**

```
configure python python-policy PyForLogEvents
configure python python-policy syslog
```

- **classic CLI**

```
configure python python-policy PyForLogEvents create
configure python python-policy syslog
```

Step 2. Use log filters to identify the events that are subject to Python processing:

Example

MD-CLI

```
[ex:/configure log]
A:admin@node-2# info
  filter "6" {
    default-action drop
    named-entry "1" {
      action forward
      match {
        application {
          eq nat
        }
        event {
          eq 2012
        }
      }
    }
  }
}
filter "7" {
  default-action forward
  named-entry "1" {
    action drop
    match {
      application {
        eq nat
      }
      event {
        eq 2012
      }
    }
  }
}
}
```

Example

classic CLI

```
A:node-2>config>log# info
-----
  filter 6
    default-action drop
    entry 1
      action forward
      match
        application eq "nat"
```

```

        number eq 2012
    exit
exit
filter 7
    default-action forward
    entry 1
        action drop
        match
            application eq "nat"
            number eq 2012
    exit
exit
exit

```

Step 3. Specify the syslog destination.

Example

MD-CLI

```

[ex:/configure log]
A:admin@node-2# info
    syslog "1" {
        address 192.168.1.1
    }

```

Example

classic CLI

```

A:node-2>config>log># info
-----
    syslog 1
        address 192.168.1.1
    exit

```

Step 4. Apply the Python syslog policy to selected events using the specified filters.

In the following example, the configuration-only event 2012 from application "nat" is sent to log-id 33. All other events are forwarded to the same syslog destination using log-id 34, without any modification. As a result, all events (modified using log-id 33 and unmodified using log-id 34) are sent to the syslog 1 destination.

This configuration may cause reordering of syslog messages at the syslog 1 destination because of slight delay of messages processed by Python.

Example

MD-CLI

```

[ex:/configure log]
A:admin@node-2# info
    log-id "33" {
        admin-state enable
        python-policy "PyForLogEvents"
        filter "6"
        source {
            main true
        }
        destination {
            syslog "1"
        }
    }

```



```

log-id "34" {
  admin-state enable
  filter "7"
  source {
    main true
  }
  destination {
    syslog "1"
  }
}

```

Example classic CLI

```

A:node-2>config>log># info
-----
log-id 33
  filter 6
  from main
  to syslog 1
  python-policy "PyForLogEvents"
  no shutdown
exit
log-id 34
  filter 7
  from main
  to syslog 1
  no shutdown
exit

```

7.5 Accounting logs

Before an accounting policy can be created, a target log file policy must be created to collect the accounting records. The files are stored in system memory on compact flash (cf1: or cf2:) in a compressed (tar) XML format and can be retrieved using FTP or SCP.

A file policy can only be assigned to either one event log or one accounting log.

7.5.1 Accounting records

An accounting policy must define a record name and collection interval. Only one record name can be configured per accounting policy. Also, a record name can only be used in one accounting policy.

The record name, sub-record types, and default collection period for service and network accounting policies are shown in [Table 45: Accounting record name and collection periods](#), [Table 47: Policer stats field descriptions](#) (fields per policer stat-mode are provided in the **stat-mode** command descriptions in the *7450 ESS, 7750 SR, 7950 XRS, and VSR Quality of Service Guide*), [Table 48: Queue group record types](#), and [Table 49: Queue group record type fields](#) provide field descriptions.

Table 45: Accounting record name and collection periods

| Record name | Sub-record types | Accounting object | Platform | Default collection period (minutes) |
|------------------------------------|--|-----------------------------|----------|-------------------------------------|
| service-ingress-octets | sio | SAP | All | 5 |
| service-egress-octets | seo | SAP | All | 5 |
| service-ingress-packets | sip | SAP | All | 5 |
| service-egress-packets | sep | SAP | All | 5 |
| network-ingress-octets | nio | Network port | All | 15 |
| network-egress-octets | neo | Network port | All | 15 |
| network-egress-packets | nep | Network port | All | 15 |
| network-ingress-packets | nio | Network port | All | 15 |
| compact-service-ingress-octets | ctSio | SAP | All | 5 |
| combined-service-ingress | cmSipo | SAP | All | 5 |
| combined-network-ing-egr-octets | cmNio & cmNeo | Network port | All | 15 |
| combined-service-ing-egr-octets | cmSio & cmSeo | SAP | All | 5 |
| complete-network-ingr-egr | cpNipo & cpNepo | Network port | All | 15 |
| complete-service-ingress-egress | cpSipo & cpSepo | SAP | All | 5 |
| combined-sdp-ingress-egress | cmSdpipo and cm Sdpepo | SDP and SDP binding | All | 5 |
| complete-sdp-ingress-egress | cmSdpipo, cm Sdpepo, cpSdpipo and cpSdpepo | SDP and SDP binding | All | 5 |
| complete-subscriber-ingress-egress | cpSBipo & cpSBepo | Subscriber profile | 7750 SR | 5 |
| aa-protocol | aaProt | AA ISA Group | 7750 SR | 15 |
| aa-application | aaApp | AA ISA Group | 7750 SR | 15 |
| aa-app-group | aaAppGrp | AA ISA Group | 7750 SR | 15 |
| aa-subscriber-protocol | aaSubProt | Special study AA subscriber | 7750 SR | 15 |

| Record name | Sub-record types | Accounting object | Platform | Default collection period (minutes) |
|---------------------------|------------------|-----------------------------|----------|-------------------------------------|
| aa-subscriber-application | aaSubApp | Special study AA subscriber | 7750 SR | 15 |
| custom-record-aa-sub | aaSubCustom | AA subscriber | All | 15 |
| combined-mpls-lsp-egress | mplsLspEgr | LSP | All | 5 |
| combined-mpls-lsp-ingress | mplsLspIn | LSP | All | 5 |
| saa | saa png trc hop | SAA or SAA test | All | 5 |
| complete-ethernet-port | enet | Ethernet port | All | 15 |

When creating accounting policies, one service accounting policy and one network accounting policy can be defined as default. If statistics collection is enabled on a SAP or network port and no accounting policy is applied, then the respective default policy is used. If no default policy is defined, then no statistics are collected unless a specifically defined accounting policy is applied.

Each accounting record name is composed of one or more sub-records which is in turn composed of multiple fields.

See the Application Assurance Statistics Fields Generated per Record table in the *7450 ESS, 7750 SR, and VSR Multiservice ISA and ESA Guide* for fields names for Application Assurance records.

The availability of the records listed in [Table 46: Accounting record name details](#) depends on the specific platform functionality and user configuration.

Table 46: Accounting record name details

| Record name | Sub-record | Field | Field description |
|------------------------------|------------|-----------|--|
| Service-ingress-octets (sio) | sio | svc | SvclD |
| | | sap | SapId |
| | | host-port | Associated satellite host port ID (optional) ¹⁴ |
| | | qid | QueueId |
| | | hoo | OfferedHiPrioOctets |
| | | hod | DroppedHiPrioOctets |
| | | loo | LowOctetsOffered |
| | | lod | LowOctetsDropped |

¹⁴ The host-port field is only included if the SAP is bound to an Ethernet satellite client port or a LAG with satellite client ports.

| Record name | Sub-record | Field | Field description |
|---|------------|-----------|--|
| | | uco | UncoloredOctetsOffered |
| | | iof | InProfileOctetsForwarded |
| | | oof | OutOfProfileOctetsForwarded |
| Service-egress-octets (seo) | seo | svc | SvcId |
| | | sap | SapId |
| | | host-port | Associated satellite host port ID (optional) ¹⁴ |
| | | qid | QueueId |
| | | iof | InProfileOctetsForwarded |
| | | iod | InProfileOctetsDropped |
| | | oof | OutOfProfileOctetsForwarded |
| | | ood | OutOfProfileOctetsDropped |
| Service-ingress-packets (sip) ¹⁵ | sip | svc | SvcId |
| | | sap | SapId |
| | | host-port | Associated satellite host port ID (optional) ¹⁴ |
| | | qid | QueueId |
| | | hpo | HighPktsOffered |
| | | hpd | HighPktsDropped |
| | | lpo | LowPktsOffered |
| | | lpd | LowPktsDropped |
| | | ucp | UncoloredPacketsOffered |
| | | ipf | InProfilePktsForwarded |
| | | opf | OutOfProfilePktsForwarded |
| Service-egress-packets (sep) ¹⁵ | sep | svc | SvcId |
| | | sap | SapId |

¹⁵ For a SAP in AAL5 SDU mode, packet counters refer to the number of SDU. For a SAP in N-to-1 cell mode, packet counters refer to the number of cells.

| Record name | Sub-record | Field | Field description |
|-------------------------------|------------|-----------|--|
| | | host-port | Associated satellite host port ID (optional) ¹⁴ |
| | | qid | QueueId |
| | | ipf | InProfilePktsForwarded |
| | | ipd | InProfilePktsDropped |
| | | opf | OutOfProfilePktsForwarded |
| | | opd | OutOfProfilePktsDropped |
| Network-ingress-octets (nio) | nio | port | PortId |
| | | qid | QueueId |
| | | iof | InProfileOctetsForwarded |
| | | iod | InProfileOctetsDropped |
| | | oof | OutOfProfileOctetsForwarded |
| | | ood | OutOfProfileOctetsDropped |
| Network-egress-octets (neo) | neo | port | PortId |
| | | qid | QueueId |
| | | iof | InProfileOctetsForwarded |
| | | iod | InProfileOctetsDropped |
| | | oof | OutOfProfileOctetsForwarded |
| | | ood | OutOfProfileOctetsDropped |
| Network-ingress-packets (nip) | nip | port | PortId |
| | | qid | QueueId |
| | | ipf | InProfilePktsForwarded |
| | | ipd | InProfilePktsDropped |
| | | opf | OutOfProfilePktsForwarded |
| | | opd | OutOfProfilePktsDropped |
| Network-egress-packets (nep) | nep | port | PortId |
| | | qid | QueueId |
| | | ipf | InProfilePktsForwarded |

| Record name | Sub-record | Field | Field description |
|--|-----------------------------|-------|---------------------------|
| | | ipd | InProfilePktsDropped |
| | | opf | OutOfProfilePktsForwarded |
| | | opd | OutOfProfilePktsDropped |
| Compact-service-ingress-octets (ctSio) | ctSio | svc | SvcId |
| | | sap | SapId |
| | | qid | QueueId |
| | | hoo | OfferedHiPrioOctets |
| | | hod | DroppedHiPrioOctets |
| | | loo | LowOctetsOffered |
| | | lod | LowOctetsDropped |
| | | uco | UncoloredOctetsOffered |
| Combined-service-ingress (cmSipo) | cmSipo | svc | SvcId |
| | | sap | SapId |
| | | qid | QueueId |
| | | hpo | HighPktsOffered |
| | | hpd | HighPktsDropped |
| | | lpo | LowPktsOffered |
| | | lpd | LowPktsDropped |
| | | ucp | UncoloredPacketsOffered |
| | | hoo | OfferedHiPrioOctets |
| | | hod | DroppedHiPrioOctets |
| | | loo | LowOctetsOffered |
| | | lod | LowOctetsDropped |
| | | uco | UncoloredOctetsOffered |
| | | ipf | InProfilePktsForwarded |
| | | opf | OutOfProfilePktsForwarded |
| | | iof | InProfileOctetsForwarded |
| oof | OutOfProfileOctetsForwarded | | |

| Record name | Sub-record | Field | Field description |
|--|------------|-------|-----------------------------|
| Combined-network-ing-egr-octets (cmNio & cmNeo) | cmNio | port | PortId |
| | | qid | QueueId |
| | | iof | InProfileOctetsForwarded |
| | | iod | InProfileOctetsDropped |
| | | oof | OutOfProfileOctetsForwarded |
| | | ood | OutOfProfileOctetsDropped |
| | cmNeo | port | PortId |
| | | qid | QueueId |
| | | iof | InProfileOctetsForwarded |
| | | iod | InProfileOctetsDropped |
| | | oof | OutOfProfileOctetsForwarded |
| | | ood | OutOfProfileOctetsDropped |
| Combined-service-ingr-egr-octets (cmSio & CmSeo) | cmSio | svc | SvcId |
| | | sap | SapId |
| | | qid | QueueId |
| | | hoo | OfferedHiPrioOctets |
| | | hod | DroppedHiPrioOctets |
| | | loo | LowOctetsOffered |
| | | lod | LowOctetsDropped |
| | | uco | UncoloredOctetsOffered |
| | | iof | InProfileOctetsForwarded |
| | | oof | OutOfProfileOctetsForwarded |
| | cmSeo | svc | SvcId |
| | | sap | SapId |
| | | qid | QueueId |
| | | iof | InProfileOctetsForwarded |
| | | iod | InProfileOctetsDropped |
| | | oof | OutOfProfileOctetsForwarded |

| Record name | Sub-record | Field | Field description |
|---|------------|-------|-----------------------------|
| | | ood | OutOfProfileOctetsDropped |
| Complete-network-ingr-egr (cpNipo & cpNepo) | cpNipo | port | PortId |
| | | qid | QueueId |
| | | ipf | InProfilePktsForwarded |
| | | ipd | InProfilePktsDropped |
| | | opf | OutOfProfilePktsForwarded |
| | | opd | OutOfProfilePktsDropped |
| | | iof | InProfileOctetsForwarded |
| | | iod | InProfileOctetsDropped |
| | | oof | OutOfProfileOctetsForwarded |
| | | ood | OutOfProfileOctetsDropped |
| | cpNepo | port | PortId |
| | | qid | QueueId |
| | | ipf | InProfilePktsForwarded |
| | | ipd | InProfilePktsDropped |
| | | opf | OutOfProfilePktsForwarded |
| | | opd | OutOfProfilePktsDropped |
| | | iof | InProfileOctetsForwarded |
| | | iod | InProfileOctetsDropped |
| | | oof | OutOfProfileOctetsForwarded |
| | | ood | OutOfProfileOctetsDropped |
| Complete-service-ingress-egress (cpSipo & cpSepo) | cpSipo | svc | SvcId |
| | | sap | SapId |
| | | qid | QueueId |
| | | hpo | HighPktsOffered |
| | | hpd | HighPktsDropped |
| | | lpo | LowPktsOffered |
| | | lpd | LowPktsDropped |

| Record name | Sub-record | Field | Field description |
|--|-----------------------|-------|------------------------------|
| | | ucp | UncoloredPacketsOffered |
| | | hoo | OfferedHiPrioOctets |
| | | hod | DroppedHiPrioOctets |
| | | loo | LowOctetsOffered |
| | | lod | LowOctetsDropped |
| | | uco | UncoloredOctetsOffered |
| | | apo | AllPacketsOffered |
| | | aoo | AllOctetsOffered |
| | | apd | AllPacketsDropped |
| | | aod | AllOctetsDropped |
| | | apf | AllPacketsForwarded |
| | | aof | AllOctetsForwarded |
| | | ipd | InProfilePktsDropped |
| | | iod | InProfileOctetsDropped |
| | | opd | OutOfProfilePktsDropped |
| | | ood | OutOfProfileOctetsDropped |
| | | hpf | HighPriorityPacketsForwarded |
| | | hof | HighPriorityOctetsForwarded |
| Complete-service-ingress-egress (cp Sipo & cpSepo) (Continued) | cpSipo (Continued) | lpf | LowPriorityPacketsForwarded |
| | | lof | LowPriorityOctesForwarded |
| | | ipf | InProfilePktsForwarded |
| | | opf | OutOfProfilePktsForwarded |
| | | iof | InProfileOctetsForwarded |
| | | oof | OutOfProfileOctetsForwarded |
| | cpSepo | svc | SvcId |
| | | sap | SapId |
| | | qid | QueueId |
| | | ipf | InProfilePktsForwarded |

| Record name | Sub-record | Field | Field description |
|--|------------|--------------------|-----------------------------|
| | | ipd | InProfilePktsDropped |
| | | opf | OutOfProfilePktsForwarded |
| | | opd | OutOfProfilePktsDropped |
| | | iof | InProfileOctetsForwarded |
| | | iod | InProfileOctetsDropped |
| | | oof | OutOfProfileOctetsForwarded |
| | | ood | OutOfProfileOctetsDropped |
| Complete-sdp-ingress-egress (cp Sdpipo & cpSdpepo) | cpSdpipo | sdp | SdpID |
| | | tpf | TotalPacketsForwarded |
| | | tpd | TotalPacketsDropped |
| | | tof | TotalOctetsForwarded |
| | | tod | TotalOctetsDropped |
| | cpSdpepo | sdp | SdpID |
| | | tpd | TotalPacketsDropped |
| tod | | TotalOctetsDropped | |
| Combined-sdp-ingress-egress (cm Sdpipo & cmSdpepo) | cmSdpipo | svc | SvcID |
| | | sdp | SdpID |
| | | tpf | TotalPacketsForwarded |
| | | tpd | TotalPacketsDropped |
| | | tof | TotalOctetsForwarded |
| | | tod | TotalOctetsDropped |
| | cmSdpepo | svc | SvcID |
| | | sdp | SdpID |
| | | tpf | TotalPacketsForwarded |
| | | tof | TotalOctetsForwarded |
| Complete-sdp-ingress-egress (cm Sdpipo & cmsdpepo) (cpSdpip & cp Sdpepo) | cmSdpipo | svc | SvcID |
| | | sdp | SdpID |
| | | tpf | TotalPacketsForwarded |

| Record name | Sub-record | Field | Field description |
|---|--|------------|---------------------------------|
| | | tpd | TotalPacketsDropped |
| | | tof | TotalOctetsForwarded |
| | | tod | TotalOctetsDropped |
| | cmSdpepo | svc | SvcID |
| | | sdp | SdpID |
| | | tpf | TotalPacketsForwarded |
| | | tof | TotalOctetsForwarded |
| | cpSdpipo | sdp | SdpID |
| | | tpf | TotalPacketsForwarded |
| | | tpd | TotalPacketsDropped |
| | | tof | TotalOctetsForwarded |
| | | tod | TotalOctetsDropped |
| | cpSdpepo | sdp | SdpID |
| | | tpf | TotalPacketsForwarded |
| | | tof | TotalOctetsForwarded |
| Complete-subscriber-ingress-egress (cpSBipo & cpSBepo) | Subscriber Information | subId | SubscriberId |
| | | subProfile | SubscriberProfile |
| | Sla- Information | svc | SvcId |
| | | sap | SapId |
| | | slaProfile | SlaProfile |
| | | spiSharing | SPI sharing type and identifier |
| | Complete-subscriber-ingress-egress (cpSBipo & cpSBepo) (Continued) | cpSBipo | qid |
| hpo | | | HighPktsOffered |
| hpd | | | HighPktsDropped |
| lpo | | | LowPktsOffered |
| lpd | | | LowPktsDropped |
| ucp | | | UncolouredPacketsOffered |
| hoo | | | OfferedHiPrioOctets |

| Record name | Sub-record | Field | Field description |
|--|------------|-------|-----------------------------|
| | | hod | DroppedHiPrioOctets |
| | | loo | LowOctetsOffered |
| | | lod | LowOctetsDropped |
| | | apo | AllPktsOffered |
| | | aoo | AllOctetsOffered |
| | | uco | UncolouredOctetsOffered |
| | | ipf | InProfilePktsForwarded |
| | | opf | OutOfProfilePktsForwarded |
| | | iof | InProfileOctetsForwarded |
| | | oof | OutOfProfileOctetsForwarded |
| | | v4pf | IPv4PktsForwarded |
| | | v6pf | IPv6PktsForwarded |
| | | v4pd | IPv4PktsDropped |
| | | v6pd | IPv6PktsDropped |
| | | v4of | IPv4OctetsForwarded |
| | | v6of | IPv6OctetsForwarded |
| | | v4od | IPv4OctetsDropped |
| | | v6od | IPv6OctetsDropped |
| Complete-subscriber-ingress-egress (cpSBipo & cpSBepo) (Continued) | cpSBepo | qid | QueueId |
| | | ipf | InProfilePktsForwarded |
| | | ipd | InProfilePktsDropped |
| | | opf | OutOfProfilePktsForwarded |
| | | opd | OutOfProfilePktsDropped |
| | | iof | InProfileOctetsForwarded |
| | | iod | InProfileOctetsDropped |
| | | oof | OutOfProfileOctetsForwarded |
| | | ood | OutOfProfileOctetsDropped |
| | | v4pf | IPv4PktsForwarded |

| Record name | Sub-record | Field | Field description |
|-------------|------------|-------|---------------------|
| | | v6pf | IPv6PktsForwarded |
| | | v4pd | IPv4PktsDropped |
| | | v6pd | IPv6PktsDropped |
| | | v4of | IPv4OctetsForwarded |
| | | v6of | IPv6OctetsForwarded |
| | | v4od | IPv4OctetsDropped |
| | | v6od | IPv6OctetsDropped |
| saa | saa | tmd | TestMode |
| | | own | OwnerName |
| | | tst | TestName |
| | | png | PingRun subrecord |
| | | rid | RunIndex |
| | | trr | TestRunResult |
| | | mnr | MinRtt |
| | | mrx | MaxRtt |
| | | avr | AverageRtt |
| | | rss | RttSumOfSquares |
| | | pbr | ProbeResponses |
| | | spb | SentProbes |
| | | mnt | MinOutTt |
| | | mxt | MaxOutTt |
| | | avt | AverageOutTt |
| | | tss | OutTtSumOfSquares |
| | | mni | MinInTt |
| | | mxi | MaxInTt |
| | | avi | AverageInTt |
| | | iss | InTtSumOfSqrs |
| | | ojt | OutJitter |

| Record name | Sub-record | Field | Field description |
|-----------------|------------|-------|-------------------|
| | | ijt | InJitter |
| | | rjt | RtJitter |
| | | prt | ProbeTimeouts |
| | | prf | ProbeFailures |
| saa (Continued) | trc | rid | RunIndex |
| | | trr | TestRunResult |
| | | lgp | LastGoodProbe |
| | hop | hop | TraceHop |
| | | hid | HopIndex |
| | | mnr | MinRtt |
| | | mxr | MaxRtt |
| | | avr | AverageRtt |
| | | rss | RttSumOfSquares |
| | | pbr | ProbeResponses |
| | | spb | SentProbes |
| | | mnt | MinOutTt |
| | | mxt | MaxOutTt |
| | | avt | AverageOutTt |
| | | tss | OutTtSumOfSquares |
| | | mni | MinInTt |
| | | mxi | MaxInTt |
| | | avi | AverageInTt |
| | | iss | InTtSumOfSqrs |
| | | ojt | OutJitter |
| | | ijt | InJitter |
| | | rjt | RtJitter |
| | | prt | ProbeTimeouts |
| | | prf | ProbeFailures |

| Record name | Sub-record | Field | Field description |
|-------------------------------|--------------------------------|---------|----------------------------------|
| | | tat | TraceAddressType |
| | | tav | TraceAddressValue |
| Complete-ethernet-port (enet) | enet | port | PortId |
| | | to | EtherStatsOctets |
| | | tp | EtherStatsPkts |
| | | de | EtherStatsDropEvents |
| | | tbcp | EtherStatsBroadcastPkts |
| | | mcp | EtherStatsMulticastPkts |
| | | cae | EtherStatsCRCAlignErrors |
| | | up | EtherStatsUndersizePkts |
| | | op | EtherStatsOversizePkts |
| | | fgm | EtherStatsFragments |
| | | jab | EtherStatsJabbers |
| | | col | EtherStatsCollisions |
| | | p64o | EtherStatsPkts64Octets |
| | | p127o | EtherStatsPkts65to127Octets |
| | | p255o | EtherStatsPkts128to255Octets |
| | | p511o | EtherStatsPkts256to511Octets |
| | | p1023o | EtherStatsPkts512to1023Octets |
| | | p1518o | EtherStatsPkts1024to1518Octets |
| | | po1518o | EtherStatsPktsOver1518Octets |
| | | ae | Dot3StatsAlignmentErrors |
| | | fe | Dot3StatsFCSErrors |
| | | scf | Dot3StatsSingleCollisionFrames |
| | | mcf | Dot3StatsMultipleCollisionFrames |
| sqe | Dot3StatsSQETestErrors | | |
| dt | Dot3StatsDeferredTransmissions | | |

| Record name | Sub-record | Field | Field description |
|--|------------------|-------|-------------------------------------|
| Complete-ethernet-port (enet) (Continued) | enet (Continued) | lcc | Dot3StatsLateCollisions |
| | | exc | Dot3StatsExcessiveCollisions |
| | | imt | Dot3StatsInternalMacTransmit Errors |
| | | cse | Dot3StatsCarrierSenseErrors |
| | | ftl | Dot3StatsFrameTooLongs |
| | | imre | Dot3StatsInternalMacReceive Errors |
| | | se | Dot3StatsSymbolErrors |
| | | ipf | Dot3InPauseFrames |
| | | opf | Dot3OutPauseFrames |

Table 47: Policer stats field descriptions, Table 48: Queue group record types, and Table 49: Queue group record type fields provide field descriptions.

Table 47: Policer stats field descriptions

| Field | Field description |
|----------|--|
| pid | PolicerId |
| statmode | PolicerStatMode |
| aod | AllOctetsDropped |
| aof | AllOctetsForwarded |
| aoo | AllOctetsOffered |
| apd | AllPacketsDropped |
| apf | AllPacketsForwarded |
| apo | AllPacketsOffered |
| c1od | ConnectionOneOctetsDropped ¹⁶ |
| c1of | ConnectionOneOctetsForwarded ¹⁶ |
| c1oo | ConnectionOneOctetsOffered ¹⁶ |
| c1pd | ConnectionOnePacketsDropped ¹⁶ |

¹⁶ Enhanced Subscriber Management (ESM) connection bonding only

| Field | Field description |
|-------|---|
| c1pf | ConnectionOnePacketsForwarded ¹⁶ |
| c1po | ConnectionOnePacketsOffered ¹⁶ |
| c2od | ConnectionTwoOctetsDropped ¹⁶ |
| c2of | ConnectionTwoOctetsForwarded ¹⁶ |
| c2oo | ConnectionTwoOctetsOffered ¹⁶ |
| c2pd | ConnectionTwoPacketsDropped ¹⁶ |
| c2pf | ConnectionTwoPacketsForwarded ¹⁶ |
| c2po | ConnectionTwoPacketsOffered ¹⁶ |
| hod | HighPriorityOctetsDropped |
| hof | HighPriorityOctetsForwarded |
| hoo | HighPriorityOctetsOffered |
| hpd | HighPriorityPacketsDropped |
| hpf | HighPriorityPacketsForwarded |
| hpo | HighPriorityPacketsOffered |
| iod | InProfileOctetsDropped |
| iof | InProfileOctetsForwarded |
| ioo | InProfileOctetsOffered |
| ipd | InProfilePacketsDropped |
| ipf | InProfilePacketsForwarded |
| ipo | InProfilePacketsOffered |
| lod | LowPriorityOctetsDropped |
| lof | LowPriorityOctetsForwarded |
| loo | LowPriorityOctetsOffered |
| lpd | LowPriorityPacketsDropped |
| lpf | LowPriorityPacketsForwarded |
| lpo | LowPriorityPacketsOffered |

| Field | Field description |
|-------|---------------------------------|
| opd | OutOfProfilePacketsDropped |
| opf | OutOfProfilePacketsForwarded |
| opo | OutOfProfilePacketsOffered |
| ood | OutOfProfileOctetsDropped |
| oof | OutOfProfileOctetsForwarded |
| ooo | OutOfProfileOctetsOffered |
| xpd | ExceedProfilePktsDropped |
| xpf | ExceedProfilePktsForwarded |
| xpo | ExceedProfilePktsOffered |
| xod | ExceedProfileOctetsDropped |
| xof | ExceedProfileOctetsForwarded |
| xoo | ExceedProfileOctetsOffered |
| ppd | InplusProfilePacketsDropped |
| ppf | InplusProfilePacketsForwarded |
| ppo | InplusProfilePacketsOffered |
| pod | InplusProfileOctetsDropped |
| pof | InplusProfileOctetsForwarded |
| poo | InplusProfileOctetsOffered |
| uco | UncoloredOctetsOffered |
| ucp | UncoloredPacketsOffered |
| v4po | IPv4PktsOffered ¹⁷ |
| v4oo | IPv4OctetsOffered ¹⁷ |
| v6po | IPv6PktsOffered ¹⁷ |
| v6oo | IPv6OctetsOffered ¹⁷ |
| v4pf | IPv4PktsForwarded ¹⁷ |
| v6pf | IPv6PktsForwarded ¹⁷ |

¹⁷ Enhanced Subscriber Management (ESM) only

| Field | Field description |
|-------|-----------------------------------|
| v4pd | IPv4PktsDropped ¹⁷ |
| v6pd | IPv6PktsDropped ¹⁷ |
| v4of | IPv4OctetsForwarded ¹⁷ |
| v6of | IPv6OctetsForwarded ¹⁷ |
| v4od | IPv4OctetsDropped ¹⁷ |
| v6od | IPv6OctetsDropped ¹⁷ |

Table 48: Queue group record types

| Record name | Description |
|-------------|--|
| qgone | PortQueueGroupOctetsNetworkEgress |
| qgosi | PortQueueGroupOctetsServiceIngress |
| qgose | PortQueueGroupOctetsServiceEgress |
| qgpne | PortQueueGroupPacketsNetworkEgress |
| qgpsi | PortQueueGroupPacketsServiceIngress |
| qgpse | PortQueueGroupPacketsServiceEgress |
| fpqgosi | ForwardingPlaneQueueGroupOctetsServiceIngress |
| fpqgoni | ForwardingPlaneQueueGroupOctetsNetworkIngress |
| fpqgpsi | ForwardingPlaneQueueGroupPacketsServiceIngress |
| fpqgpni | ForwardingPlaneQueueGroupPacketsNetworkIngress |

Table 49: Queue group record type fields

| Field | Field description |
|------------------|--|
| data port | Port (used for port based Queue Groups) |
| member-port | LAGMemberPort (used for port based Queue Groups) |
| data slot | Slot (used for Forwarding Plane based Queue Groups) |
| forwarding-plane | ForwardingPlane (used for Forwarding Plane based Queue Groups) |
| queue-group | QueueGroupName |
| instance | QueueGroupInstance |

| Field | Field description |
|-----------|-------------------|
| qid | QueueId |
| pid | PolicerId |
| statmode | PolicerStatMode |
| aod...ucp | same as above |

7.5.2 Accounting files

When a policy is created and applied to a service or network port, the accounting file is stored on the compact flash in a compressed XML file format. The router creates two directories on the compact flash to store the files.

Example

The following output displays a directory named `\act-collect` that holds open accounting files that are actively collecting statistics. The directory named `\act` stores the files that have been closed and are awaiting retrieval.

```
A:node-2>file cf1:\# dir act*
12/19/2006 06:08a    <DIR>      act-collect
12/19/2006 06:08a    <DIR>      act

A:node-2>file cf1:\act-collect\ # dir
Directory of cf1:\act-collect#

12/23/2006 01:46a    <DIR>      .
12/23/2006 12:47a    <DIR>      ..
12/23/2006 01:46a                112 act1111-20031223-014658.xml.gz
12/23/2006 01:38a                197 act1212-20031223-013800.xml.gz
```

Accounting files always have the prefix "act" followed by the accounting policy ID, log ID, and timestamp. For detailed information about the accounting log file naming and log file policy properties such as rollover and retention, see [Log and accounting files](#).

7.5.3 Design considerations for accounting policies

The router has ample resources to support large scale accounting policy deployments. When preparing for an accounting policy deployment, verify that data collection, file rollover, and file retention intervals are properly tuned for the amount of statistics to be collected.

If the accounting policy collection interval is too brief there may be insufficient time to store the data from all the services within the specified interval. If that is the case, some records may be lost or incomplete. Interval time, record types, and number of services using an accounting policy are all factors that should be considered when implementing accounting policies.

The rollover and retention intervals on the log files and the frequency of file retrieval must also be considered when designing accounting policy deployments. The amount of data stored depends on the type of record collected, the number of services that are collecting statistics, and the collection interval that is used. For example, with a 1Gb CF and using the default collection interval, the system is expected to hold 48 hours' worth of billing information.

7.5.4 Reporting and time-based accounting

SR OS on the 7750 SR platform has support for volume accounting and time-based accounting concepts, and provides an extra level of intelligence at the network element level to provide service models such as "prepaid access" in a scalable manner. This means that the network element gathers and stores per-subscriber accounting information and compares it with "pre-defined" quotas. When a quota is exceeded, the pre-defined action (such as re-direction to a web portal or disconnect) is applied.

7.5.5 Custom record usage for overhead reduction in accounting

Custom records can be used to decrease accounting messaging overhead as follows:

- [User configurable records](#)
- [Changed statistics only](#)
- [Configurable accounting records](#)
- [Significant change only reporting](#)

7.5.5.1 User configurable records

Users can define a collection of fields that make up a record. These records can be assigned to an accounting policy. These are user-defined records instead of being limited to pre-defined record types. The operator can select queues and policers and the counters within these queues and policers that need to be collected. See the predefined records containing a specific field for XML field name of a custom record field.

7.5.5.2 Changed statistics only

A record is only generated if a significant change has occurred to the fields being written in a specific record. This capability applies to both ingress and egress records regardless on the method of delivery (such as RADIUS and XML). The capability also applies to Application Assurance records; however without an ability to specify different significant change values and per-field scope (for example, all fields of a custom record are collected if any activity was reported against any of the statistics that are part of the custom record).

7.5.5.3 Configurable accounting records

7.5.5.3.1 XML accounting files for service and ESM-based accounting

To reduce the volume of data generated, you can specify which records are needed for collection. This excludes queues and policers or selected counters within the queues and policers that are not relevant for billing.

Use the commands in the following context to configure custom records.

```
configure log accounting-policy custom-record
```

ESM-based accounting applies to the 7750 SR only.

Record headers including information such as service ID or SAP ID are always generated.

7.5.5.3.2 XML accounting files for policer counters

Policer counters can be collected using custom records within the accounting policy configuration. The policer identifier for which counters are collected must be configured under **custom-record**, specifying the required ingress (**i-counters**) and egress (**e-counters**) counters to be collected. A similar configuration is available for a reference policer (**ref-policer**) to define a reference counter used together with the **significant-change** command.

The counters collected are dependent on the **stat-mode** of the related policer, as this determines which statistics are collected by the system for the policer.

The ingress policer counters collected for each combination of XML accounting record name and policer **stat-mode** are provided in [Table 50: Custom record policer ingress counter mapping](#).

The egress policer counters collected for each combination of XML accounting record name and policer **stat-mode** are provided in [Table 51: Custom record policer egress counter mapping](#).

Table 50: Custom record policer ingress counter mapping

| Policer i-counters CLI name | Policer stat-mode | Custom record counter | Custom record field |
|-----------------------------------|-----------------------------|------------------------------|---------------------|
| in-profile-octets-discarded-count | minimal | — | — |
| | offered-limited-capped-cir | In-Profile Octets Dropped | iod |
| | offered-limited-profile-cir | | |
| | offered-priority-cir | | |
| | offered-profile-capped-cir | | |
| offered-profile-cir | | | |
| offered-profile-no-cir | | | |
| offered-total-cir | | | |
| in-profile-octets-forwarded-count | offered-priority-no-cir | High-Priority Octets Dropped | hod |
| | v4-v6 | V4 Octets Dropped | v4od |
| | minimal | — | — |
| | offered-limited-capped-cir | In-Profile Octets Forwarded | iof |
| offered-limited-profile-cir | | | |
| offered-priority-cir | | | |
| offered-profile-capped-cir | | | |
| offered-profile-cir | | | |
| offered-profile-no-cir | | | |

| Policer i-counters CLI name | Policer stat-mode | Custom record counter | Custom record field |
|------------------------------------|---|--------------------------------|---------------------|
| | offered-total-cir | | |
| | offered-priority-no-cir | High-Priority Octets Forwarded | hof |
| | v4-v6 | V4 Octets Forwarded | v4of |
| in-profile-octets-offered-count | minimal offered-limited-profile-cir offered-total-cir | — | — |
| | offered-limited-capped-cir offered-profile-capped-cir offered-profile-cir offered-profile-no-cir | In-Profile Octets Offered | ioo |
| | offered-priority-cir offered-priority-no-cir | High-Priority Octets Offered | hoo |
| | v4-v6 | V4 Octets Offered | v4oo |
| | | | |
| in-profile-packets-discarded-count | minimal | — | — |
| | offered-limited-capped-cir offered-limited-profile-cir offered-priority-cir offered-profile-capped-cir offered-profile-cir offered-profile-no-cir offered-total-cir | In-Profile Packets Dropped | ipd |
| | offered-priority-no-cir | High-Priority Packets Dropped | hpd |
| | v4-v6 | V4 Packets Dropped | v4pd |
| in-profile-packets-forwarded-count | minimal | — | — |
| | offered-limited-capped-cir offered-limited-profile-cir offered-priority-cir offered-profile-capped-cir offered-profile-cir offered-profile-no-cir | In-Profile Packets Forwarded | ipf |

| Policer i-counters CLI name | Policer stat-mode | Custom record counter | Custom record field |
|------------------------------------|---|---------------------------------|---------------------|
| | offered-total-cir | | |
| | offered-priority-no-cir | High-Priority Packets Forwarded | hpf |
| | v4-v6 | V4 Packets Forwarded | v4pf |
| in-profile-packets-offered-count | minimal offered-limited-profile-cir offered-total-cir | — | — |
| | offered-limited-capped-cir offered-profile-capped-cir offered-profile-cir offered-profile-no-cir | In-Profile Packets Offered | ipo |
| | offered-priority-cir offered-priority-no-cir | High-Priority Packets Offered | hpo |
| | v4-v6 | V4 Packets Offered | v4po |
| | | | |
| out-profile-octets-discarded-count | minimal | All Octets Dropped | aod |
| | offered-limited-capped-cir offered-limited-profile-cir offered-priority-cir offered-profile-capped-cir offered-profile-cir offered-profile-no-cir offered-total-cir | Out-of-Profile Octets Dropped | ood |
| | offered-priority-no-cir | Low-Priority Octets Dropped | lod |
| | v4-v6 | V6 Octets Dropped | v6od |
| out-profile-octets-forwarded-count | minimal | All Octets Forwarded | aof |
| | offered-limited-capped-cir offered-limited-profile-cir offered-priority-cir offered-profile-capped-cir offered-profile-cir offered-profile-no-cir | Out-of-Profile Octets Forwarded | oof |

| Policer i-counters CLI name | Policer stat-mode | Custom record counter | Custom record field |
|-------------------------------------|------------------------------|----------------------------------|----------------------------|
| | offered-total-cir | | |
| | offered-priority-no-cir | Low-Priority Octets Forwarded | lof |
| | v4-v6 | V6 Octets Forwarded | v6of |
| out-profile-octets-offered-count | minimal | All Octets Offered | ao |
| | offered-total-cir | | |
| | offered-limited-capped-cir | — | — |
| | offered-limited-profile-cir | Out-of-Profile Octets Offered | ooo |
| | offered-profile-capped-cir | | |
| | offered-profile-cir | | |
| | offered-profile-no-cir | | |
| offered-priority-cir | Low-Priority Octets Offered | loo | |
| offered-priority-no-cir | | | |
| v4-v6 | V6 Octets Offered | v6oo | |
| out-profile-packets-discarded-count | minimal | All Packets Dropped | apd |
| | offered-limited-capped-cir | Out-of-Profile Packets Dropped | opd |
| | offered-limited-profile-cir | | |
| | offered-priority-cir | | |
| | offered-profile-capped-cir | | |
| | offered-profile-cir | | |
| | offered-profile-no-cir | | |
| | offered-total-cir | | |
| offered-priority-no-cir | Low-Priority Packets Dropped | lpd | |
| v4-v6 | V6 Packets Dropped | v6pd | |
| out-profile-packets-forwarded-count | minimal | All Packets Forwarded | apf |
| | offered-limited-capped-cir | Out-of-Profile Packets Forwarded | opf |
| | offered-limited-profile-cir | | |
| | offered-priority-cir | | |
| | offered-profile-capped-cir | | |
| | offered-profile-cir | | |
| offered-profile-no-cir | | | |

| Policer i-counters CLI name | Policer stat-mode | Custom record counter | Custom record field |
|--|--|--|---------------------|
| | offered-total-cir | | |
| | offered-priority-no-cir | Low-Priority Packets Forwarded | lpf |
| | v4-v6 | V6 Packets Forwarded | v6pf |
| out-profile-packets-offered-count | minimal offered-total-cir | All Packets Offered | apo |
| | offered-limited-capped-cir | n/a | n/a |
| | offered-limited-profile-cir offered-profile-capped-cir offered-profile-cir offered-profile-no-cir | Out-of-Profile Packets Offered | opo |
| | offered-priority-cir offered-priority-no-cir | Low-Priority Packets Offered | lpo |
| | v4-v6 | V6 Packets Offered | v6po |
| | uncoloured-octets-offered-count | minimal offered-priority-cir offered-priority-no-cir offered-profile-no-cir offered-total-cir v4-v6 | — |
| offered-limited-capped-cir offered-limited-profile-cir offered-profile-capped-cir offered-profile-cir | | Uncoloured Octets Offered | uco |
| uncoloured-packets-offered-count | minimal offered-priority-cir offered-priority-no-cir offered-profile-no-cir offered-total-cir v4-v6 | — | — |
| | offered-limited-capped-cir offered-limited-profile-cir | Uncoloured Packets Offered | ucp |

| Policer i-counters CLI name | Policer stat-mode | Custom record counter | Custom record field |
|-----------------------------|---|-----------------------|---------------------|
| | offered-profile-capped-cir offered-profile-cir | | |

Table 51: Custom record policer egress counter mapping

| Policer e-counters CLI name | Policer stat-mode | Custom record counter | Custom record field |
|---------------------------------------|---|---------------------------------|---------------------|
| exceed-profile-octets-discarded-count | bonding minimal offered-limited-capped-cir offered-profile-capped-cir offered-profile-cir offered-profile-no-cir offered-total-cir v4-v6 | n/a | n/a |
| | offered-four-profile-no-cir offered-total-cir-exceed offered-total-cir-four-profile | Exceed-Profile Octets Dropped | xod |
| exceed-profile-octets-forwarded-count | bonding minimal offered-limited-capped-cir offered-profile-capped-cir offered-profile-cir offered-profile-no-cir offered-total-cir v4-v6 | — | — |
| | offered-four-profile-no-cir offered-total-cir-exceed offered-total-cir-four-profile | Exceed-Profile Octets Forwarded | xof |
| exceed-profile-octets-offered-count | bonding minimal offered-limited-capped-cir offered-profile-capped-cir | — | — |

| Policer e-counters CLI name | Policer stat-mode | Custom record counter | Custom record field |
|--|---|----------------------------------|---------------------|
| | offered-profile-cir offered-profile-no-cir offered-total-cir offered-total-cir-exceed offered-total-cir-four-profile v4-v6 | | |
| | offered-four-profile-no-cir | Exceed-Profile Octets Offered | xoo |
| exceed-profile-packets-discarded-count | bonding minimal offered-limited-capped-cir offered-profile-capped-cir offered-profile-cir offered-profile-no-cir offered-total-cir v4-v6 | — | — |
| | offered-four-profile-no-cir offered-total-cir-exceed offered-total-cir-four-profile | Exceed-Profile Packets Dropped | xpd |
| exceed-profile-packets-forwarded-count | bonding minimal offered-limited-capped-cir offered-profile-capped-cir offered-profile-cir offered-profile-no-cir offered-total-cir v4-v6 | — | — |
| | offered-four-profile-no-cir offered-total-cir-exceed offered-total-cir-four-profile | Exceed-Profile Packets Forwarded | xpf |
| exceed-profile-packets-offered-count | bonding minimal offered-limited-capped-cir | — | — |

| Policer e-counters CLI name | Policer stat-mode | Custom record counter | Custom record field |
|--|---|----------------------------------|---------------------|
| | offered-profile-capped-cir offered-profile-cir offered-profile-no-cir offered-total-cir offered-total-cir-exceed offered-total-cir-four-profile v4-v6 | | |
| | offered-four-profile-no-cir | Exceed-Profile Packets Offered | xpo |
| in-plus-profile-octets-discarded-count | bonding minimal offered-limited-capped-cir offered-profile-capped-cir offered-profile-cir offered-profile-no-cir offered-total-cir offered-total-cir-exceed v4-v6 | — | — |
| | offered-four-profile-no-cir offered-total-cir-four-profile | In-Plus-Profile Octets Dropped | pod |
| in-plus-profile-octets-forwarded-count | bonding minimal offered-limited-capped-cir offered-profile-capped-cir offered-profile-cir offered-profile-no-cir offered-total-cir offered-total-cir-exceed v4-v6 | — | — |
| | offered-four-profile-no-cir offered-total-cir-four-profile | In-Plus-Profile Octets Forwarded | pof |
| in-plus-profile-octets-offered-count | bonding minimal | — | — |

| Policer e-counters CLI name | Policer stat-mode | Custom record counter | Custom record field |
|---|---|-----------------------------------|---------------------|
| | offered-limited-capped-cir offered-profile-capped-cir offered-profile-cir offered-profile-no-cir offered-total-cir offered-total-cir-exceed offered-total-cir-four-profile v4-v6 | | |
| | offered-four-profile-no-cir | In-Plus-Profile Octets Offered | poo |
| in-plus-profile-packets-discarded-count | bonding minimal offered-limited-capped-cir offered-profile-capped-cir offered-profile-cir offered-profile-no-cir offered-total-cir offered-total-cir-exceed v4-v6 | — | — |
| | offered-four-profile-no-cir offered-total-cir-four-profile | In-Plus-Profile Packets Dropped | ppd |
| in-plus-profile-packets-forwarded-count | bonding minimal offered-limited-capped-cir offered-profile-capped-cir offered-profile-cir offered-profile-no-cir offered-total-cir offered-total-cir-exceed v4-v6 | — | — |
| | offered-four-profile-no-cir offered-total-cir-four-profile | In-Plus-Profile Packets Forwarded | ppf |
| in-plus-profile-packets-offered-count | bonding | — | — |

| Policer e-counters CLI name | Policer stat-mode | Custom record counter | Custom record field |
|-----------------------------------|---|---------------------------------|---------------------|
| | minimal offered-limited-capped-cir offered-profile-capped-cir offered-profile-cir offered-profile-no-cir offered-total-cir offered-total-cir-exceed offered-total-cir-four-profile v4-v6 | | |
| | offered-four-profile-no-cir | In-Plus-Profile Packets Offered | ppo |
| in-profile-octets-discarded-count | bonding | Connection 1 Octets Dropped | c1od |
| | minimal | — | — |
| | offered-four-profile-no-cir offered-limited-capped-cir offered-profile-capped-cir offered-profile-cir offered-profile-no-cir offered-total-cir offered-total-cir-exceed offered-total-cir-four-profile | In-Profile Octets Dropped | iod |
| | v4-v6 | V4 Octets Dropped | v4od |
| in-profile-octets-forwarded-count | bonding | Connection 1 Octets Forwarded | c1of |
| | minimal | — | — |
| | offered-limited-capped-cir offered-profile-capped-cir offered-profile-cir offered-profile-no-cir offered-total-cir offered-total-cir-exceed offered-four-profile-no-cir offered-total-cir-four-profile | In-Profile Octets Forwarded | iof |

| Policer e-counters CLI name | Policer stat-mode | Custom record counter | Custom record field |
|------------------------------------|---|--------------------------------|---------------------|
| | v4-v6 | V4 Octets Forwarded | v4of |
| in-profile-octets-offered-count | bonding | Connection 1 Octets Offered | c1oo |
| | minimal | — | — |
| | offered-total-cir offered-total-cir-exceed offered-total-cir-four-profile | | |
| | offered-four-profile-no-cir offered-limited-capped-cir offered-profile-capped-cir offered-profile-cir offered-profile-no-cir | In-Profile Octets Offered | ioo |
| | v4-v6 | V4 Octets Offered | v4oo |
| in-profile-packets-discarded-count | bonding | Connection 1 Packets Dropped | c1pd |
| | minimal | — | — |
| | offered-four-profile-no-cir offered-limited-capped-cir offered-profile-capped-cir offered-profile-cir offered-profile-no-cir offered-total-cir offered-total-cir-exceed offered-total-cir-four-profile | In-Profile Packets Dropped | ipd |
| | v4-v6 | V4 Packets Dropped | v4pd |
| in-profile-packets-forwarded-count | bonding | Connection 1 Packets Forwarded | c1pf |
| | minimal | — | — |
| | offered-limited-capped-cir offered-profile-capped-cir offered-profile-cir offered-profile-no-cir offered-total-cir offered-total-cir-exceed | In-Profile Packets Forwarded | ipf |
| | | | |

| Policer e-counters CLI name | Policer stat-mode | Custom record counter | Custom record field |
|------------------------------------|---|---------------------------------|-----------------------------|
| | offered-four-profile-no-cir offered-total-cir-four-profile | | |
| | v4-v6 | V4 Packets Forwarded | v4pf |
| in-profile-packets-offered-count | bonding | Connection 1 Packets Offered | c1po |
| | minimal offered-total-cir offered-total-cir-exceed offered-total-cir-four-profile | — | — |
| | offered-four-profile-no-cir offered-limited-capped-cir offered-profile-capped-cir offered-profile-cir offered-profile-no-cir | In-Profile Packets Offered | ipo |
| | v4-v6 | V4 Packets Offered | v4po |
| | out-profile-octets-discarded-count | bonding | Connection 2 Octets Dropped |
| | minimal | All Octets Dropped | aod |
| | offered-limited-capped-cir offered-profile-capped-cir offered-profile-cir offered-profile-no-cir offered-total-cir offered-total-cir-exceed offered-four-profile-no-cir offered-total-cir-four-profile | Out-of-Profile Octets Dropped | ood |
| | v4-v6 | V6 Octets Dropped | v6od |
| out-profile-octets-forwarded-count | bonding | Connection 2 Octets Forwarded | c2of |
| | minimal | All Octets Forwarded | aof |
| | offered-limited-capped-cir offered-profile-capped-cir offered-profile-cir offered-profile-no-cir | Out-of-Profile Octets Forwarded | oof |
| | | | |

| Policer e-counters CLI name | Policer stat-mode | Custom record counter | Custom record field |
|-------------------------------------|---|----------------------------------|---------------------|
| | offered-total-cir offered-total-cir-exceed offered-four-profile-no-cir offered-total-cir-four-profile | | |
| | v4-v6 | V6 Octets Forwarded | v6of |
| out-profile-octets-offered-count | bonding | Connection 2 Octets Offered | c2oo |
| | minimal offered-total-cir offered-total-cir-exceed offered-total-cir-four-profile | All Octets Offered | aoo |
| | offered-limited-capped-cir offered-profile-capped-cir offered-profile-cir offered-profile-no-cir offered-four-profile-no-cir | Out-of-Profile Octets Offered | ooo |
| | v4-v6 | V6 Octets Offered | v6oo |
| out-profile-packets-discarded-count | bonding | Connection 2 Packets Dropped | c2pd |
| | minimal | All Packets Dropped | apd |
| | offered-limited-capped-cir offered-profile-capped-cir offered-profile-cir offered-profile-no-cir offered-total-cir offered-total-cir-exceed offered-four-profile-no-cir offered-total-cir-four-profile | Out-of-Profile Packets Dropped | opd |
| | v4-v6 | V6 Packets Dropped | v6pd |
| out-profile-packets-forwarded-count | bonding | Connection 2 Packets Forwarded | c2pf |
| | minimal | All Packets Forwarded | apf |
| | offered-limited-capped-cir offered-profile-capped-cir | Out-of-Profile Packets Forwarded | opf |

| Policer e-counters CLI name | Policer stat-mode | Custom record counter | Custom record field |
|-----------------------------------|---|--------------------------------|---------------------|
| | offered-profile-cir offered-profile-no-cir offered-total-cir offered-total-cir-exceed offered-four-profile-no-cir offered-total-cir-four-profile | | |
| | v4-v6 | V6 Packets Forwarded | v6pf |
| out-profile-packets-offered-count | bonding | Connection 2 Packets Offered | c2po |
| | minimal offered-total-cir offered-total-cir-exceed offered-total-cir-four-profile | All Packets Offered | apo |
| | offered-limited-capped-cir offered-profile-capped-cir offered-profile-cir offered-profile-no-cir offered-four-profile-no-cir | Out-of-Profile Packets Offered | opo |
| | v4-v6 | V6 Packets Offered | v6po |
| uncoloured-octets-offered-count | bonding minimal offered-four-profile-no-cir offered-limited-capped-cir offered-profile-no-cir offered-total-cir offered-total-cir-exceed offered-total-cir-four-profile v4-v6 | — | — |
| | offered-profile-capped-cir offered-profile-cir | Uncoloured Octets Offered | uco |
| uncoloured-packets-offered-count | bonding minimal offered-four-profile-no-cir | — | — |

| Policer e-counters CLI name | Policer stat-mode | Custom record counter | Custom record field |
|-----------------------------|--|----------------------------|---------------------|
| | offered-limited-capped-cir offered-profile-no-cir offered-total-cir offered-total-cir-exceed offered-total-cir-four-profile v4-v6 | | |
| | offered-profile-capped-cir offered-profile-cir | Uncoloured Packets Offered | ucp |

7.5.5.3.3 RADIUS accounting in networks using ESM

You can include individual counters in RADIUS accounting messages. Use the commands in the following context to configure custom-record counters for RADIUS accounting messages.

```
configure subscriber-mgmt radius-accounting-policy custom-record
```

See the CLI help or the reference guide for the commands and syntax. This functionality applies to the 7750 SR only.

7.5.5.4 Significant change only reporting

Another way to decrease accounting messaging related to overhead is to include only "active" objects in a periodical reporting. An "active object" in this context is an object which has seen a "significant" change in corresponding counters. A significant change is defined in terms of a cumulative value (the sum of all reference counters).

This concept is applicable to all methods used for gathering accounting information, such as an XML file and RADIUS, as well as to all applications using accounting, such as service-acct, ESM-acct, and Application Assurance.

Accounting records are reported at the periodical intervals. This periodic reporting is extended with an internal filter which omits periodical updates for objects whose counter change experienced lower changes than a defined (configurable) threshold.

Specific to RADIUS accounting the **significant-change** command does not affect ACCT-STOP messages. ACCT-STOP messages are always sent, regardless the amount of change of the corresponding host.

For Application Assurance records, a significant change of 1 in any field of a customized record (send a record if any field changed) is supported. When configured, if any statistic field records activity, an accounting record containing all fields is collected.

7.5.6 Immediate completion of records

7.5.6.1 Record completion for XML accounting

For ESM RADIUS accounting, an accounting stop message is sent when:

- A subscriber/subscriber-host is deleted.
- An SLA profile instance is changed.

A similar concept is also used for XML accounting. In case the accounted object is deleted or changed, the latest information is written in the XML file with a "final" tag indication in the record header. This functionality applies to the 7750 SR only.

7.5.7 AA accounting per forwarding class

This feature allows the operator to report on protocol/application/app-group volume usage per forwarding class by adding a bitmap information representing the observed FC in the XML accounting files. In case the accounted object is deleted or changed, the latest information is written in the XML file with a "final" tag indication in the record header.

7.6 Configuration notes

This section describes logging configuration restrictions.

- A log file policy or log filter policy cannot be deleted if it has been applied to a log.
- File policies, syslog policies, or SNMP trap groups must be configured before they can be applied to a log ID.
- A file policy can only be assigned to either one event log or one accounting policy.
- Accounting policies must be configured in the **configure log** context before they can be applied to a service SAP or service interface, or applied to a network port.
- The SNMP trap ID must be the same as the log ID.

7.7 Configuring logging with CLI

This section provides information to configure logging with the command line interface.

7.7.1 Log configuration overview

Configure logging to save information in a log file or direct the messages to other devices. Logging does the following:

- Provides you with logging information for monitoring and troubleshooting.
- Allows the selection of the types of logging information to be recorded.
- Allows the assignment of a severity to the log messages.

- Allows the selection of source and target of logging information.

7.7.2 Log types

Logs can be configured in the following contexts:

- **log file**

Log files can contain log event message streams or accounting/billing information. Log file policies are used to direct events, alarms, traps, and debug information to a file on local storage devices (for example, cf2:).

- **SNMP trap groups**

SNMP trap groups contain an IP address and community names which identify targets to send traps following specified events.

- **syslog**

Information can be sent to a syslog host that is capable of receiving selected syslog messages from a network element.

- **event control**

Configures a particular event or all events associated with an application to be generated or suppressed.

- **event filters**

An event filter defines whether to forward or drop an event or trap based on match criteria.

- **accounting policies**

An accounting policy defines the accounting records that will be created. Accounting policies can be applied to one or more service access points (SAPs).

- **event logs**

An event log defines the types of events to be delivered to its associated destination.

- **event throttling rate**

Defines the rate of throttling events.

7.7.3 Basic log configuration

The most basic log configuration must have the following:

- log ID or accounting policy ID
- log source
- log destination

The following example displays a log configuration for the 7750 SR.

Example: MD-CLI

```
[ex:/configure log]
A:admin@node-2# info
  log-events {
    bgp event sendNotification {
```

```

        severity critical
        throttle false
    }
}
file "1" {
    description "This is a test file-id."
    compact-flash-location {
        primary cfl
    }
}
file "2" {
    description "This is a test log."
    compact-flash-location {
        primary cfl
    }
}
log-id "2" {
    source {
        main true
    }
    destination {
        file "2"
    }
}
snmp-trap-group "7" {
    trap-target "testTarget" {
        address 11.22.33.44
        version snmpv2c
        notify-community "public"
    }
}
}

```

Example: classic CLI

```

A:node-2>config>log# info
#-----
echo "Log Configuration "
#-----
    event-control "bgp" 2005 generate critical
    file-id 1
        description "This is a test file-id."
        location cfl:
    exit
    file-id 2
        description "This is a test log."
        location cfl:
    exit
    snmp-trap-group 7
        trap-target "testTarget" address 11.22.33.44 "snmpv2c" notify-community
"public"
    exit
    log-id 2
        from main
        to file 2
    exit
#-----

```

7.7.4 Common configuration tasks

The following sections describe basic system tasks that must be performed.

7.7.4.1 Configuring an event log

A log file policy contains information used to direct events, alarms, traps, and debug information to a file on a local storage device (for example, cf2:). One or more event sources can be specified. File policies, SNMP trap groups, or syslog policies must be configured before they can be applied to an event log.

Use commands in the following context to configure an event log file.

```
configure log log-id
```

The following example shows an event log file configuration.

Example: MD-CLI

```
[ex:/configure log]
A:admin@node-2# info
  log-id "2" {
    description "This is a test log file."
    filter "1"
    source {
      main true
      security true
    }
    destination {
      file "1"
    }
  }
}
```

Example: classic CLI

```
A:node-2>config>log>log-id# info
-----
...
log-id name "2"
  description "This is a test log file."
  filter 1
  from main security
  to file 1
exit
...
-----
```

7.7.4.2 Configuring a log file policy

To create a log file, a file policy is defined, the target CF or USB drive is specified, and the rollover and retention interval period for the log file is defined. The rollover interval is defined in minutes and determines how long a file is used before it is closed and a new log file is created. The retention interval determines how long the file is stored on the CF before it is deleted.

When creating new log files in a compact flash disk card, the minimum amount of free space is the minimum of 10% of Compact Flash disk capacity or 5 Mb (5,242,880 = 5 × 1024 × 1024).

The following example shows a log file configuration.

Example: MD-CLI

```

ex:/configure log]
A:admin@node-2# info
  file "1" {
    description "This is a log file."
    rollover 600
    retention 24
    compact-flash-location {
      primary cf1
    }
  }

```

Example: classic CLI

```

A:ALA-12>config>log# info
-----
  file-id name "1"
    description "This is a log file."
    location cf1:
    rollover 600 retention 24
  exit
-----

```

7.7.4.3 Configuring an accounting policy

A log file policy must be created to collect the accounting records. The files are stored in system memory of compact flash (cf1: or cf2:) in a compressed (tar) XML format and can be retrieved using FTP or SCP. See [Configuring an event log](#) and [Configuring a log file policy](#).

Accounting policies must be configured in the **configure log** context before they can be applied to a service SAP or service interface, or applied to a network port.

The default accounting policy statement cannot be applied to LDP nor RSVP statistics collection records.

An accounting policy must define a record type and collection interval. Only one record type can be configured per accounting policy.

When creating accounting policies, one service accounting policy and one network accounting policy can be defined as default. If statistics collection is enabled on a SAP or network port and no accounting policy is applied, then the respective default policy is used. If no default policy is defined, then no statistics are collected unless a specifically defined accounting policy is applied.

By default, the subscriber host volume accounting data is based on the 14-byte Ethernet DLC header, 4-byte or 8-byte VLAN Tag (optional), 20-byte IP header, IP payload, and the 4-byte CRC (everything except the preamble and inter-frame gap). See [Figure 23: Subscriber host volume accounting data](#). This default can be altered by the **packet-byte-offset** configuration option.

Figure 23: Subscriber host volume accounting data

| Destination MAC | Source MAC | 802.1Q tag (optional) | 802.1Q tag (optional) | Ethertype (Ethernet II) or length (IEEE 802.3) | Payload | CRC/FCS |
|-----------------|------------|-----------------------|-----------------------|--|----------------|----------|
| 6 octets | 6 octets | (4 octets) | (4 octets) | 2 octets | 46-1500 octets | 4 octets |

0971

The following example shows an accounting policy configuration.

Example: MD-CLI

```
[ex:/configure log]
A:admin@node-2# info
  accounting-policy 4 {
    description "This is the default accounting policy."
    default true
    record complete-service-ingress-egress
    destination {
      file "1"
    }
  }
  accounting-policy 5 {
    description "This is a test accounting policy."
    record service-ingress-packets
    destination {
      file "3"
    }
  }
}
```

Example: classic CLI

```
A:node-2>config>log# info
-----
accounting-policy 4
  description "This is the default accounting policy."
  record complete-service-ingress-egress
  default
  to file 1
exit
accounting-policy 5
  description "This is a test accounting policy."
  record service-ingress-packets
  to file 3
exit
-----
```

7.7.4.4 Configuring an accounting custom record

The following example shows a custom-record configuration.

Example: MD-CLI

```
ex:/configure log accounting-policy 1]
A:admin@node-2# info
  custom-record {
    significant-change 20
    queue 1 {
      e-counters {
        in-profile-octets-discarded-count true
        in-profile-octets-forwarded-count true
        out-profile-octets-discarded-count true
        out-profile-octets-forwarded-count true
      }
      i-counters {
        high-octets-discarded-count true
        in-profile-octets-forwarded-count true
        low-octets-discarded-count true
        out-profile-octets-forwarded-count true
      }
    }
  }
}
```

```

    }
    ref-queue {
        all
        e-counters {
            in-profile-packets-forwarded-count true
            out-profile-packets-forwarded-count true
        }
        i-counters {
            in-profile-packets-forwarded-count true
            out-profile-packets-forwarded-count true
        }
    }
}

```

The following example shows another custom-record configuration.

```

[ex:/configure log accounting-policy 1]
A:admin@node-2# info
custom-record {
    significant-change 1
    aa-specific {
        aa-sub-counters {
            long-duration-flow-count true
            medium-duration-flow-count true
            short-duration-flow-count true
            total-flow-duration true
            total-flows-completed-count true
        }
        from-aa-sub-counters {
            flows-active-count true
            flows-admitted-count true
            flows-denied-count true
            forwarding-class true
            max-throughput-octet-count true
            max-throughput-packet-count true
            max-throughput-timestamp true
            octets-admitted-count true
            octets-denied-count true
            packets-admitted-count true
            packets-denied-count true
        }
        to-aa-sub-counters {
            flows-active-count true
            flows-admitted-count true
            flows-denied-count true
            forwarding-class true
            max-throughput-octet-count true
            max-throughput-packet-count true
            max-throughput-timestamp true
            octets-admitted-count true
            octets-denied-count true
            packets-admitted-count true
            packets-denied-count true
        }
    }
    ref-aa-specific-counter {
        any true
    }
}

```

Example: classic CLI

```

A:node-2>config>log>acct-plcy# info
-----
...
    custom-record
      queue 1
        i-counters
          high-octets-discarded-count
          low-octets-discarded-count
          in-profile-octets-forwarded-count
          out-profile-octets-forwarded-count
        exit
        e-counters
          in-profile-octets-forwarded-count
          in-profile-octets-discarded-count
          out-profile-octets-forwarded-count
          out-profile-octets-discarded-count
        exit
      exit
      significant-change 20
      ref-queue all
        i-counters
          in-profile-packets-forwarded-count
          out-profile-packets-forwarded-count
        exit
        e-counters
          in-profile-packets-forwarded-count
          out-profile-packets-forwarded-count
        exit
      exit
    exit
  ...
-----

```

The following example shows another custom-record configuration.

```

A:node-2>config>log>acct-policy# info
-----
...
    custom-record
      aa-specific
        aa-sub-counters
          short-duration-flow-count
          medium-duration-flow-count
          long-duration-flow-count
          total-flow-duration
          total-flows-completed-count
        exit
        from-aa-sub-counters
          flows-admitted-count
          flows-denied-count
          flows-active-count
          packets-admitted-count
          octets-admitted-count
          packets-denied-count
          octets-denied-count
          max-throughput-octet-count
          max-throughput-packet-count
          max-throughput-timestamp
          forwarding-class
        exit
        to-aa-sub-counters
          flows-admitted-count

```

```

flows-denied-count
flows-active-count
packets-admitted-count
octets-admitted-count
packets-denied-count
octets-denied-count
max-throughput-octet-count
max-throughput-packet-count
max-throughput-timestamp
forwarding-class
    exit
exit
significant-change 1
ref-aa-specific-counter any
...
-----

```

7.7.4.5 Configuring event control

The following example shows an event control configuration.

Example: MD-CLI

```

[ex:/configure log]
A:admin@node-2# info
log-events {
    ospf event tmnx0spfVirtIfStateChange {
        generate false
        throttle false
    }
    ospf event tmnx0spfVirtNbrStateChange {
        severity cleared
        throttle false
    }
    ospf event tmnx0spfLsdbOverflow {
        severity critical
        throttle false
    }
}
throttle-rate {
    limit 500
    interval 10
}

```

Example: classic CLI

```

A:node-2>config>log# info
#-----
echo "Log Configuration"
#-----
    throttle-rate 500 interval 10
    event-control "oam" 2001 generate throttle
    event-control "ospf" 2001 suppress
    event-control "ospf" 2003 generate cleared
    event-control "ospf" 2014 generate critical
..
-----

```

7.7.4.6 Configuring a log filter

The following example shows a log filter configuration.

Example: MD-CLI

```
[ex:/configure log]
A:admin@node-2# info
  file "1" {
    description "This is our log file."
    rollover 600
    retention 24
    compact-flash-location {
      primary cfl
    }
  }
  filter "1" {
    description "This is a sample filter."
    default-action drop
    named-entry "1" {
      action forward
      match {
        application {
          eq mirror
        }
        severity {
          eq critical
        }
      }
    }
  }
}
log-id "2" {
  admin-state disable
  description "This is a test log file."
  filter "1"
  source {
    main true
    security true
  }
  destination {
    file "1"
  }
}
```

Example: classic CLI

```
A:node-2>config>log# info
#-----
echo "Log Configuration "
#-----
  file-id name "1"
  description "This is our log file."
  location cfl:
  rollover 600 retention 24
exit
  filter name "1"
  default-action drop
  description "This is a sample filter."
  entry 1
  action forward
  match
    application eq "mirror"
    severity eq critical
```

```

        exit
    exit
    exit
...
    log-id name "2"
        shutdown
        description "This is a test log file."
        filter 1
        from main security
        to file 1
    exit
...
-----

```

7.7.4.7 Configuring an SNMP trap group

The associated log ID does not have to be configured before a **snmp-trap-group** can be created, however, the **snmp-trap-group** must exist before you can configure the log ID to use it.

The following example shows a basic SNMP trap group configuration.

Example: Basic SNMP trap group configuration (MD-CLI)

```

ex:/configure log]
A:admin@node-2# info
  log-id "2" {
    description "This is a test log file."
    filter "1"
    source {
      main true
      security true
    }
    destination {
      snmp {
      }
    }
  }
}

```

Example: SNMP trap group, log, and interface configuration (MD-CLI)

```

ex:/configure log]
A:admin@node-2# info
  snmp-trap-group "2" {
    trap-target "ops-mon-4" {
      address 10.10.10.104
      version snmpv2c
      notify-community "warnings-12a7"
    }
  }
}

```

Example: Basic SNMP trap group configuration (classic CLI)

```

A:node-2>config>log# info
-----
...
snmp-trap-group 2
  trap-target "ops-mon-4" address 10.10.10.104 snmpv2c notify-community "warnings-12a7"
exit
...

```

```

log-id 2
  description "This is a test log file."
  filter 1
  from main security
  to snmp
exit
...
-----

```

Example: SNMP trap group, log, and interface configuration (classic CLI)

```

A:node-2>config>log# snmp-trap-group 44
A:node-2>config>log>snmp-trap-group# info
-----
  trap-target "xyz-test" address xx.xx.x.x snmpv2c notify-community "xyztesting"
  trap-target "test2" address xx.xx.xx.x snmpv2c notify-community "xyztesting"
-----
A:node-2>config>log>log-id# info
-----
  from main
  to snmp
-----
A:node-2>config>router# interface xyz-test
A:node-2>config>router>if# info
-----
  address xx.xx.xx.x/24
  port 1/1/1
-----

```

7.7.4.7.1 Setting the replay option

The following example shows the **replay** option is set by an SNMP SET request for the trap-target address 10.10.10.3, which is bound to the port ID 1/1/1.

Example: MD-CLI

```

[ex:/configure log snmp-trap-group "44"]
A:admin@node-2# info
  trap-target "test2" {
    address 10.20.20.5
    version snmpv2c
    notify-community "xyztesting"
  }
  trap-target "xyz-test" {
    address 10.10.10.3
    version snmpv2c
    notify-community "xyztesting"
    replay true
  }
}

```

Example: classic CLI

```

A:node-2>config>log>snmp-trap-group 44
A:node-2>config>log>snmp-trap-group# info
-----
trap-target "xyz-test" address 10.10.10.3 snmpv2c notify-community "xyztesting"
replay
trap-target "test2" address 10.20.20.5 snmpv2c notify-community "xyztesting"

```

Use the following command to display the SNMP trap group log in the **configure log snmp-trap-group** context.

```
show log snmp-trap-group 44
```

The following example shows output with the Replay field changed from disabled to enabled.

Output example

```
=====
SNMP Trap Group 44
=====
Description : none
-----
Name       : xyz-test
Address    : 10.10.10.3
Port      : 162
Version   : v2c
Community  : xyztesting
Sec. Level : none
Replay    : enabled
Replay from : n/a
Last replay : never
-----
Name       : test2
Address    : 10.20.20.5
Port      : 162
Version   : v2c
Community  : xyztesting
Sec. Level : none
Replay    : disabled
Replay from : n/a
Last replay : never
=====
```

The following output displays the original log because no events are waiting to be replayed.

Output example

```
=====
Event Log 44
=====
SNMP Log contents [size=100  next event=3819  (wrapped)]

3818 2008/04/22 23:35:39.89 UTC WARNING: SYSTEM #2009 Base IP
"Status of vRtrIfTable: router Base (index 1) interface xyz-test (index 35) changed
administrative state: inService, operational state: inService"

3817 2008/04/22 23:35:39.89 UTC WARNING: SNMP #2005 Base xyz-test
"Interface xyz-test is operational"

3816 2008/04/22 23:35:39.89 UTC WARNING: SNMP #2005 Base 1/1/1
"Interface 1/1/1 is operational"

3815 2008/04/22 23:35:39.71 UTC WARNING: SYSTEM #2009 Base CHASSIS
"Status of Mda 1/1 changed administrative state: inService, operational state:
inService"

3814 2008/04/22 23:35:38.88 UTC MINOR: CHASSIS #2002 Base Mda 1/2
"Class MDA Module : inserted"
```

```
3813 2008/04/22 23:35:38.88 UTC MINOR: CHASSIS #2002 Base Mda 1/1
```

7.7.4.7.2 Disabling the SNMP notification outgoing port

Administratively disabling the port to which a trap-target address is bound removes the route to that trap target from the route table. When the SNMP module receives notification of this event, it marks the trap target as inaccessible and saves the sequence ID of the first SNMP notification that is missed by the trap target.

The following example shows how to disable the port and perform a log event test.

Example: Disable the outgoing port and perform a log event test (MD-CLI)

```
[ex:/configure]
A:admin@node-2# port 1/1/1 admin-state disable

[ex:/configure]
A:admin@node-2# commit

[ex:/configure]
A:admin@node-2# exit
INFO: CLI #2056: Exiting private configuration mode

[/]
A:admin@ node-2# tools perform log test-event
```

Example: Disable the outgoing port and perform a log event test (classic CLI)

```
A:node-2# configure port 1/1/1 shutdown
A:node-2# tools perform log test-event
```

Use the following command to display the SNMP trap group log.

```
show log snmp-trap-group
```

The following output example shows the Replay from field is updated with the sequence ID of the first event that is replayed when the trap-target address is added back to the route table.

Output example: SNMP trap group log

```
=====
SNMP Trap Group 44
=====
Description : none
-----
Name       : xyz-test
Address    : 10.10.10.3
Port      : 162
Version    : v2c
Community  : xyztesting
Sec. Level : none
Replay     : enabled
Replay from : event #3819
Last replay : never
-----
Name       : test2
Address    : 10.20.20.5
```

```

Port      : 162
Version   : v2c
Community : xyztesting
Sec. Level : none
Replay    : disabled
Replay from : n/a
Last replay : never
=====

```

The following example shows event log output with trap targets that are not accessible and waiting for notification replay as well as the sequence ID of the first notification that is replayed.



Note: If there are more missed events than the log size, the replay actually starts from the first available missed event.

Output example: SNMP event log

```

=====
Event Log 44
=====
SNMP Log contents [size=100  next event=3821  (wrapped)]
Cannot send to SNMP target address 10.10.10.3.
Waiting to replay starting from event #3819

3820 2008/04/22 23:41:28.00 UTC INDETERMINATE: LOGGER #2011 Base Event Test
"Test event has been generated with system object identifier tmnxModelSR12Reg.
System description: TiMOS-B-0.0.private both/i386 Nokia 7750 SR Copyright (c)
2000-2016 Nokia. All rights reserved. All use subject to applicable license
agreements. Built on Tue Apr 22 14:41:18 PDT 2008 by test123 in /test123/ws/panos/
main"

3819 2008/04/22 23:41:20.37 UTC WARNING: MC_REDUNDANCY #2022 Base operational state
of peer chan*
"The MC-Ring operational state of peer 2.2.2.2 changed to outOfService."

3818 2008/04/22 23:35:39.89 UTC WARNING: SYSTEM #2009 Base IP
"Status of vRtrIfTable: router Base (index 1) interface xyz-test (index 35) changed
administrative state: inService, operational state: inService"

3823 2008/04/22 23:41:49.82 UTC WARNING: SNMP #2005 Base xyz-test
"Interface xyz-test is operational"

```

7.7.4.7.3 Re-enabling the in-band port

When you re-enable the in-band port to which a trap-target address is bound, the route to that trap target is re-added to the route table. When the SNMP trap module is notified of this event, it resends the notifications that were missed while there was no route to the trap-target address.

Use the following commands to enable a port and perform a log event test:

- **MD-CLI**

```

configure port admin-state enable
tools perform log test-event

```

- **classic CLI**

```

configure port no shutdown

```

```
tools perform log test-event
```

Use the following command to display the SNMP trap group log.

```
show log snmp-trap-group log-id-or-log-name
```

After the notifications are replayed, the Replay from field indicates n/a because there are no more notifications waiting to be replayed and the Last replay field timestamp has been updated.

Output example

```
=====
SNMP Trap Group 44
=====
Description : none
-----
Name       : xyz-test
Address    : 10.10.10.3
Port      : 162
Version   : v2c
Community  : xyztesting
Sec. Level : none
Replay    : enabled
Replay from : n/a
Last replay : 04/22/2008 18:52:36
-----
Name       : test2
Address    : 10.20.20.5
Port      : 162
Version   : v2c
Community  : xyztesting
Sec. Level : none
Replay    : disabled
Replay from : n/a
Last replay : never
=====
```

A display of the event log shows that it is no longer waiting to replay notifications to one or more of its trap target addresses. An event message has been written to the logger that indicates the replay to the trap-target address has happened and displays the notification sequence ID of the first and last replayed notifications.

Output example

```
=====
Event Log 44
=====
SNMP Log contents [size=100 next event=3827 (wrapped)]

3826 2008/04/22 23:42:02.15 UTC MAJOR: LOGGER #2015 Base Log-id 44
"Missed events 3819 to 3825 from Log-id 44 have been resent to SNMP notification
target address 10.10.10.3."

3825 2008/04/22 23:42:02.15 UTC INDETERMINATE: LOGGER #2011 Base Event Test
"Test event has been generated with system object identifier tmnxModelSR12Reg.
System description: TiMOS-B-0.0.private both/i386 Nokia 7750 SR Copyright (c)
2000-2016 Nokia.
All rights reserved. All use subject to applicable license agreements.
Built on Tue Apr 22 14:41:18 PDT 2008 by test123 in /test123/ws/panos/main"

3824 2008/04/22 23:41:49.82 UTC WARNING: SYSTEM #2009 Base IP
```

```
"Status of vRtrIfTable: router Base (index 1) interface xyz-test (index 35) changed
administrative state: inService, operational state: inService"

3823 2008/04/22 23:41:49.82 UTC WARNING: SNMP #2005 Base xyz-test
"Interface xyz-test is operational"
```

7.7.4.8 Configuring a syslog target

A valid syslog ID must exist to send log events to a syslog target host. The following example shows a syslog configuration.

Example: MD-CLI

```
[ex:/configure log]
A:admin@node-2# info
  syslog "1" {
    description "This is a syslog file."
    address 10.10.10.104
    facility user
    severity warning
  }
```

Example: classic CLI

```
A:node-2>config>log# info
-----
...
  syslog "1" name "1"
    description "This is a syslog file."
    address 10.10.10.104
    facility user
    level warning
  exit
...
-----
```

7.7.4.9 Modifying a log file

You can modify the configuration of a log file.

Example: MD-CLI

The following example shows a current log-file configuration.

```
[ex:/configure log]
A:admin@node-2# info
  log-id "2" {
    description "This is a test log file."
    filter "1"
    source {
      main true
      security true
    }
    destination {
      file "1"
    }
  }
```

```
}

```

The following example shows modifications to the log-file configuration.

```
[ex:/configure]
A:admin@node-2# log log-id 2

[ex:/configure log log-id "2"]
A:admin@node-2# description "Chassis log file"

[ex:/configure log log-id "2"]
A:admin@node-2# filter 2

[ex:/configure log log-id "2"]
A:admin@node-2# destination file 2

[ex:/configure log log-id "2"]
A:admin@node-2#
```

The following example shows the results of the modifications to the log-file configuration.

```
[ex:/configure log]
A:admin@node-2# info
  log-id "2" {
    description "Chassis log file."
    filter "2"
    source {
      security true
    }
    destination {
      file "2"
    }
  }
}
```

Example: classic CLI

The following example shows a current log-file configuration.

```
A:node-2>config>log>log-id# info
-----
...
log-id name "2"
      description "This is a test log file."
      filter 1
      from main security
      to file 1

exit
...
-----
```

The following example shows modifications to the log-file configuration.

```
*A:node-2>config# log
*A:node-2>config>log# log-id 2
*A:node-2>config>log>log-id# description "Chassis log file."
*A:node-2>config>log>log-id# filter 2
*A:node-2>config>log>log-id# from security
*A:node-2>config>log>log-id# exit
```

The following example shows the results of the modifications to the log-file configuration.

```
A:node-2>config>log# info
-----
...
log-id name "2"
      description "Chassis log file."
      filter 2
      from security
      to file 1
exit
...
-----
```

7.7.4.10 Deleting a log file

Use the following command to delete a log file:

- **MD-CLI**

It is not necessary to disable the log ID before you delete it. Also, you can use the delete command in any context.

```
delete
```

- **classic CLI**

You must shutdown the log ID before you delete it.

```
configure log log-id shutdown
configure log no log-id 2
```

The following example shows how to delete a log file.

Example: MD-CLI

```
[ex:/configure log log-id "2"]
A:admin@node-2# info
      description "filter "1001"
      destination {
          file "50"
      }

[ex:/configure log]
A:admin@node-2# delete log-id 2
```

Example: classic CLI

```
A:node-2>config>log# info
-----
file-id name "1"
      description "LocationTest."
      location cf1:
      rollover 600 retention 24
      exit
...
log-id name "2"
      description "Chassis log file."
      filter 2
      from security
```

```

        to file 1
exit
...
A:node-2>config>log#
A:node-2>config>log# log-id 2
A:node-2>config>log>log-id# shutdown
A:node-2>config>log>log-id# exit
A:node-2>config>log# no log-id 2

```

7.7.4.11 Modifying a log file ID

You can modify the configuration of the log file ID.

Example: MD-CLI

The following example shows the current log-file configuration.

```

[ex:/configure log]
A:admin@node-2# info
  file "1" {
    description "This is a log file."
    rollover 600
    retention 24
    compact-flash-location {
      primary cf1
    }
  }

```

The following example shows the results of the modifications to the log-file configuration.

```

[ex:/configure log]
A:admin@node-2# info
  file "1" {
    description "LocationTest."
    rollover 2880
    retention 500
    compact-flash-location {
      primary cf2
    }
  }

```

Example: classic CLI

The following example shows the current log-file configuration.

```

A:node-2>config>log# info
-----
  file-id name "1"
    description "This is a log file."
    location cf1:
    rollover 600 retention 24
  exit
-----

```

The following example shows modifications to the log-file configuration.

```

A:node-2>config>log# file-id 1
A:node-2>config>log>file-id# description "LocationTest."
A:node-2>config>log>file-id# location cf2:

```



```
A:node-2>config>log>file-id# rollover 2880 retention 500
A:node-2>config>log>file-id# exit
```

The following example shows the results of the modifications to the log-file configuration.

```
A:node-2>config>log# info
-----
...
file-id name "1"
  description "LocationTest."
  location cf2:
  rollover 2880 retention 500
exit
...
-----
```

7.7.4.12 Modifying a syslog ID

You can modify the syslog ID for a log.

Example: MD CLI

The following example shows modifications to the syslog 1 configuration.

```
*[ex:/configure]
A:admin@node-2# log syslog 1

*[ex:/configure log syslog "1"]
A:admin@node-2# description "Test syslog"

*[ex:/configure log syslog "1"]
A:admin@node-2# address 10.10.0.91
```

The following example shows the results of the modifications to the syslog 1 configuration.

```
[ex:/configure log syslog]
A:admin@node-2# info
...
  syslog "1" {
    description "Test syslog"
    address 10.10.0.91
    facility mail
    severity info
  }
}
```

Example: classic CLI

The following example shows modifications to the syslog 1 configuration.

```
*A:node-2>config>log#
*A:node-2>config>log# syslog 1
*A:node-2>config>log>syslog$ description "Test syslog."
*A:node-2>config>log>syslog# address 10.10.0.91
*A:node-2>config>log>syslog# facility mail
```

The following example shows the results of the modifications to the syslog 1 configuration.

```
A:node-2>config>log# info
-----
...
    syslog name "1"
        description "Test syslog."
        address 10.10.10.91
        facility mail
        level info
    exit
...
-----
```

7.7.4.13 Deleting an SNMP trap group

Use the following commands to delete SNMP trap groups:

- **MD-CLI**

```
configure log snmp-trap-group delete trap-target
configure log delete snmp-trap-group
```

- **classic CLI**

```
configure log snmp-trap-group no trap-target
configure log no snmp-trap-group
```

Example: classic CLI

The following example shows an SNMP trap group configuration.

```
A:node-2>config>log# info
-----
...
    snmp-trap-group name "10"
        trap-target "ops-mon-4" address 10.10.10.104 snmpv2c notify-community
    "warnings-12a7"
    exit
...
-----
```

The following example shows deleting the trap target and SNMP trap group.

```
A:node-2>config>log# snmp-trap-group
A:node-2>config>log>snmp-trap-group# no trap-target ops-mon-4
A:node-2>config>log>snmp-trap-group# exit
A:node-2>config>log# no snmp-trap-group 10
```

7.7.4.14 Modifying a log filter

You can modify the configuration of a log filter.

Example: MD- CLI

The following example shows a log filter configuration.

```
[ex:/configure log]
A:admin@node-2# info
...
  filter "1" {
    description "This is a sample filter with default action drop."
    default-action drop
  }
...

```

The following example shows the modifications applied to the log filter configuration.

```
[ex:/configure]
A:admin@node-2# log filter 1

[ex:/configure log filter "1"]
A:admin@node-2# description "This filter allows forwarding"

[ex:/configure log filter "1"]
A:admin@node-2# default-action forward

A:admin@node-2#

```

The following example shows the results of the modifications to the log filter configuration.

```
A:node-2>config>log>filter# info
-----
...
  filter name "1"
    description "This filter allows forwarding"
    default-action forward
  exit
exit
...
-----

```

Example: classic CLI

The following example shows a log filter configuration.

```
A:node-2>config>log# info
#-----
echo "Log Configuration "
#-----
...
  filter name "1"
    default-action drop
    description "This is a sample filter."
    entry 1
      action forward
      match
        application eq "mirror"
        severity eq critical
    exit
  exit
exit
...

```

The following example shows the modifications applied to the log filter configuration.

```
A:node-2>config# log
*A:node-2>config>log# filter 1
*A:node-2>config>log>filter# description "This allows <n>."
*A:node-2>config>log>filter# default-action forward
*A:node-2>config>log>filter# entry 1
*A:node-2>config>log>filter>entry$ action drop
*A:node-2>config>log>filter>entry# match
*A:node-2>config>log>filter>entry>match# application eq user
*A:node-2>config>log>filter>entry>match# number eq 2001
*A:node-2>config>log>filter>entry>match# no severity
*A:node-2>config>log>filter>entry>match# exit
```

The following example shows the results of the modifications to the log filter configuration.

```
A:node-2>config>log>filter# info
-----
...
    filter name "1"
      description "This allows <n>."
      entry 1
        action drop
        match
          application eq "user"
          number eq 2001
        exit
      exit
    exit
  exit
...
-----
```

7.7.4.15 Modifying event control configuration

You can modify the current event control configuration.

Example: MD-CLI

The following example shows a current event control configuration.

```
[ex:/configure log]
A:admin@node-2# info
log-events {
  bgp event tmnx0spfVirtIfStateChange {
    generate false
    throttle false
  }
  ospf event tmnx0spfVirtNbrStateChange {
    severity cleared
    throttle false
  }
  ospf event tmnx0spfLsdbOverflow {
    severity critical
    throttle false
  }
}
throttle-rate {
  limit 500
```

```
    interval 10
  }
```

The following example shows a modification to the event control configuration.

```
*[ex:/configure log]
A:admin@node-2# log-events bgp 2014 suppress
```

The following example shows the modified event control configuration.

```
*[ex:/configure log]
A:admin@node-2# event-control ospf 2014 suppress
```

Example: classic CLI

The following example shows a current event control configuration.

```
A:node-2>config>log# info
-----
...
event-control "bgp" 2014 generate critical
...
-----
```

The following example shows a modification to the event control configuration.

```
*A:node-2>config# log
*A:node-2>config>log# event-control bgp 2014 suppress
```

The following example shows the modified event control configuration.

```
*A:node-2>:config# log
*A:node-2>config>log# event-control ospf 2014 suppress
```

7.7.4.16 Returning to the default event control configuration

Use the following command to delete modified log event options and return them to the default values:

- **MD-CLI**

```
configure log log-events delete event option
```

- **classic CLI**

```
configure log no event-control application [event-name | event-number]
```

The following example shows the command usage.

Example: MD-CLI

```
[ex:/configure log log-events]
A:admin@node-2# delete snmp event authenticationFailure
```

Example: classic CLI

```
A:node-2>config>log# no event-control "bgp" 2001
```

8 Node discovery provisioning using OSPF

Some operators use third-party or self-build NMS and need to discover the nodes using OSPF and its Type 10 opaque LSA TLV. When a node is discovered through OSPF, the NMS pushes the new configuration to the node and perform any other required modifications using CLI (SSH or Telnet).

8.1 Node discovery procedure

A node is configured with a network element profile. A network element profile has all of the necessary information for node discovery, including the node NEID, NEIP, Vendor Identifier, chassis type, and MAC address. The network element profile can be added to an OSPF area in VPRN and when it is, the network element information is advertised using OSPF type 10 opaque LSA to the rest of the network. These discovery procedures are only available in VPRN.

An aggregation node (node closest to the NMS) gathers all of the network element information received using OSPF and converts this information into a MIB. When configured, the aggregation node also generates traps as necessary to update the NMS. In addition to the traps, the NMS can walk the MIB table to update its new view of the network. Use the following command to configure the trap generation:

```
configure system network-element-discovery generate-traps
```

The node is discovered using an IPv4 or IPv6 NEIP, but the advertisement protocol is always OSPFv2 (OSPFv3 is not supported). However, if the NMS wants to discover a node in an IPv6 network, you must enable both OSPFv2 and OSPFv3. OSPFv2 advertises the node information to the aggregation node to generate the traps and build the MIB table, and OSPFv3 provides the routing information required to reach that node using an IPv6 network.

The following minimum configuration is required on the node so that it can be discovered:

- a management VPRN
- a network element profile configured under the **configure system network-element-discovery** context
- a loopback or physical L3 interface in the VPRN with same IP address as the network element profile NEIP
- a physical interface in the VPRN (SAP) with an optional unnumbered interface inheriting the IP address from the loopback IP (this is light VPRN where the uplink is a SAP and not a spoke SDP)
- an optional VLAN DOT1Q support for the L3 interface
- a temporary username and password. This could be the default.
- OSPF on the physical L3 interface in the VPRN (SAP). OSPF must be configured as P2P and has an additional flag to include the LSA type 10 opaque value.
- SSH or Telnet management enabled on the VPRN, these are disabled by default

As all discovery is done using the VPRN SAP, there is no need for GRT configuration.

8.1.1 Configuring network element profiles

You can create a Network Element (NE) profile for the system with all the information needed for node discovery. The NE information is flooded to the network using IGP.

Use the commands in the following context to configure an NE discovery profile.

```
configure system network-element-discovery profile
```

You can assign the NE discovery profile to a VPRN OSPFv2 area for advertisement. You can only create one profile for each node.

Example: MD-CLI

```
[ex:/configure system network-element-discovery]
A:admin@node-2# info
  profile "testProfile" {
    neid 0x91001
    neip {
      ipv4 128.9.10.1
    }
  }
}
```

Example: classic CLI

```
A:node-2>config>system>ned# info
-----
      profile "testProfile" create
        neid 0x091001
        neip
          ipv4 128.9.10.1
        exit
      exit
-----
```

8.1.2 Advertising an NE profile using OSPF

When you assign an NE profile to OSPFv2, its information is advertised using LSA type 10 opaque.

Use the following command to assign an NE profile to OSPFv2.

```
configure service vprn ospf area advertise-ne-profile
```

The NE information is not added to the Routing Information Base (RIB) table or Forwarding Information Base (FIB) table, this includes the NEIP. If the NEIP of the profile needs to be visible to the network then a loopback interface or a physical interface must be configured with the same IP address as the NEIP and added to the OSPFv2 area.

For example, if the following profile is created, the NEIP is duplicated in a loopback interface address. This is because the NEIP is only used in type 10 LSA and is not added to the RIB or FIB. Type 10 LSA is only used to relay the information to the NMS. As such, the loopback interface with the same IP address as the NEIP, must be assigned to the same OSPF area to ensure the address is injected into the RIB and FIB of all nodes and is reachable. If this loopback interface is not configured and not added to OSPF then SR OS does not have any route entry in the RIB or FIB for the NEIP.

Example: MD CLI

```
[ex:/configure system network-element-discovery]
A:admin@node-2# info
  profile "testProfile" {
    neid 0x91001
    neip {
      ipv4 128.9.10.1
    }
  }
[ex:/configure service vprn "1"]
A:admin@node-2# info
  interface "loopback" {
    loopback true
    ipv4 {
      primary {
        address 128.9.10.1
        prefix-length 24
      }
    }
  }
  interface "uplink" {
  }
  ospf 0 {
    area 0.0.0.0 {
      advertise-ne-profile "testProfile"
      interface "loopback" {
      }
      interface "uplink" {
      }
    }
  }
}
```

Example: classic CLI

```
A:node-2>config>system>ned# info
-----
  profile "testProfile" create
    neid 0x091001
    neip
      ipv4 128.9.10.1
    exit
  exit
-----
A:node-2>config>service>vprn# info
-----
  interface "loopback" create
    address 128.9.10.1/24
    loopback
  exit
  interface "uplink" create
  exit
  ospf
    shutdown
    area 0.0.0.0
      advertise-ne-profile "testProfile"
      interface "loopback"
        no shutdown
      exit
      interface "uplink"
        no shutdown
      exit
    exit
  exit
```

exit

8.1.3 OSPFv2 opaque LSA requirements

OSPF Opaque LSA packets are made up of the following, as shown in [Figure 24: OSPF opaque LSA packet](#).

- LSA ID is 202.255.238.0
- opaque type value is 202
- instance value is 255.238.0 (ffee00)

Figure 24: OSPF opaque LSA packet

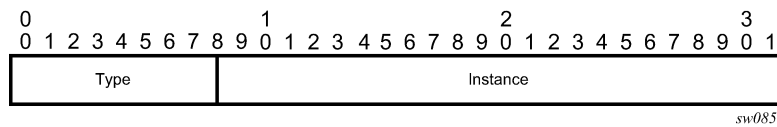

Note: Type 10 opaque LSA can only be added to OSPFv2 and not OSPFv3.

OSPF Opaque LSA type 10 TLV contains the following information:

- **vendor identifier**
This is the vendor-id (vendor defined string).
 - type is 0x8000
 - length is length of identify string
 - default value is "Nokia"
- **equipment identifier**
This is the product-id (vendor defined string).
 - type is 0x8001
 - length is length of identify string
 - default value is "chassis-name, chassis-type"
- **system-mac**
This refers to node system MAC (node unique).
 - type is 0x8002
 - length is 6
 - default value is chassis MAC address
- **NEID**
This refers to node hostname (customer defined).
 - type is 0x8003
 - length is 4

- **NEIP IPv4**

This refers to loopback IPv4 address (preconfigured).

- type is 0x8004
- length is 4

- **NEIP IPv6**

This refers to loopback IPv6 address (preconfigured).

- type is 0x8005
- length is 16

8.1.4 IPv4/IPv6

Both IPv4 and IPv6 node discovery is supported. However, LSA type 10 is only advertised on OSPFv2 and not OSPFv3. If the operator wants to use IPv6 or dual-stack, OSPFv2 must be configured under VPRN to advertise the node information using LSA type 10 opaque. In addition, OSPFv3 can also be enabled to advertise IPv6 routes and interfaces for IPv6 reachability. If both IPv4 and IPv6 are configured on the loopback interface within the VPRN (dual-stack) then both values are sent in the OSPFv2 LSA type 10, NMS prefers one over the other. In this case, all discovered routers must be configured with dual-stack OSPFv2 and OSPFv3.

8.2 Auto-provisioning using OSPF

SR OS supports the OSPF option for ZTP. The network element identifier (NEID) is configured using the chassis MAC address and the network element IP address (NEIP) is derived from the NEID. The first few slots and ports are auto-provisioned and the ZTP process tries to establish OSPF adjacency on these slots and ports to communicate the node information using type 10 opaque LSAs.

8.2.1 NEID

On a data communication network (DCN), a network element (NE) is uniquely identified by an ID (NEID), not by an IP address. Each NE is assigned a default NEID manually or through the auto-provisioning process.

The assigned NEIDs on a specific DCN must be different from each other because they represent the unique identities of the NEs on that DCN. If the NEIDs of two NEs on a DCN are identical, route flapping occurs.

The NEID range is from 0x10001 to 0xFEFFFFE and consists of a subnet ID and basic ID. The first 8 most significant bits represent the subnet ID, which ranges from 0x1 to 0xFE. The 16 least significant bits represent the basic ID, which ranges from 0x0001 to 0xFFFFE.

8.2.2 NEIP

NEIP addresses help managed terminals to access the NEs and allow addressing between NEs in IP networking. An NEIP address consists of a network number and a host number. A network number uniquely identifies a physical or logical link. All NEs along the same link have the same network number. A

network number is obtained using the AND operation on the 32-bit IP address and corresponding subnet mask.

The NEIP address is derived from the NEID when the NE is initialized. The NEIP address is in the format *140.subnet number.basic ID*. The vendor has assigned 140.x.y.z for Nokia routers.

For example, if the NEID is 0x09BFE0, which is 1001.10111111.11100000 in binary format, the NEIP address is derived as follows.

- The subnet number is represented by the 8 most significant bits 00001001, which is 9 in decimal format. 9 is the default value.
- The basic ID is represented by the 16 least significant bits 10111111.11100000, which is 191.224 in decimal format.
- The NEIP address derived from the NEID 0x09BFE0 is 140.9.191.224.

Until the NEIP is configured manually, the NEIP address is derived from the NEID; changes to the NEID cause the associated NEIP address to change. After the NEIP address is configured manually, that NEIP no longer changes when the associated NEID changes.

8.2.3 NEIP and NEID autogenerate CLI configuration

The IPv4 format of NEIP is x.y.a.b. Where:

x is the vendor ID value

y is NEID subnet

a.b is the host portion of the NEID.

Use the following CLI commands to configure NEID and NEIP autogeneration

- Use the following command to configure the NEID.

```
configure system network-element-discovery profile neid
```

The NEID can be set manually or the host portion can be set. If the host portion is set, the subnet is automatically set to 09.

- Use the following commands to configure the NEIP in IPv4 and IPv6 formats, respectively.

```
configure system network-element-discovery profile neip ipv4
configure system network-element-discovery profile neip ipv6
```

When the NEIP is derived from the NEID, the NEID value is used as the subnet number and the host portion of the NEIP. You can configure the vendor ID value. The default vendor ID value is 140.

8.2.4 Auto-provisioning using OSPF

The node is auto-provisioned using OSPF if the **auto-boot ospf** flag is set in the BOF. When this flag is set, the node automatically creates the necessary configuration for a management VPRN and automatically generates the NEIP as described in [Autogenerate configuration](#). The NEID must be configured and staged as described in [NEIP and NEID autogenerate CLI configuration](#).

8.2.4.1 Autogenerate configuration

When the **auto-boot ospf** flag is set in the BOF, the node is configured in the following sequence:

1. west and east port configuration and the associated MTU
2. a management VPRN
3. a network element **profile** configured under the following context.

```
configure system network-element-discovery
```

4. router ID in VPRN set to the NEIP address
5. loopback interface in VPRN with the same IP address configured as the network element profile NEIP
6. a physical interface in VPRN (SAP) with an unnumbered interface that inherits the IP from the loopback IP (this is light VPRN, where the uplink is a SAP and not a spoke SDP)
7. VLAN dot1q support for the above L3 interface with the VLAN set to 4094
8. a temporary username and password configured for the node, which can be the default
9. OSPF on the physical L3 interface in the VPRN (SAP). OSPF is configured as P2P and has an additional flag to include the type 10 opaque LSA value.
10. Telnet and FTP servers enabled under the **system security** context
11. SSH, Telnet, and FTP management are supported in the VPRN; they are disabled by default.

Node discovery is done through a VPRN and SAP interface. A GRT configuration is not required.

8.2.4.1.1 Autogenerate NEID configuration

When the **auto-boot ospf** flag is used without any options, the NEID is autogenerated from the chassis MAC address. The least significant bytes of the chassis MAC address can be 00 or FF. These values are invalid as least significant bytes of an IP address. SR OS uses the following methods to mitigate these invalid bytes:

- For IPv4, the least significant chassis MAC bytes (3 to 5) are used to generate the NEID. The bytes are shift to the left by 2 bits and "logical OR"-ed with 01 to generate the least significant 3 bytes of the IPv4 address.
- For IPv6, the least significant chassis MAC bytes (2 to 6) are used to generate the NEID. The bytes are shift to the left by 2 bits and "logical OR"-ed with 01 to generate the least significant 5 bytes of the IPv6 address.

8.2.4.2 The auto-boot ospf flag and options

If the **auto-boot ospf** flag is set in the BOF, the node enters auto-discovery mode and automatically creates the management VPRN and its required configuration.

The **auto-boot ospf** flag options can be set manually in the BOF or by editing the `bof.cfg` file. For information about these options, see the **auto-boot ospf** command description in the CLI help or the command reference guide:

- *7450 ESS, 7750 SR, 7950 XRS, and VSR MD-CLI Command Reference Guide*
- *7450 ESS, 7750 SR, 7950 XRS, and VSR Classic CLI Command Reference Guide*

8.2.4.3 CLI generation of the loopback address and router ID using auto-boot ospf options

The loopback address and the Router ID in the management VPRN are set to the NEIP address automatically. When **auto-boot ospf** is executed, the configuration is generated automatically.

After node connectivity has been established, these addresses can be changed by an administrator account. If these addresses are changed using the CLI, OSPF renegotiates its neighboring session and uses the new addresses.

The only way to regenerate these addresses automatically is to change the **bof auto-boot ospf** option and to reboot the node.

If no options are specified for **auto-boot ospf**, the management VPRN configuration is set as follows:

- NEID host must be set by the user.
- NEIP vendor-id-value is set to 140.
- The node goes through the ports with links operationally up and tries to establish OSPF adjacencies. If the OSPF adjacency is established on an interface, the interface is kept and the LSA type 10 TLV is advertised. The node can bring up multiple OSPF adjacencies in the discovery mode.
- Port MTU is set to the default value for the port type.
- OSPF MTU is set to 1500.

If options are specified for **auto-boot ospf**, they are used when the management VPRN CLI is created automatically. The mapping of the **auto-boot ospf** options to CLI commands is displayed in [Table 52: Mapping of auto-boot ospf options to CLI commands](#)

Table 52: Mapping of auto-boot ospf options to CLI commands

| Option | Commands |
|---|---|
| neid | <code>configure system network-element-discovery profile neid <i>hex-string</i></code> |
| neip-ipv4 | <code>configure system network-element-discovery profile neip ipv4 <i>a.b.c.d</i></code> |
| neip-ipv6 | <code>configure system network-element-discovery profile neip ipv6 <i>x:x:x:x:x:x</i></code> |
| no explicit neip-ipv4 or neip-ipv6 | <code>configure system network-element-discovery profile neip ipv4 auto-generate</code> and <code>configure system network-element-discovery profile neip ipv6 auto-generate</code> |
| vendor-id set and no explicit neip-ipv4 or neip-ipv6 <i>value</i> | <code>configure system network-element-discovery profile neip ipv4 auto-generate [vendor-id-value <i>value</i>]</code> and <code>configure system network-element-discovery profile neip ipv6 auto-generate [vendor-id-value <i>value</i>]</code> |
| ospf-mtu | <code>configure service vprn ospf area interface mtu</code> |
| port-mtu | <code>configure port ethernet mtu</code> |

8.2.4.3.1 Auto-provisioning details

The node is shipped with the default `bof.cfg` file. The operator must stage the node and execute **auto-boot ospf** and the NEID accordingly.

At bootup, the application reads the **ospf** flag and performs the following functions:

- The node discovers and provisions the chassis and the cards according to the connectivity requirement for the chassis.

The card and slot discovery and provisioning depend on whether the **port** option is set under **auto-boot ospf**. If the **port** option is set, the corresponding IOM or MDAs are discovered.

- It does not load any configuration file.
- If you set only the option **neid** for **auto-boot ospf**, the following occurs.
 - A vendor ID value of 140 is assigned automatically.
 - Vendor ID is the most significant byte in the NEIP. By default, it is set to 140.
 - Default ports and default MTUs are set up automatically.
 - The configuration is set up based on these default values.
- If you set additional options for **auto-boot ospf**, the following occurs:

- These values are used to generate the configuration as described in [CLI generation of the loopback address and router ID using auto-boot ospf options](#).

Vendor ID is the most significant byte in the NEIP. By default, it is set to 140.

- Either all or some of these options can be set. The options that are not set remain at their default values.
- These configured options generate the configuration as described in [CLI generation of the loopback address and router ID using auto-boot ospf options](#).
- Always disable **generate-traps** because it applies only to non-aggregation nodes.

- **MD-CLI**

```
configure system network-element-discovery generate-traps false
```

- **classic CLI**

```
configure system network-element-discovery no generate-traps
```

This configuration process forces the node to generate its auto-discovery profile and to advertise it through OSPF to the rest of the network.

An aggregation node must be configured manually and cannot be auto-discovered. This is because the node is connected to the NMS and must have an SNMP configuration to connect to the NMS.

Use the following commands to configure the node to generate the NEIP automatically.

```
configure system network-element-discovery profile neip ipv4 auto-generate
configure system network-element-discovery profile neip ipv6 auto-generate
```

If either of the following are set, the IP address is 140.9.c.d.

```
auto-boot ospf vendor-id 140
```

```
configure system network-element-discovery profile vendor-id Nokia
```

When the NMS has discovered the nodes, the NMS or the user can SSH to the node and clear the **auto-boot ospf** flag manually. In addition, the following operational guidelines apply:

- After node discovery, all management and operations are performed through Telnet, SSH, or SNMP.
- The NE profile and management VPRN and its configuration that was autogenerated (as described in [Autogenerate configuration](#)) are not deleted, unless explicitly deleted by the user. These are valid configurations generated automatically during auto-provisioning. They should perform the following actions to manage these valid, autogenerated configuration.
 1. Execute an **admin save** to save these configurations in the configuration file. If a previous configuration file exists, the existing configuration file is backed up and a new configuration file with the current configuration is saved on the compact flash (CF).
 2. Run the already existing configuration file. The management VPRN configuration should not overlap with the existing configuration file that is being executed.

8.2.4.4 Connectivity requirements

Most access topologies are ring-based, for which two interfaces are required with OSPF adjacency in VPRN. Two ports based on the chassis and **auto-boot ospf** options must be created and used to establish OSPF neighbor adjacencies. These interfaces should be created with VLAN 4094 for the auto-discovery process.

8.2.4.5 Auto-provisioning success

The node declares auto-provisioning success when the OSPF adjacency is created and the node has advertised the type 10 opaque LSA TLV with the node information using OSPF. When a single OSPF adjacency is created, the **auto-boot ospf** process declares success and does not reboot the node; the node resumes normal operational mode. However, the process tries indefinitely to bring up OSPF on other ports with link up.

If the NMS has discovered the node, the operator can log in to the node and disable **auto-boot ospf**.

To terminate **auto-boot ospf**, the user must Telnet or SSH to the node and use the option in the user prompt or the **tools** command.

8.2.4.6 Auto-boot OSPF reboot timers

If **auto-boot ospf** is not successful (that is, no OSPF adjacency is found) for 30 minutes, the node is rebooted and **auto-boot** is retried.

8.2.4.7 Auto-boot OSPF relation with auto-boot

The **auto-boot** command without the **ospf** flag executes ZTP with DHCP discovery. The **ospf** flag forces the node discovery using OSPF.

8.2.4.8 Auto-provisioning log options

Detailed auto-provisioning logs are gathered in a dedicated log queue that can be displayed with the **tools dump auto-boot log** command. At the end of ZTP, these logs are also written to the autoboot.log file.

8.2.4.9 Console access during auto-provisioning

While the node is running auto-provisioning, the console is accessible and node configuration is possible and accepted. If the configuration is saved during the auto-provisioning, the save operation is honored. If ZTP is running in the background, a warning message is displayed on each login to notify the user that the system can reboot as a result of ZTP.

8.2.4.10 Disabling OSPF auto-provisioning

If the node is executing auto provisioning (auto-boot), a warning message is displayed when the user logs in. The warning message gives the user the option of terminating the auto-boot process. The **auto-boot ospf** flag is cleared only if the user logs into the discovered node and disables the flag using Telnet/SSH or SNMP.

Auto-boot OSPF provisioning is a one-step process. If the OSPF adjacency is successfully initiated to the neighbor and goes operationally up, OSPF advertises the NE profile to the neighbor.

The management VPRN is deleted only if the user explicitly deletes it using VPRN configuration commands.

8.2.5 CLI structure

The NE discover feature supports profiles for NE discovery information. You can configure multiple profiles and assign each profile to a different VPRN. Each VPRN can only have a single profile and therefore a single NEID and NEIP.

Use the commands in the following context to configure NE discovery profiles.

```
configure system network-element-discovery profile
```

8.2.5.1 Assigning the NE-discovery profile to IGP

You can assign an NE profile to advertise under a VPRN OSPF area. When you assign the profile to advertise, OSPF advertises the NE information to its neighbors through type 10 opaque LSA.

Use the following command to assign an NE profile to advertise under a VPRN OSPF area.

```
configure service vprn ospf area advertise-ne-profile
```

8.3 Aggregation node configuration

An aggregation node, attached to NMS through a VPRN service, aggregates all nodes to be discovered using the same VPRN. The node is configured with:

- a management VPRN
- a loopback address in VPRN
- a physical interface in the VPRN with an optional unnumbered interface inheriting the IP address from the loopback IP (this is a light VPRN where the uplink is a SAP and not a spoke SDP)
- optional VLAN DOT1Q support for the L3 interface
- OSPF on the physical L3 interface in the VPRN (SAP)
- SNMP (SNMPv3) on an L3 interface in the VPRN (SAP) toward the NMS
- a MIB table build based on the OSPF type 10 opaque LSA and stored in the OSPF opaque database

This node converts the OSPF LSA type 10 opaque information arriving from the discovered nodes into an SNMP MIB table and updates the NMS with the MIB. The NMS uses the MIB to discover the node and opens a SSH or Telnet session to configure the node accordingly.

The node to be discovered is provisioned with a management VRF as described in [Node discovery procedure](#). All of the necessary node information needed for the node discovery is advertised by OSPF using LSA type 10 opaque. Nodes can be chained together, so the LSA type 10 needs to be forwarded all the way to the aggregation node.

NMS discovers the node using SNMP MIB traps or it can walk the MIB table.

NMS connects to the discovered node using SSH or Telnet to update the configuration by CLI. The operator must ensure that none of their commands disable the management VPRN and disconnect the discovered node from NMS.

8.3.1 MIB requirements on the aggregation node

A new vendor-proprietary MIB table for node discovery, `tmnxVRtrNeInfoTable`, is defined as part of `TIMETRA-VRTR-MIB.mib`. This MIB table is used by the NMS to gather all node information by walking the table, for example, after an NMS reboot.

This MIB table is built on any node that receives OSPF type 10 LSA.

The MIB table should be built with a key of VRF and NEID and a data portion of `neid`, `vendor identify`, `platform type`, `system-mac`, `neip-v4`, and `neip-v6`.

The MIB parameters are:

- The company name is configurable using the CLI and is a string, but by default, "Nokia" is sent.

```
tmnxSysNEProfVendorId      OBJECT-TYPE
    SYNTAX      DisplayString
    MAX-ACCESS  read-create
    STATUS      current
    DESCRIPTION
        "The value of tmnxSysNEProfVendorId specifies the
        vendor identifier."
    DEFVAL      { "Nokia" }
    ::= { tmnxSysNEProfEntry 11 }
```

- The device type is configurable and is a string, but by default, the chassis-name and the chassis-type is sent.

```
tmnxSysNEProfPlatformType  OBJECT-TYPE
    SYNTAX      DisplayString
    MAX-ACCESS  read-create
```

```

STATUS      current
DESCRIPTION
  "The value of tmnxSysNEProfPlatformType specifies
the product identifier.
  An empty string indicates this object is not
configured, the chassis name and chassis type will be
used."
DEFVAL      { ''H }
::= { tmnxSysNEProfEntry 10 }

```

- The `tmnxSysNEProfNeipV4` and `tmnxSysNEProfNeipV6` objects are the NEIPs configured using the CLI.

```

tmnxSysNEProfNeipV4Type      OBJECT-TYPE
SYNTAX      InetAddressType
MAX-ACCESS  read-create
STATUS      current
DESCRIPTION
  "The value of tmnxSysNEProfNeipV4Type specifies
the IP address type of tmnxSysNEProfNeipV4.
  The value of tmnxSysNEProfNeipV4Type can be either
of 'ipv4(1)' or 'unknown(0)'.
  The value of 'unknown(0)' specifies no NEIP v4
address is configured."
DEFVAL      { unknown }
::= { tmnxSysNEProfEntry 5 }

tmnxSysNEProfNeipV4          OBJECT-TYPE
SYNTAX      InetAddress (SIZE (0|4))
MAX-ACCESS  read-create
STATUS      current
DESCRIPTION
  "The value of tmnxSysNEProfNeipV4 indicates the
IPv4 address of the Network Element."
DEFVAL      { ''H }
::= { tmnxSysNEProfEntry 6 }

tmnxSysNEProfNeipV6Type      OBJECT-TYPE
SYNTAX      InetAddressType
MAX-ACCESS  read-create
STATUS      current
DESCRIPTION
  "The value of tmnxSysNEProfNeipV6Type specifies
the IP address type of tmnxSysNEProfNeipV6.
  The value of tmnxSysNEProfNeipV6Type can be either
of 'ipv6(2)' or 'unknown(0)'.
  The value of 'unknown(0)' specifies no NEIP v6
address is configured."
DEFVAL      { unknown }
::= { tmnxSysNEProfEntry 7 }

tmnxSysNEProfNeipV6          OBJECT-TYPE
SYNTAX      InetAddress (SIZE (0|16))
MAX-ACCESS  read-create
STATUS      current
DESCRIPTION
  "The value of tmnxSysNEProfNeipV6 indicates the
IPv6 address of the Network Element."
DEFVAL      { ''H }
::= { tmnxSysNEProfEntry 8 }

tmnxSysNEProfSystemMac       OBJECT-TYPE
SYNTAX      MacAddress
MAX-ACCESS  read-create
STATUS      current

```

```

DESCRIPTION
  "The value of tmnxSysNEProfSystemMac specifies
  the system MAC address of the node.
  A value of all zeros indicates this object is
  not configured, the chassis MAC address will be used."
  DEFVAL      { '000000000000'H }
  ::= { tmnxSysNEProfEntry 9 }

```

The MIB walk is as follows:

```

tmnxVRtrNelInfoNeidHex.7.0.65.66.67 = STRING: 0:41:42:43
tmnxVRtrNelInfoNeipV4Type.7.0.65.66.67 = INTEGER: ipv4(1)
tmnxVRtrNelInfoNeipV4.7.0.65.66.67 = Hex-STRING: 80 09 0A 01
tmnxVRtrNelInfoNeipV4PrefixLen.7.0.65.66.67 = Gauge32: 32
tmnxVRtrNelInfoNeipV6Type.7.0.65.66.67 = INTEGER: ipv6(2)
tmnxVRtrNelInfoNeipV6.7.0.65.66.67 = Hex-STRING: 3F FE 00 00 00 00 00 00 00 00 00 00 80 09 0A 01
tmnxVRtrNelInfoNeipV6PrefixLen.7.0.65.66.67 = Gauge32: 128
tmnxVRtrNelInfoSystemMac.7.0.65.66.67 = STRING: e:0:0:0:0:1
tmnxVRtrNelInfoPlatformType.7.0.65.66.67 = STRING: Dut-B,7750 SR-12e_ndef
tmnxVRtrNelInfoVendorId.7.0.65.66.67 = STRING: NokiaNotDefault

```

8.3.2 SNMP traps and gets

The NMS should be able to walk the entire discovery table or get a specific row using the appropriate key. This is required when the NMS is rebooted or needs to update its entire database.

If you configure the following command, every time a node is updated, added, or removed from the OSPF opaque database (using LSA type 10 opaque update) the system sends a trap to notify the NMS of the change.

```
configure system network-element-discovery generate-traps
```

The following traps are sent:

- {tmnxVRtrNelInfoNeidHex.4.0.65.66.67 00:41:42:43}
- {tmnxVRtrNelInfoNeipV4Type.4.0.65.66.67 ipv4}
- {tmnxVRtrNelInfoNeipV4.4.0.65.66.67 0x80:09:0a:01}
- {tmnxVRtrNelInfoNeipV4PrefixLen.4.0.65.66.67 32}
- {tmnxVRtrNelInfoNeipV6Type.4.0.65.66.67 ipv6}
- {tmnxVRtrNelInfoNeipV6.4.0.65.66.67 0x3f:fe:00:00:00:00:00:00:00:00:00:00:80:09:0a:01}
- {tmnxVRtrNelInfoNeipV6PrefixLen.4.0.65.66.67 128}
- {tmnxVRtrNelInfoSystemMac.4.0.65.66.67 0e:00:00:00:00:01}
- {tmnxVRtrNelInfoPlatformType.4.0.65.66.67 {Dut-B,7750 SR-12e_ndef}}
- {tmnxVRtrNelInfoVendorId.4.0.65.66.67 NokiaNotDefault}

9 Public key infrastructure

9.1 X.509v3 certificate overview

X.509v3 is an ITU-T standard which consists of a hierarchical system of Certificate Authorities (CAs) that issue certificates that bind a public key to particular entity's identification. The entity's identification could be a distinguished name or an alternative name such as FQDN or IP address.

An end entity is an entity that is not CA. For example an end entity can be a web server, a VPN client, or a VPN gateway.

A CA issues a certificate by signing an entity's public key with its own private key. A CA can issue certificates for an end entity as well as for another CA. In the case when a CA certificate is issued by itself (signed by its own private key), then this CA is called the root CA. Thus, an end entity's certificate could be issued by the root CA or by a subordinate CA (this is issued by another subordinate CA or root CA). When there are multiple CA involved, it is called a chain of CAs.

A PKI also includes the mechanism for revoking certificates because of reasons such as a compromised private key.

The certificate can be used for different purposes. One purpose is authentication. Typically certificate authentication functions as following:

- The system trusts a CA as trust anchor CA (which typically is a root CA). This means that all certificates issued by a trust anchor CA, or the certificates issued by a sub CA issued by the trust anchor CA, are consider trusted.
- A peer to be authenticated presents its certificate along with a signature over some shared data between the peer and system, which is signed by using a private key.
- The signature is verified by using the public key in the certificate. And the certificate itself is verified that is issued by the trust anchor CA or a sub-CA in a chain up to the trust anchor CA. The system can also check if the peer's certificate has been revoked. Only when all these verifications succeed, then the certificate authentication succeeds.

9.1.1 SR OS X.509v3 certificate support

SR OS PKI implementation supports the following features:

- Supported public key algorithm: RSA/DSA/ECDSA:
- Certificate enrollment includes:
 - Locally generated RSA/DSA/ECDSA key
 - Off-line enrollment via PKCS#10
 - On-line enrollment via Certificate Management Protocol version 2 (CMPv2)
 - On-line enrollment via Enrollment over Secure Transport Protocol (EST)
- Support CA chain
- Certificate revocation check:

- CRL for both EE (End Entity) and CA certificate
- OCSP for EE certificate only

9.1.2 Local storage

The SR OS requires the following objects to be stored locally as file:

- CA Certificate
- CRL
- System's own certificate
- System's own key

All above objects must be imported before they can be used by the SR OS. This is performed by using the **admin certificate import** command. The import process converts the format of input file to DER, encrypts it and saves it in cf3:/system-pki directory.

The imported file can also be exported as one to use in the specified format by means of the **admin certificate export** command.

The **admin certificate import** and **admin certificate export** command supports following formats:

- Certificates can be import/export by using following formats:
 - PKCS#12
 - PKCS#7 (DER and PEM)
 - PEM
 - DERIf there are multiple certificates in the file, only the first one is used.
- Key pair can be import/export by using following formats:
 - PKCS#12 (must along with certificate)
 - PEM
 - DER
- CRL can be import/export by using following formats:
 - PKCS#7 (DER and PEM)
 - PEM
 - DER
- PKCS#12 file can be encrypted with a password.

9.1.3 CA-profile

In SR OS, CA-related configuration is stored in a CA-profile which contains following configurations:

- name and description
- CA's certificate (an imported certificate)
- CA's CRL (an imported CRL)

- revocation check method (specifies the way CA checks the revocation status of the certificate it issued)
- CMPv2 (a CMPv2 server related configurations)
- OCSP (an OCSP responder related configurations)

When user enables a ca-profile (no shutdown), the system loads the specified CA certificate and CRL into memory. And following checks are performed:

- **for CA certificate**
 - All non-optional fields defined in section 4.1 of RFC 5280, *Internet X.509 Public Key Infrastructure Certificate and Certificate Revocation List (CRL) Profile*, must exist and conform to the RFC 5280 defined format.
 - Check the version field to see if its value is 0x2.
 - Check the Validity field to see that if the certificate is still in validity period.
 - X509 Basic Constraints extension must exist and CA Boolean must be True.
 - If Key Usage extension exists, then at least keyCertSign and cRLSign should be asserted.
- **for CRL**
 - All non-optional fields defined in section 5.1 of RFC 5280 must exist and conform to the RFC 5280 defined format.
 - If the version field exists, the value must be 0x1.
 - The delta CRL Indicator must not exist (Delta CRL is not supported).
 - CRL must be signed by the configured CA certificate.

CRL, by default, is required to enable ca-profile, but it could be optional by changing the revocation check method configuration. For the revocation check method configuration, see [Certificate revocation check](#).

9.1.4 CA chain computation

In case of verifying a certificate with a CA or a chain of CAs, the system needs to identify the issuer CA of the certificate in question. The SR OS looks through all configured ca-profiles to find the issuer CA. The following is the method system used to find the issuer CA:

- The issuer CA's certificate subject must match the issuer field of the certificate in question.
- If present, the authority key identifier of the certificate in question must match the subject key identifier of the issuer CA's certificate.
- If present, the key usage extension of the issuer CA's certificate must permit certificate signing.

9.1.5 Certificate enrollment

The SR OS supports two certificate enrollment methods:

- off-line method via PKCS#10
- on-line method via CMPv2
- on-line method via EST

The off-line method works as follows:

1. Generate a key pair via the command **admin certificate gen-keypair**

For example:

```
admin certificate gen-keypair cf3:/segw.key size 2048 type rsa
```

2. Generate a PKCS#10 certificate signing request with the key generated in the step mentioned above via the **admin certificate gen-local-cert-req** command.

For example:

```
admin certificate gen-local-cert-req keypair cf3:/segw.key subject-dn  
C=US,ST=CA,O=ALU,CN=SeGW domain-name segw-1.alu.com file cf3:/segw.pkcs10
```

The user specifies the subject of certificate request and optionally can also specify a FQDN or an IP address as SubjectAltName.

3. Import the key file via the **admin certificate import** command.

For example:

```
admin certificate import type key input cf3:/segw.key output segw.key format de
```

4. Because the key is imported, remove the key file generated in the first step for security reasons.
5. Send the PKCS#10 file to CA via an offline method such as email.
6. CA signs the request, and returns the certificate.
7. Import the result certificate the **admin certificate import** command.

For example:

```
admin certificate import type cert input cf3:/segw.cert output segw.cert format pem
```

For CMPv2-based enrollment, see [CMPv2](#). For EST-based enrollment, see [Enrollment over secure transport](#).

9.1.6 Certificate revocation check

A revocation check is a process to see if a certificate has been revoked by the issuer CA.

The SR OS supports two methods for certificate revocation check:

- CRL
- OCSP

CRL can be used for both EE and CA certificate checks, while OCSP could only be used for an EE certificate.

The use of a revocation check for an EE certificate is application-specific. With an IPsec application, users can configure multiple check methods with a priority order for an EE certificate. With the **status-verify** command in the **ipsec-gw/ipsec-tunnel** configuration context, a primary method, a secondary method and a default result can be configured. The primary and secondary method can be either OCSP or CRL. The default result is either **good** or **revoked**. If the system cannot get an answer from the primary method, then it falls back to the secondary method. If secondary method also does not return an answer, then the system uses the default result.

By default, the system uses CRL to check the revocation status of a certificate, whether it is an end entity certificate or a CA certificate. This makes CRL a mandatory configuration in the **ca-profile**.

The **revocation-check** command in the **ca-profile** can change this behavior, with **revocation-check crl-optional** configured:

When a user enables the **ca-profile** (**no shutdown**), the system tries to load the configured CRL (specified by the **crl-file** command). But, if the system fails to load it for following reasons, then the system still keeps **ca-profile oper-up**, but treat the CRL as non-existent.

- The CRL file does not exist.
- The CRL is not properly encoded, possibly because of an interrupted file transfer.
- The CRL is not signed by the CA certificate configured in the CA profile.
- The CRL version is wrong.
- The CRL expired or is not yet valid.

If the IPsec application needs to use the CRL of a specific **ca-profile** to check revocation status of an end entity certificate and CRL is non-existent because of the above reasons, then the system treats it as unable to get an answer from CRL and fall back to the secondary status-verify method or default-result configured under the **ipsec-gw/ipsec-tunnel**.

If the system needs to check the revocation of a CA certificate in certificate chain, and if the CRL is non-existent because of the above reasons, then the system skips checking the revocation status of the CA certificate. For example, the CA1 is issued by CA2, if CA2's **revocation-check** is **crl-optional** and CA2's CRL is non-existent, then the system does not check CA1 certificate's revocation status and consider it as good.

The user must disable the **ca-profile** to change the revocation-check configuration.

For details about OCSP, see [OCSP](#).

9.1.7 Certificate/CRL expiration warning

The system can optionally generate a warning message before a certificate or a CRL expires. The amount of time before expiration is configurable via two system-wide CLI commands (**certificate-expiration-warning** and **crl-expiration-warning**). The warning messages can also be optionally repeated at a configured interval. For details of the warning messages, refer to the corresponding command descriptions.

If a configured EE certificate expires, the system does not bring down an established ipsec-tunnel/ipsec-gw down, however future certificate authentication fails.

If a CA certificate expires, the system brings the ca-profile operationally down. This does not affect established tunnels, however future certificate authentication that uses the ca-profile fails.

9.1.8 Certificate/CRL/key cache

Configured certificates, CRLs, and keys are cached in memory before they are used by the system.

- Every certificate/CRL/Key has one cache copy system-wide.
- For a CA certificate and CRL, the cache is created when there is a ca-profile and when it has been administratively enabled, and removed.
- For an ipsec-tunnel or ipsec-gw using legacy **cert** and **key** configurations, the cache is created only when the first tunnel using it is in an administratively enabled state, and it is cleared when the last tunnel that used it is administratively disabled.
- For an ipsec-tunnel or ipsec-gw using **cert-profile**, the cache is created when the first **cert-profile** using it is in an administratively enabled state, and removed when the last cert-profile that used it is in an administratively disabled state.

- If a certificate or key is configured with both a **cert-profile** and legacy **cert** or **key** command, then the cache is created when the first object (a **ipsec-gw**, **ipsec-tunnel** or **cert-profile**) using it is in an administratively enabled state and removed the last object using it is in an administratively disabled state.

To update a certificate or key without administratively disabling the **ca-profile** or **ipsec-tunnel/ipsec-gw**, use the following command to manually reload the certificate and key cache:

- **MD-CLI**

```
admin system security pki reload
```

See the *7450 ESS, 7750 SR, 7950 XRS, and VSR MD-CLI Command Reference Guide* for more information.

- **classic CLI**

```
admin certificate reload
```

See the *7450 ESS, 7750 SR, 7950 XRS, and VSR Classic CLI Command Reference Guide* for more information.

9.1.9 Auto CRL update

The SR OS provides an automatic mechanism to update a CRL file. The system tries to download the CRL from a list of configured HTTP URLs and replace existing CRL file when a qualified CRL is successfully downloaded. A qualified CRL is a valid CRL signed by the CA and is more recent than the existing CRL. To determine if a downloaded CRL is more recent than an existing CRL, the system compares the This-Update field of the CRL first. If they are the same, the system compares the CRL number extension if present.

The configured HTTP URL must point to a DER-encoded CRL file.

This feature supports two types of downloading schedules:

- **periodic**

The system downloads a CRL periodically at the interval configured via the **periodic-update-interval** command. For example, if the **periodic-update-interval** is 1 day, then the system downloads CRL every 1 day. The minimal periodic-update-interval is 1 hour.

- **next-update-based**

The system downloads a CRL at the time = Next_Update_time_of_current_CRL minus pre-update-time. For example, if the Next-Update of current CRL is 2015-06-30 06:00 and pre-update-time is 1 hour, then the system starts the download at 2015-06-30, 05:00.

The system allows up to eight URLs to be configured for a ca-profile. When downloading begins, URLs are tried in order, and the first successfully downloaded qualified CRL is used to update existing CRL. If the downloading fails or the downloaded CRL is not qualified, the system moves to the next URL in the list. If all URLs in the list fail to return a qualified URL, then:

- In case of next-update-based schedule, the system waits for a configured retry-interval before retrying from the first URL in the list again.
- In case of periodic schedule, the system waits until the next scheduled time.

Upon executing a **no shutdown** of a ca-profile, if the auto-crl-update is enabled, then in case configures CRL file does not exist or is expired or invalid, then the system starts downloading right away.

The system also provides an **admin** command (**admin certificate crl-update ca <ca-profile-name>**) for users to manually trigger downloading. However, it requires a shutdown of the **auto-crl-update** command (**no auto-crl-update**).

HTTP transport can be over either IPv4 or IPv6.

This feature support Base/Management/VRPN routing instance. VPLS management is not supported. In the case of VRPN, the HTTP server port can only be 80 or 8080.

9.1.10 CMPv2

CMPv2, RFC 4210, *Internet X.509 Public Key Infrastructure Certificate Management Protocol(CMP)* is a protocol between a Certificate Authority (CA) and an end entity. It provides multiple certificate management functions like certificate enrollment, certificate update, and so on.

The SR OS supports following CMPv2 operations:

- **initial registration**

This is the process the SR OS uses to enroll a certificate with a specific CA for the first time.

- Public/private key pair must be pre-provisioned before enrollment by means of local generation or other methods.
- Users can optionally include a certificate or certificate chain in the extraCerts field of the initial registration request.

- **key pair update**

This is a process for SR OS to update an existing certificate because of reasons like refreshes key/cert before it expires or any other reason.

- **certificate update**

This is a process where an initialized SR OS system obtains additional certificates.

- **polling**

In some cases, the CA may not return the certificate immediately for reasons such as **request processing need manual intervention**. In such cases, the SR OS supports polling requests and responds as described in Section 5.3.22, Polling Request and Response, in RFC 4210, *Internet X.509 Public Key Infrastructure Certificate Management Protocol (CMP)*.

The following lists some implementation details:

- HTTP is the only supported transport protocol for CMPv2. HTTP 1.1 and 1.0 are supported and configurable.
- All CMPv2 messages sent by SR OS consist of only one PKI Message. The size of the sequence for PKI Messages are 1 in all cases.
- Both the password-based MAC and the public key-based signature CMPv2 message protection are supported.
- SR OS only allows one outstanding ir/cr/kur request for each CMPv2 server. The means that no new requests are allowed if a pending request is present.

9.1.11 Encryption of imported files

There are two storage formats for imported certificates, keys, and CRLs:

- legacy, where only the imported key is encrypted
- enhanced secure, where:
 - The encryption algorithm is stronger than the legacy format.
 - Imported certificates and keys are both encrypted.
 - The internal key for encryption is chassis specific. In the case of VSR, the key is VM UUID specific.
 - A compressed format is used for imported CRL files to save space.

The legacy format is used in SR OS releases before Release 16.0.R6. The enhanced secure format is used for all imported files from Release 16.0.R6 onward. By default, the system loads an imported file in both legacy and enhanced secure formats.

Use the following command to configure the system to only load imported files in the enhanced secure format.

```
configure system security pki imported-format secure
```

Use the following command to convert imported files between the legacy format and the enhanced secure format.

```
admin certificate convert-file
```

9.1.12 Enrollment over secure transport

The Enrollment over Secure Transport (EST) protocol as specified in RFC 7030, *Enrollment over Secure Transport*, is used to enroll a certificate from a Certificate Authority (CA). SR OS supports the following EST client-side operations:

- download a CA certificate (/cacert)
- enroll a new certificate (/simpleenroll)
- renew an existing certificate (/simplereenroll)

Use the commands in the following context to perform the EST client-side operations. Each operation requires an EST profile which contains the EST configuration:

- **MD-CLI**

```
admin system security pki est
```

- **classic CLI**

```
admin certificate est
```

The following option is supported for SR OS client to authenticate the EST server:

Use the following command to configure Explicit TA which is referenced in the EST profile.

```
configure system security tls client-tls-profile trust-anchor-profile
```

No authentication is performed if this option is not configured.

The following options are supported for the EST server authentication to the SR OS client:

- Use the commands in the following contexts to achieve the client certificate authentication by configuring the certificate profile name for the client TLS profile referenced in the EST profile.

```
configure system security tls cert-profile
configure system security tls client-tls-profile
```

- Use the following command to configure HTTP authentication.

– **MD-CLI**

```
configure system security pki est-profile http-authentication
```

– **classic CLI**

```
configure system security pki est-profile http-auth
```

- Use the following command to configure the trust anchor profile name referenced in the EST profile.

```
configure system security tls client-tls-profile trust-anchor-profile
```

- No authentication is performed if the preceding options are not configured.

9.1.13 OCSP

Online Certificate Status Protocol (OCSP) (RFC 2560, *X.509 Internet Public Key Infrastructure Online Certificate Status Protocol - OCSP*) is used by SR OS applications to determine the (revocation) state of an identified certificate. Unlike CRL, which relies on checking against an off-line file, OCSP provides timely, on-line information about the revocation status of a certificate.

IPsec is the only supported application to use OCSP. With introduction of OCSP, the system supports both CRL and OCSP as the certificate revocation status checking method. For an ipsec-tunnel or ipsec-gw, the user could configure a primary method, a secondary method and a default result to achieve a hierarchical fallback mechanism. If the primary method fails to return a result, the system falls back to the secondary method. If the secondary method fails, the fall back proceeds to a default result.

The following lists implementation details:

- Only an OCSP client function is supported.
- HTTP is the only supported transport protocol.
- OCSP server access via management routing instance is not supported.
- SR OS does not sign an OCSP Request.
- The OCSP response must be signed. The system verifies the response by using the signer's certificate included in the response. If there is no such certificate, the CA certificate in the ca-profile is used.
- If a nextUpdate exists in the OCSP response, the system checks the current time <= nextUpdate. If yes, then the response is valid, otherwise the response is considered unreliable. The system moves to next revocation checking method.
- The revocation status result from a valid OCSP response is cached in the system.

- OCSP can only be used to verify the revocation status of the end-entity certificate. CRL is still needed for CA certificate's status verification.

9.1.14 Auto update certificate

SR OS supports automatic updating of an imported end-entity certificate by using an online enrollment protocol with CA. The following enrollment protocols are supported:

- CMPv2 (RFC 4210)
- EST (RFC 7030)

For each certificate that needs an automatic update, a **certificate-auto-update** command entry must be configured as well as the corresponding **certificate-update-profile** command. The **certificate-update-profile** command specifies the update behavior such as the enrollment protocol to use, the schedule type, and so on.

The following events may trigger an update:

- When the current time passes a user-specified deadline, the deadline can be configured as one of the schedule types in certificate-update-profile:
 - **before-expiry** configures the time before the certificate expiration time
 - **after-issue** configures the time after certificate issue time
- When a **certificate-auto-update** entry is configured, and it is already time to do an update.

If the certificate already expired:

- for CMPv2, the update fails because CMPv2 does not allow using an expired certificate
- for EST, if a different certificate is used for TLS authentication, the update is completed
- Manually, by using the following command.
 - MD-CLI

```
admin system security pki update-certificate
```

- classic CLI

```
admin certificate update-cert
```



Note: This feature uses the UTC, not the local time.

The following shows the workflow of a certificate update:

1. A new key is generated.

- If the following command is configured in the **certificate-update-profile**, then the system generates a new key with the same type and the same length as the existing key.

MD-CLI

```
certificate-update-profile same-as-existing-key
```

classic CLI

```
key-generation same-as-existing-key
```

- Otherwise, a new key is generated according to the key generation configuration.
2. Use the corresponding operation of the enrollment protocol specified in **certificate-update-profile** configuration to obtain a new certificate from the CA.
 - CMPv2 configures the key-update operation.
 - EST configures the renew (or /simplereenroll) operation.
 3. After the configuration obtains a new certificate from the CA (step 3), import and replace the existing key and certificate file with the same filename. The existing key and certificate file are renamed by adding a “.previous” suffix. If there are existing “xxx.previous” files, they are removed. If either of the previous fails, the existing key and certificate are not impacted.
 4. The application (for example, IPsec) that uses the certificate, reloads the key and certificate so that new key and certificate are used.
 5. If step 1, step 2, or step 3 fails, then the system waits for the retry interval specified in the **certificate-update-profile** to retry from step 1. If step 4 fails, then skip steps 1, 2, and 3 and then wait for the *retry-interval* to retry from step 4.

10 sFlow

10.1 sFlow overview

Some Layer 2 network deployments collect statistics on physical Ethernet ports and on Layer 2 interfaces at a high-frequency using a push model to, among others, monitor traffic, diagnose network issues, or provide billing. SR OS supports cflowd and XML accounting; however, those mechanisms are either Layer 3-specific, or focus on providing statistics at extremely large scale (therefore use a pull model and cannot support high-frequency counter updates). To meet the statistics collection requirements of such Layer 2 deployments, SR OS supports sFlow statistics export using sFlow version 5.

The following list gives the main restrictions for sFlow support:

- sFlow data sources require multicore line cards (IOM), enabling sFlow on a card that is not a multi-core is not blocked and can be detected by SNMP trap/log generated by sFlow
- To meet high-frequency export of counters, sFlow implementation is targeted for low per-port VLL/VPLS SAP scale only. The configuration is blocked if the per-port VLL/VPLS SAP limit exceeds sFlow limit. Contact your Nokia representative for per-platform scaling limits applicable.

10.2 sFlow features

This section describes sFlow functionality supported in SR OS.

10.2.1 sFlow counter polling architecture

When sFlow is enabled on an SR OS router, the system takes upon a role of an sFlow network device as described in sFlow protocol version 5. A single sFlow agent can be configured for counter polling (flow sampling is not supported). There is no support for sub-agents.

The sFlow agent sends sFlow data to an operator-configured sFlow receiver. A single receiver is supported with configurable primary and backup IPv4 or IPv6 UDP destination sockets for redundancy (each sFlow packet exported is duplicated to both sockets when both are configured). The receiver's UDP sockets can be reachable either in-band or out-of-band (default) and must both be IPv4 or IPv6. An operator can also set the maximum size of the sFlow datagrams. Operators are expected to set this value to avoid IP fragmentation (Datagrams exceeding the specified size are fragmented before handed to IP layer).

The sFlow agent manages all sFlow data sources in the system. SR OS supports sFlow data that are physical ports. When a port is configured as an sFlow data source, counters for that port and all VPLS and Epipe SAPs on that port are collected and exported using sFlow (see [sFlow record formats](#)). Flow data sources can only be configured when an sFlow receiver is configured. To remove the sFlow receiver, all sFlow data sources must first be deconfigured at the port level.

Each data source is processed at a 15-second, non-configurable interval. If multiple data sources exist on a line card, the line card distributes the processing of each data source within a 15 second interval to avoid sFlow storms. When a timer expires to trigger a data source processing, data is collected for the physical port and for all VLL and VPLS SAPs on that port and exported using sFlow version 5 records

as described in later subsections of this document. Each port and all SAP records for a data source for a specific interval are collected and sent with the counter sequence number and the timestamp value (the time value corresponds to the time counters were actually collected by a line card). The timestamp value uses line card's sysUptime value, which is synchronized with CPM time automatically by the system. A line card sends the counters to a CPM card, where sFlow UDP datagrams are created, sequenced with the CPM sequence number and sent to the receiver. If no UDP sockets are configured, no errors are generated because data is not sent. If no UDP sockets are reachable, the created UDP sFlow datagrams are dropped.



Note: Line cards reset the counter record sequence numbers if, as a result of configuration or operational change, the return statistics no longer provide continuity with the previous interval. This may occur when:

- The card hard or soft resets.
- The MDA resets.
- The sFlow agent counter map changes.

The CPM resets the sFlow datagram sequence numbers if, as a result of configuration or operational change, the sFlow datagram to be sent no longer provides continuity with the previous datagram. The following lists examples of when this takes place:

- HA switch
- CTL reboot
- creation of an sFlow receiver

10.2.2 sFlow support on logical Ethernet ports

sFlow data sources operate in a context of physical Ethernet port. To enable sFlow on Ethernet logical ports and their SAPs, an operator must explicitly enable sFlow on every physical Ethernet port that is a member of the specific logical port. Currently only LAG logical ports are supported (including MC-LAG).



Note: sFlow configuration does not change automatically when a port is added or removed to or from a LAG.

For SAPs on a LAG, egress statistics increment based on ports used by each SAP on LAG egress while ingress statistics increment based on ports used by each SAP on LAG ingress unless LAG features like, for example, per-fp-ingress-queuing or per-fp-sap-optimization result in SAP statistics collection against a single LAG port.

If logical-level view is required, for example, per LAG statistics, a receiver is expected to perform data correlation based on per-physical port interface and SAP records exported for the logical port's physical ports and their SAPs. sFlow data records contain information that allows physical ports/SAP records correlation to a logical port. See [sFlow record formats](#).



Note: Correlation of records must allow for small difference in timestamp values returned for member ports or SAP on a LAG because all ports run independent timestamps.

10.2.3 sFlow SAP counter map

To allow per SAP sFlow statistics export, operators must configure ingress and egress sFlow counter maps. The counter maps are required, because SR OS systems support more granular per policer/

queue counters and not IF-MIB counters per VLL/VPLS SAPs. In an absence of a map configured, 0's are returned in corresponding statistics records.

A single ingress and a single egress counter map are supported. The maps specify which ingress and which egress SAP QoS policy queue/policer statistics map to sFlow unicast, multicast, and broadcast counters returned in an sFlow SAP record. Multiple queues and/or policers can map to each of unicast, multicast, broadcast counters. A single queue/policer can only map to one type of traffic. Queues, policers configured in a SAP QoS policy but not configured in an sFlow map or the other way around are ignored when sFlow statistics are collected.

10.2.4 sFlow record formats

[Table 53: sFlow record fields](#) describes sFlow record used and exported:

Table 53: sFlow record fields

| Record | Field | Value |
|---|-------------------|--|
| sFlow Datagram Header (SAP and port) | Datagram version | 5 |
| | Agent Address | Active CPM IPv4 address (from BoF) |
| | Sub-agent ID | 0 |
| | Sequence number | CPM inserted sFlow datagram sequence number |
| | SysUptime | SysUptime when the counters for records included in the datagram were collected by the line card |
| | NumSamples | Number of counter records in the datagram |
| Counter header (SAP and Port) | Enterprise | 0 (standard sFlow) |
| | sFlow Sample Type | 4 (Expanded counter sample) |
| | Sample Length | sFlow packet size excluding header |
| | Sequence number | Line card-inserted sequence number |
| | Source ID Type | 0 |
| | Source ID Index | tmnxPortId of the physical port (sFlow data source) |
| | Counter records | Count of counter records in the datagram |
| Ethernet Interface Counters (EIC) – port (Ethernet Layer) | Enterprise | Statistics returned are based on dot3Stats Entry in EtherLike-MIB.mib. Statistics support may depend on hardware type. |
| | Format | |
| | Flow data length | |

| Record | Field | Value |
|---|------------------------------|---|
| | Alignment Errors | |
| | FCS Errors | |
| | Single Collision Frames | |
| | Multiple Collision Frames | |
| | SQE Test Errors | |
| | Deferred Transmissions | |
| | Late Collisions | |
| | Excessive Collisions | |
| | Internal Mac Transmit Errors | |
| | Carrier Sense Errors | |
| | Frame Too Longs | |
| | Internal Mac Receive Errors | |
| | Symbol Errors | |
| Generic Interface Counters (GIC) – port/SAP | Enterprise | 0 (standard sFlow) |
| | Format | 1 (GIC) |
| | Flow data length | 88 |
| | ifIndex | Port: ifIndex (tmnxPortId) of phys port SAP: SapEncapValue - part of SAP SNMP key |
| | ifType | Port: 6 (EthernetCsmacd) SAP: 1 (Other) |
| | ifSpeed | Port: Port speed value SAP: <ul style="list-style-type: none"> • top 32 bits: svclId for SAP (TIMETRA-SAP.mib) • lower 32 bits: sapPortId (TIMETRA-SAP.mib) |

| Record | Field | Value |
|---|--------------------------------|--|
| | | The values plus ifIndex in the record are SAP SNMP key. SapPortId is LAG's tmnxPortId for SAPs on a LAG and port's tmnxPortId for SAPs on physical port |
| | ifDirection | Derived from MAU MIB (0 = unknown, 1 = full duplex, 2 = half duplex, 3 = in, 4 = out) |
| | ifAdminStatus | 0 (down) 1 (up) |
| | ifOperStatus | 0 (down) 1 (up) |
| | Input Octets | Statistics return for port are based on ifEntry or ifXEntry in IF-MIB.mib as applicable. Statistics returned for SAPs are sum of counters based on the sFlow ingress/egress counter map configured. |
| | Input Packets | |
| | Input Multicast packets | |
| | Input Broadcast packets | |
| | Input Discarded packets | |
| Generic Interface Counters (GIC) – port/SAP (Continued) | Input Errors | Statistics return for port are based on ifEntry or ifXEntry in IF-MIB.mib as applicable. |
| | Input Unknown Protocol Packets | |
| | Output Octets | Statistics returned for SAPs are sum of counters based on the sFlow ingress/egress counter map configured. |
| | Output Packets | |
| | Output Multicast packets | |
| | Output Broadcast packets | |
| | Output Discarded packets | |
| | Output Errors | |
| | Promiscuous Mode | |

**Note:**

- 0 is returned for statistics that are not supported by a specific hardware type.
- If required, CPM executes rollover logic to convert internal 64-bit counters to a 32-bit sFlow counter returned.

11 gRPC

gRPC is a modern, open-source, high-performance RPC framework that runs in any environment. In SR OS, this framework is used to implement the gRPC server, which can then be used for configuration management or telemetry.

The gRPC transport service uses HTTP/2 bidirectional streaming between the gRPC client (the data collector) and the gRPC server (the SR OS device). A gRPC session is a single connection from the gRPC client to the gRPC server over the TCP/TLS port.

The gRPC service runs on port 57400 by default in SR OS. Use the following command to configure the TCP listening port, if required.

```
configure system grpc listening-port
```

A single gRPC server supports concurrent gRPC sessions and channels.

- There is a maximum of eight concurrent gRPC sessions for all of the gRPC clients.
- There is a maximum of 225 concurrent gRPC channels for all of the gRPC clients.

[Figure 25: Protocol stack](#) shows the gRPC protocol stack.

Figure 25: Protocol stack

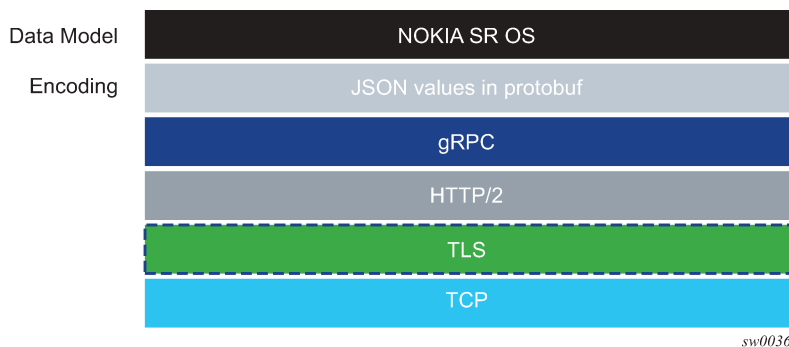

11.1 Security aspects

11.1.1 TLS-based encryption

The gRPC server on SR OS can operate in the following modes:

- without TLS encryption
- with TLS encryption

TLS encryption is used for added security; however, TLS encryption can be disabled in lab environments.

If TLS is not enabled, gRPC messages are not encrypted and usernames and passwords required in gRPC communication are visible to anyone capturing the packets. Therefore, Nokia recommends disabling TLS encryption only in a closed environment.

Before a gRPC connection comes up without TLS, the following conditions must be met:

- no TLS server profile is assigned to the gRPC server
- the following command is configured

```
configure system grpc allow-unsecure-connection
```

The following summarizes the process to use TLS encryption:

- The gRPC session must be in an encrypted state.
- If the gRPC client and gRPC server are unable to negotiate an encrypted gRPC session, the gRPC session fails and the gRPC server sends an error.
- Fallback from an encrypted to an unencrypted gRPC session is not allowed.

For information about how to configure TLS with gRPC, see the TLS chapter.



Note: SR OS TLS supports both ALPN and NPN, which are defined in RFC 7301. For any SR OS TLS server or client profile, SR OS TLS handshake always offers ALPN first, and offers NPN only if the gNMI client does not support ALPN. Consequently, no specific configurations are needed in SR OS to enable or disable ALPN or NPN extensions. For gNMI clients that use ALPN, SR OS verifies the specified HTTP2 ID and port (if needed) before replying to the gNMI client with the same HTTP2 ID and port. For gNMI clients that use NPN, SR OS retains NPN support for backward compatibility.

11.1.2 Certificate revocation check with TLS

For TLS, the following command option is supported for a Certificate Authority (CA) certificate:

```
configure system security pki ca-profile revocation-check crl-optional
```

The optional configuration can be extended for end entity (EE) certificates using the following command (the default value is **revoked**). This command applies when the revocation status of a certificate cannot be determined because of an invalid CRL. A CRL can be invalid because it is missing, expired, or corrupted.

```
configure system security tls client-tls-profile status-verify default-result
```



Note: For safety, the configuration for EE certificates is set to **default-result revoked**. An expired CRL in the CA profile that is matched as the issuer of the EE certificate results in the EE certificate being configured as **revoked**. If the expired CRL is further up in the certificate chain, the **revocation-check crl-optional** command option works as expected.

The **status-verify** command allows users to override the recommended revocation check policy, when applicable.

See [Certificate revocation check](#) for more information.

11.1.3 Authentication

The gRPC users can be authenticated using the local user database, RADIUS, or TACACS+.

When using the local user database, the **access grpc** statement must be included in the user configuration.

- **RADIUS**

Use the following commands to configure the **access grpc** statement and ensure that **radius use-default-template** is enabled (or the RADIUS server must send the Timetra-Access VSA with a value that includes gRPC access):

- **MD-CLI**

```
configure system security aaa user-template user-template-name radius-default
configure system security aaa user-template access grpc true
configure system security aaa remote-servers radius use-default-template
```

- **classic CLI**

```
configure system security user-template radius_default
configure system security user-template access grpc
configure system security radius use-default-template
```

- **TACACS+**

Use the following commands to configure the **access grpc** statement and ensure that **tacplus use-default-template** is enabled:

- **MD-CLI**

```
configure system security aaa user-template user-template-name tacplus-default
configure system security aaa user-template access grpc true
configure system security aaa remote-servers tacplus use-default-template
```

- **classic CLI**

```
configure system security user-template tacplus_default
configure system security user-template access grpc
configure system security tacplus use-default-template
```

User authentication is based on following principles:

- Each RPC sent by the gRPC client carries a username and password.
- For the first RPC in the gRPC session, the gRPC server tries to authenticate the user using the specified authentication order, such as using the local user database, RADIUS, or TACACS+. For example, if TACACS+ is first in the authentication order, the gRPC server sends a request to the TACACS+ server to authenticate the gRPC user.
- For the subsequent RPCs on that same authenticated gRPC session, the username and password are re-authenticated only if changed.
- When no username and password are provided with the RPC, the gRPC server returns an error.
- If the RPC user is changed, any active subscriber RPCs on that same gRPC session are terminated by the gRPC server.
- If the RPC password is changed, the active gRPC session continues to exist until a different username and password is sent in a subsequent RPC, or the gRPC session is terminated.

- Each message is carried over a gRPC session that was previously encrypted; the session is not re-encrypted.

SR OS device authentication is based on the following principles:

- The gRPC clients do not share gRPC sessions. Each gRPC client starts a separate gRPC session.
- When a gRPC session is established, the gRPC server certificates are verified by the gRPC client to ensure that every gRPC server is authenticated by the gRPC client.
- If gRPC is shut down on the gRPC server and a gRPC client is trying to establish a gRPC session, the gRPC client gets an error for every RPC sent.
- If gRPC is shut down on the gRPC server and a gRPC session is established, all active RPCs are gracefully terminated and an error is returned for every active RPC.

11.2 gNMI service

The gRPC Network Management Interface (gNMI) is a gRPC based protocol for network management functions, such as changing the configuration of network elements and retrieving state information. In addition, gNMI provides functionality necessary for supporting telemetry. The gNMI service is specified in the OpenConfig forum.

11.2.1 gNMI service definitions

The SR OS gRPC server supports gNMI version 0.7.0, and in particular, the following RPC operations:

- Capability RPC
- Set/Get RPCs
- Subscribe RPC

As in NETCONF RPCs, gNMI RPCs that are sent to the SR OS system are logged in security log and they are marked as authorized or unauthorized, and include information such as username, time, RPC type, and IP address of the client.

11.2.1.1 Capability discovery

In gNMI service, the client discovers the capabilities of the gRPC server through a Capability-Discovery RPC, which consists of "CapabilityRequest" and "CapabilityResponse" messages.

During this message exchange, the gRPC server informs the client about following attributes:

- supported gNMI version
- supported models
- supported encodings

The SR OS server announces the supported models based on the configuration in the following context.

```
configure system management-interface yang-modules
```

The supported models includes the Nokia YANG or OpenConfig (OC) models.

The advertised module names and organizations are as follows:

- nokia-conf, org = "Nokia"
- nokia-state, org = "Nokia"
- openconfig, org = "OpenConfig working group" (as specified by the 'organization' in the YANG models)
- version - the version number is be defined as follows:
 - for Nokia YANG models, the version number corresponds to an SR OS release number, for example, "16.0.R1"
 - for OC YANG models, the version number corresponds to a version number defined in "oc-ext:openconfig-version" that is included in the respective YANG models
 - for OC-YANG models, including Nokia deviations, the version number corresponds to an SR OS release number, for example, "16.0.R1"

The following is an example of a "Capabilities Response Message":

```
Going to send message of type gnmi.CapabilityResponse:
.gnmi_version: 0.4.0
.supported_encodings (1):
.encoding: 0 = JSON
.supported_models (47):
{ .name: 'nokia-conf', .organization: 'Nokia', .version: '16.0.R1' }
{ .name: 'nokia-state', .organization: 'Nokia', .version: '16.0.R1' }
{ .name: 'openconfig-
bgp', .organization: 'OpenConfig working group', .version: '4.0.1' }
<snip>
{ .name: 'nokia-sr-openconfig-if-ethernet-deviations', .organization: 'Nokia',
.version: '16.0.R1' }
{ .name: 'nokia-sr-openconfig-if[[-ip-deviations', .organization: 'Nokia',
.version: '16.0.R1'...'}
```

11.2.1.2 Get/Set RPC

Information is retrieved from the NE using GET RPC messages, which consists of "GetRequest" and "GetResponse" messages. The client asks for information by specifying following:

- **a set of paths**
All rules to a path definition apply, as specified in the gNMI specification.
- **type**
This refers to configuration, state, or operational data.
- **encoding**
In accordance to server advertisement during capability discovery.
- **use_models**
This message is ignored.

There is an upper limit on the size of the "GetResponse" message. This limit cannot exceed 100MB. If the limit is exceeded, the SR OS gRPC server responds with an error message.

To modify the information in an NE element, a SET gRPC message is used. This gRPC supports three types of transactions:

- delete

- replace
- update

With a gNMI SET RPC, SR OS authorizes all configuration changes, that is, it checks the YANG tree and authorizes every changed element.

The deletion of a container results in the deletion of any children containers that are authorized for deletion as well as their contents. Children containers that are not authorized for deletion, as well as their contents, are retained. For example, upon deletion of **configure system**, **configure system security** is not deleted because the deletion of that child container is not authorized.



Note: Only changes to configuration values are checked for authorization. A configuration command that simply writes the same value to a leaf succeeds even if the user does not have access to that leaf (but there is no resulting change to the configuration). For example, when a user is not authorized to change **access li**, but attempts to change it for another user who already has **access li**, SR OS allows that action because there is no change in value.

11.2.1.3 Subscribe RPC

The subscribe RPC is part of the telemetry support in gNMI.

The gRPC client initiates a subscription by sending a Subscribe RPC that contains a "SubscribeRequest" message to the gRPC server. A prefix can be specified in the "SubscribeRequest". If a prefix is present, it is appended to the start of every path to provide a full path.

A subscription contains the following:

- a list of one or more paths with the following conditions:
 - A path represents the data tree as a series of repeated strings and elements. Each element represents a data tree node name and its associated attributes.
 - A path must be syntactically valid within the set of schema modules that the gRPC server supports.
 - The path list cannot be modified during the lifetime of the subscription.
 - If the subscription path is to a container node, all child leafs of that container node are subscribed to.
 - Any specified path must be unique within the list; paths cannot be repeated within the list. An error is returned if the same path is used more than once in a single subscription.
 - A specified path does not need to pre-exist within the current data tree on the gRPC server. If a path does not exist, the gRPC server continues to monitor for the existence of the path. Assuming that the path exists, the gRPC server transmits telemetry updates.
 - The gRPC server does not send any data for a non-existent path; for example, if a path is non-existent at the time of subscription creation or if the path was deleted after the subscription was established.
 - The maximum number of paths for all subscriptions on a single SR OS device is 14400. A path using a wildcard is still considered a single path.
- an encoding with the following supported options:
 - JSON
 - JSON-IETF
 - BYTES

– PROTO

The following command affects PROTO and BYTES encoding.

```
configure system grpc gnmi proto-version
```

If the command option is **latest**, the encodings are interpreted as defined in specification v0.8.0. The following table lists the summary of different encoding options and the values used based on the **proto-version** command for all possible values defined in the gnmi.proto OpenConfig module.

Table 54: Options for the proto-version command

| Response field | JSON | JSON-IETF | PROTO | BYTES |
|---|------|-----------|--------|--------|
| string string_val = 1; | | | latest | v0.7.0 |
| int64 int_val = 2; | | | latest | v0.7.0 |
| uint64 uint_val = 3; | | | latest | v0.7.0 |
| bool bool_val = 4; | | | latest | v0.7.0 |
| bytes bytes_val = 5; | | | latest | v0.7.0 |
| float float_val=6 [deprecated=true]; / / Deprecated - use double_val. | | | | |
| Decimal64 decimal_val = 7 [deprecated=true]; / / Deprecated - use double_val. | | | | v0.7.0 |
| ScalarArray leaflist_val = 8; | | | latest | |
| google.protobuf.Any any_val = 9; | | | | |
| bytes json_val = 10; | x | | | |
| bytes json_ietf_val = 11; | | x | | |
| string ascii_val = 12; | | | | |
| bytes proto_bytes = 13; | | | v0.7.0 | latest |
| double double_val= 14; | | | latest | |

- a subscription mode of one of the following types:
 - **ONCE mode**
The server returns only one notification containing all the information to which the client has subscribed. In general, use telemetry to retrieve large amounts of information from the NE: "SubscribeRequest" message with ONCE subscription type.
 - **ON_CHANGE mode**
The server returns notifications only when the value of the subscribed field changes. See [ON_CHANGE subscription mode](#) for more information.
 - **SAMPLE mode**
The gRPC server sends notifications at the specified sampling interval.
 - **TARGET_DEFINED mode**
This refers to ON_CHANGE for all states supporting ON_CHANGE notifications and SAMPLE mode for all other objects in the YANG tree.
- a sample interval for each path
 - If a sample interval of less than 1 s is specified, the gRPC server returns an error.
 - If the sample interval is set to 0, the default value of 10 s is used.
 - A sample interval is specified in nanoseconds (10 000 000 000 by default)

When a subscription is successfully initiated on the gRPC server, "SubscribeResponse" messages are sent from the gRPC server to the gRPC client. The "SubscribeResponse" message contains update notifications about the subscription's path list.

An update notification contains:

- a timestamp of the statistics collection time, represented in nanoseconds
- a prefix
 - If a prefix is present, it is logically appended to the start of every path to provide the full path.
 - The presence of a prefix in the "SubscribeResponse" message is not related to the presence of a prefix in the original "SubscribeRequest" message. The prefix in the "SubscribeResponse" message is optimized by the gRPC server.
- a list of updates (path and value pairs)
 - A path represents the data tree path as a series of repeated strings or elements, where each element represents a data tree node name and its associated attributes. See [Schema paths](#) for more information.
 - The "TypedValue" message represents the value of the data tree node, where the encoding is "JSON", "JSON_IETF", "Bytes", or "Protobuf" depending on the information in the "SubscribeRequest" message.

Multiple notification messages can be combined in a single "SubscribeResponse" message. This bundling minimizes overhead, which improves the efficiency of telemetry data transport, however, this may delay some notifications and timestamps may be less accurate. The following options control message bundling:

max-time-granularity

controls the maximum time during which notifications can be bundled

max-msg-count

controls the maximum number of notifications that can be bundled

A sync response notification is sent one time after the gRPC server sends all updates for the subscribed-to paths. The sync response must be set to "true" for the gRPC client to consider that the stream has synced one time. A sync response is used to signal the gRPC client that it has a full view of the subscribed-to data.

The gRPC server sends an error, if required. The error contains a description of the problem.

Authorization checks are not performed by default for telemetry data. All configuration and state elements are available to authenticated telemetry subscriptions, with the exception of LI (Lawful Intercept) configuration and state elements, which are authorized separately based on the LI authorization configuration.

Use the following command to control telemetry data authorization:

- **MD-CLI**

```
configure system security aaa management-interface output-authorization telemetry-data
```

- **classic CLI**

```
configure system security management-interface output-authorization telemetry-data
```

11.2.1.3.1 PROTO encoding

PROTO encoding is performed by the gRPC server, which encodes the values of the leafs as typed values. [Table 55: Mapping of YANG types to gNMI-specified typed values](#) lists the mapping of the individual YANG types to the typed values defined in the gNMI specification (v0.8.0) in the GitHub repository.

Table 55: Mapping of YANG types to gNMI-specified typed values

| YANG type | Typed value |
|---------------------|-------------|
| binary | bytes_val |
| bits | string_val |
| boolean | bool_val |
| decimal64 | double_val |
| empty | bool_val |
| enumeration | string_val |
| identityref | string_val |
| instance-identifier | string_val |
| int8 | int_val |
| int16 | int_val |
| int32 | int_val |
| int64 | int_val |

| YANG type | Typed value |
|-----------|-----------------------------|
| leafref | type of referenced leaf |
| string | string_val |
| uint8 | uint_val |
| uint16 | uint_val |
| uint32 | uint_val |
| uint64 | uint_val |
| union | type of active union member |

11.2.1.3.2 BYTES encoding

The BYTES encoding mechanism uses the binary encoding format for both path and value to increase the efficiency of telemetry data transfer. The YANG files are encoded in protobuf format, in which every possible path is encoded as a binary index.

The protobuf encoded YANG files are distributed together with the SR OS software or found on <http://github.com> under Nokia 7X50_protobufs. The PROTO definitions of the YANG model are specifically generated for each software release; backward compatibility is not supported.

To retrieve decoding information for PROTO encoding, the gNMI client can use GetRPC to request a path with origin "gnmi.schemas". The path must be either a root path "gnmi.schemas:/", or a specific path, for example, "gnmi.schemas:/protobuf-typemap", as described in *protobuf-vals.md* published on github.com (May 2018).

The following example shows the GetRPC request and SR OS response:

```
Received message of type gnmi.GetRequest:
.type: 0 = ALL
.encoding: 4 = JSON_IETF
.prefix: /
.path (1):
  .path: gnmi.schemas:/
"

Going to send message of type gnmi.GetResponse:
.notification (1):
  .timestamp: 1616677860728392525
  .update (1):
    .path: gnmi.schemas:/protobuf-typemap
    .val.value = json_ietf_val: {
      "gnmi-protobuf-encoding:origin": [
        {
          "name": "",
          "container": [
            {
              "path": "/",
              "message-name": "proto.nokia.net/Nokia.SROS.root"
            }
          ]
        }
      ]
    }
  }
```

11.2.1.3.3 ON_CHANGE subscription mode

SR OS supports ON_CHANGE subscription mode. This subscription mode indicates that Notification messages are sent as follows:

- after the "SubscriptionRequest" message is received
- every time the corresponding leaf value is changed

The notification message, as a response to an ON_CHANGE subscription, always contains the new value of the corresponding leaf, as defined in gNMI specification.

The ON_CHANGE subscription is supported for all configuration leafs as well as for selected state leafs. Use the following command to display all state leafs supporting the ON_CHANGE subscription.

```
tools dump system telemetry on-change-paths
```

ON_CHANGE subscription is accepted for all valid paths. The server sends ON_CHANGE notifications only for leafs within the specified subtree that support ON_CHANGE notifications.

11.2.1.4 Publish RPC

With dial-out telemetry, where the SR OS node is the gRPC client instead of the gRPC server, the SR OS node sends a Publish RPC with a "SubscribeResponse" message to the gRPC server. (See [Dial-out telemetry](#).)

Because the current gnmi.proto definition does not support dial-out mode, a protobuf definition is introduced, with a separate gRPC service, as follows:

```
NOKIA-DialOut.proto
option (dialout_service) = 0.1.0
service gMIDialOut {
    rpc Publish(stream SubscribeResponse) returns (stream PublishResponse)
}
message PublishResponse {
}
```

The preceding proto file definition reuses the "SubscribeResponse" message defined for dial-in telemetry, in accordance with the gNMI specification.

11.2.1.5 Schema paths

Telemetry subscriptions include a set of schema paths used to identify which data nodes are of interest to the collector.

The paths in Telemetry Subscribe RPC requests follow the conventions described in the *OpenConfig gnmi-path-conventions.md* published on github.com (version 0.4.0, published June 21, 2017).

A path consists of a set of path segments often shown with a "/" character as a delimiter; for example, /configure/router[router-instance=Base]/interface[interface-name=my-interface1]/description.

These paths are encoded as a set of individual string segments in gnmi.proto (without any "/" characters); for example, ["configure", "router[router-name=Base]", "interface[interface-name=my-interface1]", "description"].

A path selects an entire subtree of the data model and includes all descendants of the node indicated in the path. [Table 56: Schema paths](#) describes the types of schema paths that are supported in SR OS telemetry.

Table 56: Schema paths

| Path example | Description |
|---|--|
| /configure/router[router-name=Base]/interface[interface-name=abc] | Selects all config leafs of interface abc and all descendants. |
| /configure/router[router-name=Base]/interface[interface-name=abc]/description | Selects only the description leaf of interface abc. |
| /state/router[router-name=Base]/interface[interface-name=*] | Selects all state information for all base router interfaces using a wildcard in a single segment of a path. |
| /configure/router[router-name=Base]/interface[interface-name=*/description | Selects only the description leaf of all interfaces. |
| /configure/router[router-name=Base]/interface/description | Applies to all RPCs. Selects the entire list to account for absent list keys. It is equivalent to /configure/router[router-name=Base]/interface[interface-name=*/description |
| / | The root path. This selects all config and state data from all models (in all namespaces) supported on the router. Encoded as "" in gRPC/gPB. |
| /state/... | Not supported. Equivalent to /state/ |
| /* | Expands one level of a subtree schema. |

The following list describes the telemetry paths support in SR OS.

- The following wildcards are supported in the schema:
 - Specifying “/...” wildcard expands to multiple element levels in a path.
 - Specifying “/*” wildcard expands to only one level in a path.
- Wildcards for entire path segments are supported as follows:
 - For example: “/state/card/.../oper-state” expands to following paths
 - /state/card[slot-number=*/hardware-data/oper-state
 - /state/card[slot-number=*/mda[mda-slot=*/hardware-data/oper-state
 - /state/card[slot-number=*/mda[mda-slot=*/flex[group-index=*/oper-state
 - For example: “/state/card/*/oper-state” expands to following path
 - /state/card[slot-number=*/hardware-data/oper-state

- If a wildcard is used for any key of a list, a wildcard must be used for all the keys of that list. In a single path segment, all keys must either have specific values or all keys must have wildcards. A mix of wildcards and specific values for different parts of a list key is not supported. For example:

Supported:

```
/a/b[key1=*][key2=*]/c[key1=foo]
```

```
/a/b[key1=foo][key2=bar]/c[key1=*]
```

Not supported:

```
/a/b[key1=foo][key2=*]
```

- Functions such as "current()", "last()" and mathematical operators, such as `stat<5` or `octets>3` are not supported in paths. The "|" (OR operator, used to select multiple paths) is not supported.
- Wildcards in multiple segments of a path are supported.

For example: `/state/card[slot-number=*]/mda[mda-slot=*]`

- The paths with wildcards are expanded when a subscription is activated; this applies to dynamic and persistent subscriptions. In some cases, it is possible that a single path with wild cards can be expanded across both Nokia and Openconfig YANG models. However, this occurs only if both model types are enabled. If only one type is enabled, the path is expanded only within the enabled model. If the other type is enabled later, it is necessary to reset all subscriptions, which ensures that the expansion includes the newly enabled model type.

11.2.2 gNMI service use cases

The gNMI Service can be used for the following:

- Telemetry
- NE Configuration Management

11.2.2.1 Telemetry

Telemetry is a network monitoring and fault management framework. Telemetry is driven by the need to use fresh data obtained from the network to make fast networking decisions such as traffic optimization and preventive troubleshooting.

11.2.2.1.1 Dial-in telemetry

When the data collector initiates the gRPC connection, the SR OS node assumes the role of the gRPC server and the collector is the client. This is referred to as dial-in telemetry, where the SR OS node pushes data to the receiver (collector). [Figure 26: Dial-in telemetry session](#) shows the telemetry session initiated from the collector to the SR OS node via the Subscribe RPC.

Figure 26: Dial-in telemetry session

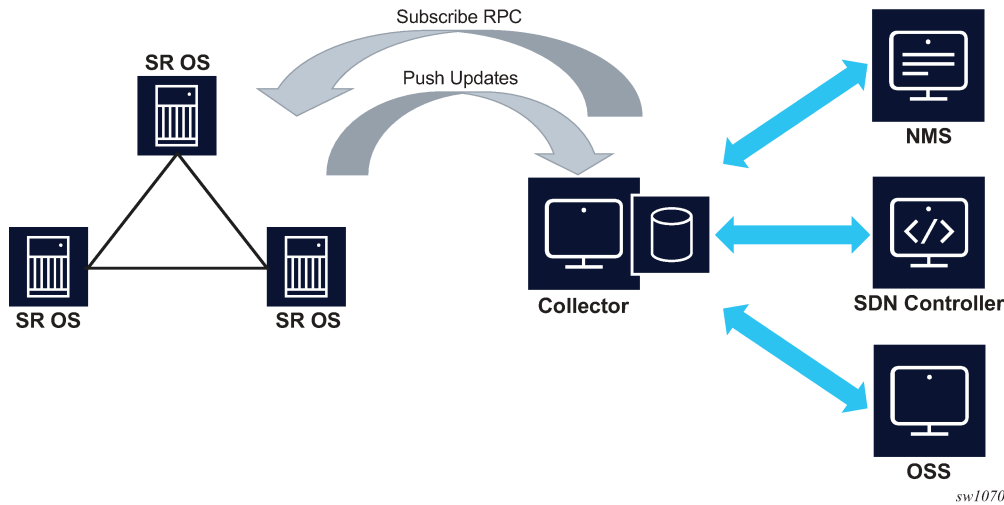

11.2.2.1.1.1 Dynamic subscriptions

Dynamic subscriptions are created by the collector using the Subscribe RPC. These subscriptions are removed as soon as the gRPC session terminates. Dynamic subscriptions are currently supported only in dial-in mode.

11.2.2.1.1.2 Dial-in telemetry examples

This section contains examples of telemetry subscription requests and responses. The following examples are dumps of protobuf messages from a Python API. Formats may vary across different implementations.

Example 1: Subscribe to a single path

```
2017-06-05 17:06:13,189 - SENT::SubscribeRequest
subscribe {
  subscription {
    path {
      element: "state"
      element: "router[router-instance=Base]"
      element: "interface[interface-name=test]"
      element: "statistics"
      element: "ip"
      element: "in-packets"
    }
    mode: SAMPLE
    sample_interval: 10000000000
  }
}
```

```
2017-06-05 17:06:13,190 - RCVD::SubscribeResponse
2017-06-05 17:06:23,492 - RCVD::Subscribe
2017-06-05 17:06:23,492 - update {
  timestamp: 1496675183491595139
  prefix {
    element: "state"
```

```

    element: "router[router-instance=Base]"
    element: "interface[interface-name=test]"
    element: "statistics"
    element: "ip"
  }
  update {
    path {
      element: "in-packets"
    }
    val {
      json_val: ""0""
    }
  }
}
2017-06-05 17:06:23,494 - RCVD::Subscribe
2017-06-05 17:06:23,494 - sync_response: true

```

```

2017-06-05 17:06:33,589 - RCVD::Subscribe
2017-06-05 17:06:33,589 - update {
  timestamp: 1496675213491595139
  prefix {
    element: "state"
    element: "router[router-instance=Base]"
    element: "interface[interface-name=test]"
    element: "statistics"
    element: "ip"
  }
  update {
    path {
      element: "in-packets"
    }
    val {
      json_val: ""28""
    }
  }
}
....
....

```

Example 2: Subscribe to a single path with wildcard

```

2017-06-05 17:08:29,055 - SENT::SubscribeRequest
subscribe {
  subscription {
    path {
      element: "state"
      element: "router[router-instance=Base]"
      element: "interface[interface-name=*]"
      element: "statistics"
      element: "ip"
      element: "in-packets"
    }
    mode: SAMPLE
    sample_interval: 30000000000
  }
}

```

```

2017-06-05 17:08:29,056 - RCVD::SubscribeResponse
2017-06-05 17:08:59,133 - RCVD::Subscribe
2017-06-05 17:08:59,133 - update {
  timestamp: 1496675339132056575
  prefix {
    element: "state"
  }
}

```

```

    element: "router[router-instance=Base]"
    element: "interface[interface-name=system]"
    element: "statistics"
    element: "ip"
  }
  update {
    path {
      element: "in-packets"
    }
    val {
      json_val: ""0""
    }
  }
}
2017-06-05 17:08:59,135 - RCVD::Subscribe
2017-06-05 17:08:59,135 - update {
  timestamp: 1496675339133006678
  prefix {
    element: "state"
    element: "router[router-instance=Base]"
    element: "interface[interface-name=to_node_B]"
    element: "statistics"
    element: "ip"
  }
  update {
    path {
      element: "in-packets"
    }
    val {
      json_val: ""0""
    }
  }
}
2017-06-05 17:08:59,135 - RCVD::Subscribe
2017-06-05 17:08:59,135 - update {
  timestamp: 1496675339133006678
  prefix {
    element: "state"
    element: "router[router-instance=Base]"
    element: "interface[interface-name=to_node_D]"
    element: "statistics"
    element: "ip"
  }
  update {
    path {
      element: "in-packets"
    }
    val {
      json_val: ""0""
    }
  }
}
2017-06-05 17:08:59,136 - RCVD::Subscribe
2017-06-05 17:08:59,136 - sync_response: true

```

```

2017-06-05 17:09:29,139 - RCVD::Subscribe
2017-06-05 17:09:29,139 - update {
  timestamp: 1496682569121314
  prefix {
    element: "state"
    element: "router[router-instance=Base]"
    element: "interface[interface-name=system]"
    element: "statistics"
  }
}

```

```

    element: "ip"
  }
  update {
    path {
      element: "in-packets"
    }
    val {
      json_val: ""0""
    }
  }
}
2017-06-05 17:09:29,142 - RCVD::Subscribe
2017-06-05 17:09:29,142 - update {
  timestamp: 1496682569124342
  prefix {
    element: "state"
    element: "router[router-instance=Base]"
    element: "interface[interface-name=to_node_B]"
    element: "statistics"
    element: "ip"
  }
  update {
    path {
      element: "in-packets"
    }
    val {
      json_val: ""0""
    }
  }
}
2017-06-05 17:09:29,145 - RCVD::Subscribe
2017-06-05 17:09:29,145 - update {
  timestamp: 1496682569127344
  prefix {
    element: "state"
    element: "router[router-instance=Base]"
    element: "interface[interface-name=to_node_D]"
    element: "statistics"
    element: "ip"
  }
  update {
    path {
      element: "in-packets"
    }
    val {
      json_val: ""0""
    }
  }
}
....
....

```

Example 3: Subscribe to more than one path

```

2017-01-24 12:54:18,228 - SENT::SubscribeRequest
subscribe {
  subscription {
    path {
      element: "state"
      element: "router[router-instance=Base]"
      element: "interface[interface-name=to_node_B]"
    }
  }
  mode: SAMPLE
}

```

```

    sample_interval: 3000000000
  }
  subscription {
    path {
      element: "state"
      element: "router[router-instance=Base]"
      element: "mpls"
      element: "statistics"
      element: "lsp-egress-stats[lsp-name=lsp_to_dest_f]"
    }
    mode: SAMPLE
    sample_interval: 3000000000
  }
}

```

Example 4: Subscribe to a list with wildcard

```

2017-01-24 13:45:30,947 - SENT::SubscribeRequest
subscribe {
  subscription {
    path {
      element: "state"
      element: "router[router-instance=Base]"
      element: "interface[interface-name=*]"
    }
    mode: SAMPLE
    sample_interval: 3000000000
  }
}

```

Example 5: Subscribe to path where the object did not exist before subscription

```

2017-01-24 13:53:50,165 - SENT::SubscribeRequest
subscribe {
  subscription {
    path {
      element: "state"
      element: "router[router-instance=Base]"
      element: "interface[interface-name=to_node_B]"
    }
    mode: SAMPLE
    sample_interval: 3000000000
  }
}

```

```

2017-01-24 13:53:50,166 - RCVD::SubscribeResponse
2017-01-24 13:54:20,169 - RCVD::Subscribe
2017-01-24 13:54:20,169 - sync_response: true

```

```

2017-01-24 13:54:50,174 - RCVD::Subscribe
2017-01-24 13:54:50,174 - update {
  timestamp: 1485262490169309451
  prefix {
    element: "state"
    element: "router[router-instance=Base]"
    element: "interface[interface-name=to_node_B]"
  }
  update {
...
...
}

```

```
}

```

Example 6: Subscribe to a path where the object existed before subscription and then deleted after subscription

```
2017-01-24 14:00:41,292 - SENT::SubscribeRequest
subscribe {
  subscription {
    path {
      element: "state"
      element: "router[router-instance=Base]"
      element: "interface[interface-name=to_node_B]"
    }
    mode: SAMPLE
    sample_interval: 30000000000
  }
}
```

```
2017-01-24 14:00:41,294 - RCVD::SubscribeResponse
2017-01-24 14:01:11,295 - RCVD::Subscribe
2017-01-24 14:01:11,295 - update {
  timestamp: 1485262871290064704
  prefix {
    element: "state"
    element: "router[router-instance=Base]"
    element: "interface[interface-name=to_node_B]"
  }
  update {
  ...
  ...
  }
}
```

```
2017-01-24 14:01:41,293 - RCVD::Subscribe
```

```
2017-01-24 14:02:11,296 - RCVD::Subscribe
```

11.2.2.1.2 Dial-out telemetry

When the SR OS node initiates the gRPC connection, the SR OS node assumes the role of the gRPC client. This is referred to as dial-out telemetry. [Figure 27: Dial-out telemetry session](#) shows the telemetry session initiated from the SR OS node to the collector via a Publish RPC.

Figure 27: Dial-out telemetry session

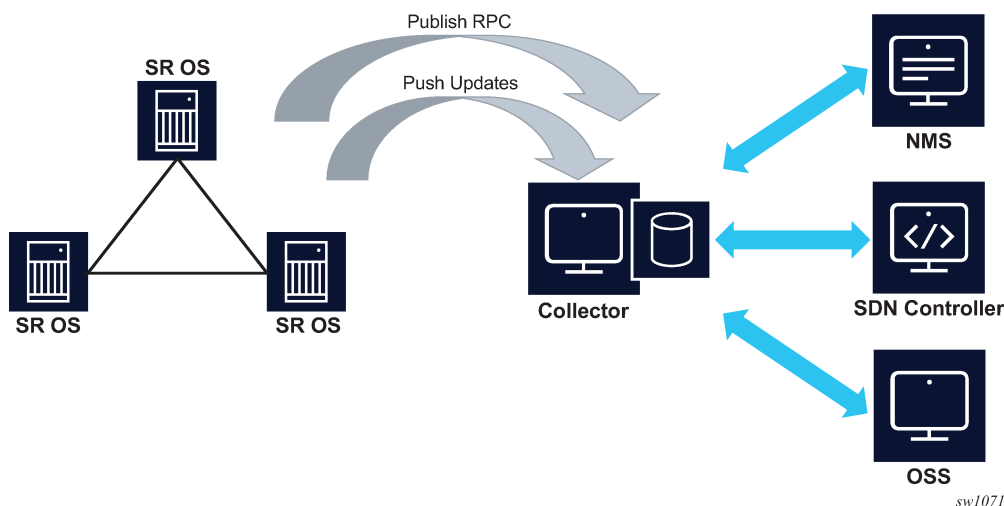

11.2.2.1.2.1 Persistent subscriptions

Persistent subscriptions are configured on the SR OS node and they are not cleared when the gRPC session terminates. Persistent subscriptions are supported only in dial-out mode.

A persistent subscription associates one or more paths with corresponding destinations via sensor groups.

Every subscription has an associated administrative state as well as an operational state. If a connection is lost, the operational state goes down. If the collector does not receive the data but the SR OS appears to have a connection and the subscription is up, the connection can be reset by setting the administrative state down and then back up.

Destinations are defined in the form of destination groups. A destination group supports up to four destinations, where the destinations are served in a round-robin fashion. SR OS attempts to connect the first destination, and if successful, the telemetry data is sent to that destination. If the connection to the first destination fails (initially or during operation), SR OS attempts to connect or reconnect to the second destination, if it is configured. All configured destinations and local addresses should be reachable in the specified routing instances.

When the SR OS node initiates the gRPC connection via the Publish RPC, it includes the subscription name and the configured system name in the metadata. The collector can use this information to associate individual notification messages with the node and subscription.

Modifying any parameter of the active subscription causes the SR OS node to close the gRPC connection before attempting a reconnection.

When a gRPC connection is lost, the SR OS node continually attempts to establish a new session with the collector.

11.2.2.1.2.2 QoS marking

The QoS marking of the IP packets carrying notifications can be configured under persistent subscription. IP packets to a specified destination are marked according to the configuration of the first subscription opened to the destination. This DSCP marking is maintained, regardless of any configuration changes, as

long as the dial-out connection to the specified destination is open. If the destination is disconnected for any reason, the DSCP marking must be redefined when the connection is reestablished.

11.2.2.1.2.3 Configuring dial-out telemetry

The dial-out telemetry configuration process includes the following elements:

| | |
|--------------------------------|---|
| sensor group | specifies one or more schema paths from which data is streamed to the collector |
| destination group | specifies the destination addresses (and ports) that the router uses to send the telemetry data |
| persistent subscription | associates a sensor group with a destination group and specifies streaming options for the telemetry data. For example, the subscription mode can be specified (ON_CHANGE, SAMPLE, or TARGET_DEFINED) for the subscription. |

Dial-out telemetry can be configured via the MD-CLI or the classic CLI. For more information about using the MD-CLI, see the *7450 ESS, 7750 SR, and 7950 XRS MD-CLI User Guide*. For more information about the MD-CLI configuration commands, see the *7450 ESS, 7750 SR, 7950 XRS, and VSR MD-CLI Command Reference Guide*.

For more information about the classic CLI configuration commands, see the *7450 ESS, 7750 SR, 7950 XRS, and VSR Classic CLI Command Reference Guide* and the *7450 ESS, 7750 SR, 7950 XRS, and VSR Clear, Monitor, Show, and Tools Command Reference Guide*.

The following example shows a dial-out telemetry configuration.

Example: MD-CLI

```
[ex:/configure system telemetry]
A:admin@node-2# info
  destination-group "quick_cfg_dg_1" {
    description "Destination Group 1"
    allow-unsecure-connection
    destination 192.168.65.5 port 40001 {
      router-instance "Base"
    }
    destination 192.168.65.5 port 40002 {
      router-instance "Base"
    }
  }
  persistent-subscriptions {
    subscription "quick_cfg_sub_1" {
      admin-state enable
      description "Subscription 1"
      sensor-group "quick_cfg_sg"
      mode sample
      sample-interval 1234
      destination-group "quick_cfg_dg_1"
      local-source-address 1.2.3.4
      originated-qos-marking cp19
      encoding bytes
    }
  }
  sensor-groups {
    sensor-group "quick_cfg_sg" {
      description "Sensor Group"
```

```

        path "/state/router[router-name=Base]/interface[interface-name=test]/
statistics/ip" { }
    }
}

```

Example: classic CLI

```

A:node-2>config>system>telemetry# info
-----
        destination-group "quick_cfg_dg_1" create
        description "Destination Group 1"
        allow-unsecure-connection
        tcp-keepalive
        shutdown
        exit
        destination 192.168.65.6 port 40001 create
        router-instance "Base"
        exit
        destination 192.168.65.5 port 40002 create
        router-instance "Base"
        exit
    exit
    sensor-groups
        sensor-group "quick_cfg_sg" create
        description "Sensor Group"
        path "/state/router[router-name=Base]/interface[interface-name=test]/
statistics/ip" create
        exit
        exit
    exit
    persistent-subscriptions
        subscription "quick_cfg_sub_1" create
        description "Subscription 1"
        destination-group "quick_cfg_dg_1"
        encoding bytes
        mode sample
        sample-interval 1234
        sensor-group "quick_cfg_sg"
        local-source-address 1.2.3.4
        originated-qos-marking "cp19"
        no shutdown
        exit
    exit
-----

```

Use the following command to show telemetry information.

```
show system telemetry persistent subscription "quick_cfg_sub_2"
```

Output example

```

=====
Telemetry persistent subscription
=====
Subscription Name      : quick_cfg_sub_2
Administrative State   : Enabled
Operational State     : Up
Subscription Id       : 198
Description           :
Sensor Group          : quick_cfg_sg_2
Destination Group     : quick_cfg_dg_2
Path Mode             : sample

```

```
Sample Interval      : 1000 ms
Encoding            : bytes
```

Use the following command to show telemetry paths information.

```
show system telemetry persistent subscription "quick_cfg_sub_2" paths
```

Output example

```
=====
Telemetry persistent subscriptionrsistent# subscription "quick_cfg_sub_2" paths
=====
Subscription Name      : quick_cfg_sub_1nt# subscription "quick_cfg_sub_2" paths
Administrative State   : Enabled
Operational State     : Up
Subscription Id        : 198
Description            :
Sensor Group          : quick_cfg_sg_2
Destination Group     : quick_cfg_dg_2
Path Mode              : sample
Sample Interval       : 1000 ms
Encoding              : bytes
-----
Paths
-----
Path                   : /state
Finished Samples      : 178
Deferred Samples      : 402
Total Collection Time : 405223 ms
Min Collection Time   : 2021 ms
Avg Collection Time   : 2276 ms
Max Collection Time   : 2956 ms
-----
No. of paths          : 1
=====

=====
Telemetry persistent subscription
=====
Subscription Name      : quick_cfg_sub_2
Administrative State   : Enabled
Operational State     : Up
Subscription Id        : 198
Description            :
Sensor Group          : quick_cfg_sg_2
Destination Group     : quick_cfg_dg_2
Path Mode              : sample
Sample Interval       : 1000 ms
Encoding              : bytes
-----
Destinations
-----
Destination           : 192.168.65.1
Port                  : 40001
Operational State     : Down
Last Oper Down Reason : MINOR: TELEMETRY #2353: RPC refused by peer
Last Oper Change      : 2020/04/06 21:19:29
Connection Attempts   : 22
Notification Count    : 0
Total Notification Co*: 2315653
-----
```

```

Destination      : 192.168.65.1
Port             : 40002
Operational State : Up
Last Oper Down Reason : MINOR: TELEMETRY #2356: Canceled by config change
Oper Router Instance : management
Last Oper Change  : 2020/04/06 21:19:30
Connection Attempts : 22
Notification Count : 3783151
Total Notification Co* : 5034573
-----
No. of destinations : 2
* indicates that the corresponding row element may have been truncated.
=====

```

11.2.2.2 NE configuration management

Figure 28: NE configuration and information retrieval using gNMI service shows NE configuration and information retrieval using the gNMI service.

Figure 28: NE configuration and information retrieval using gNMI service

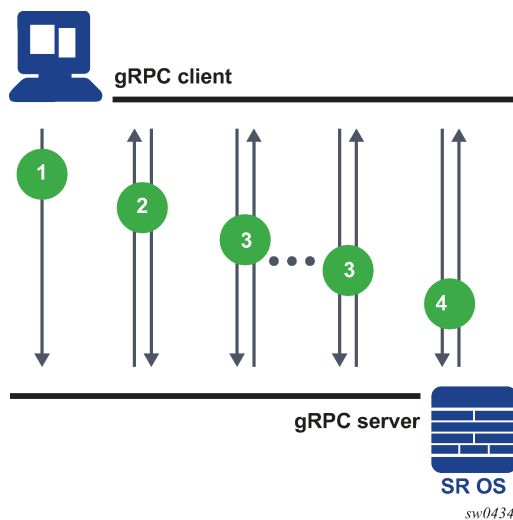

In the context of gNMI, every SET RPC appears as a single commit operation, regardless of the number of paths included in the message. Both, Nokia and OC models are supported by gNMI SET/GET RPC.

An example of the SET RPC command (including the response message from the gRPC server) follows:

```

gNMI_rpc - DEBUG - SENT::SetRequest
prefix {
}
update {
  path {
    elem {
      name: "configure"
    }
    elem {
      name: "system"
    }
  }
}
val {

```

```

    json_val: {"location": "zurich"}
  }
}
gMI_rpc - DEBUG - RCVD::SetResponse
prefix {
}
response {
  path {
    elem {
      name: "configure"
    }
    elem {
      name: "system"
    }
  }
  op: UPDATE
}

```

An example of the GET RPC command (including the response message from the gRPC server) follows:

```

gNMI_rpc - INFO - SENT::GetRequest GET140550212650064
path {
  elem {
    name: "configure"
  }
  elem {
    name: "system"
  }
  elem {
    name: "location"
  }
}
type: CONFIG
2017-12-06 12:17:28,639 - gMI_rpc - INFO -
RCVD::GetResponse GET140550212650064
notification {
  timestamp: 1512559048634751055
  update {
    path {
      elem {
        name: "configure"
      }
      elem {
        name: "system"
      }
      elem {
        name: "location"
      }
    }
  }
  val {
    json_val: "zurich"
  }
}
}

```

11.3 gNOI services

The gRPC Network Operations Interface (gNOI) defines a set of gRPC-based micro-services for executing operational commands on network devices. This includes the gNOI CERT service, that provides certificate

management. The individual RPCs and messages that perform the operations required for certificate management on the node are defined in the Git repository hosting service (GitHub).

11.3.1 Certificate management for TLS connections

This section describes the gNOI services certificates that SR OS supports for managing secure TLS connections.

The SR OS supports the following RPCs for managing certificates for secure TLS connections:

- RPC GetCertificates
- RPC CanGenerateCSR
- RPC Rotate
- RPC Install



Note: By default, the gNOI RPCs are disabled in the user profile.

11.3.1.1 RPC GetCertificates

RPC GetCertificates provide information to the controller about all active certificates on the server (SR OS node). [Figure 29: RPC GetCertificates message flow](#) shows the message sequence.

Figure 29: RPC GetCertificates message flow

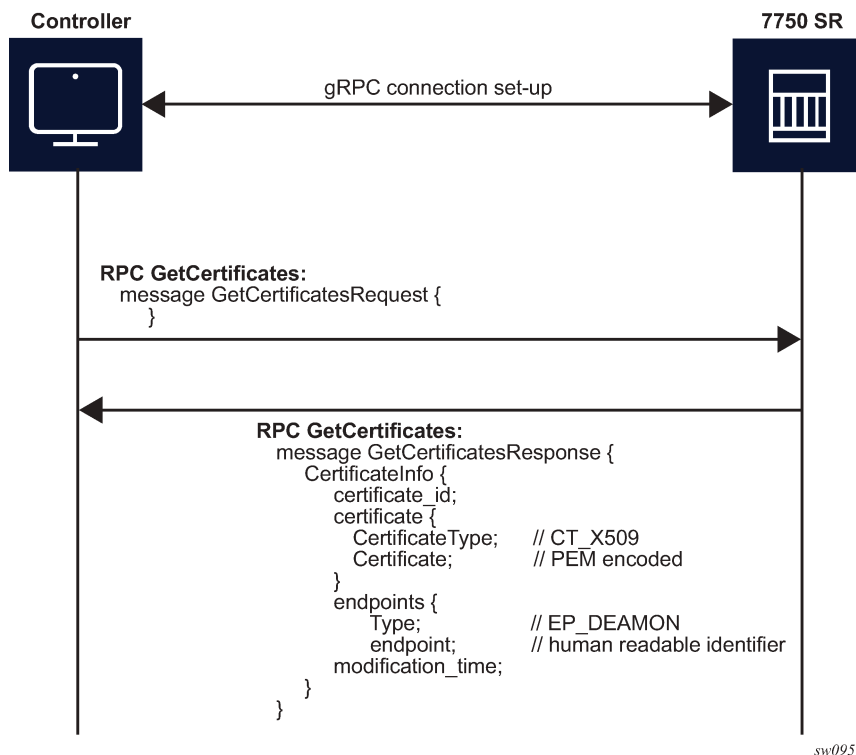

The RPC GetCertificates messages include a GetCertificateRequest and a GetCertificateResponse message. The GetCertificatesResponse message shown in [Figure 29: RPC GetCertificates message flow](#) includes the following information:

- **certificate_id**
The SR OS uses a certificate filename as the certificate ID.
- **CertificateType**
This is always set to X509, because it is the only type that the SR OS supports.
- **endpoint**
This indicates the CERT profiles in the SR OS node that use this certificate; if multiple CERT profiles use the certificate, the names are concatenated with the separation character "/".

11.3.1.2 RPC CanGenerateCSR

The RPC CanGenerateCSR message can be used to determine if the gRPC server (SR OS node) can generate a Certificate Signing Request (CSR). It is a simple request and response operation as shown in [Figure 30: RPC CanGenerateCSR message flow](#).

Figure 30: RPC CanGenerateCSR message flow

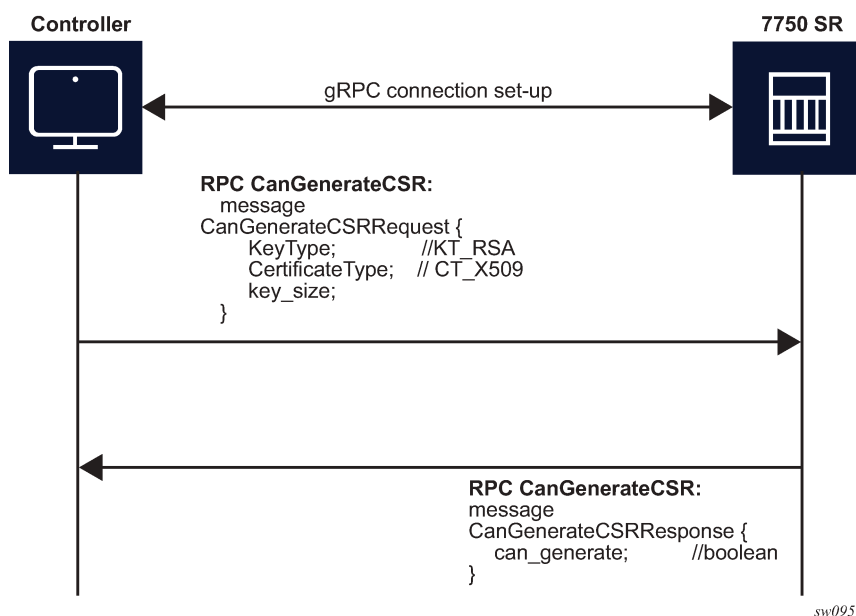

The SR OS only supports RSA keys and X509 certificates, so it only responds positively if those values are filled in the respective fields. The key size must be between 512 and 8192. In all other cases, the SR OS responds negatively to the CanGenerateCSRRequest message.

11.3.1.3 RPC Rotate

RPC Rotate allows the controller to rotate an active certificate on the server. After the rotation is completed, a new certificate can be used without affecting existing TLS connections.

The following cases are supported for a certificate rotation:

- server capable of generating a CSR (see [Figure 31: RPC Rotate message flow for CSRs generated on the SR OS node](#))
- server not capable of generating a CSR (see [Figure 32: RPC Rotate message flow when CSRs are not generated on the SR OS node](#))

The SR OS supports both scenarios, although it is assumed that in most cases the CSR is generated on SR OS node.

The following steps apply to both scenarios:

1. Generate the CSR.
2. Sign the CSR by the Certificate Authority (CA).
3. Load the new certificate on the server.
4. Verify the new certificate by creating a new connection.
5. Finalize by confirming that the new certificate is being used.

After the RPC Rotate is completed, all new connections use new keys.

Figure 31: RPC Rotate message flow for CSRs generated on the SR OS node

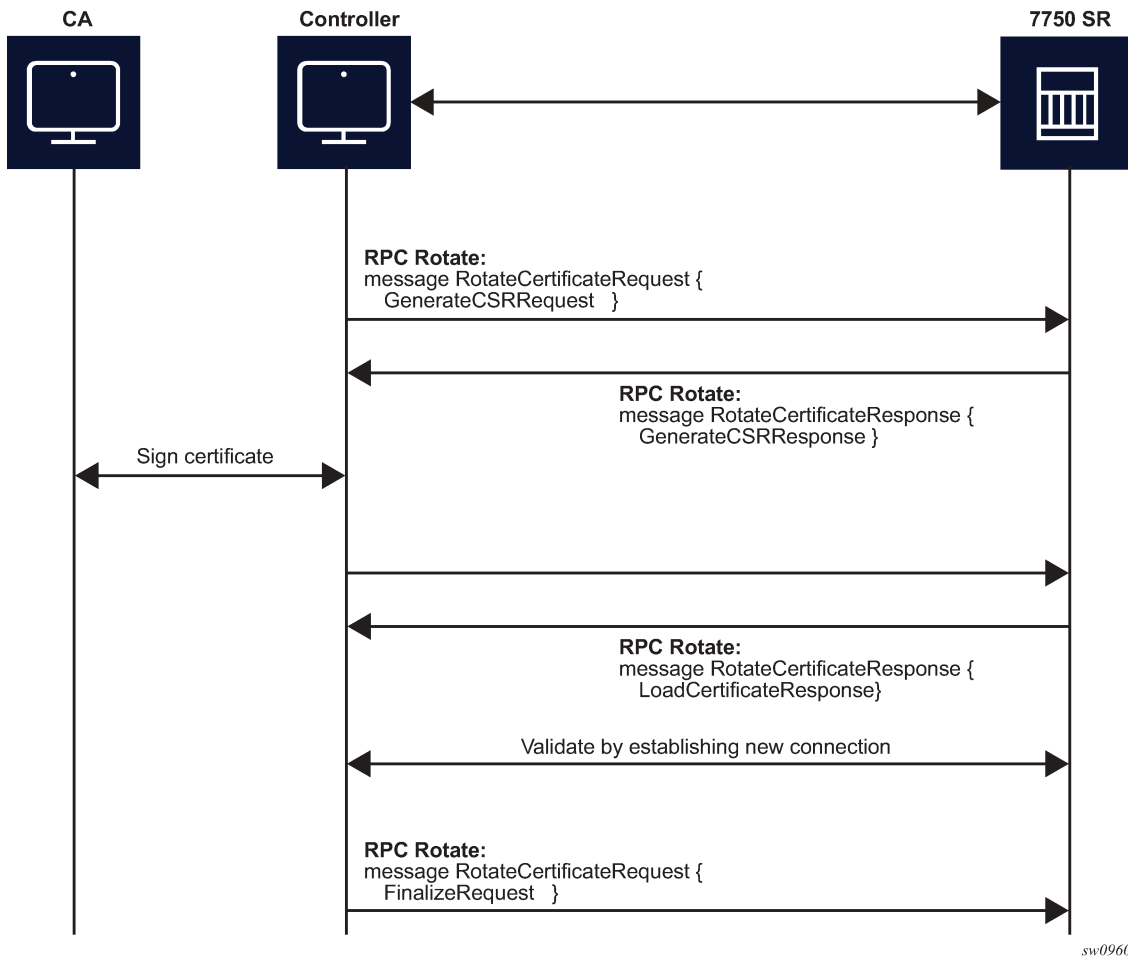
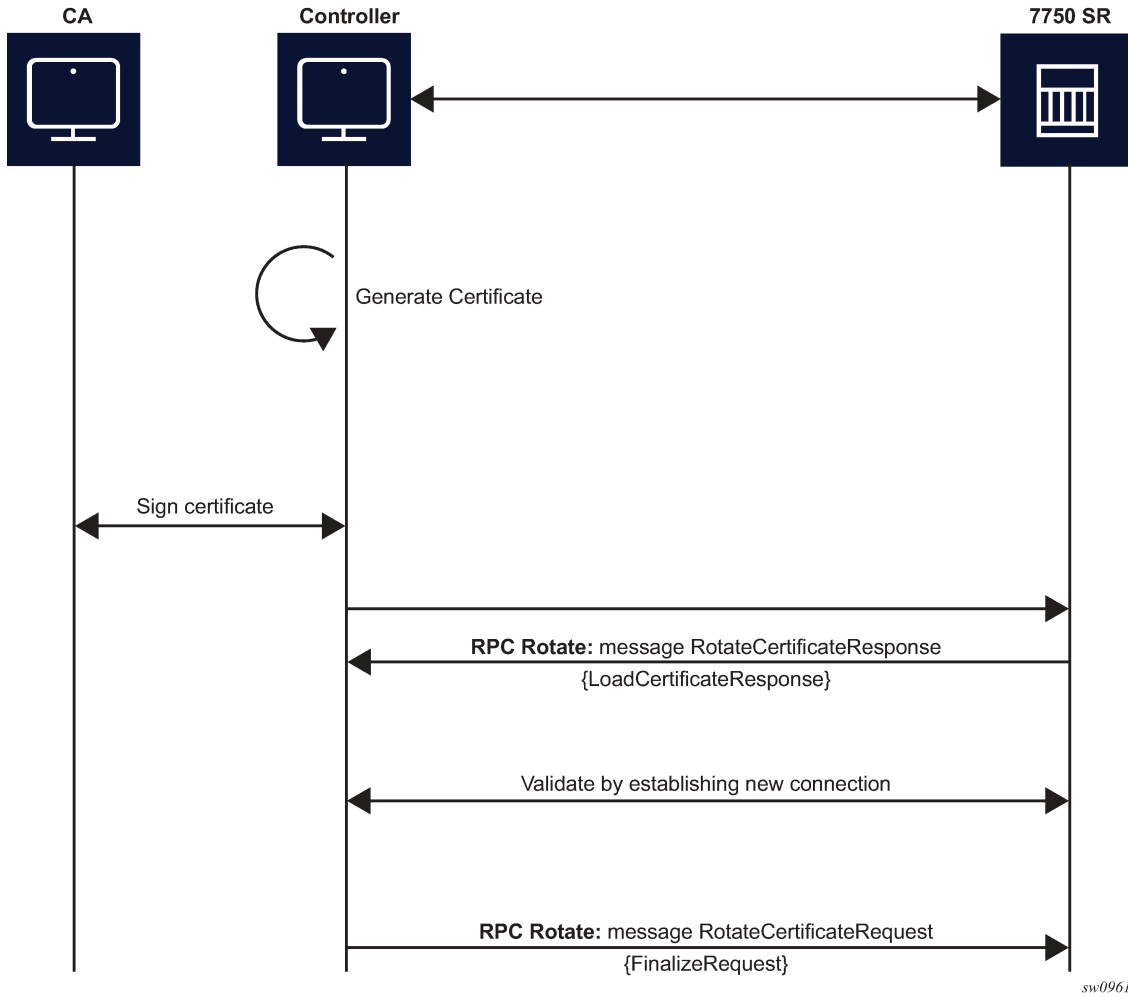

Figure 32: RPC Rotate message flow when CSRs are not generated on the SR OS node



From the perspective of the interaction of the controller and the server (SR OS) two stages are the most important:

- message exchange to generate the CSR
- message exchange to load the new certificates on the server

Figure 33: [GenerateCSR message flow](#) shows a detailed content of the messages that are exchanged for CSR generation. The SR OS accepts requests only for the X509 certificate type, RSA key type, and a minimum key length of 512 bits.

Figure 33: GenerateCSR message flow

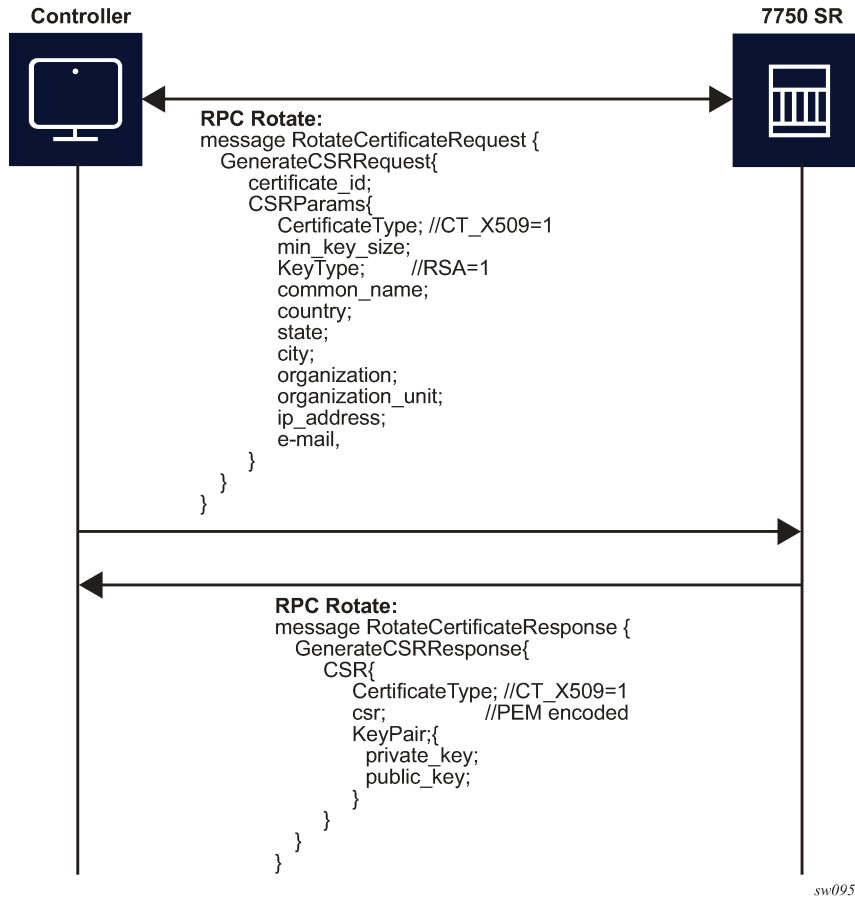

For RPC Rotate, the `certificate_id` points to an existing certificate on the node. All the other parameters in the `GenerateCSRRequest` message are not checked by the SR OS software explicitly. They are used by the internal API to generate the CSR and that result is transparently passed to the controller.

After the CA signs the certificates, the files are loaded to the server using `LoadCSRRequest` and `LoadCSRResponse` message exchange, as shown in [Figure 34: LoadCSRRequest/Response message flow](#). If this message exchange is used in the context of RPC Rotate, the `certificate_id` should not be present in `LoadCSRRequest` message. When the SR OS receives the message, it performs all the necessary steps to load this certificate, including storing the certificate and key files on the disk.

Figure 34: LoadCSRRequest/Response message flow

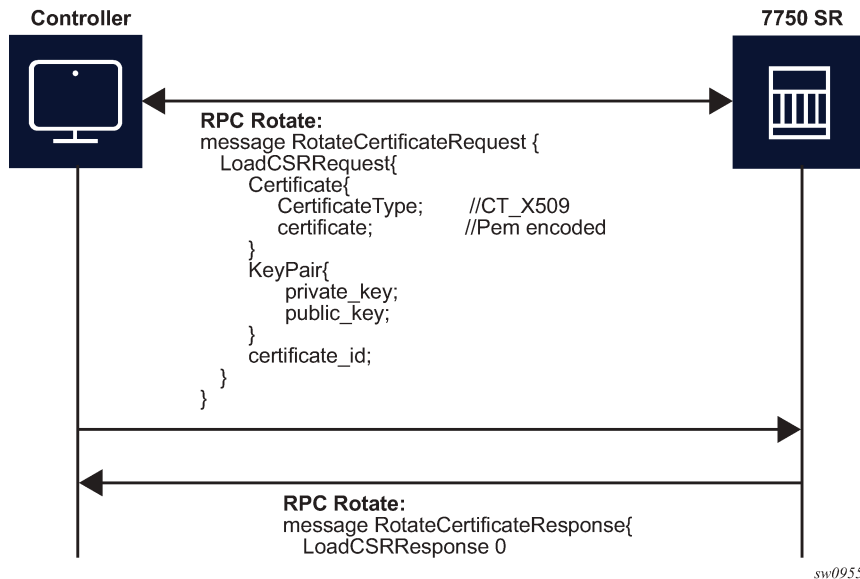

The controller is responsible for verifying the connection with the new certificate (Step 4 in [Figure 31: RPC Rotate message flow for CSRs generated on the SR OS node](#) and [Figure 32: RPC Rotate message flow when CSRs are not generated on the SR OS node](#)); SR OS treats this as an optional step.

After the whole RPC is successfully closed, the system can use the new certificate to start new TLS connections.

11.3.1.4 RPC Install

The controller can use RPC Install to install a new certificate on the server. After the certificate is installed, the server must be configured (assign a certificate and key files in the CERT profile) before the new certificate can be used.

The following two possible cases are supported for installing a certificate:

- server capable of generating a CSR (see [Figure 35: RPC install message flow for CSRs generated on the SR OS node](#))
- server is not capable of generating a CSR (see [Figure 36: RPC install message flow if CSRs are not generated on the SR OS node](#))

The SR OS supports both scenarios, although it is assumed that in most cases the CSR is generated on the SR OS node.

Both scenarios require the following steps:

1. Generate the CSR.
2. Sign the CSR by the Certificate Authority (CA).
3. Load the new certificate on the server.

Figure 35: RPC install message flow for CSRs generated on the SR OS node

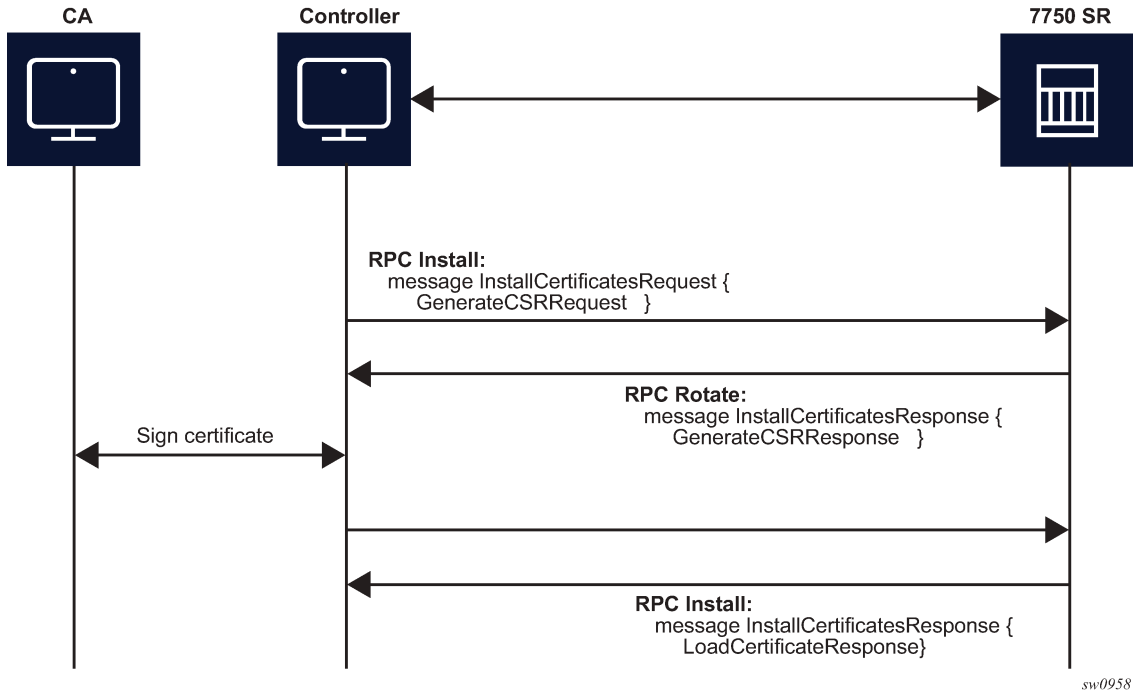
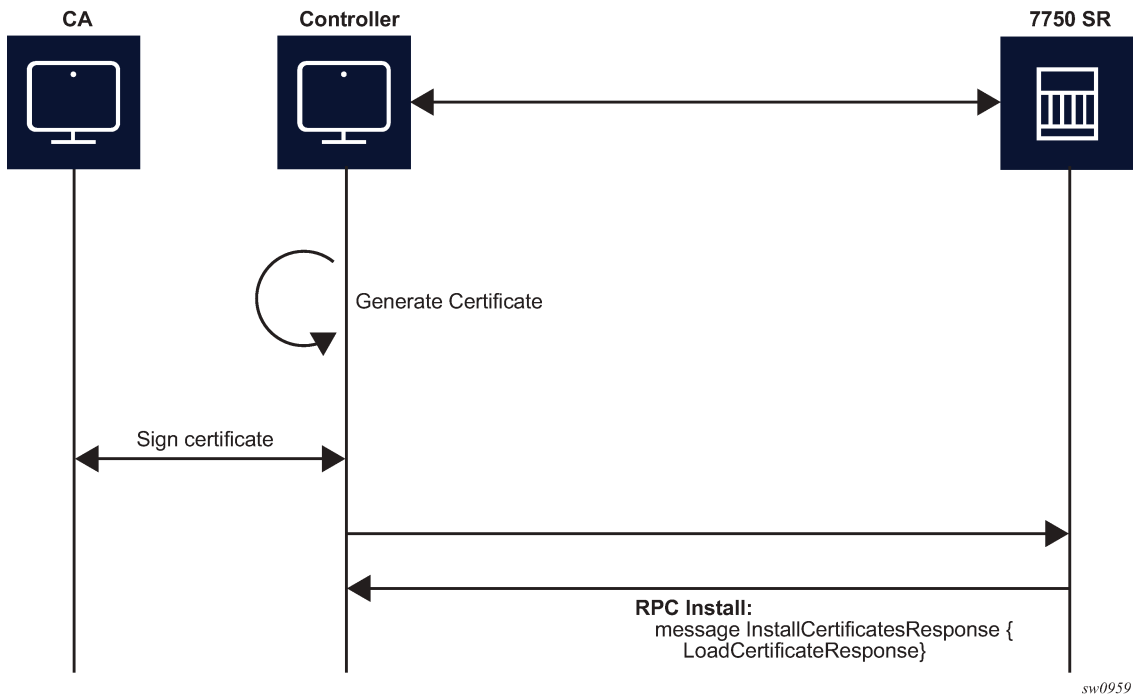

Figure 36: RPC install message flow if CSRs are not generated on the SR OS node



The message exchange during phases 1 and 3 is the same as shown in [Figure 33: GenerateCSR message flow](#) and [Figure 34: LoadCSRRequest/Response message flow](#). The only difference, in the case of RPC Install, is that, a new `certificate_id` is used.

After new certificates are installed, the system must be configured before it can be used. Configuration is supported using the following methods:

- an existing gRPC session
- a CLI session, SNMP, or NETCONF

11.3.1.5 RPC RevokeCertificates

The purpose of the RPC `RevokeCertificates` is to render the existing certificate unusable by any client. In cases where the certificate being revoked by the client does not exist on the SR OS node, the corresponding RPC silently succeeds. The message flow is shown in [Figure 37: RPC RevokeCertificates message flow](#).

Figure 37: RPC `RevokeCertificates` message flow

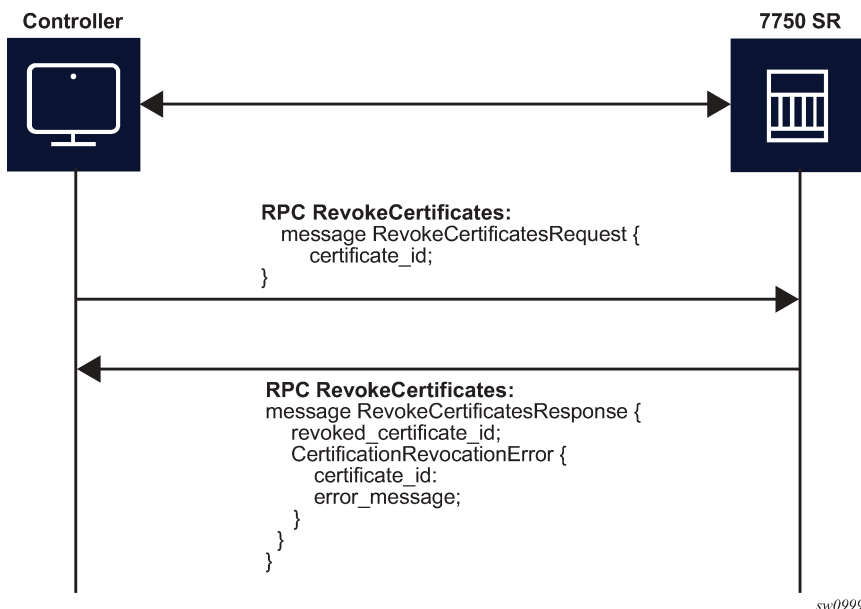

11.4 gNOI system

In the gNOI System service, OpenConfig defines a generic interface to perform operational tasks on target network nodes. The specification can be found in following link: <https://github.com/openconfig/gnoi/blob/master/system/system.proto>.

These operations can be performed on individual targets, regardless of vendor. SR OS supports the following gNOI System RPCs:

- SetPackage RPC
- Reboot RPC

- CancelReboot RPC
- RebootStatus RPC
- SwitchControlProcessor RPC
- Ping RPC
- Time RPC
- Traceroute RPC

11.4.1 SetPackage RPC

The SetPackage RPC allows the controller to place a software package on the target node. The file transfer is protected by the checksum. SR OS supports options where the controller can directly stream files to the target node. The remote download option is not supported.

The controller can use the SetPackage RPC to modify the `bof.cfg` file when the package destination is different from the bootable image path configured in `bof.cfg`.

11.4.2 Reboot, CancelReboot, and RebootStatus RPC

The Reboot RPC allows the controller to reboot a target node. The RebootRequest message can be used to specify reboot delay and system actions that should be performed during the reboot. SR OS supports only cold reboot; that is, the entire node is shut down and restarted during the reboot process. A Reboot RPC can be used to reboot both IOMs and CPMs.

The CancelReboot RPC allows the controller to cancel pending reboots.

The RebootStatus RPC allows the controller to query the status of a reboot for an individual component specified in the RebootStatus request. SR OS supports querying on a single component at the time.

11.4.3 SwitchControlProcessor RPC

The SwitchControlProcessor RPC switches the active Control-Processor to the Control-Processor that is provided in the request message. Because SR OS supports two Control Processors, one of the following paths is included in the request message, depending on which Control Processor is standby at that moment.

```
/state/cpm[cpm-slot=A]
```

```
/state/cpm[cpm-slot=B]
```

11.4.4 Ping RPC

The Ping RPC allows the controller to execute the **ping** command on the target node and results are returned to the node.

11.4.5 Time RPC

The Time RPC returns the current time on the target node. This RPC is typically used to test for a response from the target.

11.4.6 Traceroute RPC

The Traceroute RPC allows the controller to execute the **traceroute** command on the target node and results are returned to the node.

11.5 MD-CLI service

The SR OS provides a proprietary management interface to use with the Network Interface Shell (NISH) tool which allows an MD-CLI style interface from a remote location to manage one or more SR OS nodes.

This feature is applicable only on SR OS platforms that support MD-CLI in Model-Driven or mixed configuration mode.

This service operates using gRPC, and therefore, the main gRPC service must also be enabled.

When enabled, the MD-CLI gRPC service provides MD-CLI schema information to the NISH client allowing users to remotely operate the SR OS device.

The MD-CLI gRPC service and the main gRPC service must be enabled on all nodes that are managed using the NISH client.

11.5.1 Remote management using a remote network interface shell manager

When used together with the MD-CLI gRPC service, the remote management feature allows SR OS nodes to initiate communication with a remote NISH manager and announce to their availability to be managed using the NISH client. This provides the NISH client with a dynamic view of the available nodes that it can manage.

The remote management service does not perform or enable the actual management of the SR OS node using NISH. This communication is achieved directly from the NISH client to the SR OS node using the MD-CLI gRPC service.

This feature is particularly useful when deploying clusters of SR OS nodes that may dynamically join or leave a cluster, such as in scenarios that use the Control and User Plane Separation (CUPS) BNG application with Virtualized Service Routers (VSRs).

A working NISH manager service is required on an external server to use the remote management feature. However, in the absence of a working NISH manager, the system does not stop remote management from being enabled within SR OS, nor does it stop the SR OS node from announcing its presence to the configured IP address or addresses of the NISH manager.

When a remote NISH manager is configured, the SR OS node initiates a gRPC session with the configured manager. The SR OS node sends a message to communicate its name, IP address (IPv4 and IPv6 are supported), and gRPC port to the NISH manager. The NISH manager responds with an acknowledgment message. The SR OS node periodically checks in with the NISH manager.

[Figure 38: Remote management service initiation](#) shows the remote management initiation.

Figure 38: Remote management service initiation

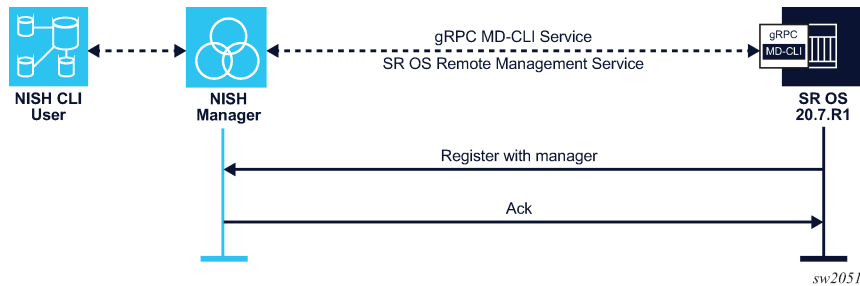

If the connection is interrupted, the SR OS node immediately attempts reconnection with the configured NISH managers.

11.6 gNOI file

In the gNOI file service, OpenConfig defines a generic interface to perform file operational tasks. For information about the gNOI specification, see the following link: <https://github.com/openconfig/gnoi/blob/master/file/file.proto>

SR OS supports the following gNOI file RPCs:

- Get RPC
- Put RPC
- Stat RPC
- Remove RPC
- TransferToRemote RPC



Note: By default, the gNOI file RPCs are enabled in the user profile.

Use the commands in the following context to configure authorization for each file RPC:

- **MD-CLI**

```
configure system security aaa local-profiles profile grpc rpc-authorization
```

- **classic CLI**

```
configure system security profile grpc rpc-authorization
```

11.6.1 Get RPC

A Get RPC reads and streams the contents of a file from a target location. The file is streamed using sequential messages and a final message containing the hash of the streamed data is sent before the stream is closed. An error is returned when:

- the file does not exist

- there is a problem reading the file

11.6.2 Put RPC

A Put RPC streams data to be written on a file on the target location. The file is streamed using sequential messages and a final message that includes the hash of the streamed data is sent before closing the stream. An error is returned when:

- the location does not exist
- an error is encountered while writing the data

11.6.3 Stat RPC

A Stat RPC returns metadata (that is, statistical information) about a file on the target location. An error is returned when:

- the file does not exist
- an error is encountered while accessing the metadata

11.6.4 Remove RPC

A Remove RPC removes the specified file from the target location. An error is returned when:

- the file does not exist
- there is a directory instead of a file
- an error is encountered during the remove operation (for example, permission denied)

11.6.5 TransferToRemote RPC

A TransferToRemote RPC transfers the file from the target node to a specified remote location. When the file transfer is complete, the response contains the hash of the transferred data. An error is returned when:

- the file does not exist
- the file transfer fails
- an error is encountered reading the file

12 gRPC tunnels

A gRPC tunnel is a client-server protocol like any other gRPC-based service. The gRPC tunnel concept is defined by OpenConfig (<https://github.com/openconfig/grpctunnel>) and is based on three entities:

- **target**
The target represents the network element.
- **tunnel server**
The tunnel server represents the software entity that tracks all registered targets, along with information about supported target types, all registered tunnel clients and the target type they subscribe to.
- **tunnel clients**
The tunnel client is a software entity that performs client tasks, such as request a session to the specified target.

The following figure shows the gRPC tunnel service concept.

Figure 39: gRPC tunnel service concept

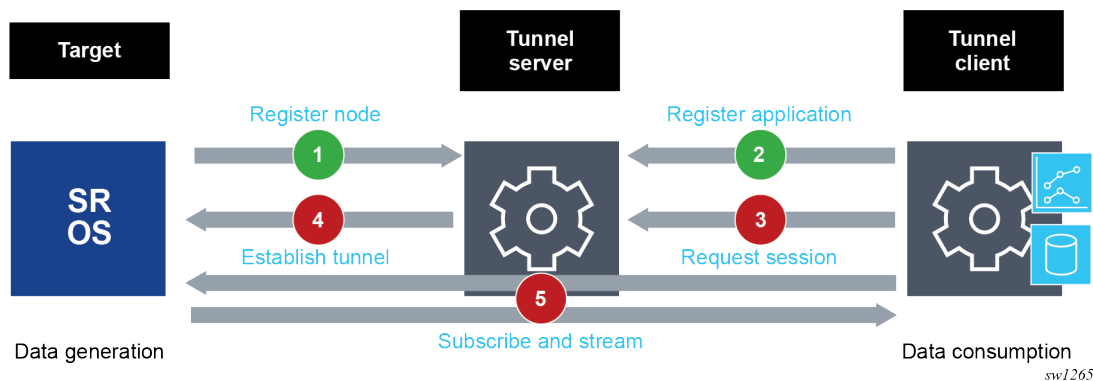

After the registration process is complete, the tunnel server informs the tunnel client about all available targets supporting the target type that it is subscribed to. The tunnel client can then request a tunnel session toward a specific target. When a request is made, the tunnel server establishes a TCP tunnel between itself and the target (if one is not already open for another session) and establishes a tunnel session between the target and the tunnel client. After this session is established, the tunnel client can open any supported application session (gNMI or gNOI) toward applications on the target.

The following RPCs are defined to facilitate gRPC tunnels.

- **RegisterRPC**
The RegisterRPC is used to perform the following tasks:
 - sent from a target to a tunnel server to register the network element after a reboot or the configuration of a gRPC tunnel on the network element
 - sent from a tunnel client to a tunnel server to subscribe to a specific target type
 - sent from a tunnel client to a tunnel server to request a session to a specified target with a specific target type
- **TunnelRPC**

The TunnelRPC is used for the actual exchange of data (in the form of TCP datagrams tagged with a tag ID agreed upon during the session registration phase of the RegisterRPC). The exchange of data on a TunnelRPC is initiated by the service used by the tunnel; for example, in a gNOI service, the controller opens a gNOI RPC that is tunneled through the gRPC tunnel. The network element handles this request like any other request received from the gNOI client directly.

Using a gRPC tunnel instead of a direct gRPC connection provides the following advantages:

- Using a gRPC tunnel avoids firewall issues by initiating the TCP connection from the network element.
- The network element registers itself, which provides active network element discovery.
- The common gRPC tunnel interface on the network element does not require any adaptations to use different management interfaces, such as gNMI, gNOI, SSH, or NETCONF.

12.1 gRPC tunnels in SR OS

This section describes how to configure and use gRPC tunnels within SR OS.

12.1.1 gRPC tunnel architecture in SR OS

The main function of a gRPC tunnel is to allow tunneling of TCP datagrams between SR OS nodes and third-party software entities. To minimize the impact on existing services, the internal cross-connect sends the decapsulated packets on a preconfigured TCP port using the local host as the destination. In this way, all internal applications receive the same data as they would from an external TCP connection.

The simplified view of the internal SR OS implementation is shown in the following figure.

Figure 40: Internal SR OS architecture

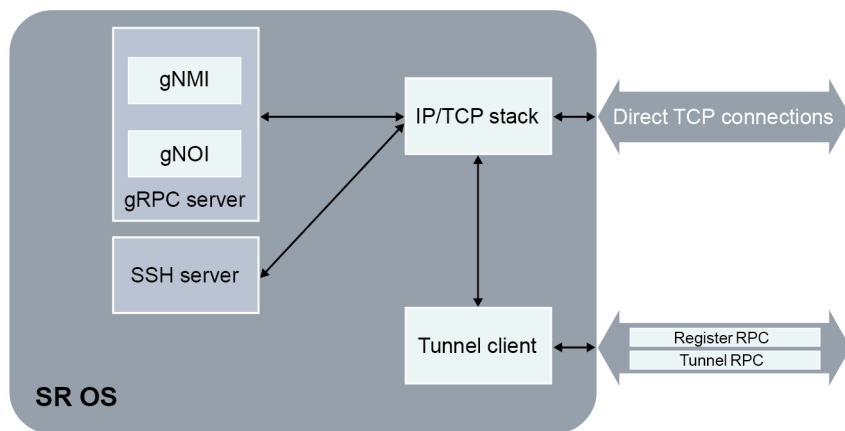

12.1.2 gRPC tunnel security

The OpenConfig gRPC tunnel specification requires TLS encryption at the tunnel and gRPC server level.

TLS encryption at tunnel level is configured by assigning the TLS client profile at the destination group level. It operates similarly to dial-out telemetry, as described in [Dial-out telemetry](#).

When an external gRPC client connects to an SR OS gRPC server through a tunnel (rather than through direct TCP connection), the source address of the tunnel is used as the IP address to generate certificates. The TLS server profile assigned to the gRPC server must point to certificates that were generated using this IP address.

12.1.3 Configuring a gRPC tunnel in SR OS

About this task

To configure use gRPC tunnel, perform the following steps:

Procedure

- Step 1.** Configure the destination group.
 - a. Configure 1 or 2 destinations using the **destination** command.
 - b. Configure whether transport is secure or unsecure using the **allow-secure-connection** command.
 - c. Configure the router instance using the **router-instance** command.
 - d. Optionally, configure a local source address using the **local-source-address** command.
 - e. Optionally, configure the TCP keepalive interval using the **tcp-keepalive** command.
- Step 2.** Configure the gRPC tunnel.
 - a. Assign a destination group using the **destination-group** command.
 - b. Enable the tunnel.
 - c. Define the target name using the **target-name** command.
 - d. Configure one or more handlers using the **handler** command.
- Step 3.** Configure the internal application server.

Example

MD-CLI

```
[ex:/configure system]
A:admin@node-2# info
  grpc-tunnel {
    destination-group "ba-server" {
      allow-unsecure-connection
      destination 1.1.1.1 port 33333 {
        router-instance "management"
      }
    }
  }
  tunnel "test" {
    admin-state enable
    destination-group "ba-server"
    target-name { node-name}
    handler "my-grpc" {
      admin-state enable
      target-type { grpc-server }
      port 57400
    }
    handler "ssh" {
```

```

        admin-state enable
        target-type { ssh-server }
        port 22
    }
}
grpc {
    admin-state enable
    allow-unsecure-connection
    gnmi {
        admin-state enable
    }
}

```

Example**Classic CLI**

```

A:node-2>config>system# info
  grpc-tunnel
    destination-group "ba-server" create
      allow-unsecure-connection
      tcp-keepalive
      shutdown
    exit
    destination 1.1.1.1 port 33333 create
      router-instance "management"
    exit
  exit
  tunnel "test" create
    destination-group "ba-server"
    target-name node-name
    handler "ssh" create
      port 22
      target-type ssh-server
      no shutdown
    exit
    handler "my-grpc" create
      port 57400
      target-type grpc-server
      no shutdown
    exit
    no shutdown
  exit
exit

  grpc
    allow-unsecure-connection
    no shutdown
    gnmi
      no shutdown
    exit
  exit

```

12.1.4 Verifying gRPC tunnel operation**About this task**

This procedure describes the commands to use to verify gRPC tunnel operation.

Procedure

Step 1. Use the following command to view the state of a GRPC tunnel.

```
show system grpc-tunnel tunnel tunnel-name
```

Example

```
=====
gRPC-Tunnel tunnel
=====
Name                : test
Administrative State : Enabled
Operational State   : Up
Description         : (Not Specified)
Destination Group   : ba-server
Operational Target Name : DUT-A
=====
```

Step 2. Use the following command to view destinations for a GRPC tunnel.

```
show system grpc-tunnel tunnel tunnel-name destinations
```

Example

```
=====
gRPC-Tunnel tunnel
=====
Name                : test
Administrative State : Enabled
Operational State   : Up
Description         : (Not Specified)
Destination Group   : ba-server
Operational Target Name : DUT-A

-----
Destinations
-----
Destination          : 1.1.1.1
Port                 : 33333
Operational State    : Up
Last Oper Down Reason : MINOR: GMI #2452: RPC refused by peer - error code
                       14 (UNAVAILABLE), error message: Connect Failed
Oper Router Instance : management
Last Oper Change     : 2022/01/13 14:59:06
Connection Attempts  : 11469

-----
No. of destinations  : 1
=====
```

13 TLS

13.1 TLS overview

Transport Layer Security (TLS) is used for two primary purposes:

- **authentication of an end device (client or server) using a digital signature (DS)**

TLS uses PKI for device authentication. DSs are used to authenticate the client or the server. The server typically sends a certificate with a DS to the client.

In specific situations, the server can request a certificate from the client to authenticate it. The client has a certificate (called a Trust Anchor) from the certificate authority (CA) which is used to authenticate server certificate and its DS. After the client provides a digitally signed certificate to the server and both parties are authenticated, the encryption PDUs can then be transmitted.

When SR OS is acting as a server and it requests a certificate from the client, the client must provide the certificate. If the client fails to provide a certificate for authentication, SR OS terminates the TLS session. The server TLS settings can be configured to not request certificates, in which case the client is not obligated to send the server a certificate for authentication.

- **encryption and authentication of application PDUs**

After the clients and server have been successfully authenticated, the cipher suite is negotiated between the server and clients, and the PDUs are encrypted based on the agreed cipher protocol.

13.2 TLS server interaction with applications

TLS is a standalone configuration. The user must configure TLS server profiles with certificates and trust anchors, and then assign the TLS server profiles to the appropriate applications. When a TLS server profile is assigned to an application, the application should not send any clear text PDUs until the TLS handshake has been successfully completed and the encryption ciphers have been negotiated between the TLS server and the TLS client.

After successful negotiation and handshake, the TLS is operationally up, and the TLS notifies the application which begins transmitting PDUs. These PDUs are encrypted using TLS based on the agreed ciphers. If, at any point, the TLS becomes operationally down, the application should stop transmitting PDUs.

For example, a TLS connection with the gRPC application would operate as follows:

1. A TLS server profile is assigned to the gRPC application.
2. gRPC stops sending clear text PDUs because a TLS server profile has been assigned and TLS is not ready to encrypt.
3. The TLS server begins the handshake.
4. Authentication occurs at the TLS layer.
5. The TLS server and TLS client negotiate ciphers.

6. SALTs are negotiated for the symmetric key. A SALT is a seed for creating AES encryption keys.
7. When negotiations are successfully completed, the handshake finishes and gRPC is notified.
8. TLS becomes operationally up, and gRPC can resume transmitting PDUs. Until TLS becomes operationally up, gRPC PDUs arriving from the client are dropped on ingress.

13.2.1 TLS application support

Table 57: TLS application support lists the applications that support TLS.

Table 57: TLS application support

| Application | TLS server supported | TLS client supported |
|-------------|----------------------|----------------------|
| gRPC | ✓ | ✓ |
| LDAP | | ✓ |
| RADIUS | | ✓ |
| Syslog | | ✓ |

13.3 TLS handshake

Figure 41: TLS handshake shows the TLS handshake.

Figure 41: TLS handshake

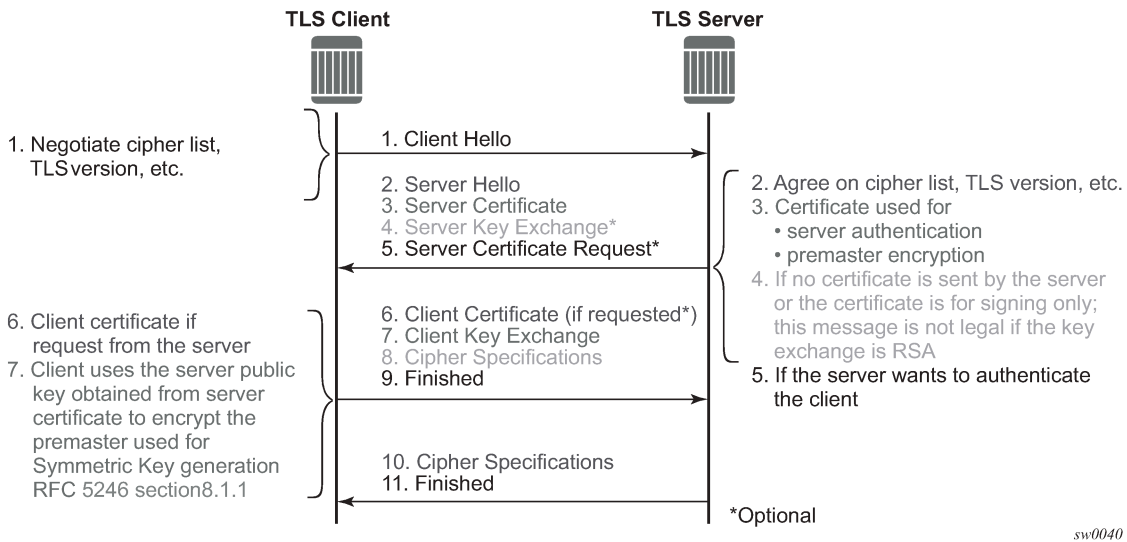

Table 58: TLS handshake step descriptions describes the steps in the TLS handshake.

Table 58: TLS handshake step descriptions

| Step | Description |
|------|---|
| 1 | The TLS handshake begins with the client Hello message. This message includes the cipher list that the client wants to use and negotiate, among other information. |
| 2 | The TLS server sends back a server Hello message, along with the first common cipher found on both the client cipher list and the server cipher list. This agreed cipher is used for data encryption. |
| 3 | The TLS server continues by sending a server certificate message, where the server provides a certificate to the client so that the client can authenticate the server identity. The public key of this certificate (RSA key) can also be used for encryption of the symmetric key seed that is used by the client and server to create the symmetric encryption key. This occurs only if the PKI is using RSA for asymmetric encryption. |
| 4 | Server key exchange is not supported by SR OS. SR OS only uses RSA keys; Diffie-Hellman key exchange is not supported. |
| 5 | The server can optionally be configured to request a certificate from the client to authenticate the client. |
| 6 | If the server has requested a certificate, the client should provide a certificate using a client certificate message. If the client does not provide a certificate, the server drops the TLS session. |
| 7 | The client uses the server public RSA key that was included in the server certificate to encrypt a seed used for creating the symmetric key. This seed is used by the client and server to create the identical symmetric key for encrypting and decrypting the data plane traffic. |
| 8 | The client sends a cipher spec to switch encryption to this symmetric key. |
| 9 | The client successfully finishes the handshake. |
| 10 | The server sends a cipher spec to switch encryption to this symmetric key. |
| 11 | The server successfully finishes the handshake. |

After a successful handshake, TLS is operationally up, and applications can then use it for application encryption.

13.4 TLS 1.3

TLS 1.3 is required for faster handshakes and stronger encryption and authentication algorithms.

All SR OS applications that use TLS 1.2 also support TLS 1.3, unless specifically stated otherwise.

The user can configure the node to use TLS 1.2, TLS 1.3, or both for its client or server negotiation.

When TLS 1.3 is negotiated with a client, the node no longer negotiates the TLS version down to 1.2 as long as the session is alive.

13.4.1 TLS 1.3 handshake

The TLS 1.3 client handshake is very similar to TLS 1.2 because the client is able to negotiate TLS 1.2 or 1.3 when starting the TLS Hello message to the server. The client includes a "Supported Version" extension in its Hello message. The server responds with its own supported version, agreed ciphers, and so on.

In TLS 1.2 and TLS 1.3, the server can optionally request for the client certificate to authenticate the client. If requested, the client must provide its certificate to the server.

13.4.2 TLS 1.3 configuration

The user can configure the TLS 1.3 cipher list independently of TLS 1.2 for both client and server ciphers. TLS 1.3 ciphers are configured using the **tls13-cipher** command.

TLS 1.3 also introduces group lists and signature lists for the server and client.

In the Hello message sent by the client, the "supported_groups" extension indicates the named groups that the client supports for the key exchange, ordered from most preferred to least preferred. TLS 1.3 supports Elliptic-Curve Diffie-Hellman Ephemeral (ECDHE) groups.



Note: TLS 1.2 does not support Diffie-Hellman groups as an asymmetric key.

TLS 1.3 also allows the selection of signature algorithms. The "signature_algorithms_cert" extension is included to allow implementations that support different sets of algorithms for certificates and in TLS itself to clearly signal their capabilities.

When the user configures a TLS 1.3 cipher list, the TLS handshake includes TLS 1.3 as a supported TLS version in the TLS handshake.

13.5 TLS client certificate

TLS protocol is used for authentication, and therefore, the server can ask to authenticate the client via PKI. If the server requests authentication from the client, the client must provide an X.509v3 certificate to the server so that it can be authenticated via the digital signature of its client. SR OS allows the configuration of an X.509v3 certificate for TLS clients. When the server requests a certificate via the server's Hello message, the client transmits its certificate to the server using a client certificate message.

13.6 Certificate revocation status verification for TLS

A certificate authority (CA) can revoke issued certificates by listing them in a certificate revocation list (CRL). In TLS, an optional CRL is applied for CA certificates. The CRL does not apply to the intermediate

or end issuer of an end entity (EE) certificate. To extend this optional configuration to include EE certificates, use the **status-verify default-result** commands under the following contexts:

- **configure system security tls client-tls-profile**
- **configure system security tls server-tls-profile**

The command options are **revoked** (default value) or **good**.

This default result is used when the revocation status of a certificate cannot be determined because of an invalid CRL (for example, it is missing, expired, or corrupt).

The TLS **default-result** for EE certificates is set to **revoked** for safety purposes. If an expired CRL in the CA profile is matched as the issuer of the EE certificate, the EE certificate is treated as revoked. If the expired CRL is further up in the certificate chain, the optional CRL works as expected.

The **status-verify default-result** commands allow users to override the recommended revocation check policy when there is legitimate reason to accept EE certificates without checking their revocation status (for example, to keep the automatic CRL update working during a temporary network issue).

13.7 TLS symmetric key rollover

SR OS supports key rollover via HelloRequest messages as detailed in RFC 5246, section 7.4.1.1. Some applications have a longer live time than other applications, in which case SR OS can use a timer that prompts the HelloRequest negotiation for the symmetric key rollover. This timer is configurable using CLI.

Use the following command to configure the TLS re-negotiate timer.

```
configure system security tls server-tls-profile tls-re-negotiate-timer
```

If an application does not support the HelloRequest message, you can disable the timer configuration. For example, the gRPC application does not support HelloRequest messages. When the time is not configured, the HelloRequest message is not generated, and symmetric keys are not renegotiated.

13.8 Supported TLS ciphers

As shown in [Figure 41: TLS handshake](#), TLS negotiates the supported ciphers between the client and the server.

The client sends the supported cipher suites in the client Hello message, and the server compares them with the server cipher list. The top protocol on both lists is chosen and returned from the server within the server Hello message.

The 7750 SR supports the following ciphers as a TLS 1.2 client or TLS server:

- `tls-rsa-with3des-edc-cbc-sha`
- `tls-rsa-with-aes128-cbc-sha`
- `tls-rsa-with-aes256-cbc-sha`
- `tls-rsa-with-aes128-cbc-sha256`
- `tls-rsa-with-aes256-cbc-sha256`
- `tls-rsa-with-aes128-gcm-sha256`

- `tls-rsa-with-aes256-gcm-sha384`

The 7750 SR supports the following TLS 1.3 ciphers, groups, and signature algorithms as a TLS client or TLS server:

- `tls-aes128-gcm-sha256`
- `tls-aes256-gcm-sha384`
- `tls-chacha20-poly1305-sha256`
- `tls-aes128-ccm-sha256`
- `tls-aes128-ccm8-sha256`
- **Groups:**
 - `tls-ecdh-256`
 - `tls-ecdh-384`
 - `tls-ecdh-521`
 - `tls-x25519`
 - `tls-x448`
- **Signature algorithms:**
 - `tls-rsa-pkcs1-sha256`
 - `tls-rsa-pkcs1-sha384`
 - `tls-rsa-pkcs1-sha512`
 - `tls-ecdsa-secp256r1-sha256`
 - `tls-ecdsa-secp384r1-sha384`
 - `tls-ecdsa-secp521r1-sha512`
 - `tls-rsa-pss-rsae-sha256`
 - `tls-rsa-pss-rsae-sha384`
 - `tls-rsa-pss-rsae-sha512`
 - `tls-rsa-pss-pss-sha256`
 - `tls-rsa-pss-pss-sha384`
 - `tls-rsa-pss-pss-sha512`
 - `tls-ed25519`
 - `tls-ed448`

13.9 SR OS certificate management

SR OS implements a centralized certificate management protocol that can be used by TLS and IPsec.

Use the commands in the following contexts to configure and manage certificates:

- **MD-CLI**

```
admin system security pki
```

```
configure system security pki
```

- **classic CLI**

```
admin certificate  
configure system security pki
```

13.9.1 Certificate profile

The certificate profile is available for both the TLS server and the TLS client. The **cert-profile** command is configured for the server or client to transmit the provider certificate and its DS to the peer so that the peer can authenticate it via the **trust-anchor** and CA certificate.

Multiple provider certificates can be configured on SR OS; however, SR OS currently uses the smallest index as the active provider certificate, and only sends the certificate to the peer.

13.9.2 TLS server authentication of the client certificate CN field

If the client provides a certificate upon request by the server, SR OS checks the certificate's common name (CN) field against local CN configurations. The CN is validated via the client IPv4/IPv6 address or FQDN.

If the common-name list authentication option is not enabled, SR OS does not authenticate via the CN field and only relies on certificate signature authentication.

13.9.3 CN regexp format

Use commands in the following context to configure CN entries.

```
configure system security pki common-name-list
```

Entries should use regular expression (regexp), for example FQDN or the IP address.

For information about regexp, see the *7450 ESS, 7750 SR, 7950 XRS, and VSR Classic CLI Command Reference Guide*, Entering CLI commands section.

13.10 Operational guidelines

13.10.1 Server authentication behavior

Following the Hello messages, the server sends its certificate in a certificate message if it is to be authenticated. If required, a ServerKeyExchange message may also be sent. See RFC 5246, section 7.3, for more information about the authentication behavior on the LDAP server.

Use the commands in the following context to configure client TLS security. The **trust-anchor-profile** command determines whether the server must be authenticated by the client.

```
configure system security tls client-tls-profile trust-anchor-profile
```



Note: If the **trust-anchor-profile** is configured and the **ca-certificate** or **ca-profile** is missing from this **trust-anchor-profile**, the TLS connection fails and an "unknown_ca" error is generated, as per RFC 5246 section 7.2.2.

One of the following two configurations can be used to establish server connectivity:

1. If **trust-anchor-profile** is configured under the TLS **client-tls-profile** context, the server must be authenticated via the **trust-anchor-profile** command before a trusted connection is established between the server and the client.
2. If there is no **trust-anchor-profile** under the **client-tls-profile** context, the trusted connection can be established without server authentication. The RSA key of the certificate is used for public key encryption, requiring basic certificate checks to validate the certificate. These basic checks are as follows:
 - **time validity**
The certificate is checked to ensure that it is neither expired nor not yet valid.
 - **certificate type**
The certificate is not a CA certificate.
 - **keyUsage extension**
If present, this must contain a digital signature and key encryption.
 - **host verification**
The IP address or DNS name of the server is looked up, if available (for LDAP, only the IP address is used), in the common name (cn) or subjectAltName extension. This is to verify that the certificate was issued to that server and not to another.

13.10.2 Client TLS profile and trust anchor behavior and scale

SR OS allows the creation of client TLS profiles, which can be assigned to applications such as LDAP to encrypt the application layer.

The **client-tls-profiles** command is used for negotiating and authenticating the server. After the server is authenticated via the trust anchor profile (configured using the **trust-anchor-profile** command) of a client TLS profile, it negotiates the ciphers and authentication algorithms to be used for encryption of the data.

The client TLS profile must be assigned to an application for it to start encrypting. Up to 16 client TLS profiles can be configured. Because each of these client TLS profiles needs a trust anchor profile to authenticate the server, up to 16 trust anchor profiles can be configured. A trust anchor profile holds up to 8 trust anchors (configured using the **trust-anchor** command), which each hold a CA profile (**ca-profile**).

A CA profile is a container for installing CA certificates (**ca-certificates**). These CA certificates are used to authenticate the server certificate. When the client receives the server certificate, it reads through the trust anchor profile CA certificates and tries to authenticate the server certificate against each CA certificate. The first CA certificate that authenticates the server is used.

13.11 LDAP redundancy and TLS

LDAP supports up to five redundant (backup) servers, as shown in [Figure 42: LDAP and TLS redundancy](#) and the configuration examples below. Depending on the **timeout** and **retry** configurations, if an LDAP

server is determined to be out of service or operationally down, SR OS switches to the redundant servers. SR OS selects the LDAP server with the next largest configured server index.

Figure 42: LDAP and TLS redundancy

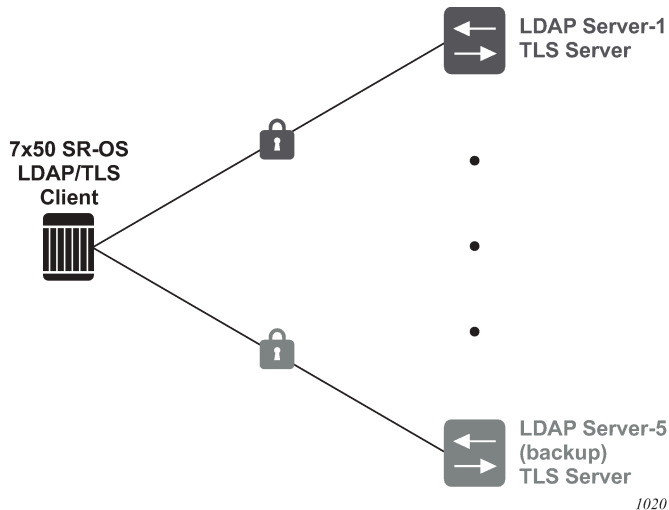

Each LDAP server can have its own TLS profile, each of which can have its own configuration of **trust-anchor** and **cipher-list**. For security reasons, the LDAP servers may be in different geographical areas and, therefore, each are assigned their own server certificate and trust anchor. The design is open to allow the user to mix and match all components.

Example: MD-CLI

```
[ex:/configure system security aaa remote-servers ldap]
A:admin@node-2# info
  public-key-authentication true
  server 1 {
    address 1.1.1.1
    server-name "active-server"
    tls-profile "server-1-profile"{
  }
}

[ex:/configure system security tls]
A:admin@node-2# info
  client-tls-profile "server-1-profile" {
    admin-state enable
    cipher-list "to-active-server"
    trust-anchor-profile "server-1-ca"
  }

[ex:/configure system security aaa remote-servers ldap]
A:admin@node-2# info
  public-key-authentication true
  server 5 {
    address 5.5.5.1
    server-name "backup-server"
    tls-profile "server-5-profile"{
  }
}

[ex:/configure system security tls]
```

```
A:admin@node-2# info
  client-tls-profile "server-5-profile" {
    admin-state enable
    cipher-list "to-backup-server-5"
    trust-anchor-profile "server-5-ca"
  }
```

Example: classic CLI

```
A:node-2>config>system>security>ldap# info
public-key-authentication
server 1 create
  address 1.1.1.1
  ldap-server "active-server"
  tls-profile "server-1-profile"

A:node-2>config>system>security>tls# info
client-tls-profile "server-1-profile" create
cipher-list "to-active-server"
trust-anchor-profile "server-1-ca"
no shutdown
exit

A:node-2>config>system>security>ldap# info
public-key-authentication
server 5 create
  address 5.5.5.1
  ldap-server "backup-server-5"
  tls-profile "server-5-profile"

A:node-2>config>system>security>tls# info
client-tls-profile "server-5-profile" create
cipher-list "to-backup-server-5"
trust-anchor-profile "server-5-ca"
no shutdown
exit
```

13.12 Basic TLS configuration

Basic TLS server configuration requires the following:

- Use the following command to create a cipher list.

```
configure system security tls server-cipher-list
```

- Use the following command to assign the cipher list to the TLS server profile.

```
configure system security tls server-tls-profile cipher-list
```

- Use the following command to create a certificate profile.

```
configure system security tls cert-profile
```

- Use the following command to assign the certificate profile to the TLS server profile.

```
configure system security tls server-tls-profile cert-profile
```

Basic TLS client configuration requires the following:

- Use the following command to create a cipher list.

```
configure system security tls client-cipher-list
```

- Use the following command to assign a TLS client to the TLS client profile.

```
configure system security tls client-tls-profile cipher-list
```

TLS imports the trust anchor certificate for (TLS) peer certificate authentication and public key retrieval.

The following example shows a TLS configuration.

Example: MD-CLI

```
[ex:/configure system security tls]
A:admin@node-2# info
  client-cipher-list "to-active-server" {
    tls12-cipher 1 {
      name tls-rsa-with-aes256-cbc-sha256
    }
    tls12-cipher 2 {
      name tls-rsa-with-aes128-cbc-sha256
    }
    tls12-cipher 3 {
      name tls-rsa-with-aes256-cbc-sha
    }
  }
  client-tls-profile "server-1-profile" {
    admin-state enable
    cipher-list "to-active-server"
    trust-anchor-profile "server-1-ca"
  }
  trust-anchor-profile "server-1-ca" {
    trust-anchor "tls-server-1-ca" { }
  }
}
```

Example: classic CLI

```
A:node-2>config>system>security>tls# info
-----
  trust-anchor-profile "server-1-ca" create
    trust-anchor "tls-server-1-ca"
  exit
  client-cipher-list "to-active-server" create
    cipher 1 name tls-rsa-with-aes256-cbc-sha256
    cipher 2 name tls-rsa-with-aes128-cbc-sha256
    cipher 3 name tls-rsa-with-aes256-cbc-sha
  exit
  client-tls-profile "server-1-profile" create
    cipher-list "to-active-server"
    trust-anchor-profile "server-1-ca"
    no shutdown
  exit
-----
```

13.13 Common configuration tasks

13.13.1 Configuring a server TLS profile

Use the commands in the following context to configure a TLS server profile.

```
configure system security tls server-tls-profile
```

13.13.2 Configuring a client TLS profile

Use the commands in the following context to configure a TLS client profile.

```
configure system security tls client-tls-profile
```

13.13.3 Configuring a TLS client or TLS server certificate

Use the following commands to configure TLS certificate management.

```
configure system security tls cert-profile
configure system security tls client-tls-profile cert-profile
configure system security tls server-tls-profile cert-profile
```

13.13.4 Configuring a TLS trust anchor

Use the commands in the following contexts to configure a TLS trust anchor.

```
configure system security pki ca-profile
configure system security pki certificate-display-format
configure system security tls trust-anchor-profile
configure system security tls client-tls-profile
```

The following example shows a TLS trust anchor configuration.

Example: MD-CLI

```
[ex:/configure system security pki]
A:admin@node-2# info
  ca-profile "tls-server-1-ca" {
    admin-state enable
    cert-file "tls-1-Root-CERT"
    crl-file "tls-1-CRL-CERT"
  }

[ex:/configure system security tls]
A:admin@node-2# info
  client-tls-profile "server-1-profile" {
    admin-state enable
    cipher-list "to-active-server"
    trust-anchor-profile "server-1-ca"
  }
```

```
trust-anchor-profile "server-1-ca" {  
    trust-anchor "tls-server-1-ca" { }  
}
```

Example: classic CLI

```
A:node-2>config>system>security>pki# info  
-----  
    ca-profile "tls-server-1-ca" create  
    cert-file "tls-1-Root-CERT"  
    crl-file "tls-1-CRL-CERT"  
    no shutdown  
    exit  
-----  
A:node-2>config>system>security>tls# info  
-----  
    trust-anchor-profile "server-1-ca" create  
    trust-anchor "tls-server-1-ca"  
    exit  
    client-tls-profile "server-1-profile" create  
    cipher-list "to-active-server"  
    trust-anchor-profile "server-1-ca"  
    no shutdown  
    exit
```

14 Facility alarms

14.1 Facility alarms overview

Facility alarms provide a useful tool for operators to easily track and display the basic status of their equipment facilities. Facility Alarm support is intended to cover a focused subset of router states that are likely to indicate service impacts (or imminent service impacts) related to the overall state of hardware assemblies (cards, fans, links, and so on).

In the CLI, for brevity, the keyword or command **alarm** is used for commands related to facility alarms. This chapter may occasionally use the term **alarm** as a short form for **facility alarm**.

The CLI display for show routines allows the system operator to easily identify current facility alarm conditions and recently cleared facility alarms without searching event logs or monitoring various card and port show commands to determine the health of basic equipment in the system such as cards and ports.

The SR OS alarm model is based on RFC 3877, *Alarm Management Information Base (MIB)*, (which evolved from the IETF Disman drafts).

14.2 Facility alarms versus log events

Facility Alarms are different from log events. Facility alarms have a state (at least two states: active and clear) and a duration, and can be modeled with state transition events (raised, cleared). A log event occurs when the state of some object in the system changes. Log events notify the operator of a state change (for example, a port going down, an IGP peering session coming up, and so on). Facility alarms show the list of hardware objects that are currently in a bad state. Facility alarms can be examined at any time by an operator, whereas log events can be sent by a router asynchronously when they occur (for example, as an SNMP notification or trap, or a syslog event).

While log events provide notifications about a large number of different types of state changes in SR OS, facility alarms are intended to cover a focused subset of router states that are likely to indicate service impacts (or imminent service impacts) related to the overall state of hardware assemblies (cards, fans, links, and so on).

The facility alarm module processes log events to generate the raised and cleared state for the facility alarms. If a raising log event is suppressed under event-control, then the associated facility alarm is not raised. If a clearing log event is suppressed under event-control, then it is still processed for the purpose of clearing the associated facility alarm. If a log event is a raising event for a Facility Alarm, and the associated Facility Alarm is raised, then changing the log event to **suppress** clears the associated Facility Alarm.

Log event filtering, throttling and discarding of log events during overload do not affect facility alarm processing. In all cases, non-suppressed log events are processed by the facility alarm module before they are discarded.

[Figure 43: Log events, facility alarms and LEDs](#) illustrates the relationship of log events, facility alarms and the LEDs.

Figure 43: Log events, facility alarms and LEDs

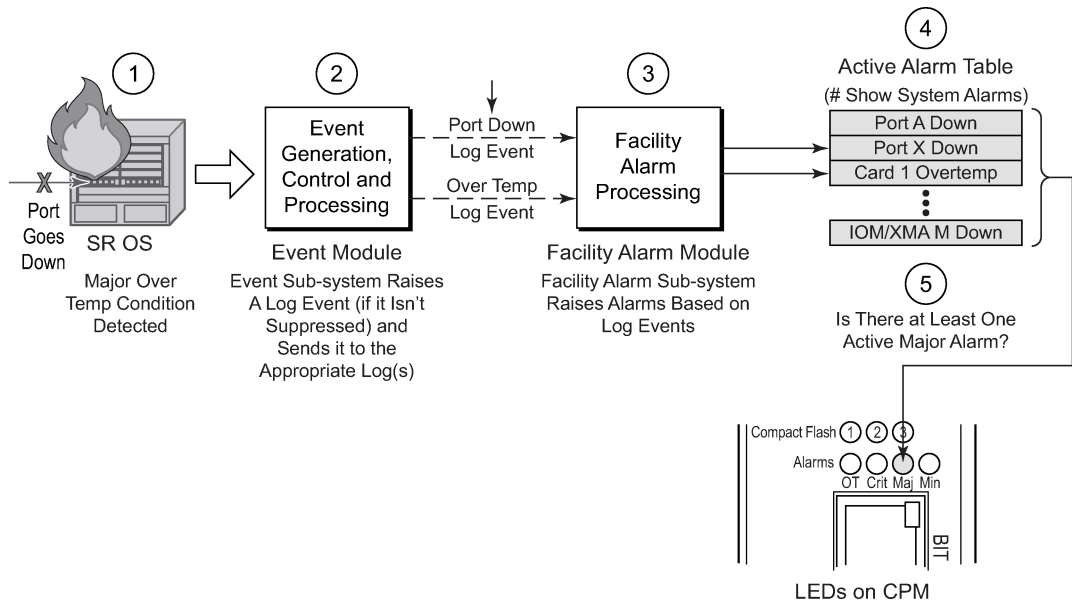

OSSG651

Facility alarms are different and have independent functionality from other uses of the term alarm in SR OS such as:

- log events that use the term **alarm** (tmnxEqPortSonetAlarm)
- alarms configuration in the following contexts.

```
configure card fp hi-bw-mcast-src alarm
configure multicast-management multicast-info-policy bundle channel source-override video analyzer alarms
configure port ethernet report-alarm
configure system thresholds rmon alarm
configure system security cpu-protection policy alarm
```

- memory-use alarms:

- **MD-CLI**

```
configure system thresholds kb-memory-use-alarm
```

- **classic CLI**

```
configure system thresholds memory-use-alarm
```

14.3 Facility alarm severities and alarm LED behavior

The alarm LEDs on the CPM/CCM reflects the current status of the facility alarms:

- The critical alarm LED is lit if there is 1 or more active critical facility alarms
- Similarly with the Major and Minor alarm LEDs

- The OT alarm LED is not controlled by the facility alarm module

The supported alarm severities are as follows:

- Critical (with an associated LED on the CPM/CCM)
- Major (with an associated LED on the CPM/CCM)
- Minor (with an associated LED on the CPM/CCM)
- Warning (no LED)

Facility alarms inherit their severity from the raising log event.

A raising log event for a facility alarm configured with a severity of *indeterminate* or *cleared* results in the facility alarm not being raised. But, a clearing log event is processed to clear facility alarms, regardless of the severity of the clearing log event.

Changing the severity of a raising log event only affects subsequent occurrences of that log event and facility alarms. Facility alarms that are already raised when their raising log event severity is changed maintain their original severity.

14.4 Facility alarm hierarchy

Facility alarms for children objects is not raised for failure of a parent object. For example, when an MDA or XMA fails (or is shutdown) there is not a set of port facility alarms raised.

When a parent facility alarm is cleared, children facility alarms that are still in occurrence on the node appears in the active facility alarms list. For example, when a port fails there is a port facility alarm, but if the MDA or XMA is later shutdown the port alarm is cleared (and a card alarm is active for the MDA or XMA). If the MDA or XMA comes back into service, and the port is still down, then a port alarm becomes active again.

The supported facility alarm hierarchy is as follows (parent objects that are down cause alarms in all children to be masked):

- CPM -> Compact Flash
- CCM -> Compact Flash
- IOM/IMM -> MDA -> Port -> Channel
- XCM -> XMA -> Port



Note: A masked facility alarm is not the same as a cleared facility alarm. The cleared facility alarm queue does not display entries for previously raised facility alarms that are currently masked. If the masking event goes away, then the previously raised facility alarms are visible again in the active facility alarm queue.

14.5 Facility alarm list

[Table 59: Facility alarm, facility alarm name, raising log event, sample details string and clearing log event](#) and [Table 60: Facility alarm name/raising log event, cause, effect and recovery](#) show the supported facility alarms.

Table 59: Facility alarm, facility alarm name, raising log event, sample details string and clearing log event

| Facility alarm | Facility alarm name/raising log event | Sample details string | Clearing log event |
|----------------|---|---|---------------------------------|
| 295-2430-1 | tmnxPowerSupplyFanFailed | Chassis 1 Power Shelf 1 Power Module 3 fan failed | tmnxPowerSupplyFanFailed Clear |
| 59-2004-1 | linkDown | Interface intf-towards-node-B22 is not operational | linkUp |
| 64-2091-1 | tmnxSysLicenseInvalid | Error - <reason> record. <hw> will reboot the chassis <timeRemaining> | tmnxSysLicenseValid |
| 64-2092-1 | tmnxSysLicenseExpiresSoon | The license installed on <hw> expires <time Remaining> | tmnxSysLicenseValid |
| 64-2221-1 | tmnxSysStandbyLicensingError | CPM B is not licensed; license record not found | tmnxSysStandbyLicensing Ready |
| 93-2006-1 | tmnxSatSynclfTimHoldover | Synchronous timing interface on satellite esat-1 is in holdover state | tmnxSatSynclfTimHoldover Clear |
| 93-2008-1 | tmnxSatSynclfTimRef1Alarm with attribute tmnxSynclfTimingNotify Alarm == 'los(1)' | Synchronous timing interface on satellite, alarm on reference 1 | tmnxSatSynclfTimRef1Alarm Clear |
| 93-2008-2 | tmnxSatSynclfTimRef1Alarm with attribute tmnxSynclfTimingNotify Alarm == 'oof(2)' | Synchronous timing interface on satellite, alarm on reference 1 | same as 93-2008-1 |
| 93-2008-3 | tmnxSatSynclfTimRef1Alarm with attribute tmnxSynclfTimingNotify Alarm == 'oopir(3)' | Synchronous timing interface on satellite, alarm on reference 1 | same as 93-2008-1 |
| 93-2010-x | same as 93-2008-x but for ref2 | same as 93-2008-x but for ref2 | same as 93-2008-x but for ref2 |
| 7-2001-1 | tmnxEqCardFailure | Class MDA Module: failed, reason: Mda 1 failed startup tests | tmnxChassisNotificationClear |
| 7-2003-1 | tmnxEqCardRemoved | Class CPM Module: removed | tmnxEqCardInserted |
| 7-2004-1 | tmnxEqWrongCard | Class IOM Module: wrong type inserted | tmnxChassisNotificationClear |
| 7-2005-1 | tmnxEnvTempTooHigh | Chassis 1: temperature too high | tmnxChassisNotificationClear |

| Facility alarm | Facility alarm name/raising log event | Sample details string | Clearing log event |
|----------------|---|--|--|
| 7-2011-1 | tmnxEqPowerSupplyRemoved | Power supply 1, power lost | tmnxEqPowerSupplyInserted |
| 7-2017-1 | tmnxEqSynclfTimingHoldover | Synchronous Timing interface in holdover state | tmnxEqSynclfTimingHoldover Clear |
| 7-2019-1 | tmnxEqSynclfTimingRef1Alarm with attribute tmnxSynclfTiming NotifyAlarm == 'los(1)' | Synchronous Timing interface, alarm los on reference 1 | tmnxEqSynclfTimingRef1Alarm Clear |
| 7-2019-2 | tmnxEqSynclfTimingRef1Alarm with attribute tmnxSynclfTiming NotifyAlarm == 'oof(2)' | Synchronous Timing interface, alarm oof on reference 1 | same as 7-2019-1 |
| 7-2019-3 | tmnxEqSynclfTimingRef1Alarm with attribute tmnxSynclfTiming NotifyAlarm == 'oopir(3)' | Synchronous Timing interface, alarm oopir on reference 1 | same as 7-2019-1 |
| 7-2021-x | same as 7-2019-x but for ref2 | same as 7-2019-x but for ref2 | same as 7-2019-x but for ref2 |
| 7-2030-x | same as 7-2019-x but for the BITS input | same as 7-2019-x but for the BITS input | same as 7-2019-x but for the BITS input |
| 7-2033-1 | tmnxChassisUpgradeInProgress | Class CPM Module: software upgrade in progress | tmnxChassisUpgradeComplete |
| 7-2073-x | same as 7-2019-x but for the BITS2 input | same as 7-2019-x but for the BITS2 input | same as 7-2019-x but for the BITS2 input |
| 7-2092-1 | tmnxEqPowerCapacityExceeded | The system has reached maximum power capacity <x> watts | tmnxEqPowerCapacity ExceededClear |
| 7-2094-1 | tmnxEqPowerLostCapacity | The system can no longer support configured devices. Power capacity dropped to <x> watts | tmnxEqPowerLostCapacity Clear |
| 7-2096-1 | tmnxEqPowerOverloadState | The system has reached critical power capacity. Increase available power now | tmnxEqPowerOverloadState Clear |
| 7-2104-1 | tmnxEqLowSwitchFabricCap | The switch fabric capacity is less than the forwarding capacity of IOM 1 because of errors in fabric links | tmnxEqLowSwitchFabricCap Clear |
| 7-2134-1 | tmnxSynclfTimBITS2048khz Unsup | The revision of 1/1 does not meet the specifications to | tmnxSynclfTimBITS2048khz UnsupClr |

| Facility alarm | Facility alarm name/raising log event | Sample details string | Clearing log event |
|----------------|---------------------------------------|--|------------------------------------|
| | | support the 2048kHz BITS interface type | |
| 7-2136-1 | tmnxEqMgmtEthRedStandby Raise | The standby CPM's management Ethernet port A/1 is serving as the system's management Ethernet port | tmnxEqMgmtEthRedStandby Clear |
| 7-2138-1 | tmnxEqPhysChassPowerSupOvr Tmp | Power supply 2 over temperature | tmnxEqPhysChassPowerSup OvrTmpClr |
| 7-2140-1 | tmnxEqPhysChassPowerSup AcFail | Power supply 1 AC failure | tmnxEqPhysChassPowerSup AcFailClr |
| 7-2142-1 | tmnxEqPhysChassPowerSup DcFail | Power supply 2 DC failure | tmnxEqPhysChassPowerSup DcFailClr |
| 7-2144-1 | tmnxEqPhysChassPowerSup InFail | Power supply 1 input failure | tmnxEqPhysChassPowerSup InFailClr |
| 7-2146-1 | tmnxEqPhysChassPowerSupOut Fail | Power supply 1 output failure | tmnxEqPhysChassPowerSup OutFailClr |
| 7-2148-1 | tmnxEqPhysChassisFanFailure | Fan 2 failed | tmnxEqPhysChassisFanFailure Clear |
| 7-2153-1 | tmnxCpmMemSizeMismatch | The standby CPM A has a different memory size than the active B | tmnxCpmMemSizeMismatch Clear |
| 7-2156-1 | tmnxPhysChassPwrSupWrgFan Dir | The front to back fan direction for chassis 1 power supply 1 is not supported | tmnxPhysChassPwrSupWrgFan DirClr |
| 7-2157-1 | tmnxPhysChassPwrSup PemACRect | Chassis 1 power supply 1 ac Rec1 failed or missing | tmnxPhysChassPwrSup PemACRectClr |
| 7-2159-1 | tmnxPhysChassPwrSupInput Feed | Chassis 1 power supply 1 inputFeedA not supplying power | tmnxPhysChassPwrSupInput FeedClr |
| 7-2161-1 | tmnxEqBpEpromFail | The active CPM is no longer able to access any of backplane EPROMs because of a hardware defect | tmnxEqBpEpromFailClear |
| 7-2163-1 | tmnxEqBpEpromWarning | The active CPM is no longer to access one backplane EPROM because of a | tmnxEqBpEpromWarningClear |

| Facility alarm | Facility alarm name/raising log event | Sample details string | Clearing log event |
|----------------|---------------------------------------|---|---------------------------------|
| | | hardware defect but a redundant EPROM is present and accessible. | |
| 7-2165-1 | tmnxPhysChassisPCMIInputFeed | Chassis 1 pcm 1 1 not supplying power | tmnxPhysChassisPCMIInputFeedClr |
| 7-2190-1 | tmnxPhysChassisPMOutFail | Chassis 1 Power Shelf 1 Power Module 4 output failure | tmnxPhysChassisPMOutFailClr |
| 7-2192-1 | tmnxPhysChassisPMInputFeed | Chassis 1 Power Shelf 1 Power Module 3 inputFeedA inputFeedB not supplying power | tmnxPhysChassisPMInputFeedClr |
| 7-2194-1 | tmnxPhysChassisFilterDoorOpen | Filter door is missing or open | tmnxPhysChassisFilterDoorClosed |
| 7-2196-1 | tmnxPhysChassisPMOverTemp | Chassis 1 Power Shelf 1 over temperature | tmnxPhysChassisPMOverTempClr |
| 7-2203-x | same as 7-2019-x but for SyncE | same as 7-2019-x but for SyncE | same as 7-2019-x but for SyncE |
| 7-2205-x | same as 7-2019-x but for E2 | same as 7-2019-x but for E2 | same as 7-2019-x but for E2 |
| 7-4001-1 | tmnxInterChassisCommsDown | Control communications disrupted between the Active CPM and the chassis | tmnxInterChassisCommsUp |
| 7-4003-1 | tmnxCpmlcPortDown | CPM Interconnect Port is not operational. Error code = invalid-connection | tmnxCpmlcPortUp |
| 7-4006-1 | tmnxCpmlcPortSFFRemoved | CPM interconnect port SFF removed | tmnxCpmlcPortSFFInserted |
| 7-4007-1 | tmnxCpmNoLocalIcPort | CPM A cannot reach the chassis using its local CPM interconnect ports | tmnxCpmLocalIcPortAvail |
| 7-4017-1 | tmnxSfmlcPortDown | SFM interconnect Port is not operational. Error code = invalid-connection to Fabric 10 IcPort 2 | tmnxSfmlcPortUp |
| 7-6002-1 | tmnxPowerShelfCommsDown | Chassis 1 Power Shelf 1 lost communication with cpmA | tmnxPowerShelfCommsUp |

| Facility alarm | Facility alarm name/raising log event | Sample details string | Clearing log event |
|----------------|---------------------------------------|---|-------------------------------|
| 7-6005-1 | tmnxPowerShelfOutputStatus Down | Chassis 1 Power Shelf 2 output status switched to off | tmnxPowerShelfOutputStatus Up |

Table 60: Facility alarm name/raising log event, cause, effect and recovery

| Facility alarm | Facility alarm name/raising log event | Cause | Effect | Recovery |
|----------------|---------------------------------------|--|---|---|
| 295-2430-1 | tmnxPowerSupply FanFailed | The tmnxPowerSupplyFanFailed notification is generated when a fan within a particular power-supply has ceased to function normally. | Cooling to the power-supply may be reduced, potentially leading to overheating. | The power-supply should be replaced by one with fully-functioning fan elements. |
| 59-2004-1 | linkDown | A linkDown trap signifies that the SNMP entity, acting in an agent role, has detected that the ifOperStatus object for one of its communication links is about to enter the down state from some other state (but not from the not Present state). | The indicated interface is taken down. | If the ifAdminStatus is down then the interface state is deliberate and there is no recovery. If the ifAdminStatus is up then try to determine that cause of the interface going down: cable cut, distal end went down, and so on. |
| 64-2091-1 | tmnxSysLicense Invalid | Generated when the license becomes invalid for the reason specified in the log event/alarm. | The system reboots at the end of the time remaining. | Configure a valid license file location and filename. |
| 64-2092-1 | tmnxSysLicense ExpiresSoon | Generated when the license expires soon. | The system reboots at the end of the time remaining. | Configure a valid license file location and filename. |
| 64-2221-1 | tmnxSysStandby LicensingError | Generated when the standby detects a licensing failure. The reason is specified in tmnxSysLicenseErrorReason. | The standby CPM may not be synchronized and may be put into a failed state. | Configure a valid license file location and filename, given the value of tmnxSysLicenseErrorReason. |

| Facility alarm | Facility alarm name/raising log event | Cause | Effect | Recovery |
|----------------|---|---|--|--|
| 93-2006-1 | tmnxSatSyncIfTimHoldover | The tmnxSatSyncIfTimHoldover notification is generated when the synchronous equipment timing subsystem of the satellite transitions into a holdover state | The transmit timing of all synchronous interfaces on the satellite are no longer synchronous with the host. This could result in traffic loss. | Investigate the state of the two input timing references on the satellite and the links between the host and the satellite (the uplinks that drive them for failures). |
| 93-2008-1 | tmnxSatSyncIfTimRef1Alarm with attribute tmnxSyncIfTimingNotify Alarm == 'los(1)' | The tmnxSatSyncIfTimRef1Alarm notification is generated when an alarm condition on the first timing reference is detected. | If the other timing reference is free of faults, the satellite no longer has a backup timing reference. If the other timing reference also has a fault, the satellite is likely no longer synchronous with the host. | Investigate the state of the link between the host and the satellite (the uplink) that drives the first timing reference on the satellite for faults. |
| 93-2008-2 | tmnxSatSyncIfTimRef1Alarm with attribute tmnxSyncIfTimingNotify Alarm == 'oof(2)' | The same cause as 93-2008-1 | The same effect as 93-2008-1 | Investigate the state of the link between the host and the satellite (the uplink) that drives the first timing reference on the satellite for faults. |
| 93-2008-3 | tmnxSatSyncIfTimRef1Alarm with attribute tmnxSyncIfTimingNotify Alarm == 'oopir(3)' | The same cause as 93-2008-1 | The same effect as 93-2008-1 | Investigate the state of the link between the host and the satellite (the uplink) that drives the first timing reference on the satellite for faults. |
| 93-2010-x | same as 93-2008-x but for ref2 | The same cause as 93-2008-x but for ref2 | The same as 93-2008-x but for ref2 | The same as 93-2008-x but for ref2 |
| 7-2001-1 | tmnxEqCardFailure | Generated when one of the cards in a chassis has failed. The card type may be IOM (or XCM), MDA (or XMA), SFM, CCM, CPM, Compact Flash, and so on. The reason | The effect is dependent on the card that has failed. IOM (or XCM) or MDA (or XMA) failure causes a loss of service for all services running on that card. A fabric failure can impact traffic to and from all cards. | Before taking any recovery steps collect a tech-support file, then try resetting (clear) the card. If unsuccessful, try removing and re-inserting the card. If |

| Facility alarm | Facility alarm name/raising log event | Cause | Effect | Recovery |
|----------------|---------------------------------------|---|--|--|
| | | is indicated in the details of the log event or alarm, and also available in the tmnxChassis NotifyCardFailure Reason attribute included in the SNMP notification. | 7750 SR, 7450 ESS — If the IOM/IMM fails then the two associated MDAs for the slot also go down. 7950 XRS — If one out of two XMA fails in a XCM slot then the XCM remains up. If only one remaining operational XMA within a XCM slot fails, then the XCM goes into a booting operational state. | that does not work then replace the card. |
| 7-2003-1 | tmnxEqCard Removed | Generated when a card is removed from the chassis. The card type may be IOM (or XCM), MDA (or XMA), SFM, CCM, CPM, Compact Flash, and so on. | The effect is dependent on the card that has been removed. IOM (or XCM) or MDA (or XMA) removal causes a loss of service for all services running on that card. A fabric removal can impact traffic to and from all cards. | Before taking any recovery steps collect a tech-support file, then try re-inserting the card. If unsuccessful, replace the card. |
| 7-2004-1 | tmnxEqWrongCard | Generated when the wrong type of card is inserted into a slot of the chassis. Even though a card may be physically supported by the slot, it may have been administratively configured to allow only specific card types in a particular slot location. The card type may be IOM (or XCM), MDA (or XMA), SFM, CCM, CPM, Compact Flash, and so on. | The effect is dependent on the card that has been incorrectly inserted. Incorrect IOM (or XCM) or MDA (or XMA) insertion causes a loss of service for all services running on that card. | Insert the correct card into the correct slot, and ensure the slot is configured for the correct type of card. |
| 7-2005-1 | tmnxEnvTempToo High | Generated when the temperature sensor reading on an equipment | This could be causing intermittent errors and could | Remove or power off the affected cards, or improve the cooling to the node. More |

| Facility alarm | Facility alarm name/raising log event | Cause | Effect | Recovery |
|----------------|--|--|--|---|
| | | object is greater than its configured threshold. | also cause permanent damage to components. | powerful fan trays may also be required. |
| 7-2011-1 | tmnxEqPowerSupplyRemoved | Generated when: <ul style="list-style-type: none"> one of the power supplies is removed from the chassis low input voltage is detected. The operating voltage range for the 7750 SR-7/12 and the 7450 ESS-7/12 is -40 to -72 VDC. The alarm is raised if the system detects that the voltage of the power supply has dropped to -42.5 VDC. | Reduced power can cause intermittent errors and could also cause permanent damage to components. | Re-insert the power supply or raise the input voltage to above -42.5 VDC. |
| 7-2017-1 | tmnxEqSyncIfTimingHoldover | Generated when the synchronous equipment timing subsystem transitions into a holdover state. | Any node-timed ports have very slow frequency drift limited by the central clock oscillator stability. The oscillator meets the holdover requirements of a Stratum 3 and G.813 Option 1 clock. | Address issues with the central clock input references. |
| 7-2019-1 | tmnxEqSyncIfTimingRef1Alarm with attribute tmnxSyncIfTimingNotifyAlarm == 'los(1)' | Generated when an alarm condition on the first timing reference is detected. The type of alarm (los, oof, and so on) is indicated in the details of the log event or alarm, and is also available in the tmnxSyncIfTimingNotifyAlarm attribute included | Timing reference 1 cannot be used as a source of timing into the central clock. | Address issues with the signal associated with timing reference 1. |

| Facility alarm | Facility alarm name/raising log event | Cause | Effect | Recovery |
|----------------|---|---|--|--|
| | | in the SNMP notification. The SNMP notification has the same indexes as those of the tmnxCpmCard Table. | | |
| 7-2019-2 | tmnxEqSyncIfTimingRef1Alarm with attribute tmnxSynclfTimingNotify Alarm == 'oof(2)' | The same cause as 7-2019-1 | The same effect as 7-2019-1 | Address issues with the signal associated with timing reference 1. |
| 7-2019-3 | tmnxEqSyncIfTimingRef1Alarm with attribute tmnxSynclfTimingNotify Alarm == 'oopir(3)' | The same cause as 7-2019-1 | The same effect as 7-2019-1 | Address issues with the signal associated with timing reference 1. |
| 7-2021-x | same as 7-2019-x but for ref2 | The same cause as 7-2019-x but for the second timing reference | The same as 7-2019-x but for the second timing reference | The same as 7-2019-x but for the second timing reference |
| 7-2030-x | same as 7-2019-x but for the BITS input | The same cause as 7-2019-x but for the BITS timing reference | The same as 7-2019-x but for the BITS timing reference | The same as 7-2019-x but for the BITS timing reference |
| 7-2033-1 | tmnxChassisUpgradeInProgress | The tmnxChassisUp gradeInProgress notification is generated only after a CPM switchover occurs and the new active CPM is running new software, while the IOMs or XCMs are still running old software. This is the start of the upgrade process. The tmnxChassisUpgradeInProgress notification continues to be generated every | A software mismatch between the CPM and IOM or XCM is generally fine for a short duration (during an upgrade) but may not allow for correct long term operation. | Complete the upgrade of all IOMs or XCMs. |

| Facility alarm | Facility alarm name/raising log event | Cause | Effect | Recovery |
|----------------|--|--|---|---|
| | | 30 minutes while at least one IOM or XCM is still running older software. | | |
| 7-2073-x | same as 7-2019-x but for the BITS2 input | The same as 7-2019-x but for the BITS 2 timing reference | The same as 7-2019-x but for the BITS 2 timing reference | The same as 7-2019-x but for the BITS 2 timing reference |
| 7-2092-1 | tmnxEqPowerCapacityExceeded | Generated when a device needs power to boot, but there is not enough power capacity to support the device. | A non-powered device does not boot until the power capacity is increased to support the device. | Add a new power supply to the system, or change the faulty power supply with a working one. |
| 7-2094-1 | tmnxEqPowerLostCapacity | Generated when a power supply fails or is removed which puts the system in an overloaded situation. | Devices are powered off in order of lowest power priority until the available power capacity can support the powered devices. | Add a new power supply to the system, or change the faulty power supply with a working one. |
| 7-2096-1 | tmnxEqPowerOverloadState | Generated when the overloaded power capacity cannot support the power requirements and there are no further devices that can be powered off. | The system runs a risk of experiencing brownouts while the available power capacity does not meet the required power consumption. | Add power capacity or manually shutdown devices until the power capacity meets the power needs. |
| 7-2104-1 | tmnxEqLowSwitchFabricCap | The tmnxEqLowSwitchFabricCap alarm is generated when the total switch fabric capacity becomes less than the IOM capacity because of link failures. At least one of the taps on the IOM is below 100% capacity. | There is diminished switch fabric capacity to forward service-impacting information. | If the system does not self-recover, the IOM must be rebooted. |

| Facility alarm | Facility alarm name/raising log event | Cause | Effect | Recovery |
|----------------|---------------------------------------|---|--|---|
| 7-2134-1 | tmnxSync IfTimBITS2048khz Unsup | The tmnxSync IfTimBITS2048khz Unsup notification is generated when the value of tSync IfTimingAdmBITSIf Type is set to 'g703- 2048khz (5)' and the CPM does not meet the specifications for the 2048kHz BITS output signal under G.703. | The BITS input is not used as the Sync reference and the 2048kHz BITS output signal generated by the CPM is squelched. | Replace the CPM with one that is capable of generating the 2048k Hz BITS output signal, or set tSyncIfTiming AdmBITSIfType to a value other than 'g703-2048khz (5)'. |
| 7-2136-1 | tmnxEqMgmtEth RedStandbyRaise | The tmnxEqMgmt EthRedStandby Raise notification is generated when the active CPM's management Ethernet port goes operationally down and the standby CPM's management Ethernet port is operationally up and now serving as the system's management Ethernet port. | The management Ethernet port is no longer redundant. The node can be managed via the standby CPM's management Ethernet port only. | Bring the active CPM's management Ethernet port operationally up. |
| 7-2138-1 | tmnxEqPhysChass PowerSupOvrTmp | Generated when the temperature sensor reading on a power supply module is greater than its configured threshold. | This could be causing intermittent errors and could also cause permanent damage to components. | Remove or power off the affected power supply module or improve the cooling to the node. More powerful fan trays may also be required. The power supply itself may be faulty so replacement may be necessary. |
| 7-2140-1 | tmnxEqPhysChass PowerSupAcFail | Generated when an AC failure is detected on a power supply. | Reduced power can cause intermittent errors and could also cause permanent damage to components. | First try re-inserting the power supply. If unsuccessful, replace the power supply. |

| Facility alarm | Facility alarm name/raising log event | Cause | Effect | Recovery |
|----------------|---------------------------------------|---|--|--|
| 7-2142-1 | tmnxEqPhysChass PowerSupDcFail | Generated when an DC failure is detected on a power supply. | Reduced power can cause intermittent errors and could also cause permanent damage to components. | First try re-inserting the power supply. If unsuccessful, then replace the power supply. |
| 7-2144-1 | tmnxEqPhysChass PowerSupInFail | Generated when an input failure is detected on a power supply. | Reduced power can cause intermittent errors and could also cause permanent damage to components. | First try re-inserting the power supply. If that does not work, then replace the power supply. |
| 7-2146-1 | tmnxEqPhysChass PowerSupOutFail, | Generated when an output failure is detected on a power supply. | Reduced power can cause intermittent errors and could also cause permanent damage to components. | First try re-inserting the power supply. If that does not work, then replace the power supply. |
| 7-2148-1 | tmnxEqPhys ChassisFanFailure | Generated when one of the fans in a fan tray has failed. | This could cause the temperature to rise and result in intermittent errors and potentially permanent damage to components. | Replace the fan tray immediately, improve the cooling to the node, or reduce the heat being generated in the node by removing cards or powering down the node. |
| 7-2153-1 | tmnxCpmMemSize Mismatch | A tmnxCpmMem SizeMismatch notification is generated when the RAM memory size of the standby CPM (that is, tmnxChassis NotifyCpmCardSlot Num) is different from the active CPM (that is, tmnxChassis NotifyHwIndex). | There is an increased risk of the memory overflow on the standby CPM during the CPM switchover. | Use CPMs with the same memory size. |
| 7-2156-1 | tmnxPhysChass PwrSupWrgFanDir | The tmnxPhysChass PwrSupWrgFanDir Clr notification is generated when the airflow direction of the power supply's fan is corrected. | The fan is cooling the power supply in the correct direction. | No recovery required. |

| Facility alarm | Facility alarm name/raising log event | Cause | Effect | Recovery |
|----------------|---------------------------------------|---|---|--|
| 7-2157-1 | tmnxPhysChassPwrSupPemACRect | The tmnxPhysChassPwrSupPemACRect notification is generated if any one of the AC rectifiers for a power supply is in a failed state or is missing. | There is an increased risk of the power supply failing, causing insufficient power to the system. | Bring the AC rectifiers back online. |
| 7-2159-1 | tmnxPhysChassPwrSupInputFeed | The tmnxPhysChassPwrSupInputFeed notification is generated if any one of the input feeds for a power supply is not supplying power. | There is an increased risk of system power brown-outs or black-outs. | Restore all of the input feeds that are not supplying power. |
| 7-2161-1 | tmnxEqBpEpromFail | The tmnxEqBpEpromFail alarm is generated when the active CPM is no longer able to access any of backplane EPROMs because of a hardware defect. | The active CPM is at risk of failing to initialize after node reboot because of not being able to access the BP EPROM to read the chassis type. | The system does not self-recover and Nokia Support has to be contacted for further instructions. |
| 7-2163-1 | tmnxEqBpEpromWarning | The tmnxEqBpEpromWarning alarm is generated when the active CPM is no longer able to access one backplane EPROM because of a hardware defect but a redundant EPROM is present and accessible. | There is no effect on system operation. | No recovery action required. |
| 7-2165-1 | tmnxPhysChassisPCMIInputFeed | The tmnxPhysChassisPCMIInputFeed notification is generated if any one of the input feeds for a PCM has gone offline. | There is an increased risk of system power brown-outs or black-outs. | Restore all of the input feeds that are not supplying power. |

| Facility alarm | Facility alarm name/raising log event | Cause | Effect | Recovery |
|----------------|---------------------------------------|---|--|--|
| 7-2190-1 | tmnxPhysChassisPMOutFail | The tmnxPhysChassisPMOutFail notification is generated when an output failure occurs on the power module. | The power module is no longer operational. | Insert a new power module. |
| 7-2192-1 | tmnxPhysChassisPMInputFeed | The tmnxPhysChassisPMInputFeed notification is generated if any one of the input feeds for a power module is not supplying power. | There is an increased risk of system power brownouts or blackouts. | Restore all of the input feeds that are not supplying power. |
| 7-2194-1 | tmnxPhysChassisFilterDoorOpen | The tmnxPhysChassisFilterDoorOpen notification is generated when the filter door is either open or not present. | Power shelf protection may be compromised. | If the filter door is not installed, install it. Close the filter door. |
| 7-2196-1 | tmnxPhysChassisPMOverTemp | The tmnxPhysChassisPMOverTemp notification is generated when a power module's temperature surpasses the temperature threshold. | The power module is no longer operational. | Check input feed or insert a new power module. |
| 7-2203-x | same as 7-2019-x but for SyncE | The same cause as 7-2019-x but for SyncE | same as 7-2019-x but for SyncE | same as 7-2019-x but for SyncE |
| 7-2205-x | same as 7-2019-x but for E2 | The same cause as 7-2019-x but for E2 | same as 7-2019-x but for E2 | same as 7-2019-x but for E2 |
| 7-4001-1 | tmnxInterChassisCommsDown | The tmnxInterChassisCommsDown alarm is generated when the active CPM cannot reach the far-end chassis. | The resources on the far-end chassis are not available. This event for the far-end chassis means that the CPM, SFM, and XCM cards in the far-end chassis reboot and remain operationally | Ensure that all CPM interconnect ports in the system are properly cabled together with working cables. |

| Facility alarm | Facility alarm name/raising log event | Cause | Effect | Recovery |
|----------------|---------------------------------------|---|---|--|
| | | | down until communications are re-established. | |
| 7-4003-1 | tmnxCpmIcPort Down | The tmnxCpmIcPort Down alarm is generated when the CPM interconnect port is not operational. The reason may be a cable connected incorrectly, a disconnected cable, a faulty cable, or a misbehaving CPM interconnect port or card. | At least one of the control plane paths used for inter-chassis CPM communication is not operational. Other paths may be available. | A manual verification and testing of each CPM interconnect port is required to ensure fully functional operation. Physical replacement of cabling may be required. |
| 7-4006-1 | tmnxCpmIcPortSFFRemoved | The tmnxCpmIcPortSFFRemoved notification is generated when the SFF (eg. QSFP) is removed from the CPM interconnect port. Removing an SFF causes both this trap, and also a tmnxCpmIcPort Down event. | Removing the SFF causes the CPM interconnect port to go down. This port is no longer able to be used as part of the control plane between chassis but other paths may be available. | Insert a working SFF into the port. |
| 7-4007-1 | tmnxCpmNoLocalIcPort | The tmnxCpmNoLocalIcPort alarm is generated when the CPM cannot reach the other chassis using its local CPM interconnect ports. | Another control communications path may still be available between the CPM and the other chassis via the mate CPM in the same chassis. If that alternative path is not available then complete disruption of control communications to the other chassis occurs and the tmnxInterChassisComms Down alarm is raised. A tmnxCpmNoLocalIcPort alarm on the active CPM indicates that a further failure of the local CPM | Ensure that all CPM interconnect ports in the system are properly cabled together with working cables. |

| Facility alarm | Facility alarm name/raising log event | Cause | Effect | Recovery |
|----------------|---------------------------------------|--|--|--|
| | | | interconnect ports on the standby CPM causes complete disruption of control communications to the other chassis and the tmnxInterChassisComms Down alarm is raised. A tmnxCpmNoLocalCPort alarm on the standby CPM indicates that a CPM switchover may cause temporary disruption of control communications to the other chassis while the rebooting CPM comes back into service. | |
| 7-4017-1 | tmnxSfmIcPort Down | The tmnxSfmIcPortDown alarm is generated when the SFM interconnect port is not operational. The reason may be a cable connected incorrectly, a disconnected cable, a faulty cable, or a misbehaving SFM interconnect port or SFM card. | This port can no longer be used as part of the user plane fabric between chassis. Other fabric paths may be available resulting in no loss of capacity. | A manual verification and testing of each SFM interconnect port is required to ensure fully functional operation. Physical replacement of cabling may be required. |
| 7-6002-1 | tmnxPowerShelf CommsDown | The tmnxPowerShelfCommsDown is generated when there is a loss of communications with the power shelf controller. | If there is a power failure, it is not detected because the power modules cannot be polled. The system continues to report the state of the power modules as they were when last seen. | Correct the power shelf controller communications problem. |
| 7-6005-1 | tmnxPowerShelf OutputStatusDown | The tmnxPowerShelfOutputStatusSwitch is generated when the physical output switch on the power shelf is set to Standby. | The power output from the identified power shelf is switched off and does not supply power to the system. | Set output switch to On to restore power output. |

Table 61: ESA facility alarm, facility alarm name, raising log event, sample details string, and clearing log event and Table 62: ESA facility alarm name/raising log event, cause, effect, and recovery show the supported ESA facility alarms.

Table 61: ESA facility alarm, facility alarm name, raising log event, sample details string, and clearing log event

| ESA Event and states | Facility Alarm | Severity | Facility alarm name/raising log event | Sample details string | Clearing log event |
|-----------------------------------|----------------|----------|---------------------------------------|--|-------------------------------|
| ESA HW Status: degraded | 2400-1 | Major | tmnxEsaHwStatusDegraded | ESA 3 aggregate hardware status degraded | tmnxEsaHwStatusDegradedClr |
| ESA HW Status: critical | 2402-1 | Critical | tmnxEsaHwStatusCritical | ESA 3 aggregate hardware status critical | tmnxEsaHwStatusCriticalClr |
| ESA HW Power Supply 1 Degraded | 2404-1 | Critical | tmnxEsaHwPwrSup1Degraded | ESA 3 power supply 1 status degraded | tmnxEsaHwPwrSup1DegradedClr |
| ESA HW Power Supply 1 Failed | 2406-1 | Critical | tmnxEsaHwPwrSup1Failed | ESA 3 power supply 1 status failed | tmnxEsaHwPwrSup1FailedClr |
| ESA HW Power Supply 2 Degraded | 2408-1 | Critical | tmnxEsaHwPwrSup2Degraded | ESA 3 power supply 2 status degraded | tmnxEsaHwPwrSup2DegradedClr |
| ESA HW Power Supply 2 Failed | 2410-1 | Critical | tmnxEsaHwPwrSup2Failed | ESA 3 power supply 2 status failed | tmnxEsaHwPwrSup2FailedClr |
| ESA HW Fan Bank Non Redundant | 2412-1 | Major | tmnxEsaHwFanBankNonRedun | ESA 3 fan bank redundancy degraded | tmnxEsaHwFanBankNonRedunClr |
| ESA HW Fan Bank Failed Redundancy | 2414-1 | Critical | tmnxEsaHwFanBankFailRedun | ESA 3 fan bank redundancy failed | tmnxEsaHwFanBankFailRedunClr |
| ESA HW Fan Status Degraded | 2416-1 | Critical | tmnxEsaHwFanStatusDegraded | ESA 3 fan status degraded | tmnxEsaHwFanStatusDegradedClr |
| ESA HW Fan Status Failed | 2418-1 | Critical | tmnxEsaHwFanStatusFailed | ESA 3 fan status failed | tmnxEsaHwFanStatusFailedClr |

| ESA Event and states | Facility Alarm | Severity | Facility alarm name/raising log event | Sample details string | Clearing log event |
|--|----------------|----------|---------------------------------------|---|----------------------------------|
| ESA HW Power Supply Mismatch | 2420-1 | Major | tmnxEsaHwPwrSup Mismatch | ESA 3 power supply mismatch | tmnxEsaHwPwrSup MismatchClr |
| ESA HW Power Supply Bank Non Redundant | 2422-1 | Major | tmnxEsaHwPwrSupBank NonRedun | ESA 3 power supply bank redundancy degraded | tmnxEsaHwPwrSupBank NonRedunClr |
| ESA HW Temperature Degraded | 2426-1 | Critical | tmnxEsaHwTemperature Degraded | ESA 3 temperature status degraded | tmnxEsaHwTemperature DegradedClr |
| ESA HW Temperature Failed | 2428-1 | Critical | tmnxEsaHwTemperature Failed | ESA 3 temperature status failed | tmnxEsaHwTemperature FailedClr |

Table 62: ESA facility alarm name/raising log event, cause, effect, and recovery

| Facility Alarm | Facility alarm name/raising log event | Cause | Effect | Recovery |
|----------------|---------------------------------------|---|--|--------------------------------|
| 2400-1 | tmnxEsaHwStatusDegraded | Generated when the ESA hardware status is degraded | Service may be affected | Contact Nokia customer support |
| 2402-1 | tmnxEsaHwStatusCritical | Generated when one or more ESA hardware statuses are critical | Service may be affected | Contact Nokia customer support |
| 2404-1 | tmnxEsaHwPwr Sup1Degraded | Generated when the ESA power supply 1 is degraded | Power supply and redundancy are affected. ESA operation may be affected. | Contact Nokia customer support |
| 2406-1 | tmnxEsaHwPwrSup1Failed | Generated when the ESA power supply 1 fails | Power supply and redundancy are affected. ESA operation may be affected. | Contact Nokia customer support |
| 2408-1 | tmnxEsaHwPwr Sup2Degraded | Generated when the ESA power supply 2 is degraded | Power supply operation and reliability may be affected | Contact Nokia customer support |

| Facility Alarm | Facility alarm name/raising log event | Cause | Effect | Recovery |
|----------------|---------------------------------------|---|--|--|
| 2410-1 | tmnxEsaHwPwrSup2Failed | Generated when the ESA power supply 2 fails | Power supply and redundancy are affected. ESA operation may be affected. | Contact Nokia customer support |
| 2412-1 | tmnxEsaHwFanBankNon Redun | Generated when 1 to 6 of the 7 fans are failed | ESA cooling may be inadequate | Contact Nokia customer support |
| 2414-1 | tmnxEsaHwFanBankFail Redun | Generated when all 7 fans are failed | ESA cooling is inadequate, the ESA may shut down | Contact Nokia customer support |
| 2416-1 | tmnxEsaHwFanStatus Degraded | Generated when one or more ESA fans are degraded | ESA cooling may be inadequate | Contact Nokia customer support |
| 2418-1 | tmnxEsaHwFanStatusFailed | Generated when one or more ESA fans fail | ESA cooling may be inadequate | Contact Nokia customer support |
| 2420-1 | tmnxEsaHwPwrSupMismatch | Generated when the ESA power supplies do not match | ESA power supplies must be matched | Equip the ESA with matching power supplies |
| 2422-1 | tmnxEsaHwPwrSupBankNon Redun | Generated when one ESA power supply has failed and the other is running | ESA will fail if another power supply failure occurs | Contact Nokia customer support |
| 2426-1 | tmnxEsaHwTemperature Degraded | Generated when one or more ESA temperatures is outside the expected operating range | If the ESA temperature remains outside the expected operating range, the ESA may shut down | The ESA may need maintenance to rectify the issue. Contact Nokia customer support. |
| 2428-1 | tmnxEsaHwTemperature Failed | Generated when the ESA temperature is critical | If the ESA temperature remains outside the expected operating range, the ESA may shut down | The ESA may need maintenance to rectify the issue. Contact Nokia customer support. |

The linkDown Facility Alarm is supported for the objects listed in [Table 63: linkDown Facility Alarm support](#) (note that all objects may not be supported on all platforms):

Table 63: linkDown Facility Alarm support

| Object | Supported |
|--|-----------|
| Ethernet Ports | Yes |
| Sonet Section, Line and Path (POS) | Yes |
| TDM Ports (E1, T1, DS3) including CES MDAs | Yes |
| TDM Channels (DS3 channel configured in an STM-1 port) | Yes |
| Ethernet LAGs | No |
| APS groups | No |
| Ethernet VLANs | No |

14.6 Configuring facility alarms with CLI

This section provides information to configure facility alarms using the command line interface.

14.6.1 Enabling facility alarms

The following example shows how to enable facility alarms.

Example: MD-CLI

```
[ex:/configure system alarms]
A:admin@node-2# info
    admin-state enable
```

Example: classic CLI

```
A:node-2>config>system# alarms
#-----
    no shutdown
    exit
-----
```

14.6.2 Common configuration tasks

14.6.2.1 Configuring the maximum number of alarms to clear

You can configure the number of entries to keep in the list of cleared alarms. Use the following command to configure the maximum number of cleared alarms to keep.

```
configure system alarms max-cleared
```

Example: MD-CLI

```
[ex:/configure system alarms]
A:admin@node-2# info
    max-cleared 100
```

Example: classic CLI

```
*A:node-2>config>system>alarms# max-cleared 100
A:node-2>config>system>alarms# info
-----
                max-cleared 100
-----
```

15 Standards and protocol support

**Note:**

The information provided in this chapter is subject to change without notice and may not apply to all platforms.

Nokia assumes no responsibility for inaccuracies.

15.1 Access Node Control Protocol (ANCP)

draft-ietf-ancp-protocol-02, *Protocol for Access Node Control Mechanism in Broadband Networks*

RFC 5851, *Framework and Requirements for an Access Node Control Mechanism in Broadband Multi-Service Networks*

15.2 Bidirectional Forwarding Detection (BFD)

draft-ietf-lsr-ospf-bfd-strict-mode-10, *OSPF BFD Strict-Mode*

RFC 5880, *Bidirectional Forwarding Detection (BFD)*

RFC 5881, *Bidirectional Forwarding Detection (BFD) IPv4 and IPv6 (Single Hop)*

RFC 5882, *Generic Application of Bidirectional Forwarding Detection (BFD)*

RFC 5883, *Bidirectional Forwarding Detection (BFD) for Multihop Paths*

RFC 7130, *Bidirectional Forwarding Detection (BFD) on Link Aggregation Group (LAG) Interfaces*

RFC 7880, *Seamless Bidirectional Forwarding Detection (S-BFD)*

RFC 7881, *Seamless Bidirectional Forwarding Detection (S-BFD) for IPv4, IPv6, and MPLS*

RFC 7883, *Advertising Seamless Bidirectional Forwarding Detection (S-BFD) Discriminators in IS-IS*

RFC 7884, *OSPF Extensions to Advertise Seamless Bidirectional Forwarding Detection (S-BFD) Target Discriminators*

RFC 9247, *BGP - Link State (BGP-LS) Extensions for Seamless Bidirectional Forwarding Detection (S-BFD)*

15.3 Border Gateway Protocol (BGP)

draft-gredler-idr-bgplu-epe-14, *Egress Peer Engineering using BGP-LU*

draft-hares-idr-update-attrib-low-bits-fix-01, *Update Attribute Flag Low Bits Clarification*

draft-ietf-idr-add-paths-guidelines-08, *Best Practices for Advertisement of Multiple Paths in IBGP*

draft-ietf-idr-best-external-03, *Advertisement of the best external route in BGP*

draft-ietf-idr-bgp-flowspec-oid-03, *Revised Validation Procedure for BGP Flow Specifications*
draft-ietf-idr-bgp-gr-notification-01, *Notification Message support for BGP Graceful Restart*
draft-ietf-idr-bgp-ls-app-specific-attr-16, *Application-Specific Attributes Advertisement with BGP Link-State*
draft-ietf-idr-bgp-ls-flex-algo-06, *Flexible Algorithm Definition Advertisement with BGP Link-State*
draft-ietf-idr-bgp-optimal-route-reflection-10, *BGP Optimal Route Reflection (BGP-ORR)*
draft-ietf-idr-error-handling-03, *Revised Error Handling for BGP UPDATE Messages*
draft-ietf-idr-flowspec-interfaceset-03, *Applying BGP flowspec rules on a specific interface set*
draft-ietf-idr-flowspec-path-redirect-05, *Flowspec Indirection-id Redirect – localised ID*
draft-ietf-idr-flowspec-redirect-ip-02, *BGP Flow-Spec Redirect to IP Action*
draft-ietf-idr-link-bandwidth-03, *BGP Link Bandwidth Extended Community*
draft-ietf-idr-long-lived-gr-00, *Support for Long-lived BGP Graceful Restart*
RFC 1772, *Application of the Border Gateway Protocol in the Internet*
RFC 1997, *BGP Communities Attribute*
RFC 2385, *Protection of BGP Sessions via the TCP MD5 Signature Option*
RFC 2439, *BGP Route Flap Damping*
RFC 2545, *Use of BGP-4 Multiprotocol Extensions for IPv6 Inter-Domain Routing*
RFC 2858, *Multiprotocol Extensions for BGP-4*
RFC 2918, *Route Refresh Capability for BGP-4*
RFC 4271, *A Border Gateway Protocol 4 (BGP-4)*
RFC 4360, *BGP Extended Communities Attribute*
RFC 4364, *BGP/MPLS IP Virtual Private Networks (VPNs)*
RFC 4456, *BGP Route Reflection: An Alternative to Full Mesh Internal BGP (IBGP)*
RFC 4486, *Subcodes for BGP Cease Notification Message*
RFC 4659, *BGP-MPLS IP Virtual Private Network (VPN) Extension for IPv6 VPN*
RFC 4684, *Constrained Route Distribution for Border Gateway Protocol/MultiProtocol Label Switching (BGP/MPLS) Internet Protocol (IP) Virtual Private Networks (VPNs)*
RFC 4724, *Graceful Restart Mechanism for BGP – helper mode*
RFC 4760, *Multiprotocol Extensions for BGP-4*
RFC 4798, *Connecting IPv6 Islands over IPv4 MPLS Using IPv6 Provider Edge Routers (6PE)*
RFC 5004, *Avoid BGP Best Path Transitions from One External to Another*
RFC 5065, *Autonomous System Confederations for BGP*
RFC 5291, *Outbound Route Filtering Capability for BGP-4*
RFC 5396, *Textual Representation of Autonomous System (AS) Numbers – asplain*
RFC 5492, *Capabilities Advertisement with BGP-4*
RFC 5668, *4-Octet AS Specific BGP Extended Community*
RFC 6286, *Autonomous-System-Wide Unique BGP Identifier for BGP-4*

RFC 6368, *Internal BGP as the Provider/Customer Edge Protocol for BGP/MPLS IP Virtual Private Networks (VPNs)*

RFC 6793, *BGP Support for Four-Octet Autonomous System (AS) Number Space*

RFC 6810, *The Resource Public Key Infrastructure (RPKI) to Router Protocol*

RFC 6811, *Prefix Origin Validation*

RFC 6996, *Autonomous System (AS) Reservation for Private Use*

RFC 7311, *The Accumulated IGP Metric Attribute for BGP*

RFC 7606, *Revised Error Handling for BGP UPDATE Messages*

RFC 7607, *Codification of AS 0 Processing*

RFC 7674, *Clarification of the Flowspec Redirect Extended Community*

RFC 7752, *North-Bound Distribution of Link-State and Traffic Engineering (TE) Information Using BGP*

RFC 7854, *BGP Monitoring Protocol (BMP)*

RFC 7911, *Advertisement of Multiple Paths in BGP*

RFC 7999, *BLACKHOLE Community*

RFC 8092, *BGP Large Communities Attribute*

RFC 8097, *BGP Prefix Origin Validation State Extended Community*

RFC 8212, *Default External BGP (EBGP) Route Propagation Behavior without Policies*

RFC 8277, *Using BGP to Bind MPLS Labels to Address Prefixes*

RFC 8571, *BGP - Link State (BGP-LS) Advertisement of IGP Traffic Engineering Performance Metric Extensions*

RFC 8950, *Advertising IPv4 Network Layer Reachability Information (NLRI) with an IPv6 Next Hop*

RFC 8955, *Dissemination of Flow Specification Rules*

RFC 8956, *Dissemination of Flow Specification Rules for IPv6*

RFC 9086, *Border Gateway Protocol - Link State (BGP-LS) Extensions for Segment Routing BGP Egress Peer Engineering*

15.4 Bridging and management

IEEE 802.1AB, *Station and Media Access Control Connectivity Discovery*

IEEE 802.1ad, *Provider Bridges*

IEEE 802.1ag, *Connectivity Fault Management*

IEEE 802.1ah, *Provider Backbone Bridges*

IEEE 802.1ak, *Multiple Registration Protocol*

IEEE 802.1aq, *Shortest Path Bridging*

IEEE 802.1AX, *Link Aggregation*

IEEE 802.1D, *MAC Bridges*

IEEE 802.1p, *Traffic Class Expediting*

IEEE 802.1Q, *Virtual LANs*
IEEE 802.1s, *Multiple Spanning Trees*
IEEE 802.1w, *Rapid Reconfiguration of Spanning Tree*
IEEE 802.1X, *Port Based Network Access Control*

15.5 Broadband Network Gateway (BNG) Control and User Plane Separation (CUPS)

3GPP TS 23.003, *Numbering, addressing and identification*
3GPP TS 23.007, *Restoration procedures*
3GPP TS 23.501, *System architecture for the 5G System (5GS)*
3GPP TS 23.502, *Procedures for the 5G System (5GS)*
3GPP TS 23.503, *Policy and charging control framework for the 5G System (5GS)*
3GPP TS 24.501, *Non-Access-Stratum (NAS) protocol for 5G System (5GS)*
3GPP TS 29.244, *Interface between the Control Plane and the User Plane nodes*
3GPP TS 29.281, *General Packet Radio System (GPRS) Tunnelling Protocol User Plane (GTPv1-U)*
3GPP TS 29.500, *Technical Realization of Service Based Architecture*
3GPP TS 29.501, *Principles and Guidelines for Services Definition*
3GPP TS 29.502, *Session Management Services*
3GPP TS 29.503, *Unified Data Management Services*
3GPP TS 29.512, *Session Management Policy Control Service*
3GPP TS 29.518, *Access and Mobility Management Services*
3GPP TS 32.255, *5G data connectivity domain charging*
3GPP TS 32.290, *Services, operations and procedures of charging using Service Based Interface (SBI)*
3GPP TS 32.291, *5G system, charging service*
BBF TR-459, *Control and User Plane Separation for a Disaggregated BNG*
BBF TR-459.2, *Multi-Service Disaggregated BNG with CUPS: Integrated Carrier Grade NAT function*
RFC 8300, *Network Service Header (NSH)*

15.6 Certificate management

RFC 4210, *Internet X.509 Public Key Infrastructure Certificate Management Protocol (CMP)*
RFC 4211, *Internet X.509 Public Key Infrastructure Certificate Request Message Format (CRMF)*
RFC 5280, *Internet X.509 Public Key Infrastructure Certificate and Certificate Revocation List (CRL) Profile*
RFC 6712, *Internet X.509 Public Key Infrastructure -- HTTP Transfer for the Certificate Management Protocol (CMP)*

RFC 7030, *Enrollment over Secure Transport*

RFC 7468, *Textual Encodings of PKIX, PKCS, and CMS Structures*

15.7 Circuit emulation

RFC 4553, *Structure-Agnostic Time Division Multiplexing (TDM) over Packet (SAToP)*

RFC 5086, *Structure-Aware Time Division Multiplexed (TDM) Circuit Emulation Service over Packet Switched Network (CESoPSN)*

RFC 5287, *Control Protocol Extensions for the Setup of Time-Division Multiplexing (TDM) Pseudowires in MPLS Networks*

15.8 Ethernet

IEEE 802.3ah, *Media Access Control Parameters, Physical Layers, and Management Parameters for Subscriber Access Networks*

IEEE 802.3x, *Ethernet Flow Control*

ITU-T G.8031/Y.1342, *Ethernet Linear Protection Switching*

ITU-T G.8032/Y.1344, *Ethernet Ring Protection Switching*

ITU-T Y.1731, *OAM functions and mechanisms for Ethernet based networks*

15.9 Ethernet VPN (EVPN)

draft-ietf-bess-evpn-ipvpn-interworking-06, *EVPN Interworking with IPVPN*

draft-ietf-bess-evpn-irb-mcast-04, *EVPN Optimized Inter-Subnet Multicast (OISM) Forwarding – ingress replication*

draft-ietf-bess-evpn-pref-df-06, *Preference-based EVPN DF Election*

draft-ietf-bess-evpn-unequal-lb-16, *Weighted Multi-Path Procedures for EVPN Multi-Homing – section 9*

draft-ietf-bess-evpn-virtual-eth-segment-06, *EVPN Virtual Ethernet Segment*

draft-ietf-bess-pbb-evpn-isid-cmacflush-00, *PBB-EVPN ISID-based CMAC-Flush*

draft-sajassi-bess-evpn-ip-aliasing-05, *EVPN Support for L3 Fast Convergence and Aliasing/Backup Path – IP Prefix routes*

draft-sr-bess-evpn-vpws-gateway-03, *Ethernet VPN Virtual Private Wire Services Gateway Solution*

draft-trr-bess-bgp-srv6-args-02, *SRv6 Argument Signaling for BGP Services*

RFC 7432, *BGP MPLS-Based Ethernet VPN*

RFC 7623, *Provider Backbone Bridging Combined with Ethernet VPN (PBB-EVPN)*

RFC 8214, *Virtual Private Wire Service Support in Ethernet VPN*

RFC 8317, *Ethernet-Tree (E-Tree) Support in Ethernet VPN (EVPN) an Provider Backbone Bridging EVPN (PBB-EVPN)*

RFC 8365, *A Network Virtualization Overlay Solution Using Ethernet VPN (EVPN)*
RFC 8560, *Seamless Integration of Ethernet VPN (EVPN) with Virtual Private LAN Service (VPLS) and Their Provider Backbone Bridge (PBB) Equivalents*
RFC 8584, *DF Election and AC-influenced DF Election*
RFC 9047, *Propagation of ARP/ND Flags in an Ethernet Virtual Private Network (EVPN)*
RFC 9135, *Integrated Routing and Bridging in Ethernet VPN (EVPN) – Asymmetric IRB Procedures and Mobility Procedure*
RFC 9136, *IP Prefix Advertisement in Ethernet VPN (EVPN)*
RFC 9161, *Operational Aspects of Proxy ARP/ND in Ethernet Virtual Private Networks*
RFC 9251, *Internet Group Management Protocol (IGMP) and Multicast Listener Discovery (MLD) Proxies for Ethernet VPN (EVPN)*

15.10 gRPC Remote Procedure Calls (gRPC)

cert.proto version 0.1.0, *gRPC Network Operations Interface (gNOI) Certificate Management Service*
file.proto version 0.1.0, *gRPC Network Operations Interface (gNOI) File Service*
gnmi.proto version 0.8.0, *gRPC Network Management Interface (gNMI) Service Specification*
PROTOCOL-HTTP2, *gRPC over HTTP2*
system.proto Version 1.0.0, *gRPC Network Operations Interface (gNOI) System Service*

15.11 Intermediate System to Intermediate System (IS-IS)

draft-ietf-isis-mi-02, *IS-IS Multi-Instance*
draft-kaplan-isis-ext-eth-02, *Extended Ethernet Frame Size Support*
ISO/IEC 10589:2002 Second Edition, *Intermediate system to Intermediate system intra-domain routing information exchange protocol for use in conjunction with the protocol for providing the connectionless-mode Network Service (ISO 8473)*
RFC 1195, *Use of OSI IS-IS for Routing in TCP/IP and Dual Environments*
RFC 2973, *IS-IS Mesh Groups*
RFC 3359, *Reserved Type, Length and Value (TLV) Codepoints in Intermediate System to Intermediate System*
RFC 3719, *Recommendations for Interoperable Networks using Intermediate System to Intermediate System (IS-IS)*
RFC 3787, *Recommendations for Interoperable IP Networks using Intermediate System to Intermediate System (IS-IS)*
RFC 5120, *M-ISIS: Multi Topology (MT) Routing in IS-IS*
RFC 5130, *A Policy Control Mechanism in IS-IS Using Administrative Tags*
RFC 5301, *Dynamic Hostname Exchange Mechanism for IS-IS*
RFC 5302, *Domain-wide Prefix Distribution with Two-Level IS-IS*

RFC 5303, *Three-Way Handshake for IS-IS Point-to-Point Adjacencies*
RFC 5304, *IS-IS Cryptographic Authentication*
RFC 5305, *IS-IS Extensions for Traffic Engineering TE*
RFC 5306, *Restart Signaling for IS-IS – helper mode*
RFC 5308, *Routing IPv6 with IS-IS*
RFC 5309, *Point-to-Point Operation over LAN in Link State Routing Protocols*
RFC 5310, *IS-IS Generic Cryptographic Authentication*
RFC 6119, *IPv6 Traffic Engineering in IS-IS*
RFC 6213, *IS-IS BFD-Enabled TLV*
RFC 6232, *Purge Originator Identification TLV for IS-IS*
RFC 6233, *IS-IS Registry Extension for Purges*
RFC 6329, *IS-IS Extensions Supporting IEEE 802.1aq Shortest Path Bridging*
RFC 7775, *IS-IS Route Preference for Extended IP and IPv6 Reachability*
RFC 7794, *IS-IS Prefix Attributes for Extended IPv4 and IPv6 Reachability – sections 2.1 and 2.3*
RFC 7981, *IS-IS Extensions for Advertising Router Information*
RFC 7987, *IS-IS Minimum Remaining Lifetime*
RFC 8202, *IS-IS Multi-Instance – single topology*
RFC 8570, *IS-IS Traffic Engineering (TE) Metric Extensions – Min/Max Unidirectional Link Delay metric for flex-algo, RSVP, SR-TE*
RFC 8919, *IS-IS Application-Specific Link Attributes*

15.12 Internet Protocol (IP) Fast Reroute (FRR)

draft-ietf-rtgwg-lfa-manageability-08, *Operational management of Loop Free Alternates*
RFC 5286, *Basic Specification for IP Fast Reroute: Loop-Free Alternates*
RFC 7431, *Multicast-Only Fast Reroute*
RFC 7490, *Remote Loop-Free Alternate (LFA) Fast Reroute (FRR)*
RFC 8518, *Selection of Loop-Free Alternates for Multi-Homed Prefixes*

15.13 Internet Protocol (IP) general

draft-grant-tacacs-02, *The TACACS+ Protocol*
RFC 768, *User Datagram Protocol*
RFC 793, *Transmission Control Protocol*
RFC 854, *Telnet Protocol Specifications*
RFC 1350, *The TFTP Protocol (revision 2)*

RFC 2347, *TFTP Option Extension*
RFC 2348, *TFTP Blocksize Option*
RFC 2349, *TFTP Timeout Interval and Transfer Size Options*
RFC 2428, *FTP Extensions for IPv6 and NATs*
RFC 2617, *HTTP Authentication: Basic and Digest Access Authentication*
RFC 2784, *Generic Routing Encapsulation (GRE)*
RFC 2818, *HTTP Over TLS*
RFC 2890, *Key and Sequence Number Extensions to GRE*
RFC 3164, *The BSD syslog Protocol*
RFC 4250, *The Secure Shell (SSH) Protocol Assigned Numbers*
RFC 4251, *The Secure Shell (SSH) Protocol Architecture*
RFC 4252, *The Secure Shell (SSH) Authentication Protocol – publickey, password*
RFC 4253, *The Secure Shell (SSH) Transport Layer Protocol*
RFC 4254, *The Secure Shell (SSH) Connection Protocol*
RFC 4511, *Lightweight Directory Access Protocol (LDAP): The Protocol*
RFC 4513, *Lightweight Directory Access Protocol (LDAP): Authentication Methods and Security Mechanisms – TLS*
RFC 4632, *Classless Inter-domain Routing (CIDR): The Internet Address Assignment and Aggregation Plan*
RFC 5082, *The Generalized TTL Security Mechanism (GTSM)*
RFC 5246, *The Transport Layer Security (TLS) Protocol Version 1.2 – TLS client, RSA public key*
RFC 5425, *Transport Layer Security (TLS) Transport Mapping for Syslog – RFC 3164 with TLS*
RFC 5656, *Elliptic Curve Algorithm Integration in the Secure Shell Transport Layer – ECDSA*
RFC 5925, *The TCP Authentication Option*
RFC 5926, *Cryptographic Algorithms for the TCP Authentication Option (TCP-AO)*
RFC 6398, *IP Router Alert Considerations and Usage – MLD*
RFC 6528, *Defending against Sequence Number Attacks*
RFC 7011, *Specification of the IP Flow Information Export (IPFIX) Protocol for the Exchange of Flow Information*
RFC 7012, *Information Model for IP Flow Information Export*
RFC 7230, *Hypertext Transfer Protocol (HTTP/1.1): Message Syntax and Routing*
RFC 7231, *Hypertext Transfer Protocol (HTTP/1.1): Semantics and Content*
RFC 7232, *Hypertext Transfer Protocol (HTTP/1.1): Conditional Requests*
RFC 7301, *Transport Layer Security (TLS) Application Layer Protocol Negotiation Extension*
RFC 7616, *HTTP Digest Access Authentication*
RFC 8446, *The Transport Layer Security (TLS) Protocol Version 1.3*

15.14 Internet Protocol (IP) multicast

cisco-ipmulticast/pim-autorp-spec01, *Auto-RP: Automatic discovery of Group-to-RP mappings for IP multicast* – version 1

draft-ietf-bier-pim-signaling-08, *PIM Signaling Through BIER Core*

draft-ietf-idmr-traceroute-ipm-07, *A "traceroute" facility for IP Multicast*

draft-ietf-l2vpn-vpls-pim-snooping-07, *Protocol Independent Multicast (PIM) over Virtual Private LAN Service (VPLS)*

RFC 1112, *Host Extensions for IP Multicasting*

RFC 2236, *Internet Group Management Protocol, Version 2*

RFC 2365, *Administratively Scoped IP Multicast*

RFC 2375, *IPv6 Multicast Address Assignments*

RFC 2710, *Multicast Listener Discovery (MLD) for IPv6*

RFC 3306, *Unicast-Prefix-based IPv6 Multicast Addresses*

RFC 3376, *Internet Group Management Protocol, Version 3*

RFC 3446, *Anycast Rendezvous Point (RP) mechanism using Protocol Independent Multicast (PIM) and Multicast Source Discovery Protocol (MSDP)*

RFC 3590, *Source Address Selection for the Multicast Listener Discovery (MLD) Protocol*

RFC 3618, *Multicast Source Discovery Protocol (MSDP)*

RFC 3810, *Multicast Listener Discovery Version 2 (MLDv2) for IPv6*

RFC 3956, *Embedding the Rendezvous Point (RP) Address in an IPv6 Multicast Address*

RFC 3973, *Protocol Independent Multicast - Dense Mode (PIM-DM): Protocol Specification (Revised) – auto-RP groups*

RFC 4541, *Considerations for Internet Group Management Protocol (IGMP) and Multicast Listener Discovery (MLD) Snooping Switches*

RFC 4604, *Using Internet Group Management Protocol Version 3 (IGMPv3) and Multicast Listener Discovery Protocol Version 2 (MLDv2) for Source-Specific Multicast*

RFC 4607, *Source-Specific Multicast for IP*

RFC 4608, *Source-Specific Protocol Independent Multicast in 232/8*

RFC 4610, *Anycast-RP Using Protocol Independent Multicast (PIM)*

RFC 4611, *Multicast Source Discovery Protocol (MSDP) Deployment Scenarios*

RFC 5059, *Bootstrap Router (BSR) Mechanism for Protocol Independent Multicast (PIM)*

RFC 5186, *Internet Group Management Protocol Version 3 (IGMPv3) / Multicast Listener Discovery Version 2 (MLDv2) and Multicast Routing Protocol Interaction*

RFC 5384, *The Protocol Independent Multicast (PIM) Join Attribute Format*

RFC 5496, *The Reverse Path Forwarding (RPF) Vector TLV*

RFC 6037, *Cisco Systems' Solution for Multicast in MPLS/BGP IP VPNs*

RFC 6512, *Using Multipoint LDP When the Backbone Has No Route to the Root*

RFC 6513, *Multicast in MPLS/BGP IP VPNs*
RFC 6514, *BGP Encodings and Procedures for Multicast in MPLS/IP VPNs*
RFC 6515, *IPv4 and IPv6 Infrastructure Addresses in BGP Updates for Multicast VPNs*
RFC 6516, *IPv6 Multicast VPN (MVPN) Support Using PIM Control Plane and Selective Provider Multicast Service Interface (S-PMSI) Join Messages*
RFC 6625, *Wildcards in Multicast VPN Auto-Discover Routes*
RFC 6826, *Multipoint LDP In-Band Signaling for Point-to-Multipoint and Multipoint-to-Multipoint Label Switched Path*
RFC 7246, *Multipoint Label Distribution Protocol In-Band Signaling in a Virtual Routing and Forwarding (VRF) Table Context*
RFC 7385, *IANA Registry for P-Multicast Service Interface (PMSI) Tunnel Type Code Points*
RFC 7716, *Global Table Multicast with BGP Multicast VPN (BGP-MVPN) Procedures*
RFC 7761, *Protocol Independent Multicast - Sparse Mode (PIM-SM): Protocol Specification (Revised)*
RFC 8279, *Multicast Using Bit Index Explicit Replication (BIER)*
RFC 8296, *Encapsulation for Bit Index Explicit Replication (BIER) in MPLS and Non-MPLS Networks – MPLS encapsulation*
RFC 8401, *Bit Index Explicit Replication (BIER) Support via IS-IS*
RFC 8444, *OSPFv2 Extensions for Bit Index Explicit Replication (BIER)*
RFC 8487, *Mtrace Version 2: Traceroute Facility for IP Multicast*
RFC 8534, *Explicit Tracking with Wildcard Routes in Multicast VPN – (C-*,C-*) wildcard*
RFC 8556, *Multicast VPN Using Bit Index Explicit Replication (BIER)*

15.15 Internet Protocol (IP) version 4

RFC 791, *Internet Protocol*
RFC 792, *Internet Control Message Protocol*
RFC 826, *An Ethernet Address Resolution Protocol*
RFC 951, *Bootstrap Protocol (BOOTP) – relay*
RFC 1034, *Domain Names - Concepts and Facilities*
RFC 1035, *Domain Names - Implementation and Specification*
RFC 1191, *Path MTU Discovery – router specification*
RFC 1519, *Classless Inter-Domain Routing (CIDR): an Address Assignment and Aggregation Strategy*
RFC 1534, *Interoperation between DHCP and BOOTP*
RFC 1542, *Clarifications and Extensions for the Bootstrap Protocol*
RFC 1812, *Requirements for IPv4 Routers*
RFC 1918, *Address Allocation for Private Internets*
RFC 2003, *IP Encapsulation within IP*

RFC 2131, *Dynamic Host Configuration Protocol*
RFC 2132, *DHCP Options and BOOTP Vendor Extensions*
RFC 2401, *Security Architecture for Internet Protocol*
RFC 3021, *Using 31-Bit Prefixes on IPv4 Point-to-Point Links*
RFC 3046, *DHCP Relay Agent Information Option (Option 82)*
RFC 3768, *Virtual Router Redundancy Protocol (VRRP)*
RFC 4884, *Extended ICMP to Support Multi-Part Messages – ICMPv4 and ICMPv6 Time Exceeded*

15.16 Internet Protocol (IP) version 6

RFC 2464, *Transmission of IPv6 Packets over Ethernet Networks*
RFC 2529, *Transmission of IPv6 over IPv4 Domains without Explicit Tunnels*
RFC 3122, *Extensions to IPv6 Neighbor Discovery for Inverse Discovery Specification*
RFC 3315, *Dynamic Host Configuration Protocol for IPv6 (DHCPv6)*
RFC 3587, *IPv6 Global Unicast Address Format*
RFC 3596, *DNS Extensions to Support IP version 6*
RFC 3633, *IPv6 Prefix Options for Dynamic Host Configuration Protocol (DHCP) version 6*
RFC 3646, *DNS Configuration options for Dynamic Host Configuration Protocol for IPv6 (DHCPv6)*
RFC 3736, *Stateless Dynamic Host Configuration Protocol (DHCP) Service for IPv6*
RFC 3971, *SEcure Neighbor Discovery (SEND)*
RFC 3972, *Cryptographically Generated Addresses (CGA)*
RFC 4007, *IPv6 Scoped Address Architecture*
RFC 4191, *Default Router Preferences and More-Specific Routes – Default Router Preference*
RFC 4193, *Unique Local IPv6 Unicast Addresses*
RFC 4291, *Internet Protocol Version 6 (IPv6) Addressing Architecture*
RFC 4443, *Internet Control Message Protocol (ICMPv6) for the Internet Protocol Version 6 (IPv6) Specification*
RFC 4861, *Neighbor Discovery for IP version 6 (IPv6)*
RFC 4862, *IPv6 Stateless Address Autoconfiguration – router functions*
RFC 4890, *Recommendations for Filtering ICMPv6 Messages in Firewalls*
RFC 4941, *Privacy Extensions for Stateless Address Autoconfiguration in IPv6*
RFC 5007, *DHCPv6 Leasequery*
RFC 5095, *Deprecation of Type 0 Routing Headers in IPv6*
RFC 5722, *Handling of Overlapping IPv6 Fragments*
RFC 5798, *Virtual Router Redundancy Protocol (VRRP) Version 3 for IPv4 and IPv6 – IPv6*
RFC 5952, *A Recommendation for IPv6 Address Text Representation*

RFC 6092, *Recommended Simple Security Capabilities in Customer Premises Equipment (CPE) for Providing Residential IPv6 Internet Service – Internet Control and Management, Upper-Layer Transport Protocols, UDP Filters, IPsec and Internet Key Exchange (IKE), TCP Filters*

RFC 6106, *IPv6 Router Advertisement Options for DNS Configuration*

RFC 6164, *Using 127-Bit IPv6 Prefixes on Inter-Router Links*

RFC 6221, *Lightweight DHCPv6 Relay Agent*

RFC 6437, *IPv6 Flow Label Specification*

RFC 6603, *Prefix Exclude Option for DHCPv6-based Prefix Delegation*

RFC 8021, *Generation of IPv6 Atomic Fragments Considered Harmful*

RFC 8200, *Internet Protocol, Version 6 (IPv6) Specification*

RFC 8201, *Path MTU Discovery for IP version 6*

15.17 Internet Protocol Security (IPsec)

draft-ietf-ipsec-isakmp-mode-cfg-05, *The ISAKMP Configuration Method*

draft-ietf-ipsec-isakmp-xauth-06, *Extended Authentication within ISAKMP/Oakley (XAUTH)*

RFC 2401, *Security Architecture for the Internet Protocol*

RFC 2403, *The Use of HMAC-MD5-96 within ESP and AH*

RFC 2404, *The Use of HMAC-SHA-1-96 within ESP and AH*

RFC 2405, *The ESP DES-CBC Cipher Algorithm With Explicit IV*

RFC 2406, *IP Encapsulating Security Payload (ESP)*

RFC 2407, *IPsec Domain of Interpretation for ISAKMP (IPsec DoI)*

RFC 2408, *Internet Security Association and Key Management Protocol (ISAKMP)*

RFC 2409, *The Internet Key Exchange (IKE)*

RFC 2410, *The NULL Encryption Algorithm and Its Use With IPsec*

RFC 2560, *X.509 Internet Public Key Infrastructure Online Certificate Status Protocol - OCSP*

RFC 3526, *More Modular Exponential (MODP) Diffie-Hellman group for Internet Key Exchange (IKE)*

RFC 3566, *The AES-XCBC-MAC-96 Algorithm and Its Use With IPsec*

RFC 3602, *The AES-CBC Cipher Algorithm and Its Use with IPsec*

RFC 3706, *A Traffic-Based Method of Detecting Dead Internet Key Exchange (IKE) Peers*

RFC 3947, *Negotiation of NAT-Traversal in the IKE*

RFC 3948, *UDP Encapsulation of IPsec ESP Packets*

RFC 4106, *The Use of Galois/Counter Mode (GCM) in IPsec ESP*

RFC 4109, *Algorithms for Internet Key Exchange version 1 (IKEv1)*

RFC 4301, *Security Architecture for the Internet Protocol*

RFC 4303, *IP Encapsulating Security Payload*

RFC 4307, *Cryptographic Algorithms for Use in the Internet Key Exchange Version 2 (IKEv2)*

RFC 4308, *Cryptographic Suites for IPsec*
RFC 4434, *The AES-XCBC-PRF-128 Algorithm for the Internet Key Exchange Protocol (IKE)*
RFC 4543, *The Use of Galois Message Authentication Code (GMAC) in IPsec ESP and AH*
RFC 4754, *IKE and IKEv2 Authentication Using the Elliptic Curve Digital Signature Algorithm (ECDSA)*
RFC 4835, *Cryptographic Algorithm Implementation Requirements for Encapsulating Security Payload (ESP) and Authentication Header (AH)*
RFC 4868, *Using HMAC-SHA-256, HMAC-SHA-384, and HMAC-SHA-512 with IPsec*
RFC 4945, *The Internet IP Security PKI Profile of IKEv1/ISAKMP, IKEv2 and PKIX*
RFC 5019, *The Lightweight Online Certificate Status Protocol (OCSP) Profile for High-Volume Environments*
RFC 5282, *Using Authenticated Encryption Algorithms with the Encrypted Payload of the IKEv2 Protocol*
RFC 5903, *ECP Groups for IKE and IKEv2*
RFC 5996, *Internet Key Exchange Protocol Version 2 (IKEv2)*
RFC 5998, *An Extension for EAP-Only Authentication in IKEv2*
RFC 6379, *Suite B Cryptographic Suites for IPsec*
RFC 6380, *Suite B Profile for Internet Protocol Security (IPsec)*
RFC 6960, *X.509 Internet Public Key Infrastructure Online Certificate Status Protocol - OCSP*
RFC 7296, *Internet Key Exchange Protocol Version 2 (IKEv2)*
RFC 7321, *Cryptographic Algorithm Implementation Requirements and Usage Guidance for Encapsulating Security Payload (ESP) and Authentication Header (AH)*
RFC 7383, *Internet Key Exchange Protocol Version 2 (IKEv2) Message Fragmentation*
RFC 7427, *Signature Authentication in the Internet Key Exchange Version 2 (IKEv2)*

15.18 Label Distribution Protocol (LDP)

draft-pdutta-mpls-ldp-adj-capability-00, *LDP Adjacency Capabilities*
draft-pdutta-mpls-ldp-v2-00, *LDP Version 2*
draft-pdutta-mpls-mlldp-up-redundancy-00, *Upstream LSR Redundancy for Multi-point LDP Tunnels*
draft-pdutta-mpls-multi-ldp-instance-00, *Multiple LDP Instances*
draft-pdutta-mpls-tldp-hello-reduce-04, *Targeted LDP Hello Reduction*
RFC 3037, *LDP Applicability*
RFC 3478, *Graceful Restart Mechanism for Label Distribution Protocol – helper mode*
RFC 5036, *LDP Specification*
RFC 5283, *LDP Extension for Inter-Area Label Switched Paths (LSPs)*
RFC 5443, *LDP IGP Synchronization*
RFC 5561, *LDP Capabilities*
RFC 5919, *Signaling LDP Label Advertisement Completion*

RFC 6388, *Label Distribution Protocol Extensions for Point-to-Multipoint and Multipoint-to-Multipoint Label Switched Paths*

RFC 6512, *Using Multipoint LDP When the Backbone Has No Route to the Root*

RFC 6826, *Multipoint LDP in-band signaling for Point-to-Multipoint and Multipoint-to-Multipoint Label Switched Paths*

RFC 7032, *LDP Downstream-on-Demand in Seamless MPLS*

RFC 7473, *Controlling State Advertisements of Non-negotiated LDP Applications*

RFC 7552, *Updates to LDP for IPv6*

15.19 Layer Two Tunneling Protocol (L2TP) Network Server (LNS)

draft-mammoliti-l2tp-accessline-avp-04, *Layer 2 Tunneling Protocol (L2TP) Access Line Information Attribute Value Pair (AVP) Extensions*

RFC 2661, *Layer Two Tunneling Protocol "L2TP"*

RFC 2809, *Implementation of L2TP Compulsory Tunneling via RADIUS*

RFC 3438, *Layer Two Tunneling Protocol (L2TP) Internet Assigned Numbers: Internet Assigned Numbers Authority (IANA) Considerations Update*

RFC 3931, *Layer Two Tunneling Protocol - Version 3 (L2TPv3)*

RFC 4719, *Transport of Ethernet Frames over Layer 2 Tunneling Protocol Version 3 (L2TPv3)*

RFC 4951, *Fail Over Extensions for Layer 2 Tunneling Protocol (L2TP) "failover"*

15.20 Multiprotocol Label Switching (MPLS)

draft-ietf-mpls-lsp-ping-ospfv3-codepoint-02, *OSPFv3 CodePoint for MPLS LSP Ping*

RFC 3031, *Multiprotocol Label Switching Architecture*

RFC 3032, *MPLS Label Stack Encoding*

RFC 3270, *Multi-Protocol Label Switching (MPLS) Support of Differentiated Services – E-LSP*

RFC 3443, *Time To Live (TTL) Processing in Multi-Protocol Label Switching (MPLS) Networks*

RFC 4023, *Encapsulating MPLS in IP or Generic Routing Encapsulation (GRE)*

RFC 4182, *Removing a Restriction on the use of MPLS Explicit NULL*

RFC 4950, *ICMP Extensions for Multiprotocol Label Switching*

RFC 5332, *MPLS Multicast Encapsulations*

RFC 5884, *Bidirectional Forwarding Detection (BFD) for MPLS Label Switched Paths (LSPs)*

RFC 6374, *Packet Loss and Delay Measurement for MPLS Networks – Delay Measurement, Channel Type 0x000C*

RFC 6424, *Mechanism for Performing Label Switched Path Ping (LSP Ping) over MPLS Tunnels*

RFC 6425, *Detecting Data Plane Failures in Point-to-Multipoint Multiprotocol Label Switching (MPLS) - Extensions to LSP Ping*

RFC 6790, *The Use of Entropy Labels in MPLS Forwarding*
RFC 7308, *Extended Administrative Groups in MPLS Traffic Engineering (MPLS-TE)*
RFC 7510, *Encapsulating MPLS in UDP*
RFC 7746, *Label Switched Path (LSP) Self-Ping*
RFC 7876, *UDP Return Path for Packet Loss and Delay Measurement for MPLS Networks – Delay Measurement*
RFC 8029, *Detecting Multiprotocol Label Switched (MPLS) Data-Plane Failures*

15.21 Multiprotocol Label Switching - Transport Profile (MPLS-TP)

RFC 5586, *MPLS Generic Associated Channel*
RFC 5921, *A Framework for MPLS in Transport Networks*
RFC 5960, *MPLS Transport Profile Data Plane Architecture*
RFC 6370, *MPLS Transport Profile (MPLS-TP) Identifiers*
RFC 6378, *MPLS Transport Profile (MPLS-TP) Linear Protection*
RFC 6426, *MPLS On-Demand Connectivity and Route Tracing*
RFC 6427, *MPLS Fault Management Operations, Administration, and Maintenance (OAM)*
RFC 6428, *Proactive Connectivity Verification, Continuity Check and Remote Defect indication for MPLS Transport Profile*
RFC 6478, *Pseudowire Status for Static Pseudowires*
RFC 7213, *MPLS Transport Profile (MPLS-TP) Next-Hop Ethernet Addressing*

15.22 Network Address Translation (NAT)

draft-ietf-behave-address-format-10, *IPv6 Addressing of IPv4/IPv6 Translators*
draft-ietf-behave-v6v4-xlate-23, *IP/ICMP Translation Algorithm*
draft-miles-behave-l2nat-00, *Layer2-Aware NAT*
draft-nishitani-cgn-02, *Common Functions of Large Scale NAT (LSN)*
RFC 4787, *Network Address Translation (NAT) Behavioral Requirements for Unicast UDP*
RFC 5382, *NAT Behavioral Requirements for TCP*
RFC 5508, *NAT Behavioral Requirements for ICMP*
RFC 6146, *Stateful NAT64: Network Address and Protocol Translation from IPv6 Clients to IPv4 Servers*
RFC 6333, *Dual-Stack Lite Broadband Deployments Following IPv4 Exhaustion*
RFC 6334, *Dynamic Host Configuration Protocol for IPv6 (DHCPv6) Option for Dual-Stack Lite*
RFC 6887, *Port Control Protocol (PCP)*
RFC 6888, *Common Requirements For Carrier-Grade NATs (CGNs)*
RFC 7753, *Port Control Protocol (PCP) Extension for Port-Set Allocation*

RFC 7915, *IP/ICMP Translation Algorithm*

15.23 Network Configuration Protocol (NETCONF)

RFC 5277, *NETCONF Event Notifications*

RFC 6020, *YANG - A Data Modeling Language for the Network Configuration Protocol (NETCONF)*

RFC 6022, *YANG Module for NETCONF Monitoring*

RFC 6241, *Network Configuration Protocol (NETCONF)*

RFC 6242, *Using the NETCONF Protocol over Secure Shell (SSH)*

RFC 6243, *With-defaults Capability for NETCONF*

RFC 8342, *Network Management Datastore Architecture (NMDA) – Startup, Candidate, Running and Intended datastores*

RFC 8525, *YANG Library*

RFC 8526, *NETCONF Extensions to Support the Network Management Datastore Architecture – <get-data> operation*

15.24 Open Shortest Path First (OSPF)

RFC 1765, *OSPF Database Overflow*

RFC 2328, *OSPF Version 2*

RFC 3101, *The OSPF Not-So-Stubby Area (NSSA) Option*

RFC 3509, *Alternative Implementations of OSPF Area Border Routers*

RFC 3623, *Graceful OSPF Restart Graceful OSPF Restart – helper mode*

RFC 3630, *Traffic Engineering (TE) Extensions to OSPF Version 2*

RFC 4222, *Prioritized Treatment of Specific OSPF Version 2 Packets and Congestion Avoidance*

RFC 4552, *Authentication/Confidentiality for OSPFv3*

RFC 4576, *Using a Link State Advertisement (LSA) Options Bit to Prevent Looping in BGP/MPLS IP Virtual Private Networks (VPNs)*

RFC 4577, *OSPF as the Provider/Customer Edge Protocol for BGP/MPLS IP Virtual Private Networks (VPNs)*

RFC 5185, *OSPF Multi-Area Adjacency*

RFC 5187, *OSPFv3 Graceful Restart – helper mode*

RFC 5243, *OSPF Database Exchange Summary List Optimization*

RFC 5250, *The OSPF Opaque LSA Option*

RFC 5309, *Point-to-Point Operation over LAN in Link State Routing Protocols*

RFC 5340, *OSPF for IPv6*

RFC 5642, *Dynamic Hostname Exchange Mechanism for OSPF*

RFC 5709, *OSPFv2 HMAC-SHA Cryptographic Authentication*
RFC 5838, *Support of Address Families in OSPFv3*
RFC 6549, *OSPFv2 Multi-Instance Extensions*
RFC 6987, *OSPF Stub Router Advertisement*
RFC 7471, *OSPF Traffic Engineering (TE) Metric Extensions – Min/Max Unidirectional Link Delay metric for flex-algo, RSVP, SR-TE*
RFC 7684, *OSPFv2 Prefix/Link Attribute Advertisement*
RFC 7770, *Extensions to OSPF for Advertising Optional Router Capabilities*
RFC 8362, *OSPFv3 Link State Advertisement (LSA) Extensibility*
RFC 8920, *OSPF Application-Specific Link Attributes*

15.25 OpenFlow

TS-007 Version 1.3.1, *OpenFlow Switch Specification* – OpenFlow-hybrid switches

15.26 Path Computation Element Protocol (PCEP)

draft-ietf-pce-binding-label-sid-15, *Carrying Binding Label/Segment Identifier (SID) in PCE-based Networks*. – MPLS binding SIDs
draft-alvarez-pce-path-profiles-04, *PCE Path Profiles*
draft-dhs-spring-pce-sr-p2mp-policy-00, *PCEP extensions for p2mp sr policy*
RFC 5440, *Path Computation Element (PCE) Communication Protocol (PCEP)*
RFC 8231, *Path Computation Element Communication Protocol (PCEP) Extensions for Stateful PCE*
RFC 8253, *PCEPS: Usage of TLS to Provide a Secure Transport for the Path Computation Element Communication Protocol (PCEP)*
RFC 8281, *PCEP Extensions for PCE-initiated LSP Setup in a Stateful PCE Model*
RFC 8408, *Conveying Path Setup Type in PCE Communication Protocol (PCEP) Messages*
RFC 8664, *Path Computation Element Communication Protocol (PCEP) Extensions for Segment Routing*

15.27 Point-to-Point Protocol (PPP)

RFC 1332, *The PPP Internet Protocol Control Protocol (IPCP)*
RFC 1990, *The PPP Multilink Protocol (MP)*
RFC 1994, *PPP Challenge Handshake Authentication Protocol (CHAP)*
RFC 2516, *A Method for Transmitting PPP Over Ethernet (PPPoE)*
RFC 4638, *Accommodating a Maximum Transit Unit/Maximum Receive Unit (MTU/MRU) Greater Than 1492 in the Point-to-Point Protocol over Ethernet (PPPoE)*

RFC 5072, *IP Version 6 over PPP*

15.28 Policy management and credit control

3GPP TS 29.212 Release 11, *Policy and Charging Control (PCC)*; Reference points – Gx support as it applies to wireline environment (BNG)

RFC 4006, *Diameter Credit-Control Application*

RFC 6733, *Diameter Base Protocol*

15.29 Pseudowire (PW)

draft-ietf-l2vpn-vpws-iw-oam-04, *OAM Procedures for VPWS Interworking*

MFA Forum 12.0.0, *Multiservice Interworking - Ethernet over MPLS*

MFA Forum 13.0.0, *Fault Management for Multiservice Interworking v1.0*

MFA Forum 16.0.0, *Multiservice Interworking - IP over MPLS*

RFC 3916, *Requirements for Pseudo-Wire Emulation Edge-to-Edge (PWE3)*

RFC 3985, *Pseudo Wire Emulation Edge-to-Edge (PWE3)*

RFC 4385, *Pseudo Wire Emulation Edge-to-Edge (PWE3) Control Word for Use over an MPLS PSN*

RFC 4446, *IANA Allocations for Pseudowire Edge to Edge Emulation (PWE3)*

RFC 4447, *Pseudowire Setup and Maintenance Using the Label Distribution Protocol (LDP)*

RFC 4448, *Encapsulation Methods for Transport of Ethernet over MPLS Networks*

RFC 5085, *Pseudowire Virtual Circuit Connectivity Verification (VCCV): A Control Channel for Pseudowires*

RFC 5659, *An Architecture for Multi-Segment Pseudowire Emulation Edge-to-Edge*

RFC 5885, *Bidirectional Forwarding Detection (BFD) for the Pseudowire Virtual Circuit Connectivity Verification (VCCV)*

RFC 6073, *Segmented Pseudowire*

RFC 6310, *Pseudowire (PW) Operations, Administration, and Maintenance (OAM) Message Mapping*

RFC 6391, *Flow-Aware Transport of Pseudowires over an MPLS Packet Switched Network*

RFC 6575, *Address Resolution Protocol (ARP) Mediation for IP Interworking of Layer 2 VPNs*

RFC 6718, *Pseudowire Redundancy*

RFC 6829, *Label Switched Path (LSP) Ping for Pseudowire Forwarding Equivalence Classes (FECs) Advertised over IPv6*

RFC 6870, *Pseudowire Preferential Forwarding Status bit*

RFC 7023, *MPLS and Ethernet Operations, Administration, and Maintenance (OAM) Interworking*

RFC 7267, *Dynamic Placement of Multi-Segment Pseudowires*

RFC 7392, *Explicit Path Routing for Dynamic Multi-Segment Pseudowires – ER-TLV and ER-HOP IPv4 Prefix*

RFC 8395, *Extensions to BGP-Signaled Pseudowires to Support Flow-Aware Transport Labels*

15.30 Quality of Service (QoS)

RFC 2430, *A Provider Architecture for Differentiated Services and Traffic Engineering (PASTE)*

RFC 2474, *Definition of the Differentiated Services Field (DS Field) in the IPv4 and IPv6 Headers*

RFC 2597, *Assured Forwarding PHB Group*

RFC 3140, *Per Hop Behavior Identification Codes*

RFC 3246, *An Expedited Forwarding PHB (Per-Hop Behavior)*

15.31 Remote Authentication Dial In User Service (RADIUS)

draft-oscca-cfrg-sm3-02, *The SM3 Cryptographic Hash Function*

RFC 2865, *Remote Authentication Dial In User Service (RADIUS)*

RFC 2866, *RADIUS Accounting*

RFC 2867, *RADIUS Accounting Modifications for Tunnel Protocol Support*

RFC 2868, *RADIUS Attributes for Tunnel Protocol Support*

RFC 2869, *RADIUS Extensions*

RFC 3162, *RADIUS and IPv6*

RFC 4818, *RADIUS Delegated-IPv6-Prefix Attribute*

RFC 5176, *Dynamic Authorization Extensions to RADIUS*

RFC 6613, *RADIUS over TCP – with TLS*

RFC 6614, *Transport Layer Security (TLS) Encryption for RADIUS*

RFC 6929, *Remote Authentication Dial-In User Service (RADIUS) Protocol Extensions*

RFC 6911, *RADIUS attributes for IPv6 Access Networks*

15.32 Resource Reservation Protocol - Traffic Engineering (RSVP-TE)

draft-newton-mpls-te-dynamic-overbooking-00, *A Diffserv-TE Implementation Model to dynamically change booking factors during failure events*

RFC 2702, *Requirements for Traffic Engineering over MPLS*

RFC 2747, *RSVP Cryptographic Authentication*

RFC 2961, *RSVP Refresh Overhead Reduction Extensions*

RFC 3097, *RSVP Cryptographic Authentication -- Updated Message Type Value*

RFC 3209, *RSVP-TE: Extensions to RSVP for LSP Tunnels*

RFC 3477, *Signalling Unnumbered Links in Resource ReSerVation Protocol - Traffic Engineering (RSVP-TE)*

RFC 3564, *Requirements for Support of Differentiated Services-aware MPLS Traffic Engineering*
RFC 3906, *Calculating Interior Gateway Protocol (IGP) Routes Over Traffic Engineering Tunnels*
RFC 4090, *Fast Reroute Extensions to RSVP-TE for LSP Tunnels*
RFC 4124, *Protocol Extensions for Support of Diffserv-aware MPLS Traffic Engineering*
RFC 4125, *Maximum Allocation Bandwidth Constraints Model for Diffserv-aware MPLS Traffic Engineering*
RFC 4127, *Russian Dolls Bandwidth Constraints Model for Diffserv-aware MPLS Traffic Engineering*
RFC 4561, *Definition of a Record Route Object (RRO) Node-Id Sub-Object*
RFC 4875, *Extensions to Resource Reservation Protocol - Traffic Engineering (RSVP-TE) for Point-to-Multipoint TE Label Switched Paths (LSPs)*
RFC 5712, *MPLS Traffic Engineering Soft Preemption*
RFC 5817, *Graceful Shutdown in MPLS and Generalized MPLS Traffic Engineering Networks*

15.33 Routing Information Protocol (RIP)

RFC 1058, *Routing Information Protocol*
RFC 2080, *RIPng for IPv6*
RFC 2082, *RIP-2 MD5 Authentication*
RFC 2453, *RIP Version 2*

15.34 Segment Routing (SR)

draft-ietf-bess-mvpn-evpn-sr-p2mp-07, *Multicast and Ethernet VPN with Segment Routing P2MP and Ingress Replication – MVPN*
draft-bashandy-rtgwg-segment-routing-uloop-15, *Loop avoidance using Segment Routing*
draft-filsfils-spring-net-pgm-extension-srv6-usid-15, *Network Programming extension: SRv6 uSID instruction*
draft-filsfils-spring-srv6-net-pgm-insertion-08, *SRv6 NET-PGM extension: Insertion*
draft-ietf-idr-bgppls-srv6-ext-14, *BGP Link State Extensions for SRv6*
draft-ietf-idr-segment-routing-te-policy-23, *Advertising Segment Routing Policies in BGP*
draft-ietf-idr-ts-flowspec-srv6-policy-03, *Traffic Steering using BGP FlowSpec with SR Policy*
draft-ietf-pim-p2mp-policy-ping-03, *P2MP Policy Ping*
draft-ietf-pim-sr-p2mp-policy-06, *Segment Routing Point-to-Multipoint Policy – MPLS*
draft-ietf-rtgwg-segment-routing-ti-lfa-11, *Topology Independent Fast Reroute using Segment Routing*
draft-ietf-spring-conflict-resolution-05, *Segment Routing MPLS Conflict Resolution*
draft-ietf-spring-sr-replication-segment-16, *SR Replication segment for Multi-point Service Delivery – MPLS*
draft-ietf-spring-srv6-srh-compression-xx, *Compressed SRv6 Segment List Encoding in SRH*

draft-voyer-6man-extension-header-insertion-10, *Deployments With Insertion of IPv6 Segment Routing Headers*

RFC 8287, *Label Switched Path (LSP) Ping/Traceroute for Segment Routing (SR) IGP-Prefix and IGP-Adjacency Segment Identifiers (SIDs) with MPLS Data Planes*

RFC 8426, *Recommendations for RSVP-TE and Segment Routing (SR) Label Switched Path (LSP) Coexistence*

RFC 8476, *Signaling Maximum SID Depth (MSD) Using OSPF – node MSD*

RFC 8491, *Signaling Maximum SID Depth (MSD) Using IS-IS – node MSD*

RFC 8660, *Segment Routing with the MPLS Data Plane*

RFC 8661, *Segment Routing MPLS Interworking with LDP*

RFC 8663, *MPLS Segment Routing over IP – BGP SR with SR-MPLS-over-UDP/IP*

RFC 8665, *OSPF Extensions for Segment Routing*

RFC 8666, *OSPFv3 Extensions for Segment Routing*

RFC 8667, *IS-IS Extensions for Segment Routing*

RFC 8669, *Segment Routing Prefix Segment Identifier Extensions for BGP*

RFC 8754, *IPv6 Segment Routing Header (SRH)*

RFC 8814, *Signaling Maximum SID Depth (MSD) Using the Border Gateway Protocol - Link State*

RFC 8986, *Segment Routing over IPv6 (SRv6) Network Programming*

RFC 9085, *Border Gateway Protocol - Link State (BGP-LS) Extensions for Segment Routing*

RFC 9088, *Signaling Entropy Label Capability and Entropy Readable Label Depth Using IS-IS – advertising ELC*

RFC 9089, *Signaling Entropy Label Capability and Entropy Readable Label Depth Using OSPF – advertising ELC*

RFC 9252, *BGP Overlay Services Based on Segment Routing over IPv6 (SRv6)*

RFC 9256, *Segment Routing Policy Architecture*

RFC 9259, *Operations, Administration, and Maintenance (OAM) in Segment Routing over IPv6 (SRv6)*

RFC 9350, *IGP Flexible Algorithm*

RFC 9352, *IS-IS Extensions to Support Segment Routing over the IPv6 Data Plane*

15.35 Simple Network Management Protocol (SNMP)

draft-blumenthal-aes-usm-04, *The AES Cipher Algorithm in the SNMP's User-based Security Model – CFB128-AES-192 and CFB128-AES-256*

draft-ietf-isis-wg-mib-06, *Management Information Base for Intermediate System to Intermediate System (IS-IS)*

draft-ietf-mboned-msdp-mib-01, *Multicast Source Discovery protocol MIB*

draft-ietf-mpls-ldp-mib-07, *Definitions of Managed Objects for the Multiprotocol Label Switching, Label Distribution Protocol (LDP)*

draft-ietf-mpls-lsr-mib-06, Multiprotocol Label Switching (MPLS) Label Switching Router (LSR) Management Information Base Using SMIv2

draft-ietf-mpls-te-mib-04, Multiprotocol Label Switching (MPLS) Traffic Engineering Management Information Base

draft-ietf-ospf-mib-update-08, OSPF Version 2 Management Information Base

draft-ietf-rrrp-unified-mib-06, Definitions of Managed Objects for the VRRP over IPv4 and IPv6 – IPv6

ESO-CONSORTIUM-MIB revision 200406230000Z, esoConsortiumMIB

IANA-ADDRESS-FAMILY-NUMBERS-MIB revision 200203140000Z, ianaAddressFamilyNumbers

IANAifType-MIB revision 200505270000Z, ianaifType

IANA-RTPROTO-MIB revision 200009260000Z, ianaRtProtoMIB

IEEE8021-CFM-MIB revision 200706100000Z, ieee8021CfmMib

IEEE8021-PAE-MIB revision 200101160000Z, ieee8021paeMIB

IEEE8023-LAG-MIB revision 200006270000Z, lagMIB

LLDP-MIB revision 200505060000Z, lldpMIB

RFC 1157, A Simple Network Management Protocol (SNMP)

RFC 1212, Concise MIB Definitions

RFC 1215, A Convention for Defining Traps for use with the SNMP

RFC 1724, RIP Version 2 MIB Extension

RFC 1901, Introduction to Community-based SNMPv2

RFC 2021, Remote Network Monitoring Management Information Base Version 2 using SMIv2

RFC 2206, RSVP Management Information Base using SMIv2

RFC 2213, Integrated Services Management Information Base using SMIv2

RFC 2494, Definitions of Managed Objects for the DS0 and DS0 Bundle Interface Type

RFC 2578, Structure of Management Information Version 2 (SMIv2)

RFC 2579, Textual Conventions for SMIv2

RFC 2580, Conformance Statements for SMIv2

RFC 2787, Definitions of Managed Objects for the Virtual Router Redundancy Protocol

RFC 2819, Remote Network Monitoring Management Information Base

RFC 2856, Textual Conventions for Additional High Capacity Data Types

RFC 2863, The Interfaces Group MIB

RFC 2864, The Inverted Stack Table Extension to the Interfaces Group MIB

RFC 2933, Internet Group Management Protocol MIB

RFC 3014, Notification Log MIB

RFC 3165, Definitions of Managed Objects for the Delegation of Management Scripts

RFC 3231, Definitions of Managed Objects for Scheduling Management Operations

RFC 3273, Remote Network Monitoring Management Information Base for High Capacity Networks

RFC 3410, Introduction and Applicability Statements for Internet Standard Management Framework

RFC 3411, *An Architecture for Describing Simple Network Management Protocol (SNMP) Management Frameworks*

RFC 3412, *Message Processing and Dispatching for the Simple Network Management Protocol (SNMP)*

RFC 3413, *Simple Network Management Protocol (SNMP) Applications*

RFC 3414, *User-based Security Model (USM) for version 3 of the Simple Network Management Protocol (SNMPv3)*

RFC 3415, *View-based Access Control Model (VACM) for the Simple Network Management Protocol (SNMP)*

RFC 3416, *Version 2 of the Protocol Operations for the Simple Network Management Protocol (SNMP)*

RFC 3417, *Transport Mappings for the Simple Network Management Protocol (SNMP) – SNMP over UDP over IPv4*

RFC 3418, *Management Information Base (MIB) for the Simple Network Management Protocol (SNMP)*

RFC 3419, *Textual Conventions for Transport Addresses*

RFC 3498, *Definitions of Managed Objects for Synchronous Optical Network (SONET) Linear Automatic Protection Switching (APS) Architectures*

RFC 3584, *Coexistence between Version 1, Version 2, and Version 3 of the Internet-standard Network Management Framework*

RFC 3592, *Definitions of Managed Objects for the Synchronous Optical Network/Synchronous Digital Hierarchy (SONET/SDH) Interface Type*

RFC 3593, *Textual Conventions for MIB Modules Using Performance History Based on 15 Minute Intervals*

RFC 3635, *Definitions of Managed Objects for the Ethernet-like Interface Types*

RFC 3637, *Definitions of Managed Objects for the Ethernet WAN Interface Sublayer*

RFC 3826, *The Advanced Encryption Standard (AES) Cipher Algorithm in the SNMP User-based Security Model*

RFC 3877, *Alarm Management Information Base (MIB)*

RFC 3895, *Definitions of Managed Objects for the DS1, E1, DS2, and E2 Interface Types*

RFC 3896, *Definitions of Managed Objects for the DS3/E3 Interface Type*

RFC 4001, *Textual Conventions for Internet Network Addresses*

RFC 4022, *Management Information Base for the Transmission Control Protocol (TCP)*

RFC 4113, *Management Information Base for the User Datagram Protocol (UDP)*

RFC 4220, *Traffic Engineering Link Management Information Base*

RFC 4273, *Definitions of Managed Objects for BGP-4*

RFC 4292, *IP Forwarding Table MIB*

RFC 4293, *Management Information Base for the Internet Protocol (IP)*

RFC 4631, *Link Management Protocol (LMP) Management Information Base (MIB)*

RFC 4878, *Definitions and Managed Objects for Operations, Administration, and Maintenance (OAM) Functions on Ethernet-Like Interfaces*

RFC 7420, *Path Computation Element Communication Protocol (PCEP) Management Information Base (MIB) Module*

RFC 7630, *HMAC-SHA-2 Authentication Protocols in the User-based Security Model (USM) for SNMPv3*
SFLOW-MIB revision 200309240000Z, *sFlowMIB*

15.36 Timing

GR-1244-CORE Issue 3, *Clocks for the Synchronized Network: Common Generic Criteria*
GR-253-CORE Issue 3, *SONET Transport Systems: Common Generic Criteria*
IEEE 1588-2008, *IEEE Standard for a Precision Clock Synchronization Protocol for Networked Measurement and Control Systems*
ITU-T G.781, *Synchronization layer functions*
ITU-T G.811, *Timing characteristics of primary reference clocks*
ITU-T G.813, *Timing characteristics of SDH equipment slave clocks (SEC)*
ITU-T G.8261, *Timing and synchronization aspects in packet networks*
ITU-T G.8262, *Timing characteristics of synchronous Ethernet equipment slave clock (EEC)*
ITU-T G.8262.1, *Timing characteristics of an enhanced synchronous Ethernet equipment slave clock (eEEC)*
ITU-T G.8264, *Distribution of timing information through packet networks*
ITU-T G.8265.1, *Precision time protocol telecom profile for frequency synchronization*
ITU-T G.8272, *Timing characteristics of primary reference time clocks – PRTC-A, PRTC-B*
ITU-T G.8275.1, *Precision time protocol telecom profile for phase/time synchronization with full timing support from the network*
ITU-T G.8275.2, *Precision time protocol telecom profile for phase/time synchronization with partial timing support from the network*
RFC 3339, *Date and Time on the Internet: Timestamps*
RFC 5905, *Network Time Protocol Version 4: Protocol and Algorithms Specification*

15.37 Two-Way Active Measurement Protocol (TWAMP)

RFC 5357, *A Two-Way Active Measurement Protocol (TWAMP) – server, unauthenticated mode*
RFC 5938, *Individual Session Control Feature for the Two-Way Active Measurement Protocol (TWAMP)*
RFC 6038, *Two-Way Active Measurement Protocol (TWAMP) Reflect Octets and Symmetrical Size Features*
RFC 8545, *Well-Known Port Assignments for the One-Way Active Measurement Protocol (OWAMP) and the Two-Way Active Measurement Protocol (TWAMP) – TWAMP*
RFC 8762, *Simple Two-Way Active Measurement Protocol – unauthenticated*
RFC 8972, *Simple Two-Way Active Measurement Protocol Optional Extensions – unauthenticated*

15.38 Virtual Private LAN Service (VPLS)

RFC 4761, *Virtual Private LAN Service (VPLS) Using BGP for Auto-Discovery and Signaling*
RFC 4762, *Virtual Private LAN Service (VPLS) Using Label Distribution Protocol (LDP) Signaling*
RFC 5501, *Requirements for Multicast Support in Virtual Private LAN Services*
RFC 6074, *Provisioning, Auto-Discovery, and Signaling in Layer 2 Virtual Private Networks (L2VPNs)*
RFC 7041, *Extensions to the Virtual Private LAN Service (VPLS) Provider Edge (PE) Model for Provider Backbone Bridging*
RFC 7117, *Multicast in Virtual Private LAN Service (VPLS)*

15.39 Voice and video

DVB BlueBook A86, *Transport of MPEG-2 TS Based DVB Services over IP Based Networks*
ETSI TS 101 329-5 Annex E, *QoS Measurement for VoIP - Method for determining an Equipment Impairment Factor using Passive Monitoring*
ITU-T G.1020 Appendix I, *Performance Parameter Definitions for Quality of Speech and other Voiceband Applications Utilizing IP Networks - Mean Absolute Packet Delay Variation & Markov Models*
ITU-T G.107, *The E Model - A computational model for use in planning*
ITU-T P.564, *Conformance testing for voice over IP transmission quality assessment models*
RFC 3550, *RTP: A Transport Protocol for Real-Time Applications – Appendix A.8*
RFC 4585, *Extended RTP Profile for Real-time Transport Control Protocol (RTCP)-Based Feedback (RTP/AVPF)*
RFC 4588, *RTP Retransmission Payload Format*

15.40 Wireless Local Area Network (WLAN) gateway

3GPP TS 23.402, *Architecture enhancements for non-3GPP accesses – S2a roaming based on GPRS*

15.41 Yet Another Next Generation (YANG)

RFC 6991, *Common YANG Data Types*
RFC 7950, *The YANG 1.1 Data Modeling Language*
RFC 7951, *JSON Encoding of Data Modeled with YANG*

15.42 Yet Another Next Generation (YANG) OpenConfig Models

openconfig-aaa.yang version 0.4.0, *OpenConfig AAA Model*
openconfig-aaa-radius.yang version 0.3.0, *OpenConfig AAA RADIUS Model*

openconfig-aaa-tacacs.yang version 0.3.0, *OpenConfig AAA TACACS+ Model*
openconfig-acl.yang version 1.0.0, *OpenConfig ACL Model*
openconfig-alarms.yang version 0.3.2, *OpenConfig System Alarms Model*
openconfig-bfd.yang version 0.2.2, *OpenConfig BFD Model*
openconfig-bgp.yang version 6.1.0, *OpenConfig BGP Model*
openconfig-bgp-common.yang version 6.0.0, *OpenConfig BGP Common Model*
openconfig-bgp-common-multiprotocol.yang version 6.0.0, *OpenConfig BGP Common Multiprotocol Model*
openconfig-bgp-common-structure.yang version 6.0.0, *OpenConfig BGP Common Structure Model*
openconfig-bgp-global.yang version 6.0.0, *OpenConfig BGP Global Model*
openconfig-bgp-neighbor.yang version 6.1.0, *OpenConfig BGP Neighbor Model*
openconfig-bgp-peer-group.yang version 6.1.0, *OpenConfig BGP Peer Group Model*
openconfig-bgp-policy.yang version 4.0.1, *OpenConfig BGP Policy Model*
openconfig-if-aggregate.yang version 2.4.3, *OpenConfig Interfaces Aggregated Model*
openconfig-if-ethernet.yang version 2.12.1, *OpenConfig Interfaces Ethernet Model*
openconfig-if-ip.yang version 3.1.0, *OpenConfig Interfaces IP Model*
openconfig-if-ip-ext.yang version 2.3.1, *OpenConfig Interfaces IP Extensions Model*
openconfig-igmp.yang version 0.2.0, *OpenConfig IGMP Model*
openconfig-interfaces.yang version 3.0.0, *OpenConfig Interfaces Model*
openconfig-isis.yang version 1.1.0, *OpenConfig IS-IS Model*
openconfig-isis-policy.yang version 0.5.0, *OpenConfig IS-IS Policy Model*
openconfig-isis-routing.yang version 1.1.0, *OpenConfig IS-IS Routing Model*
openconfig-lacp.yang version 1.3.0, *OpenConfig LACP Model*
openconfig-lldp.yang version 0.1.0, *OpenConfig LLDP Model*
openconfig-local-routing.yang version 1.2.0, *OpenConfig Local Routing Model*
openconfig-mpls.yang version 2.3.0, *OpenConfig MPLS Model*
openconfig-mpls-ldp.yang version 3.0.2, *OpenConfig MPLS LDP Model*
openconfig-mpls-rsvp.yang version 2.3.0, *OpenConfig MPLS RSVP Model*
openconfig-mpls-te.yang version 2.3.0, *OpenConfig MPLS TE Model*
openconfig-network-instance.yang version 1.1.0, *OpenConfig Network Instance Model*
openconfig-network-instance-l3.yang version 0.11.1, *OpenConfig L3 Network Instance Model – static routes*
openconfig-ospfv2.yang version 0.4.0, *OpenConfig OSPFv2 Model*
openconfig-ospfv2-area.yang version 0.4.0, *OpenConfig OSPFv2 Area Model*
openconfig-ospfv2-area-interface.yang version 0.4.0, *OpenConfig OSPFv2 Area Interface Model*
openconfig-ospfv2-common.yang version 0.4.0, *OpenConfig OSPFv2 Common Model*
openconfig-ospfv2-global.yang version 0.4.0, *OpenConfig OSPFv2 Global Model*
openconfig-packet-match.yang version 1.0.0, *OpenConfig Packet Match Model*

openconfig-pim.yang version 0.2.0, *OpenConfig PIM Model*
openconfig-platform.yang version 0.15.0, *OpenConfig Platform Model*
openconfig-platform-fan.yang version 0.1.1, *OpenConfig Platform Fan Model*
openconfig-platform-linecard.yang version 0.1.2, *OpenConfig Platform Linecard Model*
openconfig-platform-port.yang version 0.4.2, *OpenConfig Port Model*
openconfig-platform-transceiver.yang version 0.9.0, *OpenConfig Transceiver Model*
openconfig-procmon.yang version 0.4.0, *OpenConfig Process Monitoring Model*
openconfig-relay-agent.yang version 0.1.0, *OpenConfig Relay Agent Model*
openconfig-routing-policy.yang version 3.0.0, *OpenConfig Routing Policy Model*
openconfig-rsvp-sr-ext.yang version 0.1.0, *OpenConfig RSVP-TE and SR Extensions Model*
openconfig-system.yang version 0.10.1, *OpenConfig System Model*
openconfig-system-grpc.yang version 1.0.0, *OpenConfig System gRPC Model*
openconfig-system-logging.yang version 0.3.1, *OpenConfig System Logging Model*
openconfig-system-terminal.yang version 0.3.0, *OpenConfig System Terminal Model*
openconfig-telemetry.yang version 0.5.0, *OpenConfig Telemetry Model*
openconfig-terminal-device.yang version 1.9.0, *OpenConfig Terminal Optics Device Model*
openconfig-vlan.yang version 2.0.0, *OpenConfig VLAN Model*

Customer document and product support



Customer documentation

[Customer documentation welcome page](#)



Technical support

[Product support portal](#)



Documentation feedback

[Customer documentation feedback](#)